













CARE AND MAINTENANCE

Always use felt pads under all articles to prevent discoloration or softening of the lacquer. Plastic and rubber bases on items can discolor wood. Wipe up spills immediately and avoid common hazards such as hot dishes, harsh solvents and abrasives. Cleaning should be done with a soft lint free cotton cloth dampened with water or furniture polish. On highly used surfaces we recommend applying a quality paste wax which should be used on a regular basis to provide additional protection from scratches and spills. How often you apply the wax depends on how much wear the furniture receives.

NOTICE

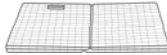
- * Please make sure that you have all parts indicated before you begin assembly of this item
- * This item should be assembled on a soft surface to prevent scratching the finish during assembly
- * This item may require periodic tightening

Part List

PIECE	DESCRIPTION	PICTURE	QUANTITY	PIECE	DESCRIPTION	PICTURE	QUANTITY
A	Table Top		1X	B	Right Middle Panel		1X
C	Left Middle Panel		1X	D	Right Side Panel		1X
E	Left Side Panel		1X	F	Back Panel		1X
G	Bottom Panel		1X	H	Cushion		1X
I	Basket Frame		1X	J	Basket Bottom		1X
K	Longer Screw		16X	L	Allan Key Driver		1X
M	Shorter Screw		12X				



Item#AMH5733

Product Dimensions: 47" W x 16" D x 20.25" H

ATTACH YOUR RECEIPT HERE

Serial Number _____

Purchase Date _____

Additional Tools Required

	Screwdriver (not include)
---	---------------------------

PREPARATION

Before beginning assembly of product, make sure all parts are present. Compare parts with package contents list

If any part is missing or damaged, do not attempt to assemble the product.

Estimated Assembly Time: 5 minutes.

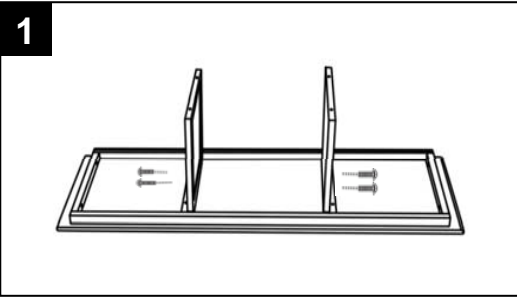

Step 1

Put the bench top(A) upside down, attached the middle panel (B) and (C) to the bench top (A) by using 4pc longer screws(K).

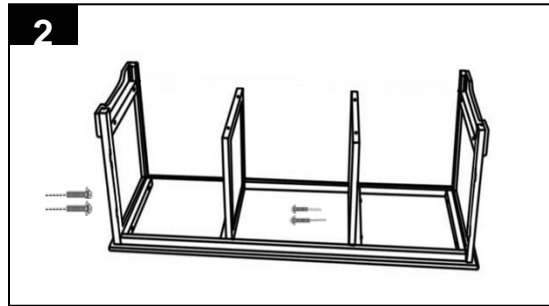

Step 2

Attached the right panel (D) and left panel (E) to the bench top(A) by using 4pc longer screws (K).

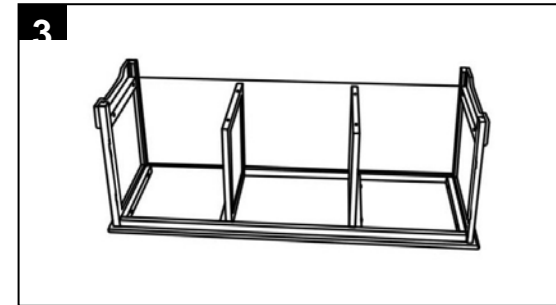

Step 3

Insert the back panel (F) to the groove of the left panel(E) and right panel(D).

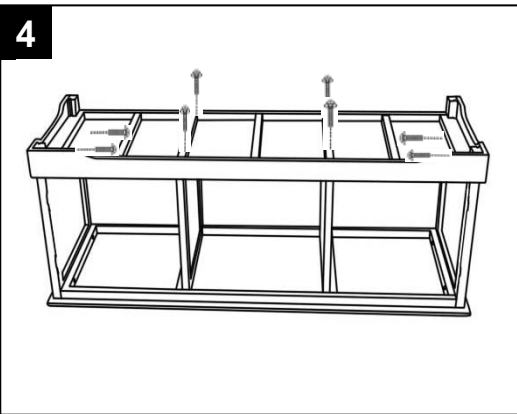

Step 4

Put the bottom panel(G) over the back panel(F) middle panel(B)&(C),make sure back panel(F) insert the bottom groove of bottom panel(G). Using 8screws(K) to connect bottom panel(G) with middle panel(B)&(C), right and left panel(D)&(E).

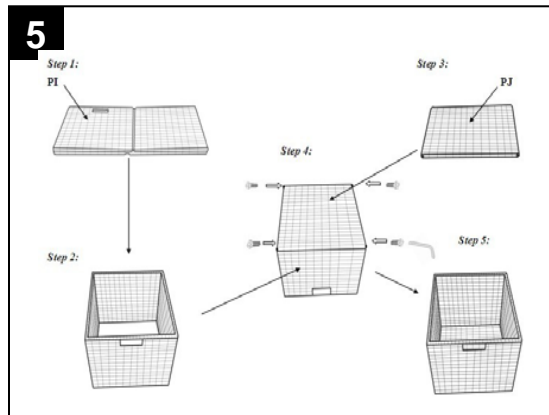

Step 5

Open up the basket frame(I), attach the basket bottom(J) to basket frame(I) by using 4 Shorter Screws(M) and Allan Key Driver (L).



Step 6

Now Turn the bench to right side. Put on the cushion and baskets.