

W33509C24

D4" H5.5" L9



We are dedicated to providing the finest quality crystal luminaires for our customers. Our master craftsmen and designers pride themselves on their attention to detail. Prompt, efficient service is always our priority.

Enclosed herein are detailed instructions on how to properly install your ceiling light. Please read all instructions carefully and thoroughly.

If you have missing or damaged parts, we'll replace them for you at no cost. Call our toll free number at:

1-855-411-8999



Crystal Dressing Instructions

When dressing the chandelier with the crystals please remember to wear either rubber or cotton gloves. So as to prevent any damage or smudging on the crystals.

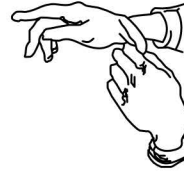

A

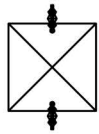

22#*1pcs

B

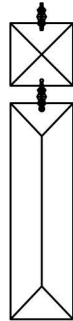

22#*1pcs+22x63#*1pcs

C



30#

09

NO.	Quantity
A	72 string
B	72 strings
C	169 strings

CANOPY PARTS LIST

Existing Electrical Box

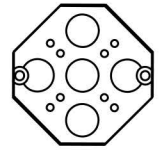

Crossbar

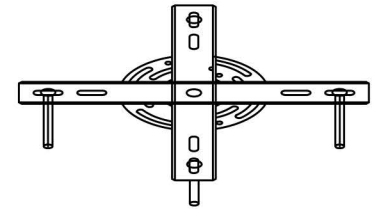

Crossbar Screws x 2(not supplied)



Wire Connector



Shrinkable tube

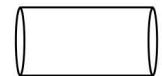

Cable tie



Ground Wire



02

CANOPY INSTALLATION DIAGRAM

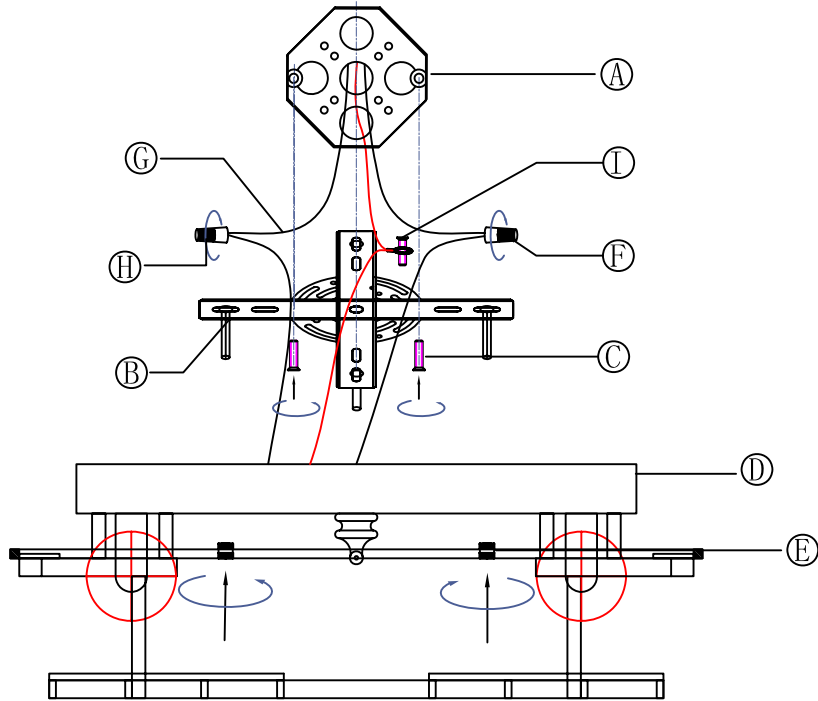

07

Frame Parts List

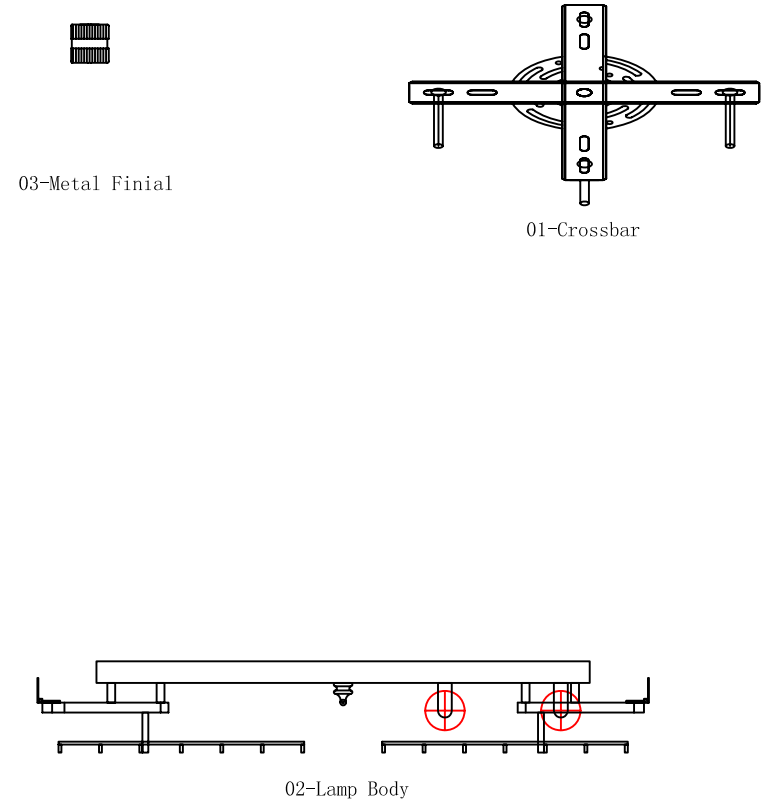

04

WARNING!!!

**CONTENTS ARE FRAGILE
HANDLE WITH CARE**

The metal frame and crystal components of this chandelier are very delicate. Please exercise extreme Caution during unpacking and installation.

WARNING!!!

After passing the main electrical wire through the 10mm pipe and connecting the pipe to the main body top connector, place all remaining pieces as shown in numerical order and in the orientation depicted. Refer to the parts list to avoid confusion between parts. The part Numbers coincide

CAUTION

- 1) Assembly & installation should be done by a qualified, licensed professional (electrician) only, and in compliance with the National Electric Code, local, and all other building and electrical codes. Worldwide Lighting's limited 1-yr. warranty is voided, and the firm is not responsible for damages or other issues, if appliance is installed by unlicensed parties
- 2) Lighting fixture is rated for 110 - 130v /60Hz. Bulbs are E12 (candelabra) base, 25 watt maximum. **IMPORTANT:** Note that on installation, fixture must be grounded.
- 3) Please keep lighting away from acids, alkali and other corrosive chemicals, gas and cleaning solutions. Clean only with a clean, soft cloth.
- 4) Never install lighting on a damp ceiling or surface. The room should be dry and well ventilated.
- 5) **IMPORTANT.** Precautions must be taken to support the fixture's full weight, independent of the ceiling-mounted junction box (typically rated for only 25 lbs.). This may require steel cables or strapping, heavy-duty bolts and hardware, and a strong, secure mounting surface independent of roofs and false or suspended ceilings. A licensed, professional contractor is the most qualified to determine proper mounting, particularly with respect to individual site conditions.
- 6) Care should be taken to avoid damage to the surface of lighting components and wiring during assembly & installation. To avoid smudging and other issues, we recommend wearing rubber or cotton gloves throughout the assembly / installation process.

Crystal Dressing Diagram



When dressing the chandelier with the crystals please remember to wear either rubber or cotton gloves. So as to prevent any damage or smudging on the crystals.

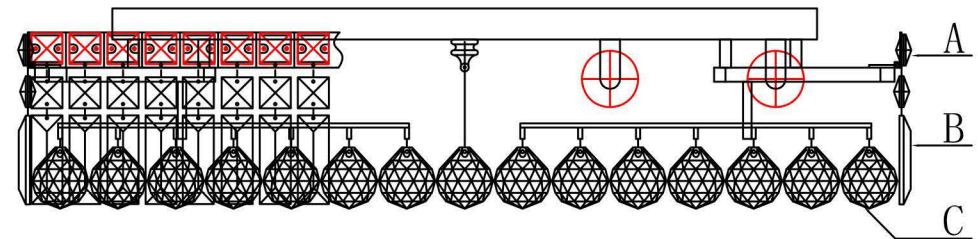

Frame Assembly Diagram

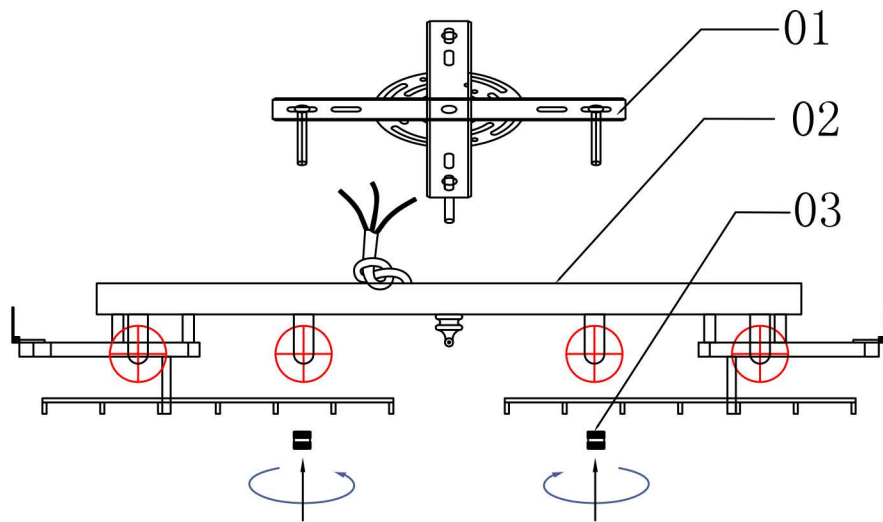

03

CANOPY INSTALLATION INSTRUCTIONS

Please read all instructions carefully. Before you proceed to install, make sure that the power supply is turned off and off until installation is complete. Please note that each part has been assigned a letter. Please proceed in an alphabetical order.

- A. Existing Electrical Box
- B. Crossbar
- C. Crossbar Screws
- D. Metal Plate
- E. Crossbar Bracket
- F. Neutral Conductor
- G. Hot Wire
- H. Junction Caps
- I. Ground Wire

Attach the Crossbar (B) to the existing electrical box (A) using the two crossbar screws (E) which are not supplied and should already be in your box.

08

WARNING!!!
CONTENTS ARE FRAGILE
HANDLE WITH CARE

The metal frame and crystal components of this chandelier are very delicate. Please exercise extreme Caution during unpacking and installation.

WARNING!!!

After passing the main electrical wire through the 10mm pipe and connecting the pipe to the main body top connector, place all remaining pieces as shown in numerical order and in the orientation depicted. Refer to the parts list to avoid confusion between parts. The part Numbers coincide

CAUTION

- 1) Assembly & installation should be done by a qualified, licensed professional (electrician) only, and in compliance with the National Electric Code, local, and all other building and electrical codes. Worldwide Lighting's limited 1-yr. warranty is voided, and the firm is not responsible for damages or other issues, if appliance is installed by unlicensed parties
- 2) Lighting fixture is rated for 110 - 130v /60Hz. Bulbs are E12 (candelabra) base, 25 watt maximum. **IMPORTANT:** Note that on installation, fixture must be grounded.
- 3) Please keep lighting away from acids, alkali and other corrosive chemicals, gas and cleaning solutions. Clean only with a clean, soft cloth.
- 4) Never install lighting on a damp ceiling or surface. The room should be dry and well ventilated.
- 5) **IMPORTANT.** Precautions must be taken to support the fixture's full weight, independent of the ceiling-mounted junction box (typically rated for only 25 lbs.). This may require steel cables or strapping, heavy-duty bolts and hardware, and a strong, secure mounting surface independent of roofs and false or suspended ceilings. A licensed, professional contractor is the most qualified to determine proper mounting, particularly with respect to individual site conditions.
- 6) Care should be taken to avoid damage to the surface of lighting components and wiring during assembly & installation. To avoid smudging and other issues, we recommend wearing rubber or cotton gloves throughout the assembly / installation process.

Frame Assembly Instructions

Installation:

Please read all instructions carefully. Before you proceed to install, make sure that the power supply is turned off and remains off until installation is complete. please note that each part has been assigned a number. please proceed in a numerical order.

1. Fix the crossbar (01) on junction box.
2. Make sure the positive and negative charges of wire and lamp body match correctly, screw the connect point with the junction cap.
3. Make sure the main wire is enough long and keep the rest wire in the 4" j-box.
4. Screw the lamp body(02) on Crossbar(01) With Crossbar Bracket
5. As the crystal pressing instruction, hang the crystal parts.

The end!