

OPERATION

⚠ WARNING

- To reduce the risk of fire, electric shock, or injury to persons, read the SAFETY INSTRUCTIONS before operating this appliance.

Using the Dryer

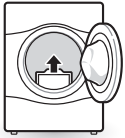

1 Clean the Lint Filter

If the lint filter has not already been cleaned, lift out the filter and remove the lint from the last load. This will help ensure the fastest and most efficient drying performance. Make sure to reinstall the filter, pressing down until it clicks firmly into place.

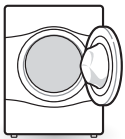

2 Load the Dryer

Load the dryer with the wet laundry from the washer. If the load is extra large, you may need to divide it into smaller loads for proper performance and fabric care.



3 Turn on the Dryer

Press the **Power** button to turn on the dryer. The cycle LEDs will illuminate and a chime will sound.



4 Select a Cycle

Turn the cycle selector knob either direction until the LED for the desired cycle is on. The preset temperature, dry level, and option settings for that cycle will be shown. Default settings for the selected cycle can now be changed if desired. Refer to the Cycle Setting and Options page for details.

NOTE

- Not all options or modifiers are available on all cycles. Refer to the Cycle Guide page for default settings and available options. A different chime will sound and the LED will not come on if the selection is not available.



5 Begin Cycle

Press the **Start/Pause** button to begin the cycle. The cycle can be paused at any time either by opening the door or by pressing the **Start/Pause** button. If the cycle is not restarted within 60 minutes of being paused, the dryer will shut off and the settings will be lost.



6 End of Cycle

When the cycle is finished, the chime will sound. Immediately remove your clothing from the dryer to reduce wrinkling. If Wrinkle Care is selected, the dryer will tumble briefly every few minutes to help prevent wrinkles from setting in the clothes.

Check the Lint Filter Before Every Load

Always make sure the lint filter is clean before starting a new load; a clogged lint filter will increase drying time. To clean, pull the lint filter straight up and roll any lint off the filter with your fingers. Push the lint filter firmly back into place. See **Regular Cleaning** for more information.



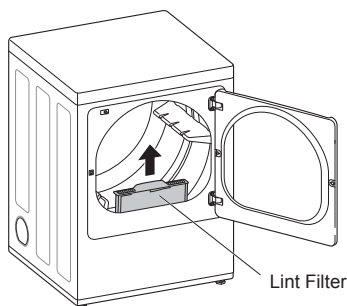







Always ensure the lint filter is properly installed before running the dryer. Running the dryer with a loose or missing lint filter will damage the dryer and articles in the dryer.



Sorting Laundry

Fabric Care Labels

Many articles of clothing include a fabric care label. Using the chart below, adjust the cycle and option selections to care for your clothing according to the manufacturer's recommendations.

Tumble dry			
	Dry		Gentle/delicate
	Normal		Do not tumble dry
	Permanent Press/ wrinkle resistant		Do not dry (used with do not wash)
Heat setting			
	High		Low
	Medium		No heat/air

Grouping Similar Items

For best results, sort clothes into loads that can be dried with the same drying cycle.

Different fabrics have different care requirements, and some fabrics will dry more quickly than others.

Loading the Dryer

WARNING

To reduce the risk of fire, explosion, electric shock, injury to persons, and death when using this appliance, follow basic precautions, including the following:

- Check all pockets to make sure that they are empty. Items such as clips, pens, coins, and keys can damage both the dryer and your clothes. Flammable objects such as lighters or matches could ignite, causing a fire.
- Never dry clothes that have been exposed to oil, gasoline, or other flammable substances. Washing clothes will not completely remove oil residues.

NOTE

Loading Tips

- Combine large and small items in the same load.
- Damp clothes will expand as they dry. Do not overload the dryer; clothes require room to tumble and dry properly.
- Close zippers, hooks, and drawstrings to prevent these items from snagging or tangling on other clothes.

Control Panel

Non-Steam Models (DLE3500*, DLG3501*)

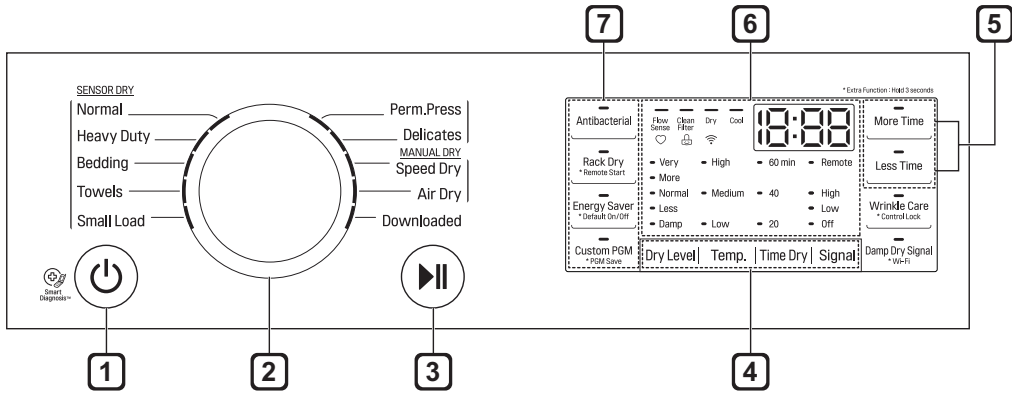

Steam Models (DLEX3700*, DLGX3701*)

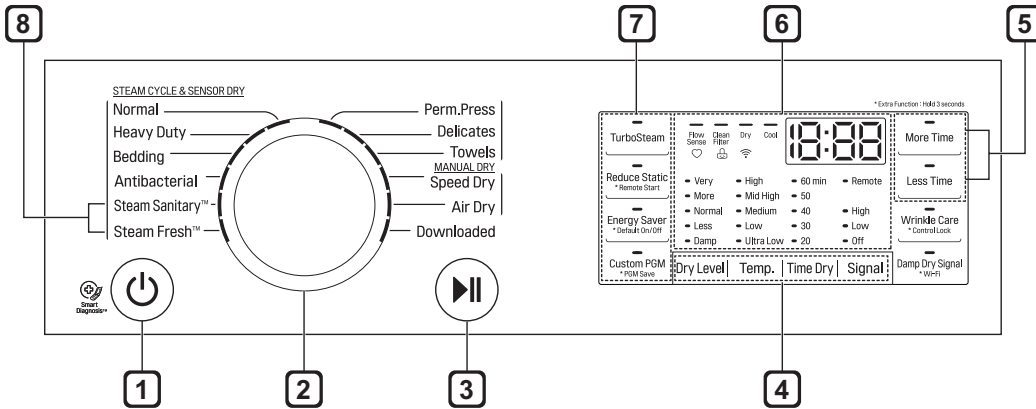

Steam Models (DLEX3900*, DLGX3901*)

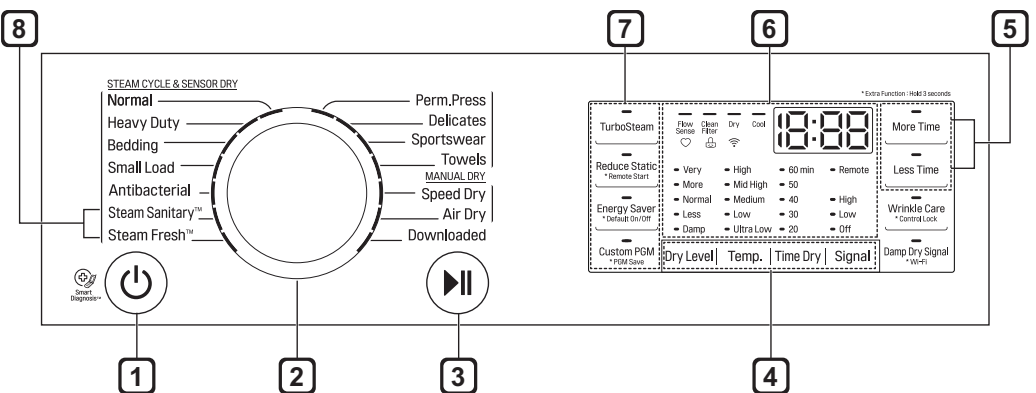

NOTE

- Model numbers can be found on the cabinet inside the door.

1 Power Button

Press the button to turn the dryer ON. Press again to turn the dryer OFF.

NOTE

- Pressing the **Power** button during a cycle will cancel that cycle and any load settings will be lost.

2 Cycle Selector Knob

Turn this knob to select the desired cycle. Once the desired cycle has been selected, the standard presets will be shown in the display. On Manual Dry cycles, these settings can be adjusted using the cycle modifier buttons anytime before starting the cycle.

3 Start/Pause Button

Press this button to start the selected cycle. If the dryer is running, use this button to pause the cycle without losing the current settings.

NOTE

- If you do not press the **Start/Pause** button to resume a cycle within 60 minutes, the dryer turns off automatically and all cycle settings are lost.

4 Cycle Modifier Buttons

Use these buttons to select the desired cycle settings for the selected cycle. The current settings are shown in the display. Press the button for that option to view and select other settings.

5 More Time/Less Time Buttons

Use these buttons with the Time Dry and other Manual Dry cycles to adjust the drying time. Press the **More Time** button to increase the selected manual cycle time by 1 minute; press the **Less Time** button to decrease the cycle time by 1 minute.

6 Time and Status Display

The display shows the settings, estimated time remaining, options, and status messages for the dryer.

7 Cycle Option Buttons

Press each of these buttons to select additional cycle options. And press and hold any button marked with an asterisk for 3 seconds to activate a special function.

8 Steam Functions

LG's steam technology allows you to inject fabrics with a swirling jet of steam to refresh clothes, reduce static, and make ironing easier. Simply select the **Steam Fresh™** or **Steam Sanitary™** cycle or you can add a Steam option to selected cycles.

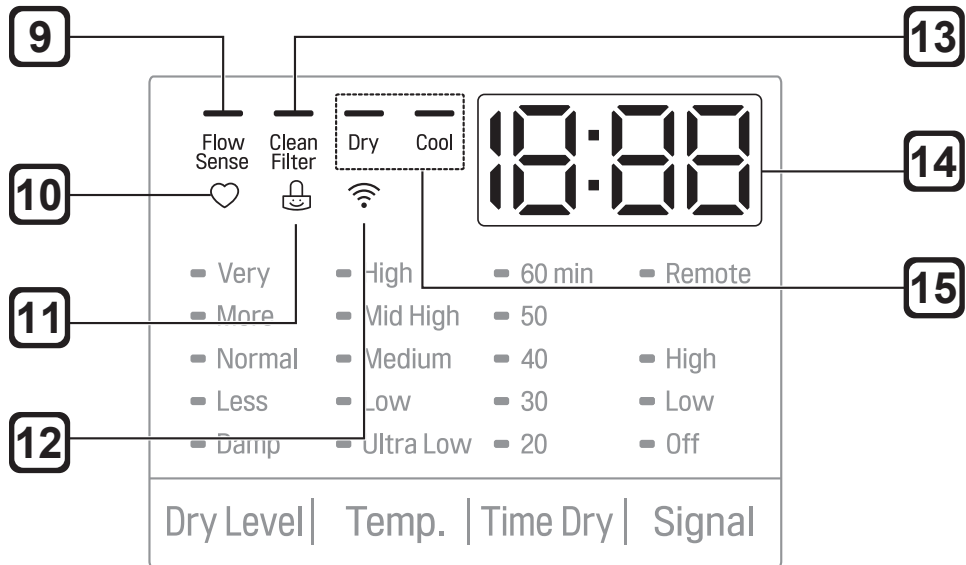

9 Flow Sense Duct Blockage Sensing System Indicator

The Flow Sense™ duct blockage sensing system detects and alerts you to blockages in the ductwork that reduce exhaust flow from the dryer. Maintaining a clean exhaust system improves operating efficiency and helps minimize service calls, saving you money.

10 Custom PGM

If you have a special combination of settings that you use frequently, you can save these settings as a Custom Program.

11 Control Lock Indicator

When Control Lock is set, the Control Lock indicator appears and all buttons are disabled except the **POWER** button. This prevents children from changing settings while the dryer is operating.

12 WI-FI Indicator

When the appliance is connected to the Internet through a home Wi-Fi network, this indicator appears.

13 Clean Filter Reminder

The display will show Clean Filter when the dryer is turned on as a reminder to clean the filter. It turns off when the **START/PAUSE** button is pressed.

14 Estimated Time Remaining

This display shows the estimated time remaining for Sensor Dry cycles or the actual time remaining for Time Dry or Manual Dry cycles.

NOTE

- The cycle time on Sensor Dry cycles may fluctuate as the dryer recalculates drying time for optimal results.

15 Cycle Completion Indicator

This portion of the display shows which stage of the drying cycle is currently underway (Dry or Cool).

Cycle Guide

Sensor Dry Cycles

Sensor Dry cycles utilize LG's unique dual sensor system to detect and compare the moisture level in clothes and in the air and adjust the drying time as needed to ensure superior results. The dryer automatically sets the dryness level and temperature at the recommended setting for each cycle. The estimated time remaining will be shown in the display.

NOTE

- To protect your garments not every dryness level, temperature, or option is available with every cycle. See the Cycle Guide for details.

Manual Dry Cycles

Use Manual Dry cycles to select a specific amount of drying time and a drying temperature. When a Manual Dry cycle is selected, the Estimated Time Remaining display shows the actual time remaining in your cycle. You can change the actual time in the cycle by pressing the **More Time** or **Less Time** buttons.

NOTE

- The Energy Saver option is turned on by default in the Normal Cycle. Turn off the Energy Saver option for a faster Normal cycle which begins with heated drying. To turn the Energy Saver default off, press and hold the **Energy Saver** button. ON or OFF appears in the display.

NSF Certification

NSF International (formerly the National Sanitation Foundation), certifies that the **Antibacterial** cycle reduces 99.9% of bacteria on laundry, and none of the bacteria will carry over onto the next laundry load.

- The default settings for the **Antibacterial** cycle are High temperature and Very dry level. These default settings cannot be changed.
- Do NOT use this cycle with delicate items or fabrics.



**Protocol P154 Sanitization
Performance of Residential
Clothes dryer**

(DLE3500*, DLG3501*, DLEX3700*, DLGX3701*,
DLEX3900*, DLGX3901*)

Non-Steam Models (DLE3500*, DLG3501*)

 = default setting

 = allowable option

* = Energy Saver on by default

Cycle	Fabric Type	Dry Level	Temp.	Wrinkle Care	Damp Dry Signal	Anti Bacterial
SENSOR DRY						
Normal*	Work clothes, corduroys, etc.	Normal	Medium	●	●	●
		Adj.				
Heavy Duty	Jeans, heavyweight items	Normal	High	●	●	●
		Adj.				
Bedding	Comforters, Pillows, Shirts	Normal	Medium			
		Adj.				
Towels	Denims, towels, heavy cottons	Normal	Medium	●	●	●
		Adj.				
Small Load	Only normal & cotton/towels fabric type (Max. 3lb)	Normal	High	●		
		Adj.				
Perm. Press	Permanent press, synthetic items	Normal	Medium	●	●	
		Adj.				
Delicates	Lingerie, sheets, blouses	Normal	Low	●	●	
		Adj.				
MANUAL DRY						
Speed Dry	For small loads with short drying times	Off	High	●		
			Adj.			
Air Dry	For items that require heat-free drying such as plastics or rubber	Off	No Heat	●		

Steam Models (DLEX3700*, DLGX3701*)

■ = default setting

● = allowable option

* = Energy Saver on by default

Cycle	Fabric Type	Dry Level	Temp.	Wrinkle Care	Damp Dry Signal	Reduce Static
SENSOR DRY						
Normal*	Work clothes, corduroys, etc.	Normal	Mid High	●	●	●
		Adj.				
Heavy Duty	Jeans, heavyweight items	Normal	High	●	●	●
		Adj.				
Bedding	Comforters, pillows, shirts	Normal	Medium			●
		Adj.				
Anti Bacterial	Do not use this cycle with delicate fabrics	Very	High	●		
Perm. Press	Permanent press, synthetic items	Normal	Medium	●	●	●
		Adj.				
Delicates	Lingerie, sheets, blouses	Normal	Low	●	●	●
		Adj.				
Towels	Denims, towels, heavy cottons	Normal	Mid High	●	●	●
		Adj.				
MANUAL DRY						
Speed Dry	For small loads with short drying times	Off	High	●		●
			Adj.			
Air Dry	For items that require heat-free drying such as plastics or rubber	Off	No Heat	●		
STEAM CYCLE						
Steam Sanitary™	Comforter, bedding, children's clothing	Off	High	●		
Steam Fresh™	Comforter, shirts, trousers (except especially delicate fabrics)	Off	Mid High	●		
			Adj.			

Steam Models (DLEX3900*, DLGX3901*)

☐ = default setting

● = allowable option

* = Energy Saver on by default

Cycle	Fabric Type	Dry Level	Temp.	Wrinkle Care	Damp Dry Signal	Reduce Static
SENSOR DRY						
Normal*	Work clothes, corduroys, etc.	Normal	Mid High	●	●	●
		Adj.				
Heavy Duty	Jeans, heavyweight items	Normal	High	●	●	●
		Adj.				
Bedding	Comforters, pillows, shirts	Normal	Medium			●
		Adj.				
Small Load	Only normal & cotton/towels fabric type (Max. 3lb)	Normal	High	●		
		Adj.				
Anti Bacterial	Do not use this cycle with delicate fabrics	Very	High	●		
Perm. Press	Permanent press, synthetic items	Normal	Medium	●	●	●
		Adj.				
Delicates	Lingerie, sheets, blouses	Normal	Low	●	●	●
		Adj.				
Sportswear	Sports Wear	Off		●		●
Towels	Denims, towels, heavy cottons	Normal	Mid High	●	●	●
		Adj.				
MANUAL DRY						
Speed Dry	For small loads with short drying times	Off	High	●		●
			Adj.			
Air Dry	For items that require heat-free drying such as plastics or rubber	Off	No Heat	●		
STEAM CYCLE						
Steam Sanitary™	Comforter, bedding, children's clothing	Off	High	●		
Steam Fresh™	Comforter, shirts, trousers (except especially delicate fabrics)	Off	Mid High	●		
			Adj.			

Cycle Modifier Buttons

Sensor Dry cycles have preset settings that are selected automatically. Manual Dry cycles have default settings, but you may also customize the settings using the cycle modifier buttons. Press the button for that option to view and select other settings.

Dry Level

Use this button to select the level of dryness for the cycle. Press the **Dry Level** button repeatedly to scroll through available settings.

- This option is only available with Sensor Dry cycles.
- The dryer will automatically adjust the cycle time. Selecting More or Very will increase the cycle time, while Less or Damp will decrease the cycle time.
- Use a Less or Damp setting for items that you wish to iron.

Temp.

Use this button to adjust the temperature setting. This allows precise care of fabrics and garments. Press the **Temp.** button repeatedly to scroll through available settings.

Time Dry

Use this button to manually select the drying time, from 20 to 60 minutes, in 10-minute increments. Use this for small loads or to remove wrinkles. Use the **More Time/Less Time** buttons to add or reduce the drying time in 1-minute increments.

Signal

Use this button to adjust the volume of the end of cycle signal or turn off the signal. Press the button repeatedly until the desired volume setting is illuminated.

Option Buttons

The dryer features several additional cycle options to customize cycles to meet individual needs. Certain option buttons also feature a special function that can be activated by pressing and holding that option button for 3 seconds.

Adding Cycle Options to a Cycle

- 1 Turn on the dryer and turn the Cycle selector knob to select the desired cycle.
- 2 Use the cycle modifier buttons to adjust the settings for that cycle.
- 3 Press the cycle option button(s) to add the desired options. A confirmation message is shown in the display.
- 4 Press the **Start/Pause** button to start the cycle. The dryer starts automatically.

Wrinkle Care

Selecting this option will tumble the load periodically for up to 3 hours after the selected cycle, or until the door is opened. This is helpful in preventing wrinkles when you are unable to remove items from the dryer immediately.

Damp Dry Signal

When this option is selected, the dryer signals when the load is approximately 80% dry. This allows you to remove faster-drying lightweight items or items that you would like to iron or hang while they are still slightly damp.

Energy Saver

This option helps to reduce the energy consumption of the Normal Cycle, depending on the load size. When the Energy Saver option is selected, the cycle begins with an air dry section and the drying time is increased.

Rack Dry (On Some Models)

Use the Rack Dry function with items, such as wool sweaters, silk items, and lingerie, that should be dried flat. Rack Dry can also be used with items that should not be tumbled dry, such as gym shoes or stuffed animals.

NOTE

- NEVER tumble dry a load of clothing with the rack installed.
- When the rack is installed, the drum will rotate as usual, but the rack will not move. Make sure all articles to be dried remain completely on the rack and cannot fall off or be pulled off by the turning drum. Be sure to remove the rack after use.

Using the Rack Dry Cycle

- 1 With the dryer door open, slide the rack into the dryer drum.

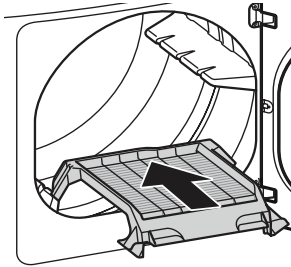

- 2 Make sure it is seated evenly on the edge of the inner door rim and resting flat on the inside of the dryer.

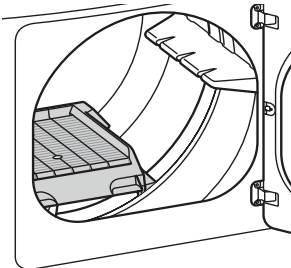

- 3 Place wet items on the rack. Allow space around the items for air to circulate.
- 4 Close the door and select **Rack Dry**.
- 5 Press **Temp.** to select a temperature option. If no temperature is selected, Rack Dry defaults to no heat.

Special Functions

Some cycle option buttons also activate secondary functions. These special functions are marked with an asterisk (*). Press and hold the option button marked with the special function to activate it.

Control Lock

Use this option to prevent unwanted use of the dryer or to keep cycle settings from being changed while the dryer is operating.

Activating the Control Lock Function

Press and hold the Wrinkle Care button for 3 seconds.

The Control Lock icon will be shown in the display, and all controls will be disabled except the Power button.

Deactivating the Control Lock Function

Press and hold the Wrinkle Care button for 3 seconds.

Once set, Control Lock remains active until it is manually deactivated. Control Lock must be turned off to run another cycle.

Custom PGM

Save special combinations of settings that are used frequently as a custom program.

Saving a Custom Program

- 1 Turn on the dryer and select the desired settings using the cycle selector knob and cycle modifier or option buttons.
- 2 Press and hold the **Custom PGM** button for three seconds.

NOTE

- Only one custom program can be saved at a time. Pressing and holding the **Custom PGM** button will overwrite any previously saved custom program.

Recalling a Custom Program

- 1 Turn on the dryer and press the **Custom PGM** button.
- 2 Press the **Start/Pause** button to start the cycle.

Default On/Off

This option allows the Energy Saver settings to be changed. To run a Normal cycle without the Energy Saver option, press and hold the **Energy Saver** button for three seconds. ON or OFF appears in the display.

Steam Functions (Steam Models)

LG's new steam technology injects fabrics with a swirling jet of hot steam to refresh clothes, reduce static, and make ironing easier.

Simply select the Steam Fresh™ cycle, or add a steam option to selected cycles.

WARNING

To reduce the risk of serious injury, death, explosion, or fire, follow basic safety precautions, including the following:

- Do not open the dryer door during steam cycles.
- Do not touch the steam nozzle in the drum during or after the steam cycle.

The Steam Sanitary™ Cycle

The Steam Sanitary™ cycle is ideal for sanitizing non-washable items quickly and easily using the power of steam.

Use this cycle for cotton and polyester material. (Do NOT use for urethane foam, down feathers or delicate items).

The Steam Fresh™ Cycle

Steam Fresh™ uses the power of steam to quickly reduce wrinkles and odors in fabrics. It brings new life to wrinkled clothes that have been stored for an extended time and makes heavily wrinkled clothes easier to iron. Steam Fresh™ can also be used to help reduce odors in fabrics.

NOTE

- Reduce Static options can also be used during the Steam Fresh™ cycle.
- The cycle time depends on the load (number of items). Press the **More Time** or **Less Time** button to change the display to reflect the number of items in the load. The display will show 3, 5, or *b' 9*. 3 means 3 or fewer items, 5 is for 4 or 5 items, and *b' 9* indicates a large load such as a comforter.

Using the Steam Fresh™ Cycle

- 1 Turn on the dryer and turn the cycle selector knob to select the **Steam Fresh™** cycle.
- 2 To add an option function, select **Reduce Static**, or **Wrinkle Care**.
- 3 The display shows the load size (number of items). Change the steam time by pressing the **More Time** or **Less Time** buttons to fit the size of the load.
- 4 Press **Start/Pause** to start the cycle.

The Steam Options

The Reduce Static option injects steam late in the drying cycle to reduce the static electricity caused by dry fabrics rubbing together.

NOTE

- When Sensor Dry is selected with the Reduce Static option, a Dry level of Less or Damp cannot be selected.
- The Reduce Static option can also be selected during Time Dry cycles.
- After the Steam option is selected in Time Dry, the **More Time** or **Less Time** buttons will change the steam time ONLY.
- Depending on the load (quantity of items), you can change the amount of time for the cycle by pressing the **More Time** or **Less Time** button. (Reduce static: 7, 9, 11, 14, 16, or 18)

Adding Steam to a Standard Cycle

- 1 Turn on the dryer and turn the cycle selector knob to select the desired cycle.
- 2 Use the cycle setting buttons to adjust the settings for that cycle.
- 3 Press the Steam option button (Reduce Static, or Wrinkle Care) for the desired steam option. Then adjust for the load size using the **More Time** or **Less Time** buttons.
- 4 Press **Start/Pause** to start the cycle.

NOTE

- Steam may not be clearly visible during the steam cycles. This is normal.
- Do not use Steam Fresh™ with items such as wool, wool blankets, leather jackets, silk, wet clothes, lingerie, foam products, or electric blankets.
- For best results, load articles of similar size and fabric type. Do not overload.
- When the filter/duct is clogged, the steam option may not have optimal results.
- When the steam function is operating, the drum will stop to allow steam to stay in the drum.
- The steam feeder must be filled with water up to the filter screen. Otherwise, an error message will be displayed.

Steam Cycle Guide

= default setting

● = allowable option

	Steam	Default Time	Temp.	Dry Level	Fabric State	Fabric Type	Maximum Amount
Steam Sanitary™	Turbo Steam	31 minutes			Dry	Comforter Bedding	Single (1 each)
						Children's clothing	3 lbs.
Steam Fresh™	Turbo Steam	10 minutes	●		Dry	Comforter	Single (1 each)
						Shirts*	5 each
Steam Option	Reduce Static	Follows Selected Cycle		●	Wet	Varies by selected cycle	8 lbs. (18 Items.)
	Turbo Steam	Follows Selected Cycle		●	Wet	Varies by selected cycle	8 lbs. (18 Items.)
Time Dry	Reduce Static	38 minutes	●		Wet	Varies by selected cycle	8 lbs. (18 Items.)



* Shirt: 70% cotton, 30% poly blend. Except especially delicate fabrics

SMART FUNCTIONS

LG SmartThinQ Application

The LG SmartThinQ application allows you to communicate with the appliance using a smartphone.

Before Using LG SmartThinQ

- For appliances with the  or  logo

- 1 Use a smartphone to check the strength of the wireless router (Wi-Fi network) near the appliance.
 - If the distance between the appliance and the wireless router is too far, the signal strength becomes weak. It may take a long time to register or installation may fail.
- 2 Turn off the **Mobile data** or **Cellular Data** on your smartphone.

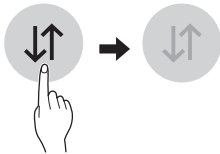

- 3 Connect your smartphone to the wireless router.

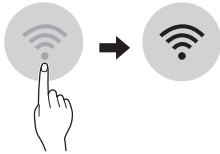

NOTE



- To verify the Wi-Fi connection, check that **Wi-Fi**  icon on the control panel is lit.
- The appliance supports 2.4 GHz Wi-Fi networks only. To check your network frequency, contact your Internet service provider or refer to your wireless router manual.
- LG SmartThinQ is not responsible for any network connection problems or any faults, malfunctions, or errors caused by network connection.
- The surrounding wireless environment can make the wireless network service run slowly.

- If the appliance is having trouble connecting to the Wi-Fi network, it may be too far from the router. Purchase a Wi-Fi repeater (range extender) to improve the Wi-Fi signal strength.
- The network connection may not work properly depending on the Internet service provider.
- The Wi-Fi connection may not connect or may be interrupted because of the home network environment.
- If the appliance cannot be registered due to problems with the wireless signal transmission, unplug the appliance and wait about a minute before trying again.
- If the firewall on your wireless router is enabled, disable the firewall or add an exception to it.
- The wireless network name (SSID) should be a combination of English letters and numbers. (Do not use special characters.)
- Smartphone user interface (UI) may vary depending on the mobile operating system (OS) and the manufacturer.
- If the security protocol of the router is set to **WEP**, network setup may fail. Change the security protocol (**WPA2** is recommended), and register the product again.

Installing the LG SmartThinQ Application

Search for the LG SmartThinQ application from the Google Play Store or Apple App Store on a smart phone. Follow instructions to download and install the application.

LG SmartThinQ Application Features

- For appliances with the  or  logo

Dryer Cycle

Download new and specialized cycles that are not included in the standard cycles on the appliance.

Appliances that have been successfully registered can download a variety of specialty cycles specific to the appliance.

Only one cycle can be stored on the appliance at a time.

Once cycle download is completed in the appliance, the appliance keeps the downloaded cycle until a new cycle is downloaded.

Venting Tips

Provides venting tips.

Smart Diagnosis™

This function provides useful information for diagnosing and solving issues with the appliance based on the pattern of use.

Energy Monitoring

The dryer energy usage is affected by the cycles and options so you may see some changes in energy usage from one cycle to another.

Push Alerts

When the cycle is complete or the appliance has problems, you have the option of receiving push notifications on a smart phone.

Settings

Set the product nickname and delete product.

NOTE

- To verify the Wi-Fi connection, check that **Wi-Fi**  icon on the control panel is lit.
- LG Smart ThinQ is not responsible for any network connection problems or any faults, malfunctions, or errors caused by network connection.
- The machine supports 2.4 GHz Wi-Fi networks only.
- If the appliance is having trouble connecting to the Wi-Fi network, it may be too far from the router. Purchase a Wi-Fi repeater (range extender) to improve the Wi-Fi signal strength.
- The Wi-Fi connection may not connect or may be interrupted because of the home network environment.
- The network connection may not work properly depending on the internet service provider.
- The surrounding wireless environment can make the wireless network service run slowly.
- This information is current at the time of publication. The application is subject to change for product improvement purposes without notice to users.

Using Remote Start

Use a smart phone to control the appliance remotely or check to see how much time is left in the cycle.

- 1 Press the **Power** button.
- 2 Load the laundry.
- 3 Press and hold the **Remote Start** button for 3 seconds to enable the Remote Start function.
- 4 Start a cycle from the LG Smart ThinQ application on your smart phone.

NOTE

- Once the Remote Start mode is enabled, you can start a cycle from the LG Smart ThinQ smartphone application. If the cycle is not started, the machine will wait to start the cycle until it is turned off remotely from the application or the Remote Start mode is disabled.
- If the door is opened, Remote Start is disabled.

Disabling Remote Start

When the Remote Start is activated, press and hold the **Remote Start** button for 3 seconds.

Wireless LAN Module Specifications

Model	LCW-004
Frequency Range	2412 to 2462 MHz
Output Power (Max)	IEEE 802.11 b: 22.44 dBm
	IEEE 802.11 g: 24.68 dBm
	IEEE 802.11 n: 24.11 dBm

FCC Notice

This equipment has been tested and found to comply with the limits for a Class B digital device, pursuant to Part 15 of the FCC Rules. These limits are designed to provide reasonable protection against harmful interference in a residential installation. This equipment generates, uses, and can radiate radio frequency energy and, if not installed and used in accordance with the instructions, may cause harmful interference to radio communications. However, there is no guarantee that interference will not occur in a particular installation. If this equipment does cause harmful interference to radio or television reception, which can be determined by turning the equipment off and on, the user is encouraged to try to correct the interference by one or more of the following measures:

- Reorient or relocate the receiving antenna.
- Increase the separation between the equipment and the receiver.
- Connect the equipment to an outlet on a circuit different from that to which the receiver is connected.
- Consult the dealer or an experienced radio/TV technician for help.

This device complies with part 15 of the FCC Rules. Operation is subject to the following two conditions:

- 1) this device may not cause harmful interference and
- 2) this device must accept any interference received, including interference that may cause undesired operation of the device.

Any changes or modifications in construction of this device which are not expressly approved by the party responsible for compliance could void the user's authority to operate the equipment.

FCC RF Radiation Exposure Statement

This equipment complies with FCC radiation exposure limits set forth for an uncontrolled environment. This transmitter must not be co-located or operating in conjunction with any other antenna or transmitter.

This equipment should be installed and operated with a minimum distance of 20 cm (7.8 inches) between the antenna and your body. Users must follow the specific operating instructions for satisfying RF exposure compliance.

Open Source Software Notice Information



To obtain the source code under GPL, LGPL, MPL, and other open source licenses, that is contained in this product, please visit <http://opensource.lge.com>. In addition to the source code, all referred license terms, warranty disclaimers and copyright notices are available for download.

LG Electronics will also provide open source code to you on CD-ROM for a charge covering the cost of performing such distribution (such as the cost of media, shipping, and handling) upon email request to opensource@lge.com. This offer is valid for three (3) years from the date on which you purchased the product.

Smart Diagnosis™ Function

Should you experience any problems with the appliance, it has the capability of transmitting data via your telephone to the LG Customer Information Center. NFC or Wi-Fi equipped models can also transmit data to a smartphone using the LG SmartThinQ application.

Smart Diagnosis™ through the Customer Information Center

- For appliances with the  or  logo



This method allows you to speak directly to our trained specialists. The specialist records the data transmitted from the appliance and uses it to analyze the issue, providing a fast and effective diagnosis.

- 1 Call the LG Electronics Customer Information Center at:
(LG U.S.A.) 1-800-243-0000
(LG Canada) 1-888-542-2623
- 2 When instructed to do so by the call center, place the mouthpiece of the phone close to the Smart Diagnosis™ icon. Do not press any other buttons.
- 3 Press and hold the **Temp.** button for 3 seconds.
- 4 Keep the phone in place until the tone transmission has finished.
- 5 Once the countdown is over and the tones have stopped, resume your conversation with the call center agent, who will then be able to assist you using the information transmitted for analysis.

NOTE

- Smart Diagnosis™ cannot be activated unless the appliance can be turned on using the **Power** button. If the appliance cannot be turned on, troubleshooting must be done without using Smart Diagnosis™.
- For best results, do not move the phone while the tones are being transmitted.
- If the call center agent is not able to get an accurate recording of the data, you may be asked to try again.
- The Smart Diagnosis™ function depends on the local call quality.
- Bad call quality may result in poor data transmission from your phone to the call center, which could cause Smart Diagnosis™ to malfunction.

SmartThinQ Smart Diagnosis™

- For appliances with the  or  logo

Use the Smart Diagnosis feature in the SmartThinQ application for help diagnosing issues with the appliance without the assistance of the LG Customer Information Center.

Follow the instructions in the SmartThinQ application to perform a Smart Diagnosis using your smartphone.

NOTE

- Smart Diagnosis™ cannot be activated unless the appliance can be turned on using the **Power** button. If the appliance cannot be turned on, troubleshooting must be done without using Smart Diagnosis™.

MAINTENANCE

Regular Cleaning

WARNING

To reduce the risk of fire, electric shock, injury to persons, or death when using this appliance, follow basic precautions, including the following:

- Unplug the dryer before cleaning.
- Never use harsh chemicals, abrasive cleaners, or solvents to clean the washer. They will damage the finish.

Cleaning the Exterior

Proper care of your dryer can extend its life. The outside of the machine can be cleaned with warm water and a mild, nonabrasive household detergent. Immediately wipe off any spills with a soft, damp cloth.

NOTE

- Do not use methylated spirits, solvents, or similar products.
- Never use steel wool or abrasive cleansers; they can damage the surface.

Cleaning the Interior

Wipe around the door opening and seal with a soft, damp cloth to prevent lint and dust buildup that could damage the door seal.

Clean the window with a soft cloth dampened with warm water and a mild, nonabrasive household detergent, then wipe dry.

The stainless steel drum can be cleaned with a conventional stainless steel cleaner, used according to the manufacturer's specifications. Never use steel wool or abrasive cleansers; they may scratch or damage the surface.

Cleaning Around and Under the Dryer

Vacuum lint and dust from around the dryer and underneath it regularly. Vent ductwork should be checked for lint buildup and cleaned at least once per year. If any noticeable reduction in airflow or drying performance occurs, immediately check ductwork for obstructions and blockages.

Maintaining Ductwork

Vent ductwork should be checked for lint buildup once per month and cleaned at least once per year. If any noticeable reduction in airflow or drying performance occurs, immediately check ductwork for obstructions and blockages. Contact a qualified technician or service provider.

Cleaning the Lint Filter

Always clean the lint from the filter after every cycle.

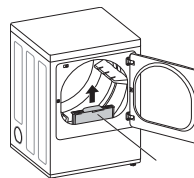

Lint Filter

To clean the lint filter, open the dryer door and pull the lint filter straight up. Then:

- 1 For everyday cleaning, roll any lint off the filter with your fingers, or

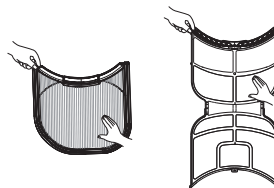

- 2 Vacuum the lint filter.

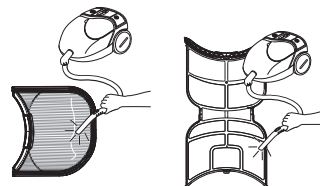

- 3 If the lint filter has become very dirty or clogged with fabric softener, wash the lint filter in warm, soapy water and allow it to dry thoroughly before reinstalling.

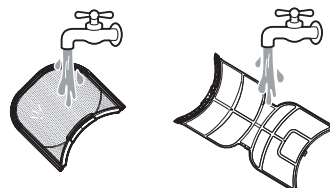

NOTE

- NEVER operate the dryer without the lint filter in place.