



THE HOME DEPOT

Inspection Requirement

2455 PACES FERRY ROAD
ATLANTA, GEORGIA 30339-4024

REPORT NO.: 85122610718V05

SKU #:	See table 1	MODEL #:	See table 1	DEPT. #:	59	COE #:	5
SUPPLIER:	YERSH			SUPPLIER #:	12325		
FACTORY:	XIAMEN UPTRADE FURNISHING INDUSTRIAL CO., LTD.			FACTORY #:	2004423		
FACTORY ADDRESS:	NO.5-11, HUATAI ROAD, HULI DISTRICT, XIAMEN FUJIAN, CHINA						
PRODUCT DESCRIPTION:	See table 1						

Refer to part 4 (Product photo)

IMPORTANT: The product photos are not intended as the color reference.

This product requirement contains the following documents:

1. Product Requirements
2. Packaging Requirements
3. Product Documentation
4. Product Photos
5. Inspection Plan
6. Defect classification
7. Revision history

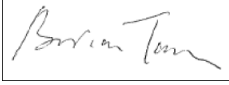
	Prepared by:	Sally Fan	Reviewed by:	Nancy Du	Approved by:	 (Brian Tam)
	Date:	Dec 21, 2012	Date:	Dec 21, 2012	Date:	Dec 21, 2012
	Control-Subcontrol Number:			See table 1		

1. Product Requirements

1.1 GENERAL REQUIREMENT						
Item#	Item	Qty	Style / Feature / Finish / Color	Dimension / Measurement	Tolerance	Material
See table 1	See table 1	1	WHITE, OAK, BROWN, MAHOGANY	See table 1	For dimension: +/-5%; For weight: +/-10%	Metal, Wood, Plastic
1.2 PRE-PURCHASE TESTING RESULT						
This product must achieve a rating of “Good” under The Home Depot’s Pre-Purchase Testing Program or “unsatisfactory” but with THD’S PPT Waiver.		PPT REPORT NO: 85122610718 85131490352		RATING: Good; Good with waiver	REMARK: BST was waived by client.	
1.3 PERFORMANCE TESTS						
Test Property	Test Requirement			Comments		
Full assembly Check (For complex product requires long time assembly.)	The product should be assembled successfully according to instruction sheet; also the product should function properly and safely after assembly.			Nil		
Load capacity	Shall Withstand distribute load at the following requirement. For 1 hours without permanent damage. Rods up to 48 in: 15 lb Rods over 48 in: load with ¼ lb per inch of length. (Distribute the load across 50% of the rod length applied in the middle of the rod while loaded)			Nil		
Moisture Content Test of natural wood material only	The moisture content of wood product intended for indoor use shall be within 4%-13%; The moisture content of wood product intended for outdoor use shall be within 8% - 12%;			Nil		
Coating Adhesion Test on Coating / Painting Component (if available)	<p>1. Cross Hatching Test: Coated metal items shall be rated per the scale specified in the standard when tested as appropriate. Cut coating as specified, apply tape to cuts, then remove tape after 2 min and examine for removal of coating from substrate. Photograph if any plating / finish is removed. Select cutting method as follows: Use the cutter to make parallel cut so that space the cuts 2mm apart and make six cuts: 6 lines (columns) x 6 lines (row) lead to 2mm x 2mm x 25 grids.</p> <p>2. Tape Test: Coated nonmetallic component: press the adhesive tape on coating / painting surface apply tape to cuts, remove tape after 2 min and examine for removal of coating from substrate.</p>			Nil		

Table 1

SKU#	Model#	Index#	Product description	Dimension (in, LxWxH)	Weight (lbs)
606838/USA	33-WP-61	7656.3442.4107.51662	MSL 1PC 6ft 1-3/8" Reeded pole Wh	1.3x1.3x72.0	1.54
607061/USA	33-WP-62	7656.3442.4107.51663	MSL 1PC 6ft 1-3/8" Reeded pole Oak	1.3x1.3x72.0	1.54
607070/USA	33-WP-64	7656.3442.4107.51673	MSL 1PC 6ft 1-3/8" Reeded pole Mah	1.3x1.3x72.0	1.54
607110/USA	33-WP-81	7656.3442.4107.51674	MSL 1PC 8ft 1-3/8" Reeded pole Wh	1.3x1.3x96.0	1.96
608086/USA	33-WP-82	7656.3442.4107.51675	MSL 1PC 8ft 1-3/8" Reeded pole Oak	1.3x1.3x96.0	1.96
608763/USA	33-WP-84	7656.3442.4107.51677	MSL 1PC 8ft 1-3/8" Reeded pole Mah	1.3x1.3x96.0	1.96
609722/USA	33-WP-85	7656.3442.4107.51678	MSL 1PC 8ft 1-3/8" Smooth pole Wh	1.3x1.3x96.0	2.31
725796/USA	46-WP-83	8034.3442.4107.51761	MSL 1PC 8ft 1-13/16" Reeded pole Mah	1.81x1.81x96.0	3.84
744891/USA	46-DT-83	9574.3442.4107.51763	MSL 1PC 8FT 1-13/16" TRAVERSE ROD SET MAH	96x1.5x2.5	4.26

----- End of This Section -----

2. Packaging Requirements

Label Location	Refer to Section 3
Sensormatic Tags	Reference code 1.4.3.1 & 1.4.3.2 in BV IR 600000
UPC/UCC on unit package I 2 of 5 number on master carton (if available)	Reference code 1.4.1.6 & 1.4.1.10 in BV IR 600000, the number should is:
	UPC/UCC number: See table 2
	I 2 of 5 number: See table 2
Country of Origin	Reference code 1.4.1.2 in IR 600000
	Country of Origin: CHINA
Importer name and address	Reference code 1.4.1.5 in IR 600000
	Importer name and address: Refer to IR 600000 --- USA
Bilingual requirement for caution and warning statements and any inserts or instruction manual	Reference code 1.4.1.7 in IR 600000
Safety listing Label	Reference code 1.4.1.6 in IR 600000 or Refer to section 3.1
Instruction Sheet	Clear assembly / operating instructions (as applicable) should be identical to those shown in Sec 3
Warranty Card	N/A
Unit package	Reference code 1.4.in IR 600000
Unit package Size	(L) x (W) x (H)(in): 33-WP-61 & 33-WP-62 & 33-WP-64: 1.30x1.30x72.0 33-WP-81 & 33-WP-82 & 33-WP-84 & 33-WP-85: 1.30x1.30x96.0 46-WP-83: 1.81x1.81x96.0; 46-DT-83: 2.95"x2.95"x96.85"
Method	For 46-DT-83: 1 set was packed into brown box with color label, and 2 browon boxes were packed into 1 master shipping carton.
	For other items: 2pcs per master carton
SWPM (Solid wooden packing material) is used for product packing	No

For 46-DT-83:







No photo

For other items



Packaging Specification			
SKU No.	606838 / 607061 / 607070/607110/ 608086/608763/ 609722/725796	Model No.	33-WP-61 / 33-WP-62 / 33-WP-64 / 33-WP-81 / 33-WP-82 / 33-WP-84 / 33-WP-85 / 46-WP-83
Piece count	1	Case count	2
Package component description:	Master Carton Single-Wall corrugated	Unit Packaging	
Component Material:	Corrugated	Shrink Wrap	
Packaging component per SKU	1/2	/	
Component dimension: (in, L x W x D)	33-WP-61/33-WP-62/33-WP-64: 3.15 x 73.03 x 1.65 33-WP-81/33-WP-82/33-WP-84: 3.15 x 97.05 x 1.65 46-WP-83: 4.21x97.05x2.17	33-WP-61/33-WP-62/33-WP-64: 1.3 x 1.3 x 72 33-WP-81/33-WP-82/33-WP-84: 1.3 x 1.3 x 96 46-WP-83: 1.81x1.81x96	
Outer Shipping Case (Tick one per SKU)	<input checked="" type="checkbox"/> X]	<input type="checkbox"/>]	<input type="checkbox"/>]
Outbound Load Configuration: (select one)	[<input checked="" type="checkbox"/> X] Floor stack [<input type="checkbox"/>] Pallet [<input type="checkbox"/>] Slip sheet [<input type="checkbox"/>] Crate [<input type="checkbox"/>] others, _____		
Gross weight of shipping carton: (lb, includes product)	3.91 for 33-WP-61/33-WP-62/33-WP-64 4.75 for 33-WP-81/33-WP-82/33-WP-84 5.70 for 33-WP-85 9.13 for 46-WP-83	Pallet or crate size: (inch, Length X Width, if applicable)	N/A

Packaging Specification			
SKU No.	744891/USA	Model No.	46-DT-83
Piece count	1	Case count	2
Package component description:	Single wall-corrugated master container	Large single wall-corrugated inner cartons	Small single wall-corrugated inner cartons
Component Material:	Corrugated	Corrugated	Corrugated
Packaging component per SKU	1/2	1/1	1/1
Component dimension: (in, L x W x D)	97-1/2"x6-1/2"x3-7/8"	96-3/4"x2-7/8"x3"	9-3/4"x2-5/8"x1-3/8"
Outer Shipping Case (Tick one per SKU)	[X]	[]	[]
Outbound Load Configuration: (select one)	[X] Floor stack [] Pallet [] Slip sheet [] Crate [] others, _____		
Gross weight of shipping carton: (lb, includes product)	12.8 Lbs.	Pallet or crate size: (inch, Length X Width, if applicable)	N/A

Table 2

SKU#	Model#	UPC#	I2of5#
606838/USA	33-WP-61	4713105460001	14713105460008
607061/USA	33-WP-62	4713105460018	14713105460015
607070/USA	33-WP-64	4713105460032	14713105460039
607110/USA	33-WP-81	4713105460049	14713105460046
608086/USA	33-WP-82	4713105460056	14713105460053
608763/USA	33-WP-84	4713105460070	14713105460077
609722/USA	33-WP-85	4713105460087	14713105460084
725796/USA	46-WP-83	4713105460537	14713105460534
744891/USA	46-DT-83	4713105460544	14713105460541

NOTES:

- Other than the specific Packaging Requirement above, for General Packaging Requirement please refer to **IR600000**).
- For any changes of marking, printing, parts and /or components, the vendor should inform The Home Depot. The changes of parts or components may require re-submitting for evaluation.
- Any changes of marking, printing, parts and /or components without informing The Home Depot would be counted as a violation of this Product Requirement.

----- End of This Section -----

3. Product Documentation

3.1 (Manuals, instruction sheets, parts list, labels, artwork, etc.)

Artwork for SKU#606838

MARTHA STEWART LIVING™

1-3/8 IN REEDED POLE 6 FT
POSTE GRABADO DE 3,4 CM, 1,82 M

606 838

WHITE FINISH
 ACABADO EN BLANCO

DIAMETER: 1-3/8 IN
 DIÁMETRO: 3,4 CM
LENGTH: 6 FT
 LONGITUD: 1,82 M

FOR ASSISTANCE, CALL:
 SI NECESITA AYUDA, LLÁME AL:
 1-877-527-0313
 HOMEDEPOT.COM

MARSHA STEWART LIVING™ and the
 MARSHA STEWART Logo™ are trademarks of
 Martha Stewart Living Omnimedia, Inc.
 © Martha Stewart Living Omnimedia, Inc.
 All rights reserved.

Recycle Recicla

MADE IN CHINA
 HECHO EN CHINA

DISTRIBUIDO POR:
 HOME DEPOT
 2455 PACES FERRY RD., N.W.
 ATLANTA, GA 30339

4 713 105 460001

Artwork for SKU# 607061

MARTHA STEWART LIVING™

1-3/8 IN REEDED POLE 6 FT
POSTE GRABADO DE 3,4 CM, 1,82 M

607 061

HERITAGE OAK FINISH
 ACABADO EN ROBLE HERITAGE

DIAMETER: 1-3/8 IN
 DIÁMETRO: 3,4 CM
LENGTH: 6 FT
 LONGITUD: 1,82 M

FOR ASSISTANCE, CALL:
 SI NECESITA AYUDA, LLÁME AL:
 1-877-527-0313
 HOMEDEPOT.COM

MARSHA STEWART LIVING™ and the
 MARSHA STEWART Logo™ are trademarks of
 Martha Stewart Living Omnimedia, Inc.
 © Martha Stewart Living Omnimedia, Inc.
 All rights reserved.

Recycle Recicla

MADE IN CHINA
 HECHO EN CHINA

DISTRIBUIDO POR:
 HOME DEPOT
 2455 PACES FERRY RD., N.W.
 ATLANTA, GA 30339

4 713 105 460018

Artwork for SKU# 607070

MARTHA STEWART LIVING™

1-3/8 IN REEDED POLE 6 FT
POSTE GRABADO DE 3,4 CM, 1,82 M

607 070

ANTIQUE MAHOGANY FINISH
 ACABADO EN CAOBA ANTIGUO

DIAMETER: 1-3/8 IN
 DIÁMETRO: 3,4 CM
LENGTH: 6 FT
 LONGITUD: 1,82 M

FOR ASSISTANCE, CALL:
 SI NECESITA AYUDA, LLÁME AL:
 1-877-527-0313
 HOMEDEPOT.COM

MARSHA STEWART LIVING™ and the
 MARSHA STEWART Logo™ are trademarks of
 Martha Stewart Living Omnimedia, Inc.
 © Martha Stewart Living Omnimedia, Inc.
 All rights reserved.

Recycle Recicla

MADE IN CHINA
 HECHO EN CHINA

DISTRIBUIDO POR:
 HOME DEPOT
 2455 PACES FERRY RD., N.W.
 ATLANTA, GA 30339

4 713 105 460032

Artwork for SKU# 607110



1-3/8 IN REEDED POLE 8 FT
POSTE GRABADO DE 3,4 CM, 2,43 M

607 110

WHITE FINISH
ACABADO EN BLANCO

DIAMETER: 1-3/8 IN
DIÁMETRO: 3,4 CM
LENGTH: 8 FT
LONGITUD: 2,43 M

FOR ASSISTANCE, CALL:
SI NECESITA AYUDA, LLÁME AL:
1-877-527-0313
HOMEDEPOT.COM

MARTHA STEWART LIVING™ and the
MARTHA STEWART Logo™ are trademarks of
Martha Stewart Living Omnimedia, Inc.
© Martha Stewart Living Omnimedia, Inc.
All rights reserved.



MADE IN CHINA
HECHO EN CHINA

DISTRIBUTED BY:
DISTRIBUIDO POR:
HOME DEPOT
2455 PACES FERRY RD., N.W.
ATLANTA, GA 30339

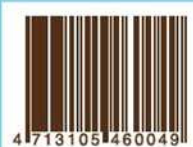

Artwork for SKU# 608086



1-3/8 IN REEDED POLE 8 FT
POSTE GRABADO DE 3,4 CM, 2,43 M

608 086

HERITAGE OAK FINISH
ACABADO EN ROBLE HERITAGE

DIAMETER: 1-3/8 IN
DIÁMETRO: 3,4 CM
LENGTH: 8 FT
LONGITUD: 2,43 M

FOR ASSISTANCE, CALL:
SI NECESITA AYUDA, LLÁME AL:
1-877-527-0313
HOMEDEPOT.COM

MARTHA STEWART LIVING™ and the
MARTHA STEWART Logo™ are trademarks of
Martha Stewart Living Omnimedia, Inc.
© Martha Stewart Living Omnimedia, Inc.
All rights reserved.



MADE IN CHINA
HECHO EN CHINA

DISTRIBUTED BY:
DISTRIBUIDO POR:
HOME DEPOT
2455 PACES FERRY RD., N.W.
ATLANTA, GA 30339



Artwork for SKU# 608763



1-3/8 IN REEDED POLE 8 FT
POSTE GRABADO DE 3,4 CM, 2,43 M

608 763

ANTIQUE MAHOGANY FINISH
ACABADO EN CAOBA ANTIGUO

DIAMETER: 1-3/8 IN
DIÁMETRO: 3,4 CM
LENGTH: 8 FT
LONGITUD: 2,43 M

FOR ASSISTANCE, CALL:
SI NECESITA AYUDA, LLÁME AL:
1-877-527-0313
HOMEDEPOT.COM

MARTHA STEWART LIVING™ and the
MARTHA STEWART Logo™ are trademarks of
Martha Stewart Living Omnimedia, Inc.
© Martha Stewart Living Omnimedia, Inc.
All rights reserved.



MADE IN CHINA
HECHO EN CHINA

DISTRIBUTED BY:
DISTRIBUIDO POR:
HOME DEPOT
2455 PACES FERRY RD., N.W.
ATLANTA, GA 30339



Artwork for SKU# 609722



609 722

**1-3/8 IN
SMOOTH POLE 8 FT**
POSTE LISO
DE 3,4 CM, 2,43 M

WHITE FINISH
ACABADO EN BLANCO

DIAMETER: 1-3/8 IN
DIÁMETRO: 3,4 CM
LENGTH: 8 FT
LONGITUD: 2,43 M

FOR ASSISTANCE, CALL:
SI NECESITA AYUDA, LLÁME AL:
1-877-527-6213
HOMEDEPOT.COM

MARTHA STEWART LIVING™ and the
MARTHA STEWART Logo™ are trademarks of
Martha Stewart Living Omnimedia, Inc.
© Martha Stewart Living Omnimedia, Inc.
All rights reserved.



MADE IN CHINA
HECHO EN CHINA

DISTRIBUIDO POR:
HOME DEPOT
2455 PACES FERRY RD., N.W.
ATLANTA, GA 30339



4 713 105 460 087

Artwork for SKU# 725796



725 796

**1-13/16 IN
REEDED POLE 8 FT**
POSTE GRABADO
DE 4,6 CM, 2,43 M

ANTIQUE MAHOGANY FINISH
ACABADO EN CAOBA ANTIGUO

DIAMETER: 1-13/16 IN
DIÁMETRO: 4,6 CM
LENGTH: 8 FT
LONGITUD: 2,43 M

FOR ASSISTANCE, CALL:
SI NECESITA AYUDA, LLÁME AL:
1-877-527-6213
HOMEDEPOT.COM

MARTHA STEWART LIVING™ and the
MARTHA STEWART Logo™ are trademarks of
Martha Stewart Living Omnimedia, Inc.
© Martha Stewart Living Omnimedia, Inc.
All rights reserved.



MADE IN CHINA
HECHO EN CHINA

DISTRIBUIDO POR:
HOME DEPOT
2455 PACES FERRY RD., N.W.
ATLANTA, GA 30339



4 713 105 460 537

Shipping mark for SKU#725796: Per ECN 15723, Print shipping mark and barcode on the top of master carton.

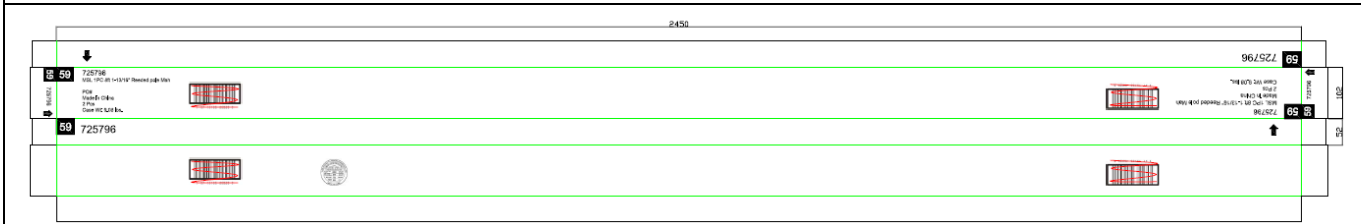

↓

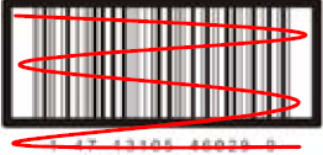
59	59	<p>725796 MSL 1PC 8ft 1-13/16" Reeded pole Mah</p> <p>PO# Made in China 2 Pcs Case Wt: 9.08 lbs.</p>	
725796 ↑			
	59	725796	
			

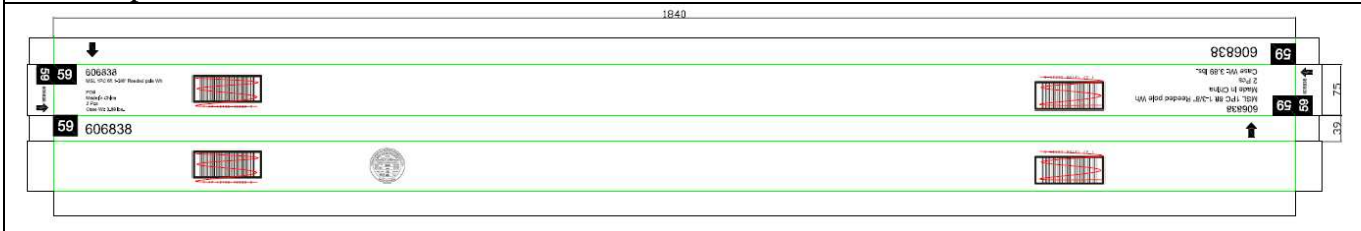

Shipping mark for SKU# 606838/ 607061/ 607070: Per ECN 15724, Print shipping mark and barcode on the top of master carton.



↓

59	59	<p>606838 MSL 1PC 6ft 1-3/8" Reeded pole Wh</p> <p>PO# Made in China 2 Pcs Case Wt: 3.89 lbs.</p>	 <small>1 47 13105 46029 9</small>
606838 ↓	59	606838	 <small>1 47 13105 46029 9</small>

Shipping mark for SKU# 607110/ 608086/ 608763/ 609722: Per ECN 15725, Print shipping mark and barcode on the top of master carton.

59	59	<p>607110 MSL 1PC 8ft 1-3/8" Reeded pole Wh Made in China 2 Pcs Case Wt: 4.73 lbs.</p>	 <small>1 47 13105 46029 9</small>
607110 ↓	59	607110	 <small>1 47 13105 46029 9</small>

Artwork for SKU# 744891



SKU 744 891
OMSID 608 522

8 FT
DECORATIVE
TRAVERSE
ROD SET
JUEGO DE VARA
TRANSVERSAL
DECORATIVA
DE 2.43 M

ANTIQUE MAHOGANY FINISH
ACABADO EN CAOBA ANTIGUO
DIAMETER: 1-13/16 IN
DIÁMETRO: 4.6 CM
LENGTH: 8 FT
LONGITUD: 2.43 M

1-13/16
inch
4.6 cm

1-13/16 inch Diameter,
good for all drapery fabrics.

4.6 cm de Diámetro, apta para
todas las telas para cortinas

MADE IN CHINA / HECHO EN CHINA

DISTRIBUTED BY / DISTRIBUIDO POR:
HOMEDEPOT
2415 PACER FERRY RD, NW
ATLANTA, GA 30329

FOR ASSISTANCE, CALL:
SINCE CE NTA AJUDA, LLAME AL:
1-877-527-0915
HOMEDEPOT.COM

MARTHA STEWART LIVING™ and the MARTHA STEWART Logo™
are trademarks of Martha Stewart Living Omnimedia, Inc.
© Martha Stewart Living Omnimedia, Inc.



4 713 1054 60544



**1-13/16
inch
4.6 cm**

**1-13/16 inch Diameter,
good for all drapery fabrics**

**4.6 cm de Diámetro, apta para
todas las telas para cortinas**

MADE IN CHINA / HECHO EN CHINA

DISTRIBUTED BY / DISTRIBUIDO POR:
HOME DEPOT
2455 PACIFIC FERRY RD, NW
ATLANTA, GA 30339

FOR ASSISTANCE, CALL:
SINECE SITA AVENDA, LLAME AL:
1-877-527-0313
HOMEDEPOT.COM



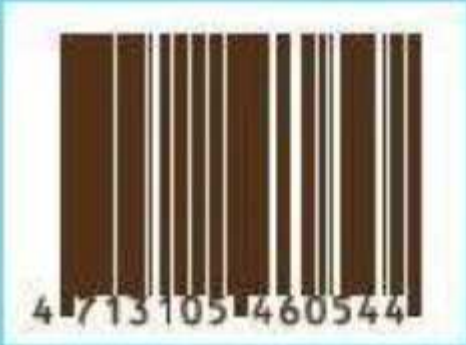

MARTHA STEWART LIVING™ and the MARTHA STEWART Logo™
are trademarks of Martha Stewart Living Omnimedia, Inc.
© Martha Stewart Living Omnimedia, Inc.



4 713 105 460544



Shipping mark for SKU# 744891

			
<p>59 744891 100% PVC 1 1/2" x 1 1/2" Tension Rod Set (10) 100% PVC 2.50lb Color: PVC 1220R BL</p>	<p>59 744891 100% PVC 1 1/2" x 1 1/2" Tension Rod Set (10) 100% PVC 2.50lb Color: PVC 1220R BL</p>	<p>59 744891 100% PVC 1 1/2" x 1 1/2" Tension Rod Set (10) 100% PVC 2.50lb Color: PVC 1220R BL</p>	<p>59 744891 100% PVC 1 1/2" x 1 1/2" Tension Rod Set (10) 100% PVC 2.50lb Color: PVC 1220R BL</p>



	<p>59 744891 </p> <p>MSL 1PC 8ft 1-13/16" Traverse Rod Set Mah Made in China 2 Sets Case Wt: 12.69 lbs.</p>	
--	---	--

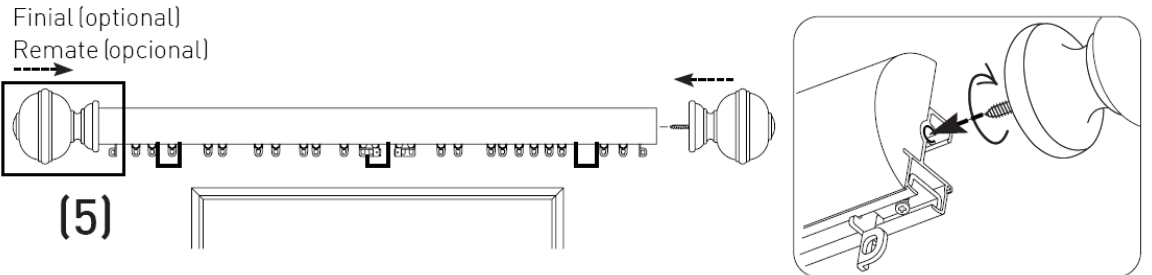
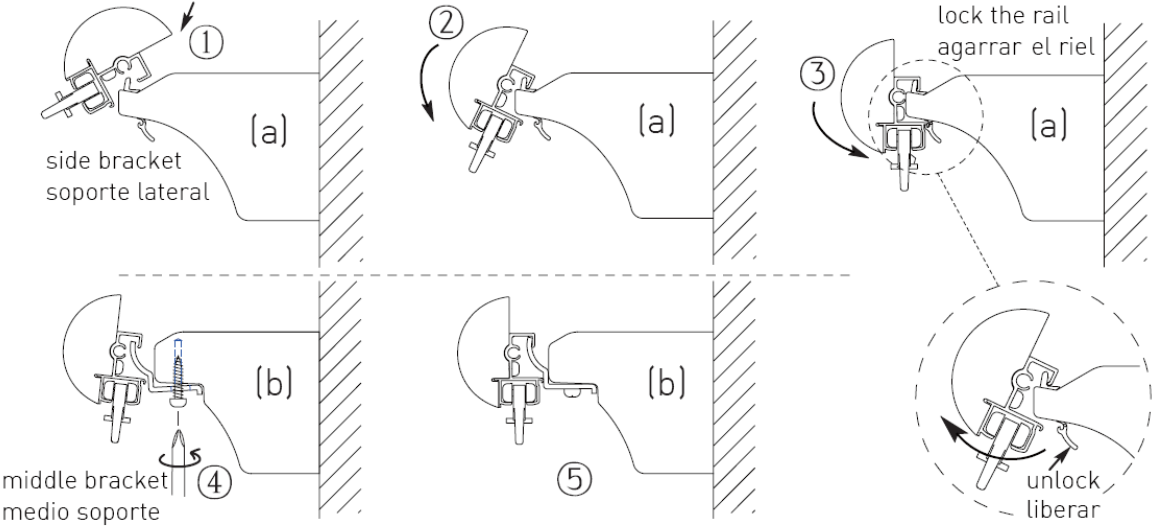
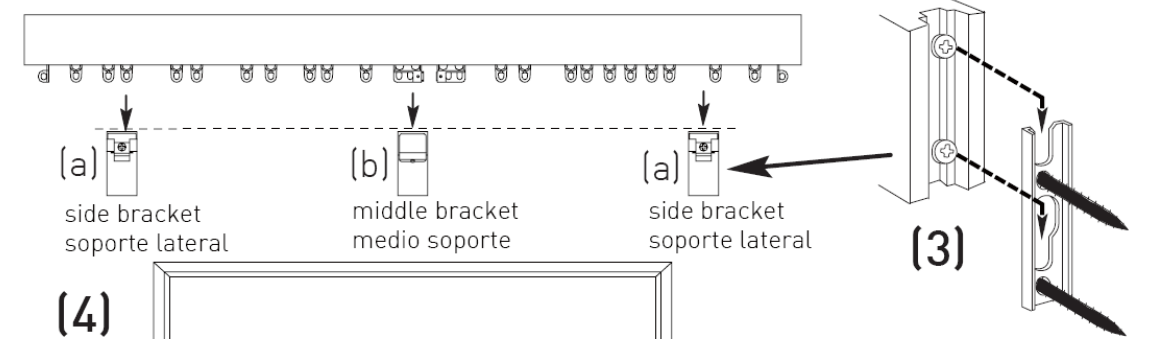
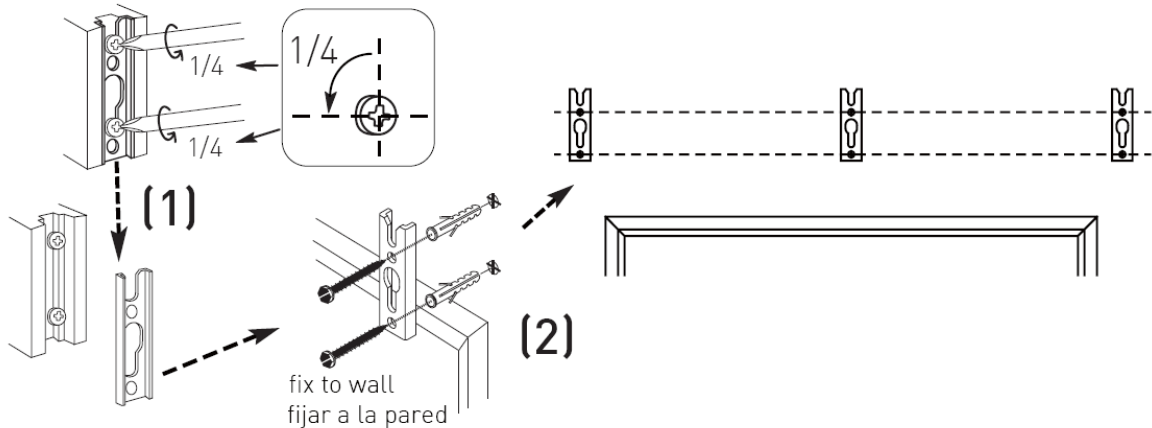

Instruction sheet for SKU# 744891

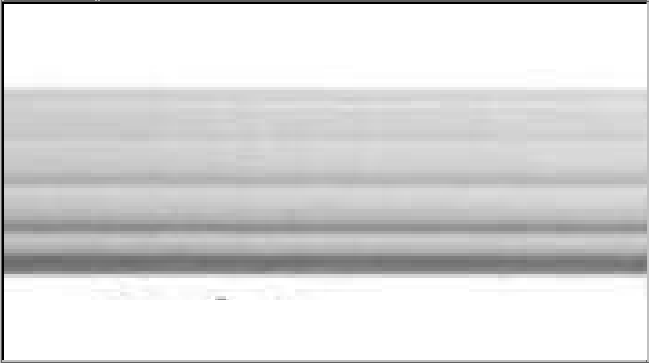
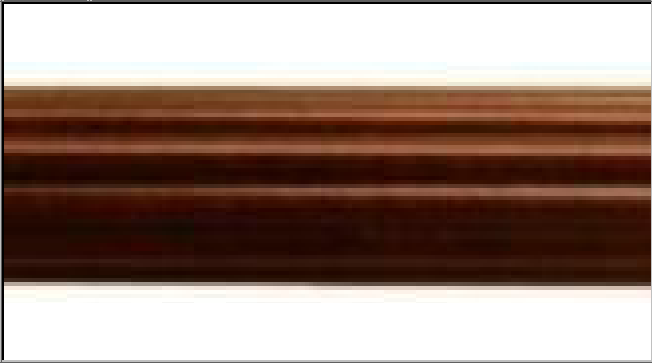
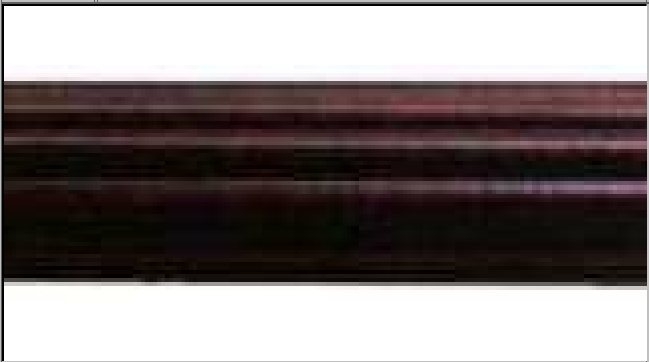
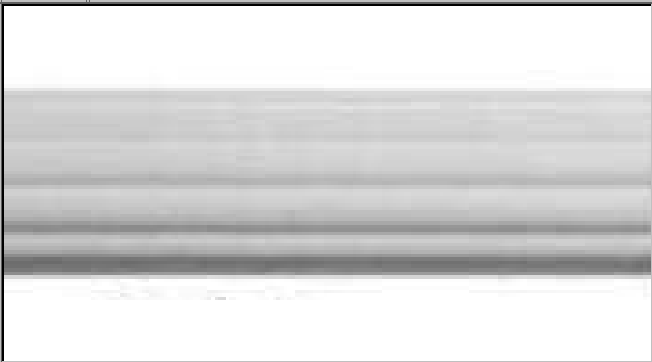

----- End of This Section -----

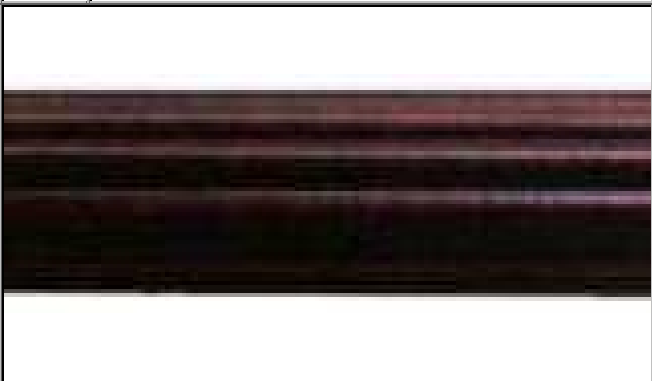
4. Product Photos

1	Overall view 33-WP-61	2	Overall view 33-WP-62
			
3	Overall view 33-WP-64	4	Overall view 33-WP-81
			
5	Overall view 33-WP-82	6	Overall view 33-WP-84
			

7	Overall view 33-WP-85	8	Overall view 46-WP-83
			
9	Overall view 46-DT-83	10	
 <p>(8513) 149-0352</p>		<p>No photo</p>	

Per ECN 21915, change metal plate, wall anchor and screw.

Change the gap from 4.8mm to 5.4mm



We found that sometime screws is too close to the metal plate gap after fixing the screws into the bottom of bracket. Sometimes this will cause it too tight to remove it.

We will change metal plate gap from the lower limit 4.8mm to upper limit 5.4mm. This will provide more room between screws and metal plate, let customer more easily to take apart metal plate.

Current

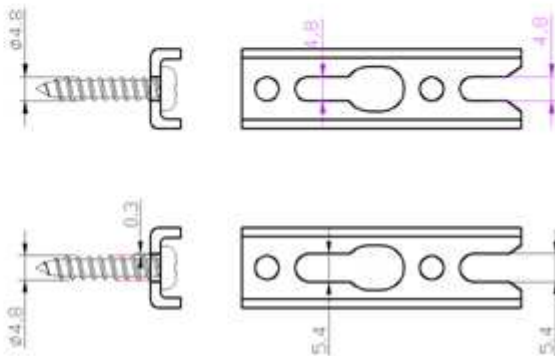

Improved

- We'll change current anchor to drywall anchor to avoid similar problem happened again.

Current anchor



Drywall anchor

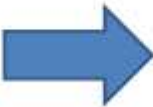

- We'll change the screw head to Philips Slotted head. Customer can use both types of screw driver.



Current



Improved



Philips Slotted >

IMPORTANT: The product photos are not intended as the color reference

----- End of This Section -----

5. Inspection Plan

5.1 General Inspection Requirement

➤ **Product:**

- ✧ Must be without any unsafe defect;
- ✧ Should be free of Cosmetic/Aesthetic defects such as: damaged/broken parts/pieces, scratches, cracks, etc.;
- ✧ Must conform to the country of destination's legal regulations;
- ✧ The unit should comply with client's requirement / approved sample (appearance and function);
- ✧ Marking(s) / label(s) on unit should be clear and should comply with legal requirements.

➤ **Packaging:**

- ✧ All units will be adequately packaged, and constructed from suitably robust materials, such that it arrives to stores in a sellable condition;
- ✧ The packaging material can protect the goods from damage during transportation;
- ✧ The shipping mark, bar code, label (such as price label), should conform to client's spec and/or approved samples;
- ✧ The packaging should comply to client's requirement / approved sample;
- ✧ Text of illustration, instruction, label and warning statement etc. must be clearly printed in user's language;
- ✧ The illustration, instruction and claim on the packaging artwork / labels must conform to the product appearance and its actual performance;
- ✧ The method and material of pallet / crate etc. should be approved by client.

➤ **Inspection Standard Adopted:**

- ✧ Refer to “THD Inspection Sampling Tool”

➤ **Sample Size determination:**

- ✧ The Inspection Level Shall refer to Most Updated Switching Rules of The Home Depot.
- ✧ Please Refer to table 5.3 to determine sample size for each audit area
- ✧ Please use “THD Inspection Sampling Tool” to generate the appropriate each SKU sample size for every PSI, which includes multiple SKUs combined in one PSI lot.
- ✧ For the inspection plan is Fix sample size, each SKU shall be drawn according to the required fix sample quantity which cannot be combined.

➤ **Acceptable Quality Level:**

- ✧ Critical Non-conformity is not allowed
- ✧ **AQL 1.0** (or special approved by THD) For Major Non-Conformity
- ✧ **AQL 4.0** (or special approved by THD) For Minor Non-Conformity

➤ **For checking item that adopt “Fix sample size”, nonconformity is not allowed.**

➤ **General defect classification:**

- ✧ **Critical Defect**
 - ◆ Defects that could result in hazardous or unsafe conditions for individuals using or maintaining the product as well as defects contravening legal regulations.
- ✧ **Major Defect**
 - ◆ Functional defects reducing the usability or solidity of the product as well as obvious visual defects reducing the sales value of the product.
- ✧ **Minor Defect**
 - ◆ Defects that are unlikely to reduce the use of the product, but nevertheless may influence the sale.

➤ **For random inspection, the following rules are applied:**

- ✧ If the same sample has several defects, only the most serious defect is counted.
- ✧ Samples with defect have to be replaced or repaired; In the case of critical defects, the entire shipment must be rejected.

5.2 Equipment List

SP Equipment	Factory Equipment
<ul style="list-style-type: none">1. Metal tape2. Bar code reader3. 3M tape/ruler/cutter4. Moisture content meter	<ul style="list-style-type: none">1. Weight scale2. Sandbags or other loading weights3. Assembly tools

5.3 Inspection Checklist

Item code	Details	Sampling size
1	Packaging Check	
A	Appearance of master carton	At least the square root of the total number of shipping package units, or otherwise defined by client, And check all cartons/ pallets/crates that were selected for sampling.
B	Shipping mark	
C	Strapping method of master carton	
D	Pack size	
2	Aesthetics / Appearance Check	
A	Instruction (sheet)/warning/warranty	Inspection Level ###
B	Appearance of unit	
C	Accessories	
D	Unit packaging	
3	Bar Code Verification	Inspection Level ###
4	Data Measurement and Test	
A	Size and weight of unit	S-1 per shipment lot, but at least 2 pcs per SKU if quantity of related SKU exceeds sample size according to S-1.
B	Full Assembly Check	
C	Load capacity	
D	Moisture Content Test of natural wood material only	
E	Coating Adhesion Test on Coating / Painting Component (if available)	2 Samples per SKU

Note: ### - Shall Refer to Most Updated Switching Rules of The Home Depot.

----- End of This Section -----

6. Defect Classification

Item code	Details	Defective Classification		
		Critical	Major	Minor
1	Packaging Check			
A	Appearance of master carton			
	• Damaged / deteriorative/wet		✓	
	• Open end is not sealed securely		✓	
	• Wrong flute direction of carton		✓	
B	Shipping mark			
	• For carton, shipping label and/or pallet/crate, shipping label less than requirement		✓	
	• Wrongly in content and format		✓	
C	Strapping method of master carton			
	• Wrong strapping method was used		✓	
D	Pack size			
	• The actual quantity does not match requirement of package		✓	
2	Aesthetics / Appearance Check			
A	Instruction (sheet)/warning/warranty			
	• Dirt / scratch / unclear / illegible / wrong / damaged / wrinkled/peeled/detached/smeared/displaced, will cause unsaleable, misunderstanding of reader, information missing etc.)		✓	
	• Dirt / scratch / unclear / illegible / wrong / damaged / wrinkled/peeled/detached/smeared/displaced, will not affect sales, although illegible but will not cause information incompleteness etc.)			✓
	• Misleading/incorrect descriptions/claims		✓	
	• Wrong label / Instruction used		✓	
	• Missing instruction/warning/warranty/label/marketing sheet (will cause safety issue)	✓		
	• Missing instruction/warning/warranty sheet/label/marketing (will not cause safety issue)		✓	
B	Appearance of unit			
	• Non functional sharp point and sharp edge (May injure customer)	✓		
	• Live insect/infestation	✓		
	• Knives, blades, needles and similar sharp foreign object contamination	✓		
	• Excessive/unpleasant odour		✓	
	• Wrong color or style or type		✓	
	• Poor coating obviously		✓	
	• Poor coating slightly			✓
	• Loose/poor connection between hook and frame		✓	

Item code	Details	Defective Classification		
		Critical	Major	Minor
	<ul style="list-style-type: none"> Deformed, damaged, broken, cracked, rusty mark, dead knot 		✓	
	<ul style="list-style-type: none"> Obvious scratched, dirty mark, chipped, glue mark 		✓	
	<ul style="list-style-type: none"> Slight scratched, dirty mark, chipped, glue mark 			✓
	<ul style="list-style-type: none"> Rough on surface 		✓	
	<ul style="list-style-type: none"> Missing piece per set 		✓	
	<ul style="list-style-type: none"> Rusted / Oxidation / corrosion on metal parts 		✓	
	<ul style="list-style-type: none"> Screw / hooks loosen and causing some parts loosed 		✓	
	<ul style="list-style-type: none"> Incorrect plating on metal part 		✓	
	<ul style="list-style-type: none"> Any missing parts or wrong type parts 		✓	
	<ul style="list-style-type: none"> Detached/ missing components 		✓	
	<ul style="list-style-type: none"> Detached/ missing components 		✓	
	<ul style="list-style-type: none"> Hard to adjust length 		✓	
C	Accessories			
	<ul style="list-style-type: none"> Missing or incorrect accessories 		✓	
	<ul style="list-style-type: none"> Mismatched accessory 		✓	
D	Unit packaging			
	<ul style="list-style-type: none"> Dirt / dust /scratches / damage / deformation on labeling or packaging material that will affect selling 		✓	
	<ul style="list-style-type: none"> Dirt / dust /scratches / damage / deformation on labeling or packaging material that will not affect selling 			✓
	<ul style="list-style-type: none"> Insufficient protection to product that will cause product damage. 		✓	
	<ul style="list-style-type: none"> Missing “Country of origin” or “Distributor or importer’s name and post address” marking or label (single unit) 		✓	
	<ul style="list-style-type: none"> Missing “Country of origin” or “Distributor or importer’s name and post address” marking or label (whole lot of certain SKU) 	Fail the shipment		
	<ul style="list-style-type: none"> Wrong size/style/color assortment within one retail unit 		✓	
3	Bar Code Verification			
	<ul style="list-style-type: none"> Bar code can not be scanned 		✓	
	<ul style="list-style-type: none"> Bar code label is damaged but still can be scanned 			✓
	<ul style="list-style-type: none"> Two bar code labels at same panel of selling package and may lead to wrong payment by double scanning. 		✓	
	<ul style="list-style-type: none"> Wrong bar code label is used (single unit) 		✓	
	<ul style="list-style-type: none"> Wrong bar code label is used (whole lot of certain SKU) 	Fail the shipment		
	<ul style="list-style-type: none"> Bar code No. on unit does not match PO list 		✓	
4	Data Measurement and Test			
A	Size and weight of unit			
	<ul style="list-style-type: none"> Measured data is out of tolerance 		✓	
B	Full assembly check			

Item code	Details	Defective Classification		
		Critical	Major	Minor
	· Cannot be assembled according to instruction manual		✓	
C	Load capacity			
	• Any permanent damage		✓	
D	Moisture Content Test of natural wood material only			
	• Moisture content exceeds the standard		✓	
E	Coating Adhesion Test on Coating / Painting Component (if available)	Reject the shipment		
	· Removal of coating is equal or more than 15% after Cross Hatching Test or / and · Specimen falls down after Tape test.			

Note 1: The above described defects are those most commonly found, but not necessarily cover all possible defects. And the defective classification is for reference only. The final decision of the defective classification would be decided by the inspector.

Note 2: The checking and defect finding evaluation should be conducted at a distance around 76 cm (when an adult extends his hand forward, normally it is distance from eye to tip of middle finger), the time duration for one position is around 3-5 seconds.

----- End of This Section -----

7. Revision History

DATE	REVISION	REVISED BY	APPROVED BY
Dec 21, 2012	Draft IR	Sally Fan	Nancy Du
Dec 21, 2012	V00, Initial Released	Sally Fan	Nancy Du
Dec 24, 2012	V01, Per customer comments: 1) Updated the packaging specification on page 5; 2) Updated the tolerance on page 2; 3) Added all related information for the moisture content test; 4) Added the related information for index# 8034.3442.4107.51761; 5) Print shipping mark and barcode on the top of master carton per ECN 15723 / 15724 / 15725; 6) Added the Finger joints & Pole curvature degree control test on page 21.	Sally Fan	Nancy Du
Dec 25, 2012	V02, Changed the pack size from 4 packs per case to 2 packs per ECN 15472 by recording.	Sally Fan	Nancy Du
Jul 18, 2013	V03, Added the information for SKU# 744891.	Aleena Feng	Nancy Du
Jul 19, 2013	V04, Updated the unit package size per vendor's feedback.	Aleena Feng	Nancy Du
Aug 21, 2014	V05, Per ECN 21915, changed metal plate, wall anchor and screw.	Sally Liu	Nancy Du

Additional tests

- 1. Finger joints: for 6' poles within 2 finger joints; for 8' poles within 3 finger points. No obvious joint mark and color aberration.**
- 2. Pole curvature degree control: 6' poles within 5mm, 8' poles within 7mm.**