

APEX[®]
DIGITAL



24" LED TELEVISION

LE2412

USER'S MANUAL

LE2412





CAUTION
RISK OF ELECTRIC SHOCK
DO NOT OPEN



Safety:

TO REDUCE THE RISK OF ELECTRICAL SHOCK DO NOT REMOVE COVER (OR BACK). NO USER SERVICEABLE PARTS ARE INSIDE. REFER TO QUALIFIED PERSONNEL ONLY.



The lightning flash with arrowhead symbol, within an equilateral triangle, is intended to alert the user to the presence of uninsulated “dangerous voltage” within the product’s enclosure that may be of sufficient magnitude to constitute a risk of electric shock to persons.



The exclamation point within an equilateral triangle is intended to alert the user to the presence of important operating and maintenance (servicing) instructions in the literature accompanying the television.

WARNING:

TO PREVENT FIRE OR SHOCK HAZARDS, DO NOT EXPOSE THIS PRODUCT TO RAIN OR MOISTURE.

NOTE TO CABLE/TV INSTALLER:

This reminder is provided to call the CATV system installer’s attention to Article 820-40 of the National Electric Code (U.S.A.). The code provides guidelines for proper grounding and, in particular, specifies that the cable ground shall be connected to the grounding system of the building, as close to the point of the cable entry as practical.

FCC REGULATORY INFORMATION:

This television has been tested and found to comply with the limits for a Class B digital device, pursuant to Part 15 of the FCC Rules. These limits are designed to provide reasonable protection against harmful interference in a residential installation. This television generates, uses and can radiate radio frequency energy and, if not installed and used in accordance with the instructions, may cause harmful interference to radio communications. However, there is no guarantee that interference will not occur in a particular installation. If this television does cause interference to other electronic equipment, which can be determined by turning the television off and on, then the user is encouraged to try to correct the interference by one or more of the following measures:

- Reorient or relocate the receiving antenna.
- Increase the separation between the equipment and television.
- Connect the equipment into an outlet on a circuit different from that to which the television is connected.
- Consult your dealer or an experienced radio/TV technician for assistance.

Any changes or modifications not expressly approved by the party responsible for compliance may void the user’s authority to operate the equipment.

Important safeguards for you and your new TV

Observing the simple precautions discussed in this booklet will provide you with many years of enjoyment and safe operation. This product complies with all applicable U.S. Federal safety requirements, and those of the Canadian Standards Association.

1. Read & Follow Instructions

All safety and operating instructions should be read and followed before the TV is operated.

2. Retain Instructions

The safety and operating instructions should be retained for future reference.

3. Heed Warnings

All warnings on the TV and in the operating instructions should be adhered to.

4. Cleaning

Unplug the TV from the wall outlet before cleaning. Do not use liquid cleaners or aerosol cleaners. Use a soft and slightly damp cloth for cleaning.

5. Water and Moisture

Do not use this TV near water, for example, near a bathtub, wash bowl, kitchen sink, or laundry tub, in a wet basement, or near a swimming pool.

6. Accessories Carts and Stands

Do not place this TV on a slippery or tilted surface, or on an unstable cart, stand, or table. The TV may slide or fall, causing serious injury to a child or adult, and serious damage to the TV.

7. Transporting the Television

A TV and cart combination should be moved with care. Quick stops, excessive force, and uneven surfaces may cause the TV and cart combination to overturn.

8. Ventilation

Slots and openings in the cabinet are provided for ventilation and to ensure reliable operation of the TV and to protect it from overheating, and these openings must not be blocked or covered. The openings should never be blocked by placing the TV on a bed, sofa, rug, or other similar surface. The TV should not be placed in a built-in installation such as a book-case or rack unless proper ventilation is provided.

9. Power Sources

This TV should be operated only from the type of power source indicated on the marking label. If you are not sure of the type of power supply to your home, consult your electronics retailer or local power company.

10. Power-Cord Protection

Power-supply cords should be routed so that they are not likely to be walked on or pinched by items placed upon or against them, paying particular attention to cords at plugs, convenience receptacles, and the point where they exit from the TV.

11. Lightning

For added protection for the TV during a lightning storm, or when it is left unattended and unused for long periods of time, unplug it from the wall outlet and disconnect the antenna or cable system. This will prevent damage to the TV from lightning and power-line surges.

12. Outdoor Antenna Grounding

If an outside antenna or cable system is connected to the TV be sure the antenna or cable system is grounded so as to provide some protection against voltage surges and built up static charges. Article 810 of the National Electrical Code (U.S.A.), ANSI/ NFPA 70 provides information with regard to proper grounding of the mast and supporting structure, grounding of the lead-in wire to an antenna discharge unit, size of grounding conductors, location of antenna-discharge unit, connection to grounding electrodes, and requirements for the grounding electrode.

Example of Grounding According to National Electrical Code Instructions

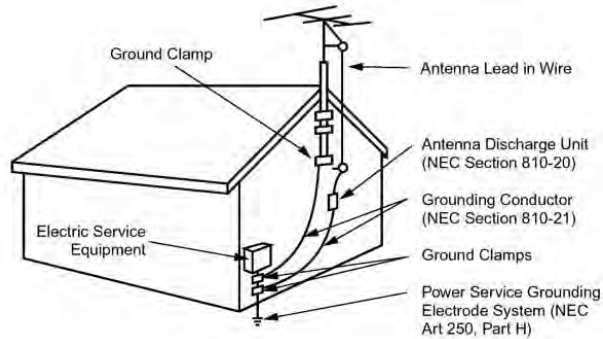

NEC - National Electrical Code

13. Power Lines

An outside antenna system should not be located in the vicinity of overhead power lines or other electric light or power circuits, or where it can fall on to power lines or circuits. When installing an outside antenna system, extreme care should be taken to keep from touching such power lines or circuits as contact with them might be fatal.

14. Overloading

Do not overload wall outlets and extension cords as this can result in a risk of fire or electric shock.

15. Object and Liquid Entry

Never push objects of any kind into this TV through openings as they may touch dangerous voltage points or short-out parts that could result in a fire or electric shock. Never spill liquid of any kind on or inside the TV.

16. Servicing

Do not attempt to service this TV yourself as opening or removing covers may expose you to dangerous voltage or other hazards. Refer all servicing to qualified service personnel.

17. Damage Requiring Service

Unplug from the wall outlet and refer servicing to qualified service personnel under the following conditions:

- a. If the power-supply cord or plug is damaged.
- b. If liquid has been spilled, or objects have fallen into the product.
- c. If the TV has been exposed to rain or water.
- d. If the TV does not operate normally by following the operating instructions. Adjust only those controls that are covered by the operating instructions as an improper adjustment of other controls may result in damage and will often require extensive work by a qualified technician to restore the product to its normal operation.
- e. If the TV has been dropped or the cabinet has been damaged.
- f. If the TV exhibits a distinct change in performance.

18. Replacement Parts

When replacement parts are required, be sure that only an authorized service technician has used replacement parts specified by Apex Digital or have the same characteristics as the original part. Unauthorized substitutions may result in fire, electric shock, or other hazards and void any warranty.

19. Safety Check

Upon completion of any service or repairs to this TV, ask the service technician to perform safety checks to determine whether the product is in proper operating condition.

20. Wall Mounting

The TV should be mounted to a wall only by a professional. The TV may slide or fall, causing serious injury to a child or adult, and serious damage to the product. Warranty shall be voided.

21. Heat

The TV should be situated away from heat sources such as radiators, heat registers, stoves, or other products (including amplifiers) that produce heat.

Getting Started



Safety Instructions	1-3
Table of Contents	4
Introduction / What's In the Box	5
Remote Control	
Remote Control Battery Install	6
Remote Control Overview	7
TV Overview	
Front and Side Panel	8
Rear Panel	9
Pedestal Removal / Wall Mounting	9

Initial Setup Before Use



Installation

Connection to Power Cord and Antenna & Cable / Satellite Box.....	10
Connection to HDMI Inputs	11
Connection to Component (YPbPr) Input	12
Connection to AV Composite Input.....	13
Connection to a Personal Computer	14
Connection to a Home Theater System	15

Initial TV Setup

Initial Setup Wizard	16
TV Channel Setup & Channel Auto Scan	17

Menu Adjustments



Picture Settings

Contrast	20
Brightness	20
Color	20
Tint	20
Sharpness	20
Color Mode	20

Audio Settings

Bass / Treble / Balance	21
Surround	21
Audio Language	21

Date & Time Settings

22

Setup Settings

Menu Language	23
Transparency.....	23
Zoom Mode	23
Noise Reduction	23
XVS	23
Restore Default	23
Closed Caption Settings	
Advanced Setting for PC	25
Parental Control - US	26
Parental Control - Canada	27

TV Settings

Favorite	28
Add/Delete	28
Channel Label	28
DTV Signal	28
Zoom Modes	29

Misc Information



Specifications	30
Troubleshooting	31
Index	32
Warranty	33

Thank you for purchasing the energy efficient Affinity LE2412 HD LED television. It has been designed to enjoy today's high definition television experience. With a display resolution of 1,920 x 1,080 (1080p) you are assured of one of the finest quality televisions available today that removes blur from fast action scenes in movies and sports. View HDTV and digital broadcasts over-the-air when connected to an antenna. Choose an outdoor antenna for the best possible reception. Visit www.antennaweb.org.

Your television offers both analog and digital inputs including two 2) High Definition Multimedia Interface (HDMI) interconnects offer the purest audio and video digital signal when connected to compatible HD sources (ie: HD set-top box, high definition blu-ray player or gaming console). Other video inputs includes an HD component, composite, and VGA terminal for connection to a computer. A coaxial digital audio (SPDIF) jack is included to connect through your home amplifier/receiver to provide a spectacular home theater sound experience.

Your new television is an ENERGY STAR certified device which meets energy saving standards to reduce power consumption and the associated cost of use. From the factory, the default picture setting is currently set in the Power Saving mode.

We recommend that you read the user manual thoroughly before use to familiarize yourself with the installation and adjustment options available to you, thereby enjoying all the features of the LE2412 for many years to come.

For peace of mind and valuable services, please take a moment to register your product at www.tmaxdigital.com

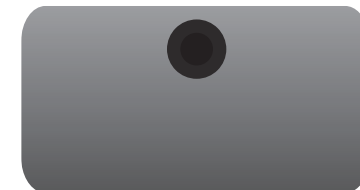

• Pedestal Base

The **LE2412** package includes the following items. Save the carton & packing for future shipping.

- Pedestal Base / Hardware
- Pedestal Instructions
- Remote Control
- AAA Batteries (2)
- Power Adapter
- Quick Start Guide
- User Manual



• Adapter



• Remote Control
• AAA Batteries x 2

Your remote control handset is powered by two (2) AAA type batteries



• To insert batteries, turn the remote control over and remove the battery cover.



• Place two (2) AAA batteries into the compartment with correct polarity.



• Replace the cover.

- When pointed towards the television, the effective range is approximately 12 feet from the front of the IR receiver, 30° to the left and right, 20° up and down.
- To avoid damage from possible battery chemical leakage, remove the batteries if you do not plan to use the remote control handset for an extended period of time. Do not mix batteries of different age and/or type. Always discard used batteries safely.
- Do not expose remote control to liquids, direct sunlight or sources of excessive heat.
- The IR receiver will not work properly if TV is in direct sunlight, the remote control is pointed off-axis or an object is in the IR path.

NOTE: Improper use of batteries can result in a chemical leakage or explosion.

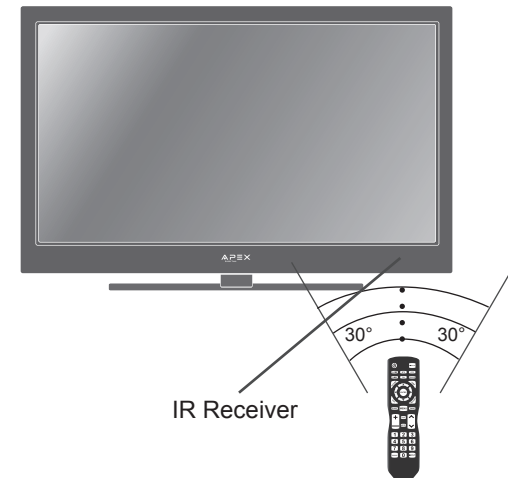

Functions can be controlled using the remote control handset

- 1. Power** – Turn the LCD display ON or OFF (Standby).
- 2. Display** – Provides program information currently viewed.
- 3. Audio** – Select Dynamic, Standard, Movie or User sound modes. (pg.19)
- 4. MTS** – Press to select a program's second audio channel (if available). (pg. 19)
- 5. CCD** – Select closed caption subtitles (if available) OFF > ON. (pg.22)
- 6. Guide** – Press to review scheduled programming for the current channel viewed.
- 7. FAV** – Press to display a list of favorite TV channels you have added. (pgs. 26)
- 8. Freeze** – Pause and still-frame the current image on the display. Press again for live TV.
- 9. Picture** – Select from various preset picture modes: Dynamic > Standard > Movie > Power Saving > Personal.(pg.20)
- 10. Temp** – Select the Color Temperature: Cool > Normal > Warm. (pg. 18)
- 11. ▼▲◀▶Arrows/ Enter** – Navigate menus to make selections. Press **ENTER** to confirm.
- 12. Exit** – Press to exit a menu that is displayed.
- 13. Return** – Press to return to the previous menu displayed.
- 14. Sleep** – Press to activate the Sleep function to turn off the TV automatically; OFF > 5 Min > 10 Min > 15 Min > 30 Min > 45 Min > 60 Min > 90 Min >120 Min > 180 Min > 240 Min > OFF
- 15. Menu** – Press to display the Main menu.
- 16. Zoom** – Select viewable Wide > Zoom > Cinema > Normal. (pg. 27)
- 17. Volume (+/-)** – Adjust volume up (+) or volume down (-).
- 18. Last** – Press to select between the current and previously viewed TV channel.
- 19. Mute** – Press to temporarily turn sound off. Press again to resume.
- 20. Channel** – ▲ / ▼ scan channels up (▲) or channels down (▼).
- 21. Numbers / Dash** – Select desired TV channel directly. For example: to select digital channel four, press “4” “-” “1” (4-1).
- 22. Input** – Press to display all input sources on screen. (pgs. 11-14)

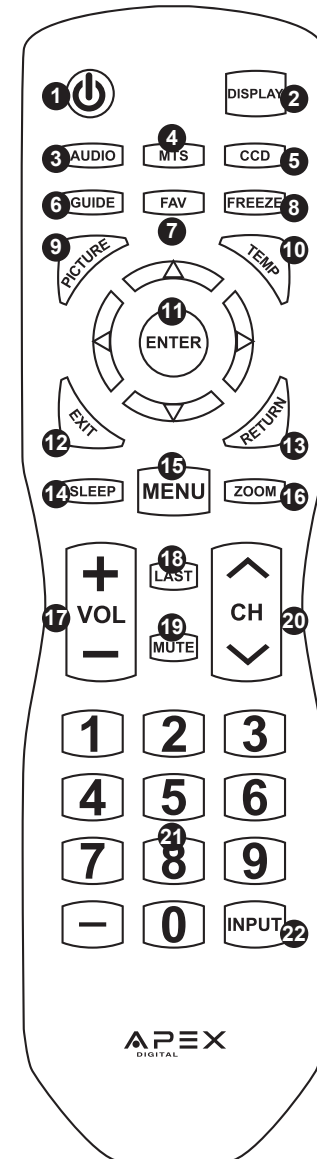

Note: When using the remote control, point it directly at the TV.

Side Panel



A soft blue light illuminates when television is powered ON

IR Receiver

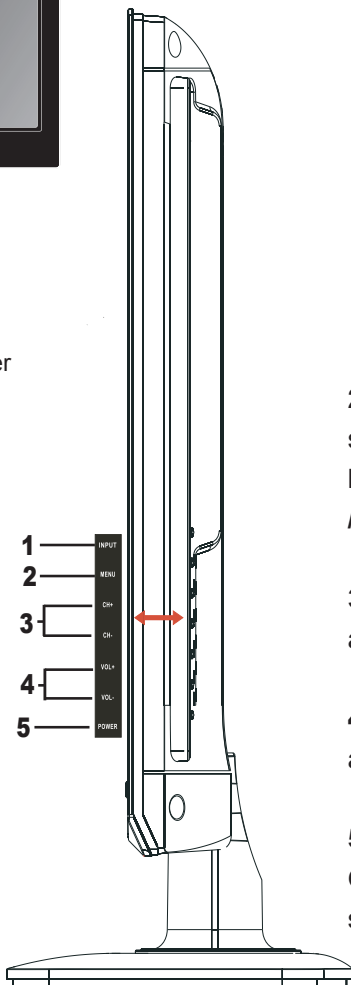

1. Input - After connecting your DVD, cable box, etc., select the appropriate input source to view. Press the INPUT button to display input options. Press **CH+** / **CH-** buttons to highlight an input. Press **VOL+** to select.

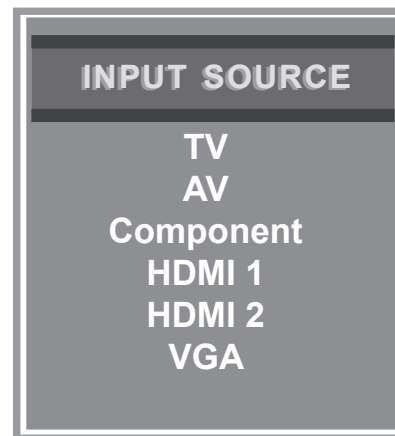

2. Menu - Press the MENU button to display. Press **VOL+** to select from the 6 menu options available to you. Press **CH+** / **CH-** buttons to select a feature from the selected menu then press **VOL+** / **VOL-** to adjust settings.

3. Channel (CH+ / CH-) - Press the **CH+** / **CH-** buttons to select a channel in TV mode.

4. Volume (VOL+ / VOL-) - Press the **VOL+** / **VOL-** buttons to adjust volume up or down.

5. Power - Press the POWER button to turn the LCD display ON/ OFF (standby). When the power is on, the blue LED illuminates. The screen image will appear within a few seconds.

TV REAR PANEL

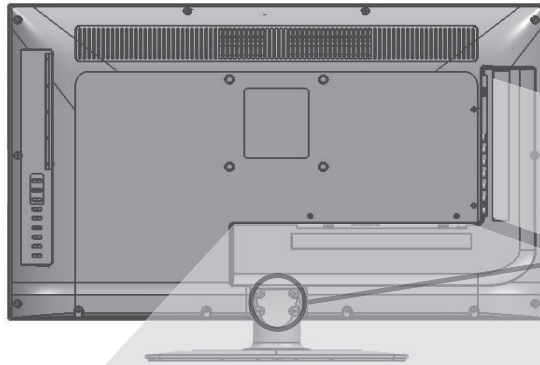

Wall Mounting

It is recommended that you call your local TV dealer or a licensed contractor to secure the television to the wall using a suitable VESA 75 x 75 wall mount hardware.

Removal of TV Pedestal for Wall Mounting

To remove the pedestal base from the television, unscrew the (4) Philips head screws and remove the entire assembly.

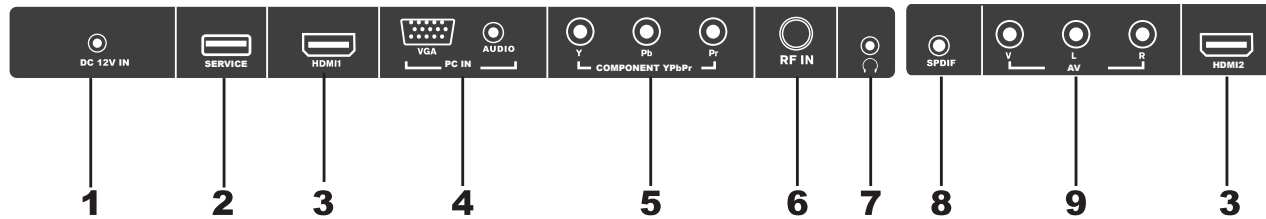

1. DC 12V IN – Connect only to included 12V Power supply

2. SERVICE Port - For service technician use only.

3. HDMI Inputs (2) - Connects to digital AV equipment that feature HDMI connectivity. HDMI supports enhanced high definition video and up to 7.1-channel digital audio all from one cable. Recommended for best performance. HDMI cable not included.

4. PC IN - VGA Input - Connect an optional VGA cable (not included) from your personal computer .

PC Audio Input (3.5mm) - 3.5mm audio cable (not included) for sound.

5. Component Y Pb Pr Input - Connect to an AV device that features component (Y Pb Pr) video and audio output jacks.

6. RF Input - Connect an antenna or cable connection for television reception.

Note: Use an outdoor antenna, cable or satellite for best reception.

7. Headphone Jack - Connect a stereo headphone (3.5mm – not included) for private listening.

8. SPDIF - Connect an optional coaxial digital cable (not included) through a compatible amp/receiver to enjoy superior audio sound.

9. AV Input - Connect an external device to the composite VIDEO (V) and AUDIO (L/R) output jacks found on most video equipment.

Connecting to DC 12V IN

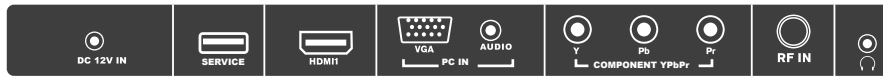

DC Adaptor

How to connect with Power Cord

- Connect the DC Adaptor from your TV to the Power Cable.

It is strongly recommended for best broadcast reception, to use digital cable, satellite, or a high quality roof top antenna.

Roof Antenna / Cable Outlet Installation



TV SIDE PANEL

How to connect to an indoor or rooftop antenna

- Connect the RF coaxial (75 ohm) cable from your existing roof top/indoor antenna, or wall outlet. Finger tighten the RF-connector end to the TV input on the rear panel.
- See pages 16-17 for TV setup and Channel Auto Scan.
- Tune to TV programming directly from the television tuner.

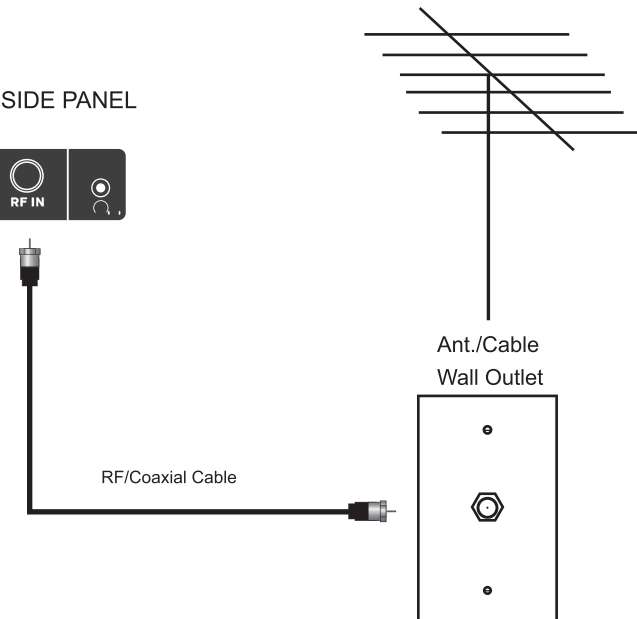

Digital Cable / Satellite Set Top Box

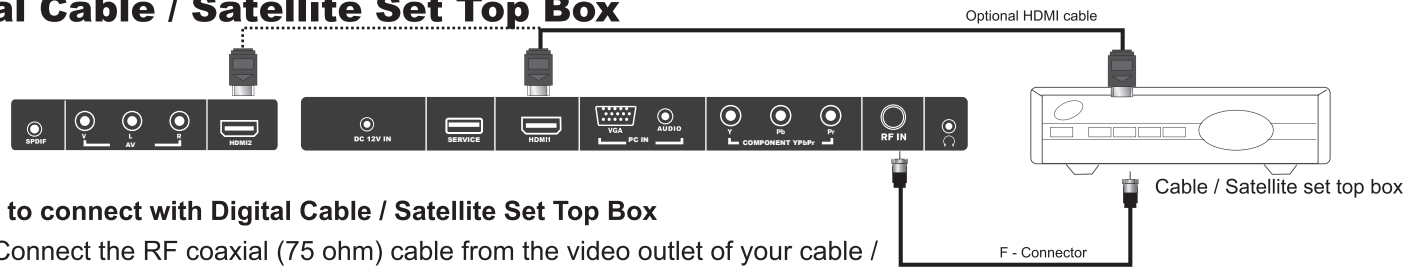

How to connect with Digital Cable / Satellite Set Top Box

- Connect the RF coaxial (75 ohm) cable from the video outlet of your cable / Satellite box to the RF input on the TV's rear panel. Select Ch. 3 or 4 on the TV and select a channel.
- For greater performance, if possible, use component or an HDMI installation. (shown) Refer to your set top box user manual.
- See pages 16-17 for TV setup and Channel Auto Scan.

Connecting to an HD Set-Top Box or Blu Ray DVD Player Using HDMI

TV REAR PANEL

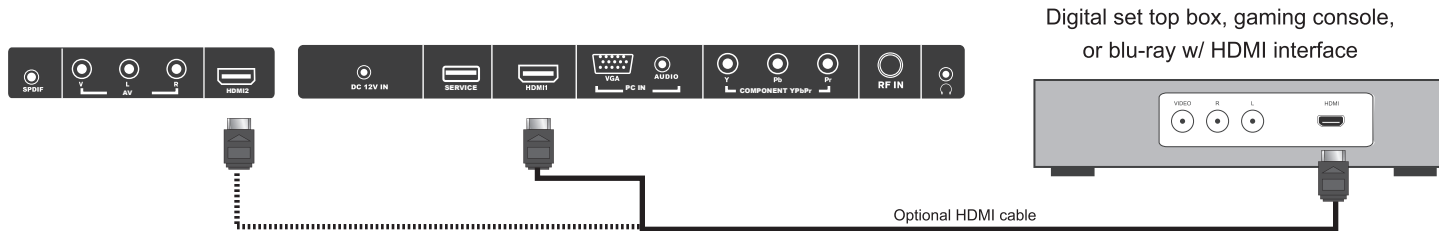

For BEST video performance

Connect to external equipment that offers HDMI, an uncompressed, all digital video / audio interface found on today's HD digital set top boxes and blu-ray players. Use of this pure digital technology offers enhanced high definition video and digital audio all via a single cable. There are two (2) HDMI inputs available for use with devices such as an HD set top box, gaming console and blu-ray player.

How to Connect HDMI

- From your external digital equipment, connect an HDMI cable from the HDMI output to the HDMI input on the TV's rear panel.

How To Use

- Press the INPUT button on the remote control. Use ▼▲ arrow buttons to highlight the input to view (HDMI 1, 2) then press ENTER.

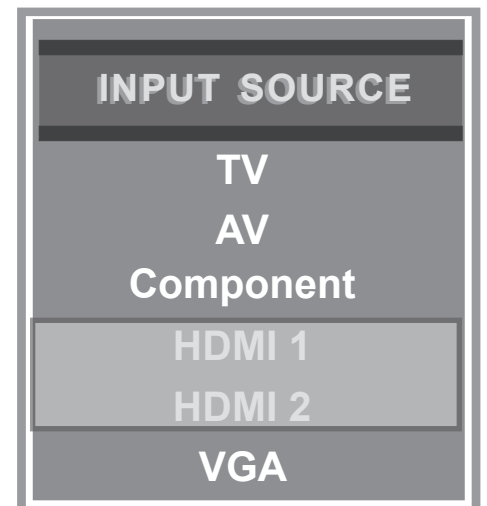

Connecting External Equipment to Component Video IN (YPbPr) on your television

TV REAR PANEL

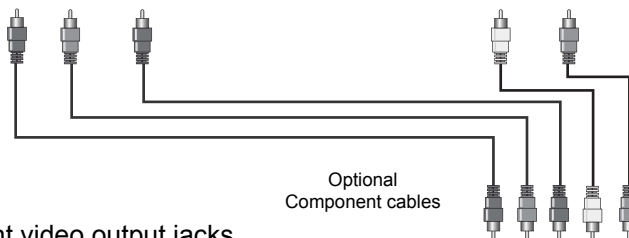

Optional Component cables

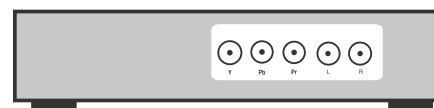

Digital set top box, gaming console or DVD

For BETTER video performance

Connect to external equipment that features component video output jacks for great performance. Use Component YPbPr component video and audio inputs with a set top box, gaming console or DVD player.

How to Connect Component

- When connecting external equipment to your television, match the colors of the connecting jacks (Video: Blue, Green, Red; Audio: White/Red).
- Connect optional component video cables (blue, green, red) from the video output jacks (Y, Pb, Pr) on your external equipment to the Component YPbPr input on the TV's rear panel.
- Connect white/red audio cables for sound from the audio (L/R) output jacks on your external equipment to the Component YPbPr L/R input on the TV's rear panel.

How to Use

- Press the COMP button on the remote control **or**
- Press the INPUT button on the TV remote control. Use ▼▲ arrow buttons to highlight the input to view (Component) then press ENTER.

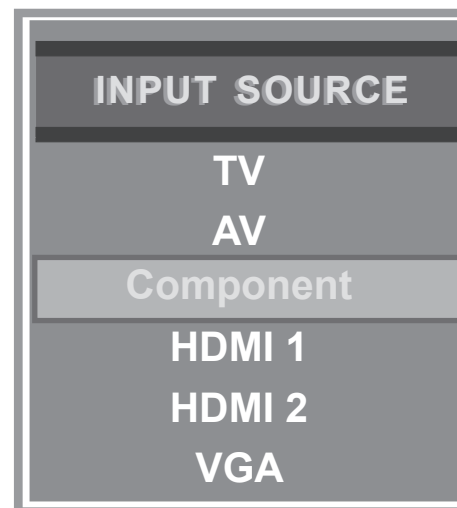

Connecting External Equipment to AV Composite IN on your television

TV SIDE PANEL

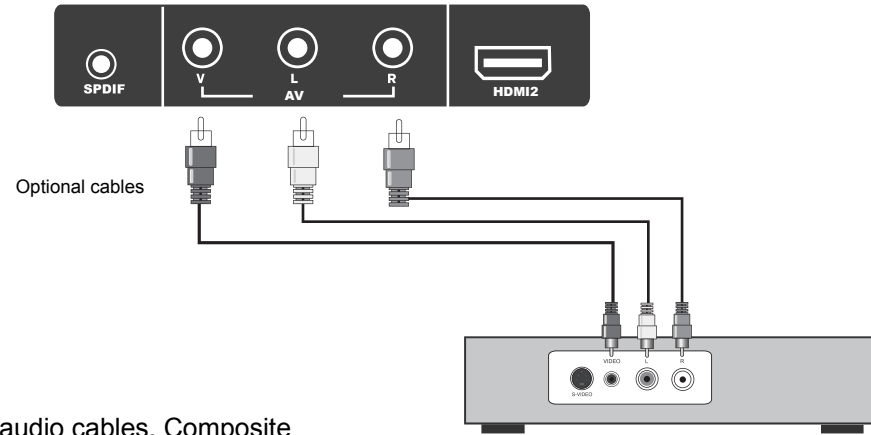

Set top box, gaming console, DVD

For GOOD video performance

Connect to external equipment using optional video and audio cables. Composite output jacks are available on most set top boxes and DVD players. (Component and HDMI connections are recommended for best performance, if possible).

How to Connect Composite AV

- When connecting external equipment to your television, match the colors of the connecting jacks (Video: Yellow; Audio: White/Red).
- Connect the yellow video cable from the video output jack on your external A/V equipment (ie: DVD player, set top box) to AV input on the TV's rear panel.
- Connect the white/red audio cables for sound from the audio (L/R) output jacks on your external equipment (ie: DVD Player, set top box) to the AV (L/R) jacks on the TV's rear panel.

How to Use

- Press the AV button on the remote control **or**
- Press the INPUT button on the remote control. Use ▼▲ arrow buttons to highlight the input to view (AV) then press ENTER.

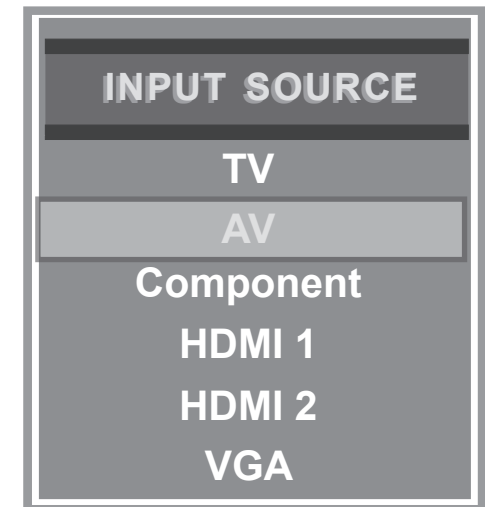

Connecting a Personal Computer with VGA to your television

TV REAR PANEL

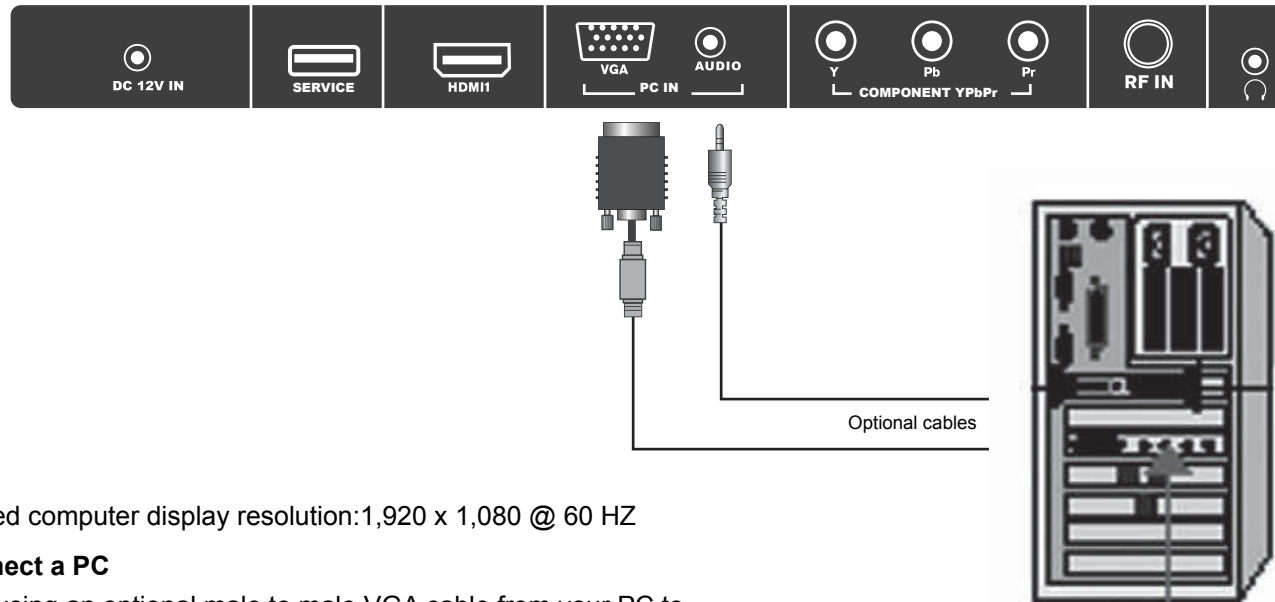

Recommended computer display resolution: 1,920 x 1,080 @ 60 HZ

How to Connect a PC

- Connect using an optional male to male VGA cable from your PC to the VGA input on the TV's rear panel.

How to Connect Audio sound

- Connect an optional 3.5mm audio cable from the computer's mini audio output jack to the audio input on the TV's rear panel.

How to Use

- Press the INPUT button on the remote control. Use ▼▲ arrow buttons to highlight the input to view (VGA) then press ENTER.

NOTE: If your PC uses a standard signal mode, the screen will adjust automatically.

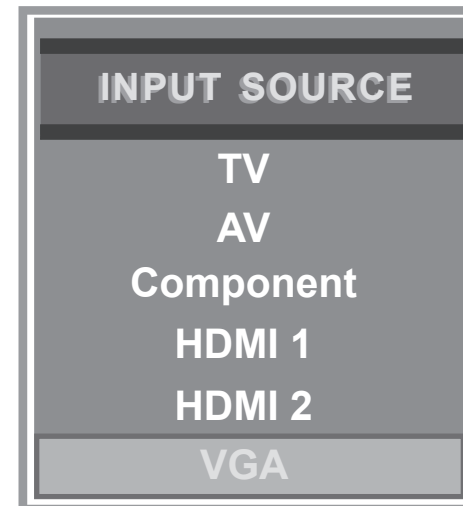

Connection to a Home Theater Audio System

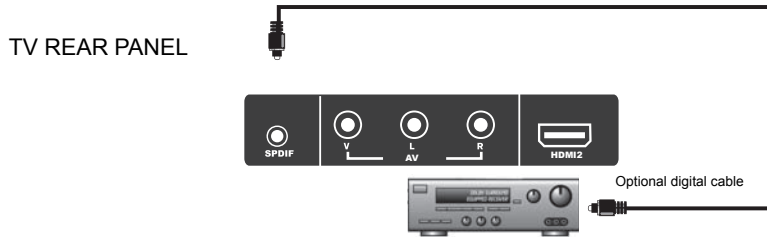

For BEST audio performance

Connecting to a Home Theater System

Dolby Digital can deliver optimal 2 channel stereo or 5.1 surround sound with five discrete full range channels separate channel for a subwoofer.

Enjoy optimal sound reproduction from your system with a Dolby Digital amplifier that incorporates a digital coaxial input. Connect an optional digital cable directly to the television's SPDIF audio output to listen through all inputs except VGA. (VGA input does not support digital audio)

How To Setup Digital Output*

- Press the MENU button on the remote control.
- Press the right ► arrow button to select AUDIO.
- Press the down ▼ arrow button to highlight SPDIF type ► Raw or PCM*

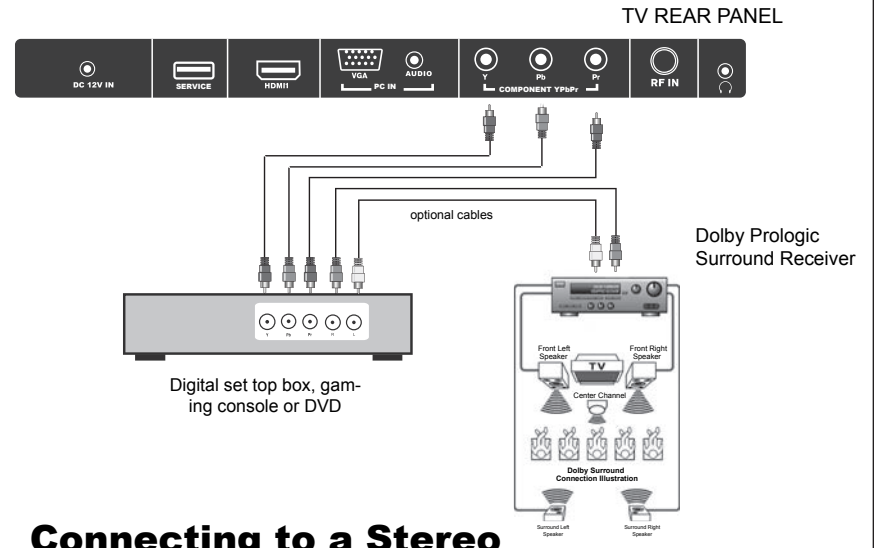
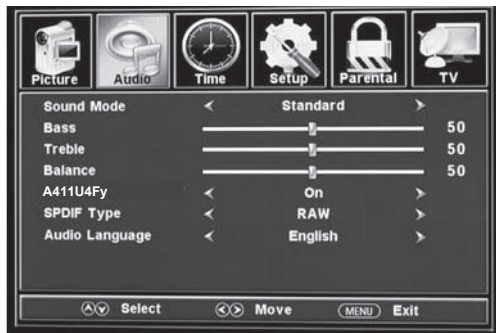

Connecting to a Stereo Receiver/Amplifier

Enjoy realistic sound from a stereo / receiver amplifier or Dolby Pro Logic sound system when connected to your AV equipment.

Example: Diagram illustrates the connection of audio cables from your AV equipment to a stereo receiver instead of the audio (L/R) jacks on the TV's rear panel.

NOTE: When audio cables are connected to a stereo / receiver amplifier, no audio sound will be heard from the TV's built-in speakers.

How to Use (Video)

Press the appropriate INPUT button on the remote control. Use ▼▲ arrow buttons to highlight the input to view then press ENTER.

How to Use (Audio)

Select the appropriate input from your audio equipment.

*NOTE: Refer to the User Manual from your home theater equipment for recommended audio settings.

Initial Setup Wizard

Select Language

Please select a Language

Welcome to the Apex Digital Setup Guide.

English This guide will assist you in setting up and managing your channels, some HDTV functions, cable and satellite connections, and gaming, Blu-ray and DVD devices.

Spanish

French

Use the Up and Down arrows on your remote control to choose a language for messages, menus and information on-screen.

◀▶▲▼ Select Enter:Next

Time Zone

Please select a Time Zone

Hawaii

Alaska

Pacific

Mountain

Central

Eastern

Use the Up and Down arrows on your remote control to select a time zone.

Go Back

◀▶▲▼ Select Enter:Next

Set Wizard

Power Optimization Mode

Home

Showroom

Use the Up and Down arrows on your remote control to select your preferred Power Optimization mode.

Select "Home" to optimize settings for Energy Star qualification.

Select "Showroom" to optimize settings for a retail or demonstration situations.

Go Back

◀▶▲▼ Select Enter:Next

Set Wizard

Power Optimization Mode

Use the Up and Down arrows on your remote control to select your preferred Power Optimization mode.

- Home
Select "Home" to optimize settings for Energy Star qualification.
- Showroom
Select "Showroom" to optimize settings for a retail or demonstration situations.

Go Back

◀▶⏪⏩:Select Enter:Next

What device(s) would you like to connect?

- Connect a Blu-Ray, DVD player, gaming or similar device.
- Connect a Cable or Satellite Receiver using HDMI, Component, or AV (Composite) cable.(Recommended for higher picture quality.)
- Connect a Cable or Satellite Receiver using a Coaxial cable (Low quality - Not recommended for most viewing.)
- Connect an indoor/outdoor*over-the-air*Antenna for local channels only.

Go Back

◀▶⏪⏩:Select Enter:Next

INPUT SOURCE

- TV
- AV
- Component
- HDMI 1
- HDMI 2
- VGA

Cable or Satellite Receiver Connection

Use the Left/Right arrows on your remote control to select the input connected to the set-top box?

- HDMI
- Component
- AV

We recommend HDMI or Component connections for optimal picture quality. Refer to the Instruction Manual or Quick Setup Guide to help determine which connection is right for your equipment.

Note: if you go into the next menu, and you want to go back, you should go into the TV mode firstly.

Go Back

◀▶⏪⏩:Select Enter:Next

Scan Channels from the Antenna or Cable service.

- Antenna[ATSC]
- Cable service

Use the Up and Down arrows on your remote control to make your selection.

Go Back

◀▶⏪⏩:Select Enter:Next

Scan Channels from the Antenna or Cable service.

- Antenna[ATSC]
- Cable service

Use the Up and Down arrows on your remote control to make your selection.

Go Back

◀▶⏪⏩:Select Enter:Next

Initial Setup Wizard

Channel Scan

Cable Service

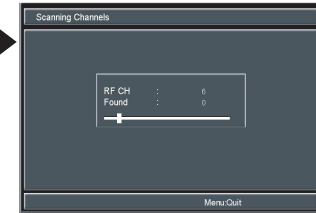
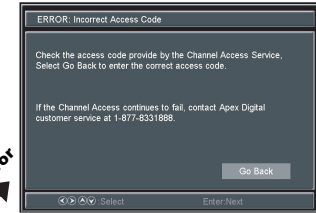
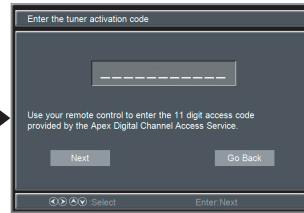
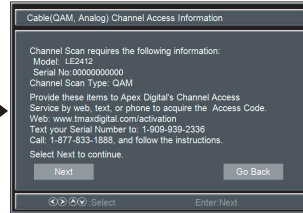
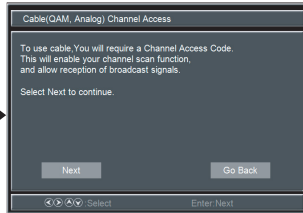
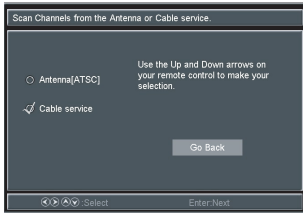

To receive the Channel Access Code:
 Go to Web: www.tmaxdigital.com/activation
 Text your 18-digit S/N to: 1-909-939-2336
 Call: 1-877-833-1888

Antenna ATSC

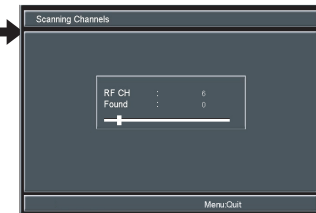
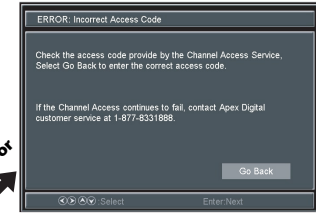
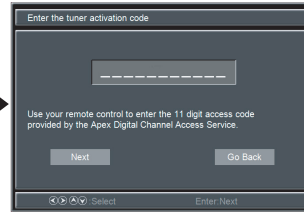
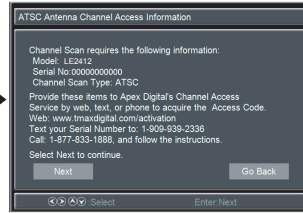
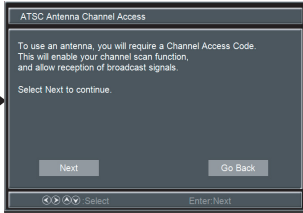
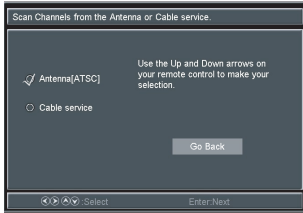

How to Navigate:

- Press the ▲ ▼ arrow button to highlight the item you want.

NOTE: 1. TV reception when using an indoor/outdoor antenna is dependent on local terrain, tall buildings and distance from local area TV transmission towers.

2. The Channel Access Codes are different for ATSC and cable .

Select antenna options and perform Channel Auto Scan to receive television channels that will be stored into the TV tuner memory.

To enter TV Mode:

- Press the **MENU** button
- Using the ◀ ▶ arrow buttons; scroll to highlight **TV mode**
- Press the down ▼ arrow button to highlight **CABLE** or **AIR**

Select **CABLE** if you subscribe to a pay television service without a set top box.

• Using the ◀ ▶ arrow button to highlight **CABLE**.

• Press the ▼ arrow button to select **AUTO SCAN**. Press **ENTER** and the cursor will move up and **CABLE SYSTEM** will be displayed next.

• Press the ▶ arrow button to select **STD > IRC > HRC > Auto** (Auto is recommended).

• Press the down ▼ arrow button to select **Auto Scan** and press **ENTER**.

• **Channel Auto Scan** may take several minutes to complete.

Cable Mode

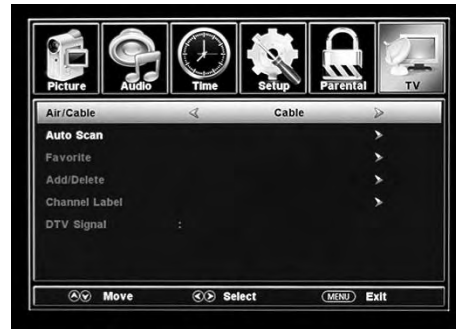

Air Mode



Select **AIR** when connected to an indoor/outdoor antenna.

• Press the ◀ ▶ arrow button to highlight **AIR**.

• Press the down ▼ arrow button to select **Auto Scan** then press the ▶ right arrow button twice to start Channel Auto Scan.

• **Channel Auto Scan** may take several minutes to complete.

NOTE: For cable or satellite users without an indoor/outdoor TV antenna, there is no need to run Channel Auto Scan. Connect your cable or satellite set top box to one of the available inputs on the TV for viewing. See pages 11-13 for connection details.

The **PICTURE** menu offers options to enhance and refine the picture displayed on your TV based on ambient room light and personal preferences. Adjustment options include contrast, brightness, color, sharpness and color temperature.

How to Navigate:

Press the **MENU** button on the remote control. Navigate using ◀▶ arrow buttons to select **PICTURE**. Press the down ▼ arrow button to highlight **PICTURE MODE**, then press the ▶ arrow button to select your viewing preference from 4 factory options:

STANDARD > DYNAMIC > MOVIE > POWER SAVING * > PERSONAL . The STANDARD setting is recommended for most viewing environments.

Depending on the ambient light level in the room, you may find one of the other options more pleasing.

To make more critical adjustments based on your own preferences in PERSONAL:

- Press down ▼ arrow button to highlight **Contrast**. Navigate using the ◀▶ arrow buttons to increase or decrease contrast intensity.
- Press down ▼ arrow button to highlight **Brightness**. Navigate using the ◀▶ arrow buttons to increase or decrease overall brightness.
- Press down ▼ arrow button to highlight **Color**. Navigate using the ◀▶ arrow buttons to increase or decrease color intensity.
- Press down ▼ arrow button to highlight **Tint**. Navigate using the ◀▶ arrow buttons to adjust colors toward green or reddish tint.
- Press down ▼ arrow button to highlight **Sharpness**. Navigate using the ◀▶ arrow buttons to soften or view crisper edges in the picture.
- Press down ▼ arrow button to highlight your **Color Mode** preference. Navigate using the ◀▶ arrow buttons to select COOL (more bluish tone), NORMAL or WARM setting.

*The **POWER SAVING** mode adjusts the brightness of the TV in order to save energy and reduce power consumption.



Note: When adjustments are complete, you may select another menu by pressing the Menu button.

The **AUDIO** menu offers options to make sound enhancements while listening through the built-in speakers or to select digital audio options when connected to a Dolby Digital receiver through a (SPDIF) coaxial digital output.

How to Navigate:

Press the **MENU** button on the remote control. Navigate using ◀▶ arrow buttons to select **AUDIO**. Press the ▼ arrow button to highlight **SOUND MODE**, then press the ▶ arrow button to select your sound preference from 4 factory options: **PERSONAL > STANDARD > MUSIC > MOVIE**.

To make more critical sound adjustments based on your own preferences in **PERSONAL**:

- Press down ▼ arrow button to highlight **Bass**. Navigate using the ◀▶ arrow buttons to increase or decrease low frequency intensity.
- Press down ▼ arrow button to highlight **Treble**. Navigate using the ◀▶ arrow buttons to increase or decrease high frequency intensity.
- Press down ▼ arrow button to highlight **Balance**. Navigate using the ◀▶ arrow buttons to adjust sound towards the left or right speaker.
- Press down ▼ arrow button to highlight **Surround**. Press the ▶ arrow button to turn the dimensional surround effect ON or OFF (for built-in speakers only).
- Press down ▼ arrow button to highlight **SPDIF type**. Navigate using the ◀▶ arrow buttons to select between PCM (Analog Audio) > RAW (Digital Audio). See page 15.

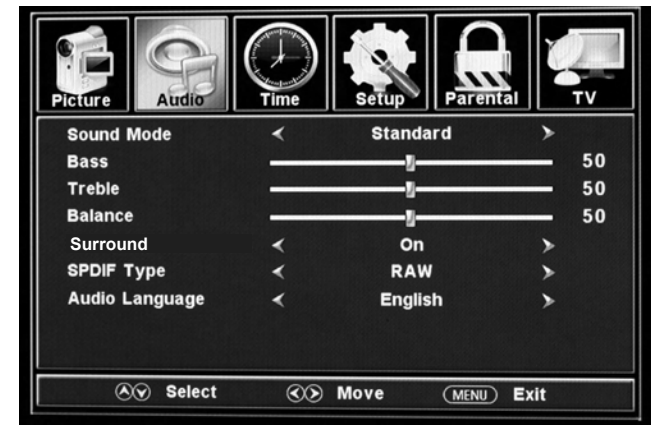

- Press down ▼ arrow button to highlight **Audio Language**. Navigate using the ◀▶ arrow buttons to select to listen to an alternative language broadcast (if available) English > Spanish > French.

Note: This feature is not available when text is grayed out.

(You may select an alternative language using the remote control by pressing **MTS**)

Note: When adjustments are complete, you may select another menu by pressing the Menu button.

The **TIME** menu includes adjustment of settings for your local time zone and daylight savings time. The clock will adjust automatically after you perform Channel Auto Scan of available broadcast channels broadcasting in your area. (See page 17 for TV Setup)

How to Navigate:

Press the **MENU** button on the remote control. Navigate using arrow ◀ ▶ buttons to select **TIME**.

- Press down ▼ arrow button to highlight **Sleep Timer**. Then press the ▶ arrow button to select time to view before television timer turns off: **5 Min > 10 Min > 15 Min > 30 Min > 45 Min > 60 Min > 90 Min > 120 Min > 180 Min > 240 Min > OFF**.
- Press down ▼ arrow button to highlight **Time Zone**. Then press the ▶ arrow button to select between: **EASTERN > CENTRAL > MOUNTAIN > PACIFIC > ALASKA > HAWAII**.
- Press down ▼ arrow button to highlight **Daylight Savings Time**. Navigate using the ◀ ▶ arrow buttons to turn this feature on or off.

Note: This feature is not available when text is grayed out.



Note: When adjustments are complete, you may select another menu by pressing the Menu button.

In the **SETUP** menu you may change the initial set up of preferences that include settings for language, menu display, computer monitoring, closed captions, enhancement of black detail in the picture and resetting your TV back to its factory default status.

How to Navigate:

Press the **MENU** button on the remote control. Navigate using arrow ◀▶ buttons to select **SETUP**. Gain access to display options by pressing the down ▼ arrow button to highlight **Menu Language** or other options, then press ▶ arrow button on your remote to select.

- Other languages include Spanish and French.

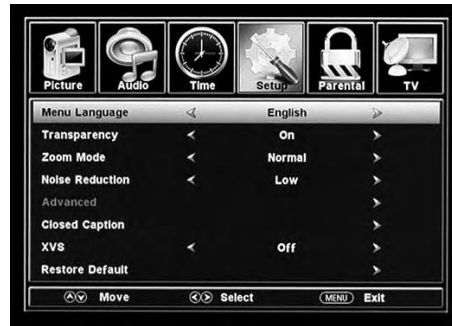

- Highlight **Noise Reduction**. Navigate using the ◀▶ arrow buttons to reduce video noise: Off > Low > Medium > High (Default setting: Low)

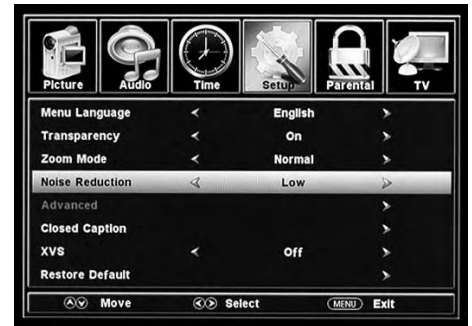

- Highlight **Transparency**. Navigate using the ◀▶ arrow buttons to turn Off ▶ On the translucent effect of the User menu.



- Highlight **XVS**. Navigate using the ◀▶ arrow buttons to select: Off > On. XVS provides noticeable black detail enhancement that may be preferred.



- Highlight **Zoom Mode**. Navigate using the ◀▶ arrow buttons to select the viewing mode displayed: Normal > Wide > Zoom > Cinema. (This feature is also available on the remote control. See page 27)

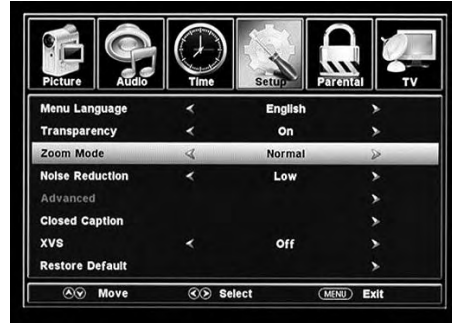

- Highlight **Restore Default**. Press the ▶ arrow button to automatically set all adjustments back to their original settings.



When prompted, Select "Yes" to confirm.



NOTE: Closed Caption and Advanced are features described on the following pages.

The **SETUP** menu includes adjustments for activating the **Closed Caption** feature for display on the television and customizing CC display types and font styles.

How to Navigate:

Press the **MENU** button on the remote control. Navigate using arrow ◀▶ buttons to select **SETUP**. Press the down ▼ arrow button to highlight **Closed Caption**.

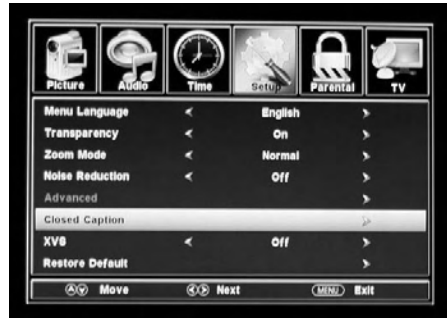

- Press down ▼ arrow button to highlight **Advanced Selection**. Navigate using the ◀▶ arrow buttons to select Service 1-6.



- Press down ▼ arrow button to highlight **CC Mode**. Navigate using the ◀▶ arrow buttons select Off > On > CC on Mute.



- Press down ▼ arrow button to highlight **Option**. Press the ▶ arrow button to enter a menu with options to customize text fonts, colors and opacities.



- Press down ▼ arrow button to highlight **Basic Selection**. Navigate using the ◀▶ arrow buttons select CC 1-4, Text 1-4.



Note: When adjustments are complete, you may select another menu by pressing the Menu button. Features are not available when text is grayed out.

In the **SETUP** menu you may adjust the position of images displayed on screen once you connect an input signal from your **PC**. Recommended resolution is 1,366 x 768. For use with a laptop computer, refer to your computer's owner manual on instruction for proper display output. If your PC system uses a standard signal mode, the screen will adjust automatically. Connect an optional 3.5mm audio cable for stereo sound. See page 14 for details.

How to Navigate:

After connecting to a **PC**, press the **VGA** button on your remote control. Press the **MENU** button on the remote control and navigate using arrow ◀ ▶ buttons to select **SETUP**. Gain access to position adjustment options by pressing the down ▼ arrow button to highlight **Advanced**, then press ▶ arrow button to select from the following options.

- Highlight **H-Pos**. Navigate using the ◀ ▶ arrow buttons to adjust the position of images displayed from side to side.



- Highlight **Clock**. Navigate using the ◀ ▶ arrow buttons to control the width of the image.



- Highlight **V-Pos**. Navigate using the ◀ ▶ arrow buttons to adjust the position of images displayed up and down.



- Highlight **Phase**. Navigate using the ◀ ▶ arrow buttons to improve focus and image stability.

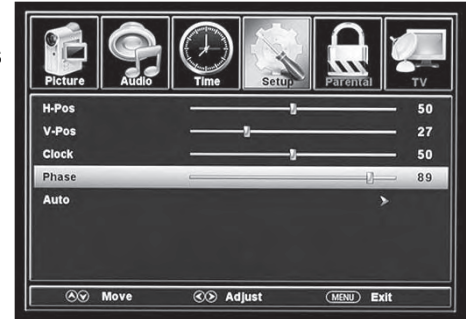

- Highlight **Auto**. Press the ▶ arrow button to automatically adjust the display to the best setting. When prompted, select Yes to confirm.



When prompted, Select "Yes" to confirm.

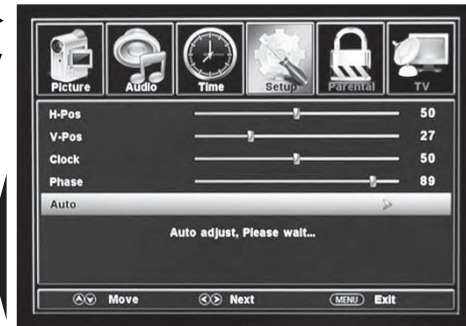

In the **PARENTAL** menu, you may block television and movie programming based on TV ratings and Motion Picture Association guidelines. To gain access and select your preferences within the Parental menu make certain your input is set to TV.

How to Navigate:

Press the **MENU** button on the remote control. Navigate using arrow **◀ ▶** buttons to select **PARENTAL**. Gain access to parental rating options by pressing the down **▼** arrow button to highlight **ENTER PASSWORD**. Enter your 4 digit code (factory default code is "0000") unless previously changed.



- To set parental controls for television programming or DVD movies, press the down/up **▼▲** arrow buttons to highlight **US**. Navigate using the **◀ ▶** buttons to highlight **TV/MPAA** menu.

- To change the password, press **▶** arrow button to display a screen to enter your new password, then confirm again. (not illustrated)

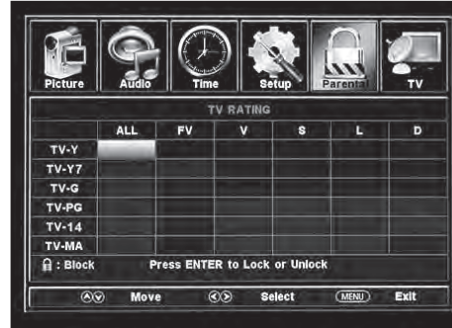

- Highlight **TV**, then press the **▶** arrow button to enter the TV Ratings menu to select your preference.

TV-Y Appropriate for all children
TV-Y7 Appropriate for all children over 7
TV-G General Audience
TV - PG Parental Guidance Suggested
TV - 14 Parents Strongly Cautioned
TV - MA Mature Audience Only

- To make changes to **PARENTAL** controls, highlight **SYSTEM LOCK** then press the **▶** arrow button to **ON**.

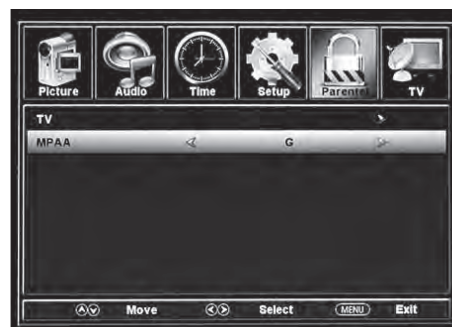

- Highlight **MPAA** then press the **▶** arrow button repeatedly to select your movie rating preference.

G General Audience
PG Parental Guidance Suggested
PG13 Parents Strongly Cautioned
R Restricted
NC17 No One Under 17 Permitted
X Adults Only

NOTE: Features are not available when text is grayed out.

In the **PARENTAL** menu, you may block television and movie programming based on Canadian TV and movie rating guidelines. To gain access and select your preferences within the Parental menu make certain your input is set to **TV**.

How to Navigate:

Press the **MENU** button on the remote control. Navigate using arrow ◀▶ buttons to select **PARENTAL**. Gain access to rating options by pressing the down ▼ arrow button to highlight **ENTER PASSWORD**. Enter your 4 digit code (factory default code is "0000") unless previously changed. See page 24 for information on how to change your password.

- Navigate using down ▼ arrow button to highlight **CANADA ENGLISH** then press the ▶ arrow button repeatedly to select your ratings preference.



E	Appropriate for everyone
C	Appropriate for all children
C8+	Appropriate for everyone 8 years old and up
G	General Audience
PG	Parental Guidance
14+	Appropriate for Children over 14 years old
18+	Mature Audience Only

- Navigate using down ▼ arrow button to highlight **CANADA FRENCH** then press the ▶ arrow button repeatedly to select your ratings preference.



E	Appropriate for everyone
G	General Audience
8 ans+	Appropriate for Children 8 years old and up
13 ans+	Appropriate for Children 13 years old and up
16 ans+	Appropriate for Children 16 years old and up
18 ans+	Mature Audience Only

Note: When adjustments are complete, you may select another menu by pressing the Menu button.

The **TV** menu provides for the setup of your television to receive TV channels, store your favorites, add or skip channels and label them by their call letters. (For antenna and Channel Auto Scan setup, please refer to page 17.)

How to Navigate:

Press the **MENU** button on the remote control. Navigate using arrow ◀▶ buttons to select **TV**. Press the down ▼ button to highlight your preferences.

- Highlight **FAVORITE** to add channels to your Favorites List. Navigate using the ◀▶▼▲ arrow buttons to select channels to be added or deleted from your list. Press **ENTER** to add or delete a channel. A checkmark indicates a channel has been added. You may also display your **FAVORITE** list from the remote control by pressing **FAV**.



- Highlight **ADD/DELETE** to select or skip channels already in memory. Navigate using the ◀▶▼▲ arrow buttons to access the list of available channels. Press **ENTER** to change the channels status. A checkmark indicates a channel has been added.



- Highlight **CHANNEL LABEL** to name or rename a broadcast channel. Navigate using the ▶ arrow button to enter the screen menu to re-label a channel. Use the ▼▲ arrow buttons to spell out each letter, number or character. Use ◀▶ arrow buttons to advance to the next space.

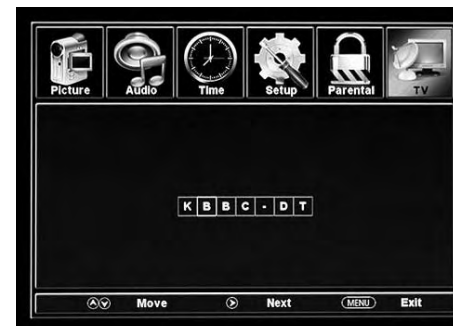

NOTE: The **DTV SIGNAL** is a measurement of signal strength for the current channel viewed.

The **ZOOM** function offers several viewing display options on the 16:9 screen. Press ZOOM to cycle through the following widescreen settings.

Press ZOOM to cycle through the following widescreen settings.

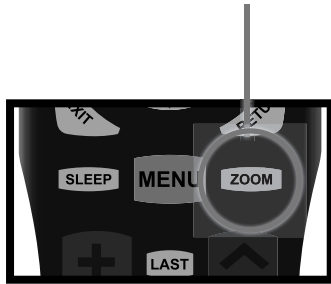

1. NORMAL

Recommended for viewing native widescreen content and undistorted 4:3 images.



2. WIDE

Stretches certain 4:3 content and may reduce the black bars.



3. ZOOM

Stretches the image both vertically and horizontally to fill the screen when viewing widescreen content. The zoom effect will crop images somewhat.



4. CINEMA

When viewing 4:3 content, Cinema mode will fill the entire screen eliminating the side black bars. It may also eliminate or reduce black bars on certain widescreen movies.



Display	LED																		
Size (inch)	23.6" Diagonal																		
Aspect Ratio	16:9																		
Digital Compatibility	480i / 480p / 720p / 1080i / 1080p																		
Resolution	1,920 x 1,080																		
Brightness (cd/m2)	300																		
Dynamic Contrast Ratio	30,000:1																		
Vertical Viewing Angle (degrees)	160°																		
Horizontal Viewing Angle (degrees)	170°																		
Maximum Colors (millions)	16.7M																		
Power Consumption	< 100 Watts																		
Audio Power	2 X 3W																		
Dimension without Pedestal Installed	22.56" (W) x 14.3" (H) x 1.7" (D)																		
Weight without Pedestal	9.25 lbs.																		
Input Connections	<table> <tr> <td>Composite Video</td> <td>(1)</td> </tr> <tr> <td>YPbPr / Audio (L/R)</td> <td>(1)</td> </tr> <tr> <td>HDMI</td> <td>(2)</td> </tr> <tr> <td>RF</td> <td>(1)</td> </tr> <tr> <td>SPDIF Coaxial Digital Output</td> <td>(1)</td> </tr> <tr> <td>PC/VGA</td> <td>(1)</td> </tr> <tr> <td>PC Audio IN</td> <td>(1)</td> </tr> <tr> <td>Headphone Jack (3.5mm)</td> <td>(1)</td> </tr> <tr> <td>USB (For Technician Only)</td> <td>(1)</td> </tr> </table>	Composite Video	(1)	YPbPr / Audio (L/R)	(1)	HDMI	(2)	RF	(1)	SPDIF Coaxial Digital Output	(1)	PC/VGA	(1)	PC Audio IN	(1)	Headphone Jack (3.5mm)	(1)	USB (For Technician Only)	(1)
Composite Video	(1)																		
YPbPr / Audio (L/R)	(1)																		
HDMI	(2)																		
RF	(1)																		
SPDIF Coaxial Digital Output	(1)																		
PC/VGA	(1)																		
PC Audio IN	(1)																		
Headphone Jack (3.5mm)	(1)																		
USB (For Technician Only)	(1)																		

Check for a possible solution to a symptom before contacting a customer service representative.

Symptom	Possible Solutions
Remote codes for satellite/cable box users	<ul style="list-style-type: none"> • 572, 591, 594, 0022, 1397, 11531 • Call your satellite or cable provider to determine codes.
No color	<ul style="list-style-type: none"> • Check the video installation of your external A/V equipment. See pages 9-14.
Cannot receive certain channels through the antenna	<ul style="list-style-type: none"> • Perform Channel Scan to add channels into the TV tuner memory. See page 18. • Readjust your antenna and retry Auto Channel Scan. • Signal from the TV station may be weak in your area.
TV signal blocked on certain channels	<ul style="list-style-type: none"> • Perform Channel Scan to add channels into the TV tuner memory. See page 18. • Check whether the channel was deleted. See page 28. • Check parental control settings. See pages 26, 27. • Restore default settings. See page 23.
Video noise or choppy picture	<ul style="list-style-type: none"> • Readjust antenna. Keep TV away from noise sources, neon lights, and microwave appliances.
No sound	<ul style="list-style-type: none"> • Check that connected audio cables are completely inserted. • Verify you have selected the correct audio source from your amplifier. See page 15. • Mute function may be enabled, press mute on the remote.
Black box on screen	<ul style="list-style-type: none"> • The "Text" option is enabled and no text is available. • Press the CCD button on the remote control to turn off.
No power	<ul style="list-style-type: none"> • Batteries in the remote control may need replacing. • Re-attach AC plug to wall outlet.
No picture	<ul style="list-style-type: none"> • Digital TV channel signal maybe weak, try another channel. • Press INPUT button to verify the desired input selected. • Re-connect the antenna or cable wiring. • Restore default settings. See page 23.
Remote control does not function	<ul style="list-style-type: none"> • Replace batteries with new ones. • Check that battery polarity is correct. • Point remote directly at the TV's IR receiver. See page 6.

A					
AC Power Plug	9				
Add/Delete channels	26				
Advanced mode	23				
Advanced selection	22				
Air/Cable	10, 18				
Antenna installation	10				
Arrow buttons	7				
Audio Setup & Adj.	7, 15, 21				
Audio Language	21				
B					
Balance Adjustment	21				
Bass Adjustment	21				
Batteries	6, 31				
Brightness Adjustment	20				
C					
CCD (Closed Caption)	7, 24				
Cable Installation	10, 18				
Canadian Ratings	27				
Channel Up/Down	7-8				
Channel Auto Scan	18				
Channel Label	28				
Channel List	7				
Clock	22, 25				
Cinema Zoom	29				
Coaxial Digital Output	15				
Color Adjustment	20				
Color Temperature	20				
Composite Input	13				
Component Input	12				
Computer Connection	14, 25				
Contrast Adjustment	20				
D					
Dash (-)	7				
Daylight Savings Time	22				
Default Settings	23				
Digital Cable	10				
Digital Set Top Box	10				
Digital Audio	15				
Display	7				
Display Modes for PC	14				
E					
Exit	7				
F					
Favorite Channels	7, 28				
G					
Guide	7				
H					
HDMI Inputs	11				
Headphone	9				
Home Theater	15				
I					
IR Receiver	6, 8				
Input	7-8, 11-14				
L					
Languages	19, 23				
Last	7				
LED light	8				
M					
Master Power	8-9				
Menu	7-8, 16-28				
MTS	7, 21				
Motion Technology 120Hz	5				
Mute	7				
Movie Ratings	26-27				
Movie Mode	18				
N					
Normal Zoom	29				
Noise Reduction	23				
Number Buttons	7				
P					
Parental Control	26-27				
Password	26-27				
Pedestal Stand Removal	9				
PC	9, 14, 25				
PCM	15				
Phase	25				
Picture Modes	7, 20				
Power	7-9				
R					
RAW	15				
Ratings (TV, Movie)	26-27				
Remote Control	6-7				
RF Input	9, 10				
Restore Default setting	23				
Reset Password	26				
Roof Antenna	10				
S					
Satellite Installation	10-13				
Sleep Timer	7, 22				
Sharpness adjustment	20				
SPDIF Type	9, 15, 21				
Standby	7-8				
Speakers (built-in)	15, 21				
T					
Time Zone	22				
Tint Adjustment	20				
Treble Adjustment	21				
Transparency	23				
Surround	21				
V					
Video Adjustment	20				
Volume Adjustment	7-8				
VGA Installation & Adj.	9, 14, 25				
W					
Wall Mounting	9				
Wide Zoom	29				
XYZ					
XVS (Black detail enhancement)	23				
YPbPr	9, 12				
Zoom Modes	7, 23, 29				

**Limited North American Warranty
Tmax Digital Inc.
LE2412**

For peace of mind and valuable services, please take a moment to register your product at www.tmaxdigital.com

Tmax Digital Inc. expresses the following non-transferable and limited warranty on a new Apex Digital LE2412 purchased from an authorized Apex Digital® U.S. retailer. Retain the original bill of sale for proof of purchase.

Limited One (1) Year Warranty

TMAX warrants the parts in this product against defects in material or workmanship for a period of one (1) year from the date of original purchase. During this period, TMAX will replace a defective part with a new or refurbished part without charge to you. TMAX also warrants it will be responsible for labor charges for a period of one (1) year from the date of original purchase. It is the responsibility of the consumer to retain original packaging or provide like packaging in order to facilitate the warranty process. TMAX will incur no liability whatsoever to provide packaging for warranty items. Upon receipt of the warranty item, should the product be damaged due to insufficient packaging, the warranty may be voided. The consumer is responsible for the transportation cost and insurance charges (if applicable) to an authorized Service Center or TMAX. You must receive a return authorization number before taking or sending a unit in for warranty service. Service that is provided is warranted for the duration of the original warranty or 45 days.

Your Responsibility

The warranty is subject to the following conditions: You must retain the original bill of sale (or a photocopy) to provide proof of purchase even if the product was received as a gift. You must call the provided phone number for an assessment of the problem. No warranty service shall be provided until a claim or return authorization (RMA#) is provided to you. If the screen size is below 32", attach or print the RMA# to the shipping carton along with a copy of the bill of sale and ship back to the address provided to you. It is your responsibility to retain packaging or provide like packaging in order to ship and facilitate the warranty process on televisions. TMAX will incur no liability whatsoever to provide packaging. You are responsible for all tariffs and taxes imposed to ship or receive warranty replacement units to and from the U.S. over the Canadian border. Labor service charges for TV installation, setup, adjustment of consumer controls and installation or repair of any type of antenna or cable systems are not covered by this warranty. Reception problems caused by inadequate antenna or cable systems are your responsibility. Warranty extends only to defects in materials or workmanship as limited above and do not extend to any other products or parts that have been lost, mistakenly discarded, damaged by misuse, accident, neglect, acts of God such as lightning, or voltage surges in the home, improper maintenance or use in violation of instructions, or product that has been modified or had the serial number removed or altered. Warranty does not cover cosmetic or missing/lost accessories.

How to Obtain Warranty Service

If after following the user manual, quick start and troubleshooting guide, should you find it necessary to contact Customer Service directly, call 1-877-833-1888 daily from 7am-9pm (Central Time). You will be instructed on how your claim will be processed. Have pertinent information available including proof of purchase details and a full understanding of the issue.

Limitations

The flat panel display is an innovative device that is manufactured to precise tolerances with active performing pixels of at least 99.99%. As such, it is NOT a malfunction to view multiple non-performing pixels on your screen. All warranties implied by state law are expressly limited to the duration of the limited warranties set forth above with the exception of warranties implied by state law as hereby limited, the foregoing warranty is exclusive and in lieu of all other warranties, guarantees, agreements, etc., with respect to repair or replacement of any parts. TMAX shall not be liable for consequential or incidental damage. This warranty gives you specific rights and you may also have rights that may vary from state to state. Some states don't allow limitations on warranty duration, exclusions or limitation of incidental or consequential damages, so the above may not apply.