

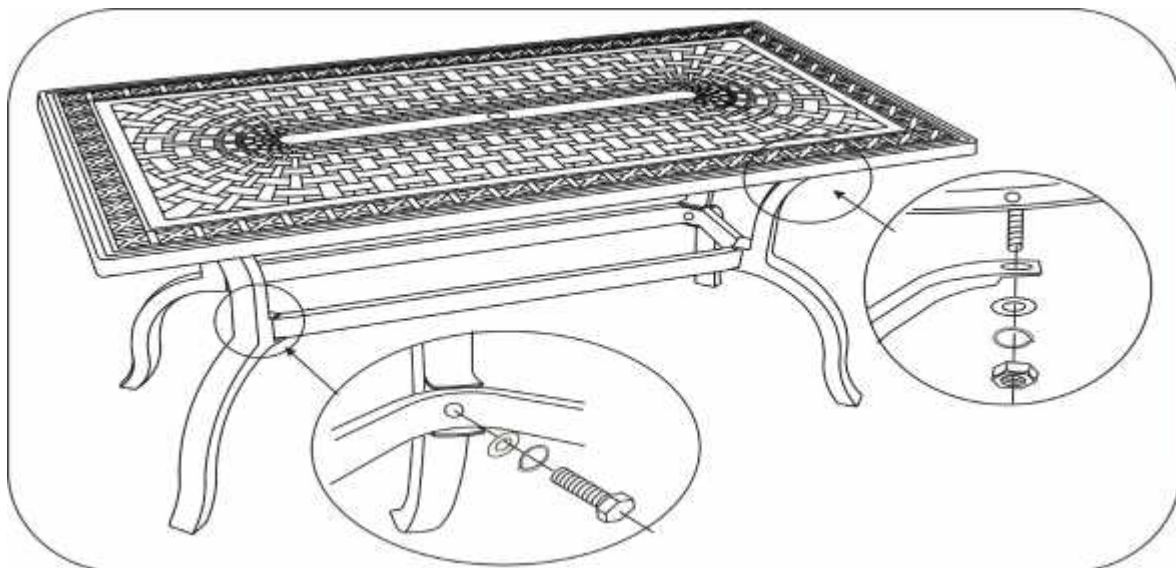









Assembly Instruction

1. Identify all parts packed in carton against the parts list. Remove all protective material carefully and avoid cutting the surface of the furniture while removing the bubble wrap.
2. Put the table top upside down a flat surface. Attach the legs with Big Bolts, washers and lock washers, don't tighten at this time.
3. Connect the legs with the Center Rings, tighten with Small Bolts, washers, lock washers. Progressively tighten all the bolts until secure.
4. Turn the table on its legs, you can adjust foot plugs to level table if needed.



Parts List	Description	Quantity
	Table Top	1
	Table Leg	4
	Center Ring	1
	Stud	4
	Bolt	4
	Big Washer	4
	Small Washer	4
	Big Lock Washer	4
	Small Lock Washer	4
	Locker Nut	4

Warning: Do not force components and over tighten during assembly.