

HOME DECORATORS COLLECTION

BF-20903 OXFORD 3 DRAWER FILE CONSOLE

INV#52200

ASSEMBLY INSTRUCTIONS

Made In China

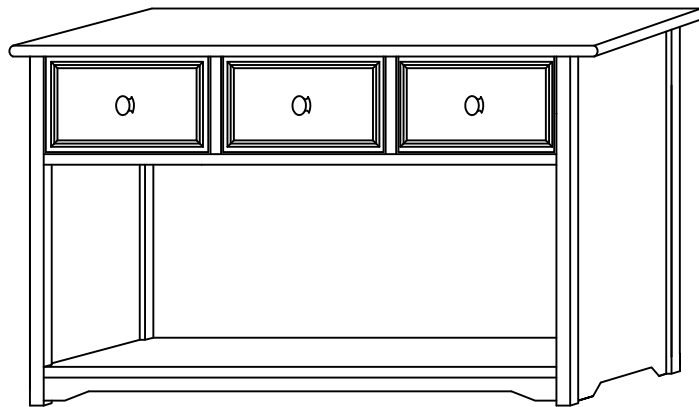







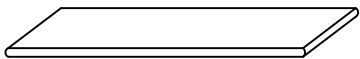
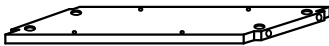
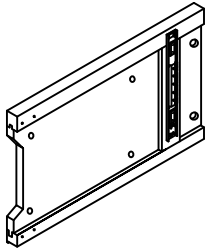
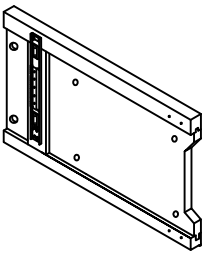
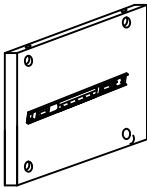
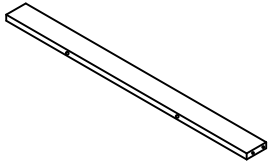
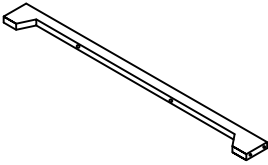
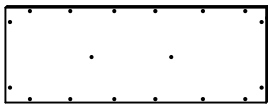
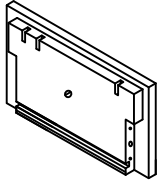
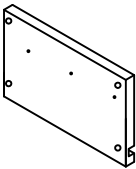
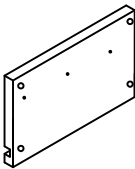
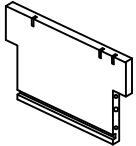

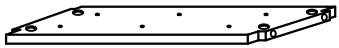
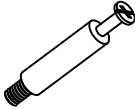

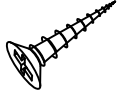
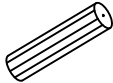
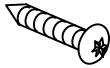
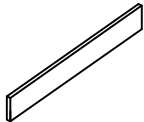

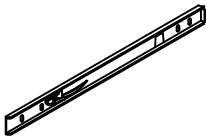
Thank you for purchasing this quality product. Be sure to check all packing material carefully for small parts, which may have come loose inside the carton during shipment. Count all parts and material hardware, then compare with parts list to be sure all parts are present. If any parts are missing or damaged, phone, fax, or mail to our Customer Service Department for efficient and speedy service. Please indicate the model number and code letter of part(s) needed.

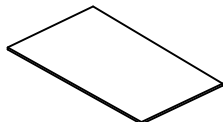
IMPORTANT NOTE: Follow instructions listed below in proper sequence as numbered to assure fast, easy and correct assembly.

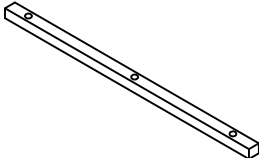
PARTS LIST

<p>A</p>  <p>TOP PANEL-1PC</p>	<p>B</p>  <p>BOTTOM PANEL-1PC</p>	<p>C</p>  <p>LEFT SIDE PANEL-1PC</p>
<p>D</p>  <p>RIGHT SIDE PANEL-1PC</p>	<p>E</p>  <p>STAND PANELS-2PCS</p>	<p>F</p>  <p>BACK LOW PANEL-1PC</p>
<p>F1</p>  <p>FRONT LOW PANEL-1PC</p>	<p>G</p>  <p>BACK PANEL-1PC</p>	<p>H</p>  <p>DRAWER PANEL FRONTS-3PCS</p>
<p>I</p>  <p>RIGHT DRAWER PANEL SIDES-3PCS</p>	<p>I1</p>  <p>LEFT DRAWER PANEL SIDES-3PCS</p>	<p>J</p>  <p>DRAWER PANEL BACKS-3PCS</p>

<p>K</p>  <p>ACROSS PANEL-1PC</p>	<p>L</p>  <p>CAM-BOLTS-20PCS</p>	<p>M</p>  <p>CAM-LOCKS-20PCS</p>	
<p>N</p> <p>6mm × 1"</p>  <p>SCREWS-24PCS</p>	<p>N1</p> <p>8mm × 1"</p>  <p>SCREWS-10PCS</p>	<p>O</p>  <p>DOWELS-20PCS</p>	
<p>P</p> <p>6mm × 1/2"</p>  <p>SCREWS-22PCS</p>	<p>R</p>  <p>FILE HANGERS-6PCS</p>	<p>S</p>  <p>CAM-TOOL-1PC</p>	
<p>T</p>  <p>INNER SLIDES-6PCS</p>	<p>U</p> <p>6mm × 3/8"</p>  <p>SCREWS-18PCS</p>	<p>V</p>  <p>DRAWER PANEL BOTTOMS-3PCS</p>	
<p>Y</p> <p>8mm × 5/8"</p>  <p>SCREWS-3PCS</p>	<p>Z</p>  <p>KNOBS-3PCS</p>	<p>A1</p>  <p>ACROSS PANELS-2PCS</p>	
<p>W1</p> <p>fall down prevention</p>  <p>HOOKS-2PCS</p>	<p>X1</p> <p>fall down prevention</p> <p>6mm × 1"</p>  <p>SCREWS-2PCS</p>	<p>Y1</p> <p>fall down prevention</p>  <p>GECKOS-2PCS</p>	<p>Z1</p> <p>fall down prevention</p> <p>7mm × 7/8"</p>  <p>SCREWS-2PCS</p>

NOTE: THE SURFACE WITH THE STICKER IS THE BACK SIDE.

NOTE: • UPON OPENING, THOROUGHLY CLEAN ALL WOODS SURFACES TO REMOVE DUST AND DIRT THAT MAY HAVE SETTLED ONTO FINISH DURING SHIPMENT. IN ORDER TO PREVENT DAMAGE DURING ASSEMBLY, PLEASE ASSEMBLE THIS ITEM WITH AT LEAST TWO PEOPLE.

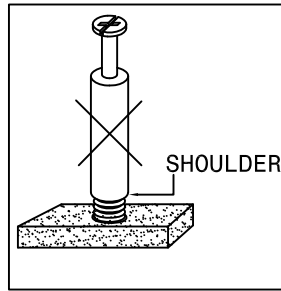
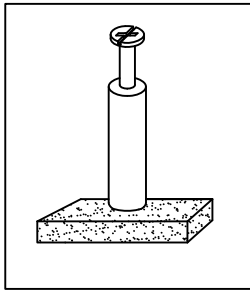

NOTE: TURN THE CAM-BOLT SCREWS UNTIL THEY ARE TIGHT, THE SHOULDER SHOULD BE AGAINST THE SURFACE OF THE PART.

HOW TO USE THE CAM-TOOL

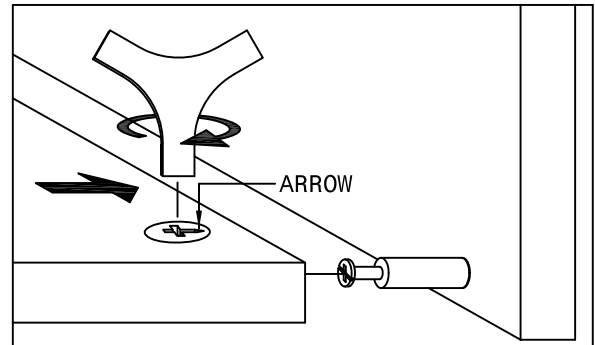
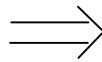
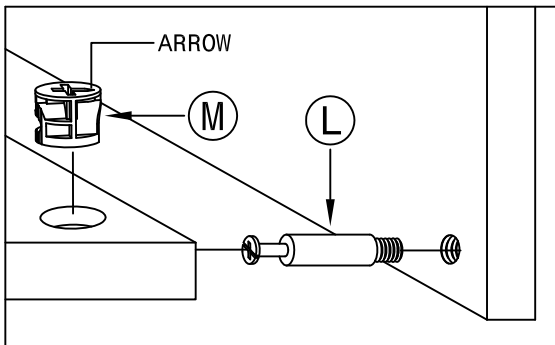

NOTE: • THE ARROWS ON THE HIDDEN CAM-LOCKS SHOULD POINT TO THE CAM-BOLTS

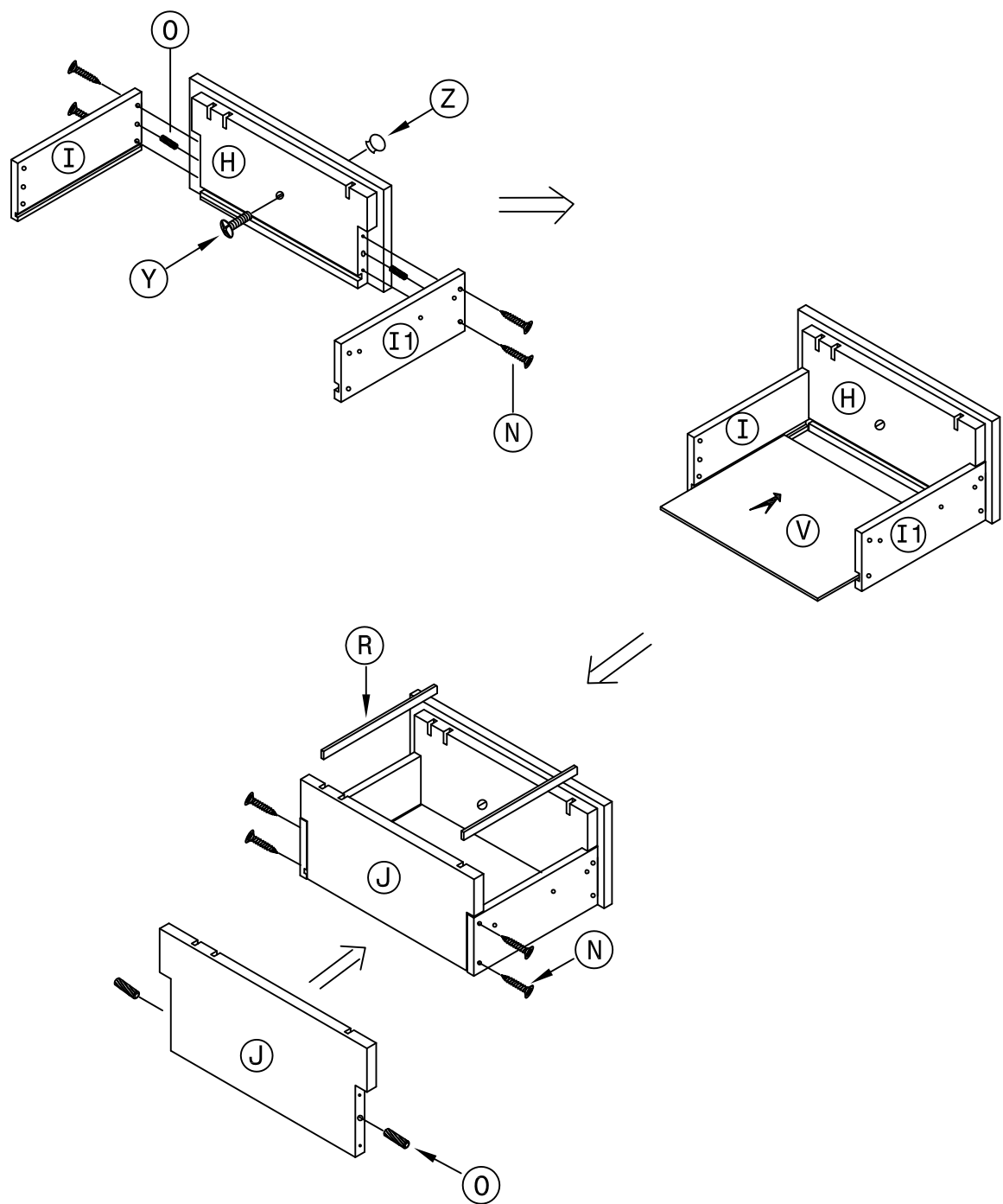

1). ASSEMBLE THE DRAWER.

- INSERT DOWELS(O) INTO THE HOLES IN THE PANEL(H) AND ATTACH SIDE PANEL(I/I1) USING SCREWS(N) .
- ATTACH THE KNOB(Z) TO FRONT DRAWER PANEL(H) USING SCREWS(Y) .
- INSERT BOTTOM DRAWER PANEL(V) INTO THE SLOT IN THE SIDE DRAWER PANEL(I/I1) .
- INSERT THE DOWELS(O) INTO THE HOLES IN THE BACK DRAWER PANEL(J) AND ATTACH USING SCREWS(N) .
- INSERT THE FILE HANGER(R) INTO THE CUT-OUT OF DRAWER PANEL FRONT & BACK.

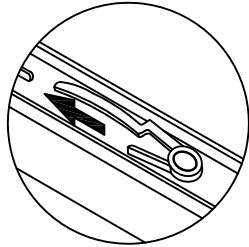

ARROW FACES DRAWER FRONT

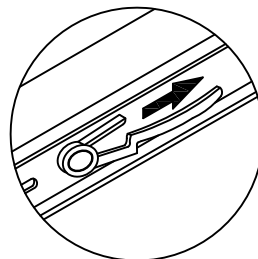
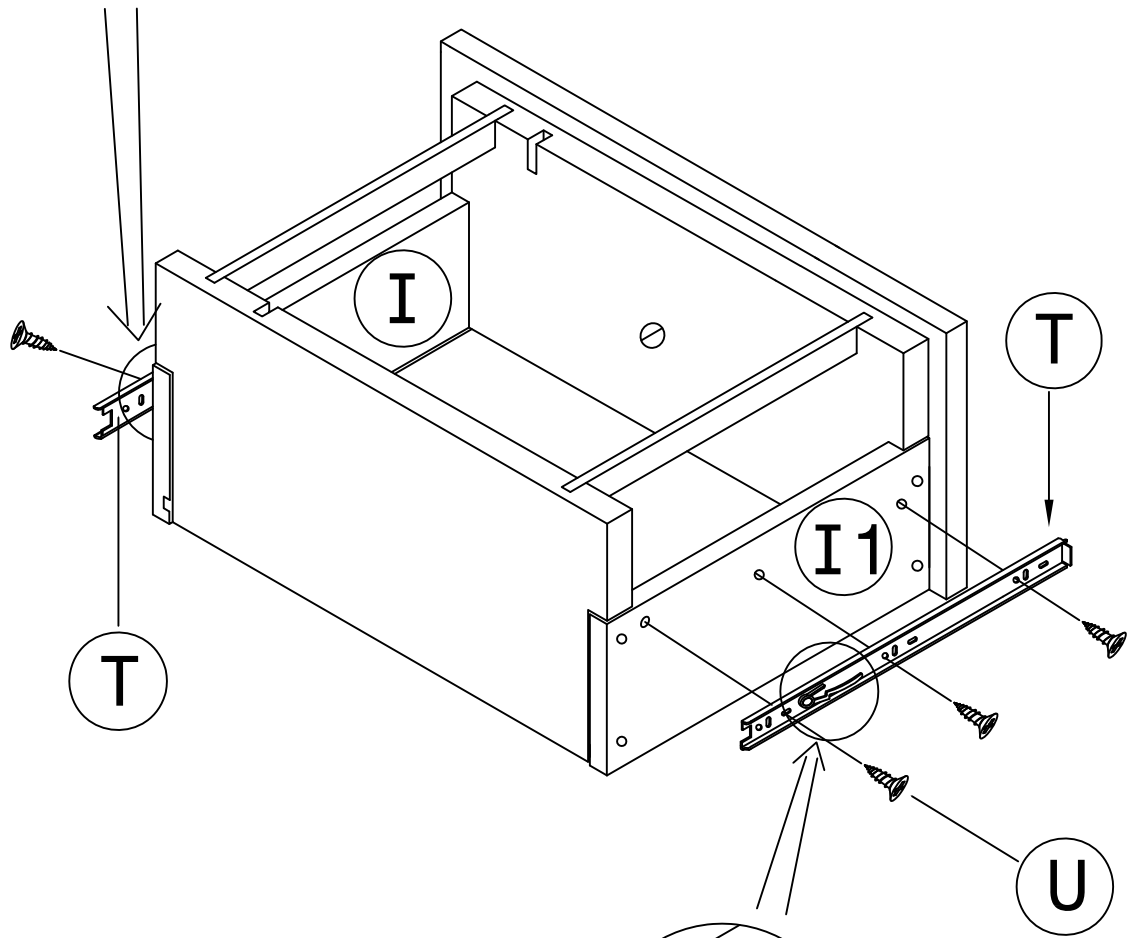

ARROW FACES DRAWER FRONT

2). ASSEMBLE THE INNER SLIDES(T).

- ATTACH INNER SLIDES(T) TO DRAWER PANEL SIDE(I/I1) USING SCREWS(U).

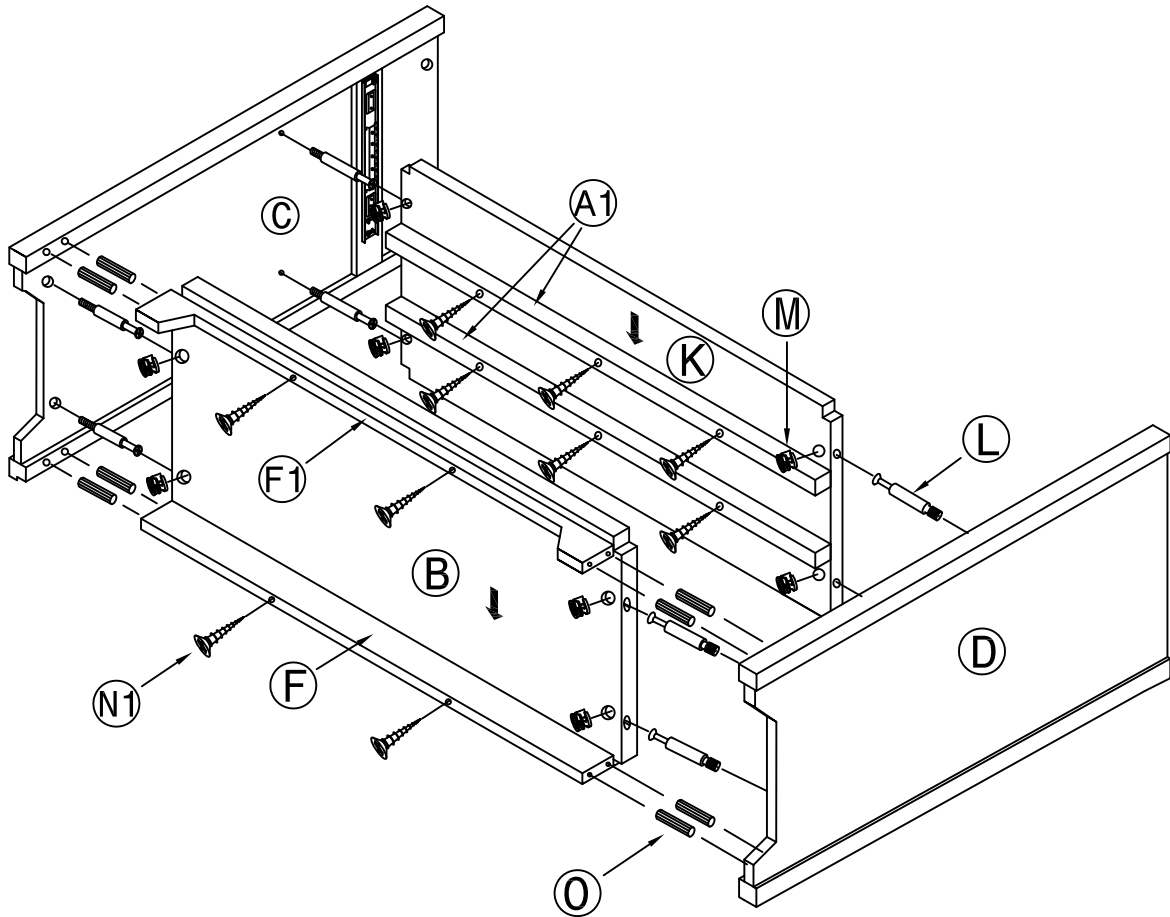

3) . ASSEMBLE SIDE PANEL(C/D) .

- ATTACH THE FRONT/BACK LOW PANEL(F1/F) TO BOTTOM PANEL(B) USING 4 SCREWS(N1) .
- INSERT THE 8 DOWELS(O) IN DESIGNATED HOLES ON FRONT/BACK LOW PANEL(F1/F) .
- ROTATE THE 8 CAM-BOLTS(L) INTO THE HOLES IN THE SIDE PANEL(C/D) .
- PLACE CAM-BOLTS(L) INTO THE HOLES IN PANEL(B/K) AND ATTACH USING 8 CAM-LOCKS(M) .
- ATTACH THE 2 ACROSS PANELS(A1) TO ACROSS PANEL(K) USING 6 SCREWS(N1) .

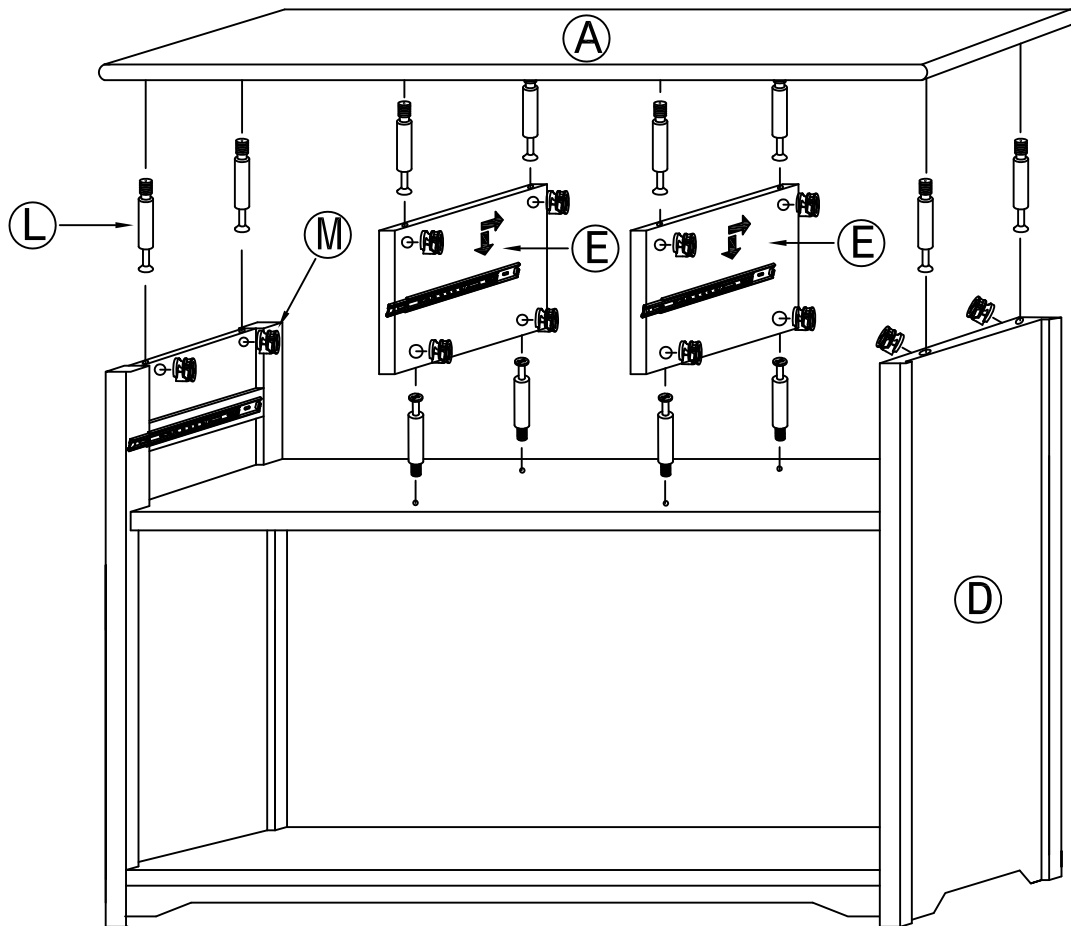

4) . ASSEMBLE THE TOP PANEL (A) .

- ROTATE THE 12 CAM-BOLTS(L) INTO THE HOLES IN THE TOP PANEL(A) AND ACROSS PANEL(K) .
- PLACE CAM-BOLTS(L) INTO THE HOLES IN THE PANEL(C/D/E) AND ATTACH USING 12 CAM-LOCKS(M) .

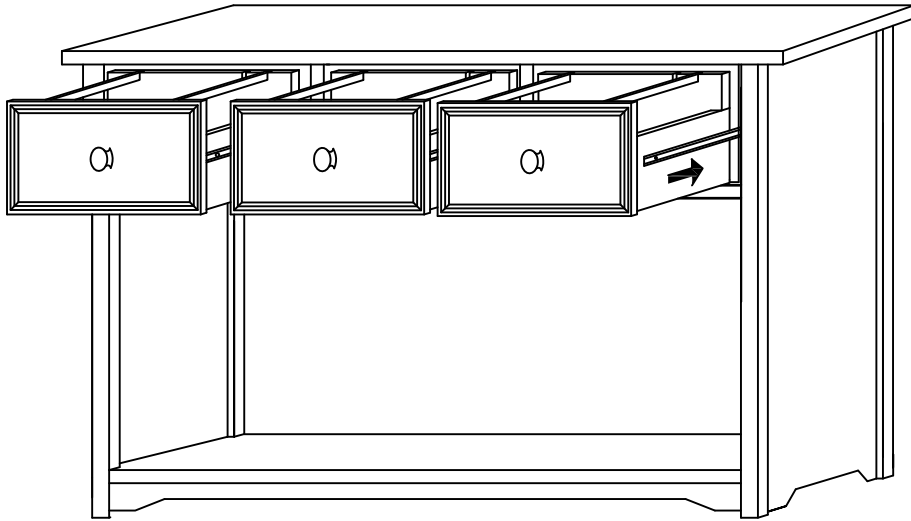

5) . ASSEMBLE THE DRAWERS.

- SLIDE THE 3 DRAWER INNER SLIDES INTO THE OUTER SLIDES.

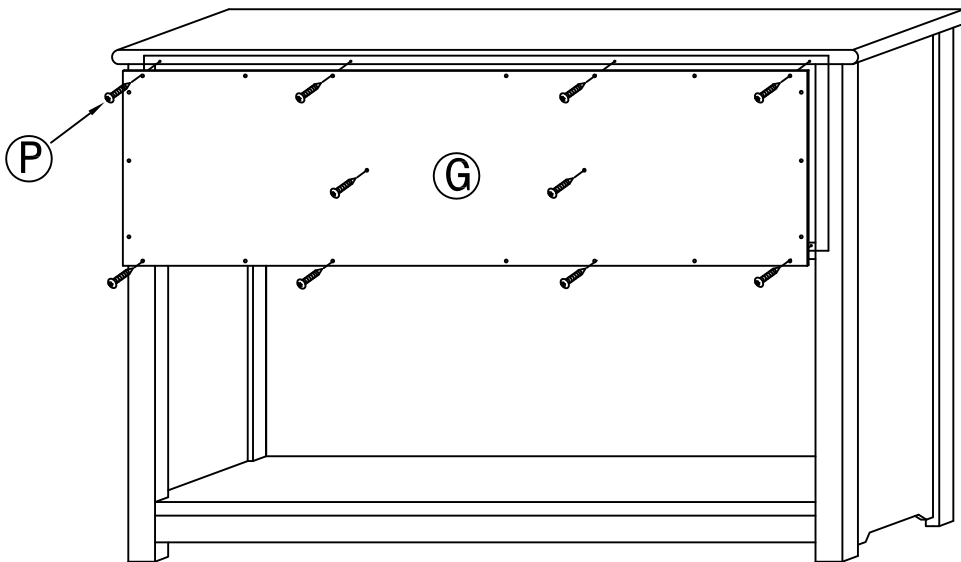

6) . ASSEMBLE THE BACK PANEL (G) .

- ATTACH THE BACK PANEL (G) TO TOP/SIDE/ACROSS/STAND PANEL USING SCREWS (P) .

- I ● ATTACH 2 HOOKS(W1) USING 2 SCREWS(X1) IN THE
PREDRILLED HOLES OF REAR TOP PANEL.

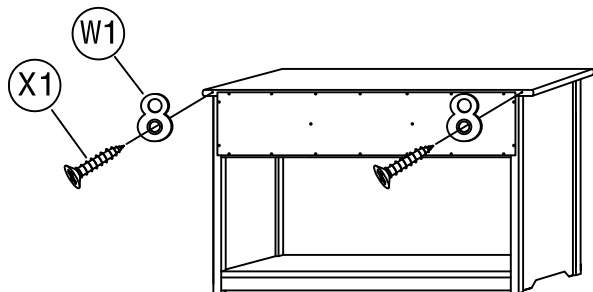

- II ● DRILLING TWO HOLES INTO WALL, PLEASE REFER TO TOP PANEL'S HOLE DISTANCE AND HEIGHT.
● PUT 2 GECKOS(Y1) INTO HOLES IN WALL AND ROTATE 2 SCREWS(Z1) INTO GECKOS(Y1).

