

ProLED High Lumen HID Retrofit Series



Features

- Base up or base down orientation
- Rated for Enclosed Fixtures
- 4000K and 5000K color temperature
- 360° beam angle
- UL Listed for Wet locations
- IP64 Rated for dust protection
- Ballast Bypass
- EX39 base
- Replaces 250W-600W MH or HPS
- 50,000 Hour Rated Lifetime
- 5 Year Warranty
- Safety Cable included

The ProLED High Lumen HID Retrofit Series ballast bypass lamps are an easy to install LED solution for post top and high/low bay fixtures. These ballast bypass lamps offer energy-efficient replacement for 320W to 600W traditional luminaires. This lamp is enclosed fixture rated, IP64 and backed with a Halco 5 year warranty. They are available in 4000K and 5000K color temperatures.

Applications

- Pre-existing HID Post Top Luminaires
- Pre-existing HID High/Low Bay Luminaires

Ordering Information

Ordering Code	Product Number	Wattage	CCT	Base
84106	HID80/840/MV2/EX39/LED	80	4000K	EX39
84108	HID100/840/MV2/EX39/LED	100	4000K	EX39
84110	HID120/840/MV2/EX39/LED	120	4000K	EX39
84107	HID80/850/MV2/EX39/LED	80	5000K	EX39
84109	HID100/850/MV2/EX39/LED	100	5000K	EX39
84111	HID120/850/MV2/EX39/LED	120	5000K	EX39

Example: HID80/840/MV2/EX39/LED

HOUSING	WATTAGE	CRI	CCT	MODEL	BASE	TYPE
HID	80	8	40	MV2	EX39	LED
	80 100 120	8=82	*40=4000K 50=5000K	MV2	EX39	LED

*4000K made to order. For more information and lead times please contact your Customer Care Specialist.

Product Specification

Rated Wattage	80	100	120
Rated Lumen Output	10,800	13,500	16,200
Efficacy	>135 LPW		
Energy Savings	320W MH/HPS replacement equating to an approximate 75% energy savings	400W MH/HPS replacement equating to an approximate 75% energy savings	600W MH/HPS replacement equating to an approximate 75% energy savings
*L70 Useful Lifetime	50000hrs		
L70 Seller	Maintenance and relamping costs reduced dramatically due to high L70 life time rating		
Voltage Range	120 - 277VAC		
Base Type	EX39		
CCT	4000K, 5000K		
CRI	82		
Beam Angle	360°		
Surge Protection	4kV		
Warranty	5 Year Standard Halco Warranty		
Operating Temperature	- 40°F to 122°F		
Power Factor	>0.9		
**IP Rating	IP64		
LED Quantity	234	280	336
Qualifications	DLC Standard, UL, RoHS		
Product Weight (lbs)	3.5	3.6	3.9
Dimensions (in.)	10.16" x 5.65"	10.51" x 5.65"	11.30" x 5.65"

*Useful Life is defined as the point in time at which the lamp will maintain at least 70% of its initial lumens. The lamp will continue to operate past this point at decreased light levels. ** Check the latest update at www.DesignLights.org for listed product catalog numbers. All versions may not be listed. ***IP64 - Rated as 'Dust Tight' and 'Splash' protected

Dimensions

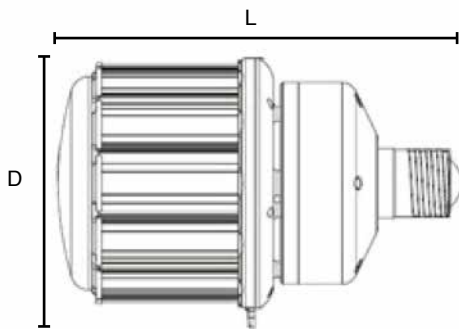

Watt	DIMENSIONS	Weight
80W	L-10.16" x D-5.65"	3.5
100W	L-10.51" x D-5.65"	3.6
120W	L-11.30" x D-5.65"	3.9

Photometrics

Polar Candela
80W ISO FC_15ft

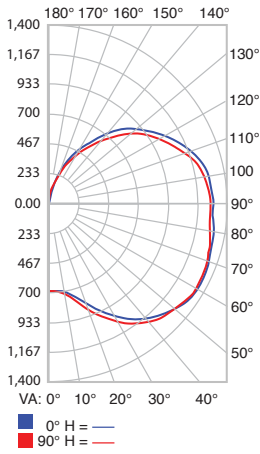

ISO Footcandle plot
80W ISO FC_15ft

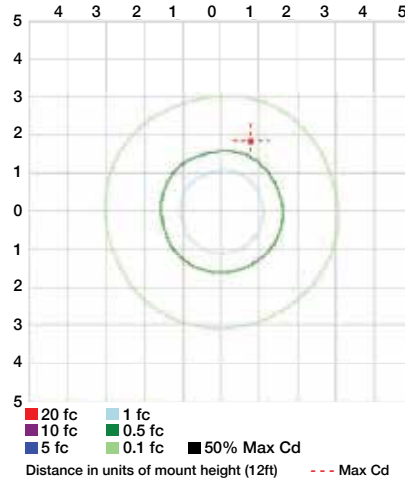

ZONAL LUMEN SUMMARY
ZONE LUMENS % LUMINAIRE

Zone	Lumens	% Luminaire	% Total
0-30	738.4	5.5%	5.5%
0-40	1,452.5	10.7%	10.7%
0-60	3,615.2	26.7%	26.7%
60-90	4,123.0	30.5%	30.4%
70-100	4,186.5	30.9%	30.9%
90-120	3,790.2	28%	28%
0-90	7,738.1	57.2%	57.1%
90-180	5,802.1	42.9%	42.9%
0-180	13,540.2	100%	100%

LUMENS PER ZONE
ZONE LUMENS % TOTAL ZONE LUMENS % TOTAL

Zone	Lumens	% Total Zone	Zone	Lumens	% Total
0-10	68.0	0.5%	90-100	1,390.9	10.3%
10-20	225.3	1.7%	100-110	1,295.0	9.6%
20-30	445.1	3.3%	110-120	1,104.3	8.2%
30-40	714.1	5.3%	120-130	868.0	6.4%
40-50	976.0	7.2%	130-140	608.8	4.5%
50-60	1,186.7	8.8%	140-150	353.2	2.6%
60-70	1,327.4	9.8%	150-160	149.1	1.1%
70-80	1,392.0	10.3%	160-170	31.4	0.2%
80-90	1,403.6	10.4%	170-180	1.3	0%

Polar Candela
100W ISO FC_15ft

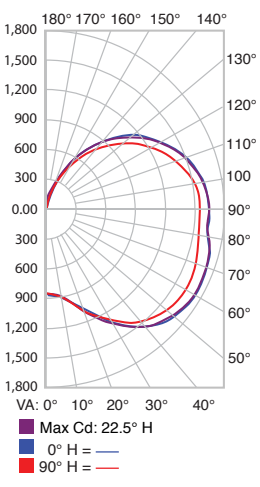

ISO Footcandle plot
100W ISO FC_15ft

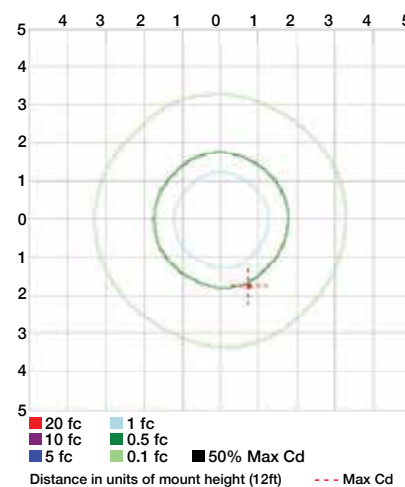

ZONAL LUMEN SUMMARY
ZONE LUMENS % LUMINAIRE

Zone	Lumens	% Luminaire	% Total
0-30	916.6	5.6%	5.6%
0-40	1,796.6	10.9%	10.9%
0-60	4,452.0	27.1%	27.1%
60-90	5,002.1	30.4%	30.4%
70-100	5,049.1	30.7%	30.7%
90-120	4,556.4	27.7%	27.7%
0-90	9,454.1	57.5%	57.5%
90-180	6,978.9	42.5%	42.5%
0-180	16,433.0	100%	100%

LUMENS PER ZONE
ZONE LUMENS % TOTAL ZONE LUMENS % TOTAL

Zone	Lumens	% Total Zone	Zone	Lumens	% Total
0-10	84.2	0.5%	90-100	1,672.9	10.2%
10-20	280.0	1.7%	100-110	1,555.7	9.5%
20-30	552.4	3.4%	110-120	1,327.8	8.1%
30-40	880.0	5.4%	120-130	1,041.5	6.3%
40-50	1,197.9	7.3%	130-140	731.5	4.5%
50-60	1,457.5	8.9%	140-150	425.4	2.6%
60-70	1,625.8	9.9%	150-160	182.7	1.1%
70-80	1,686.2	10.3%	160-170	39.6	0.2%
80-90	1,690.1	10.3%	170-180	1.7	0%

Polar Candela
120W ISO FC_15ft

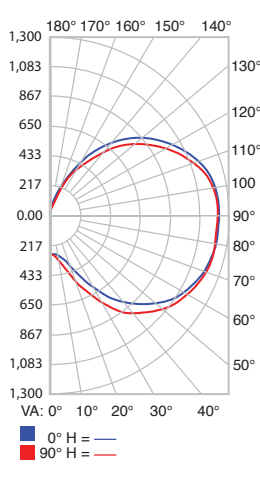

ISO Footcandle plot
120W ISO FC_15ft

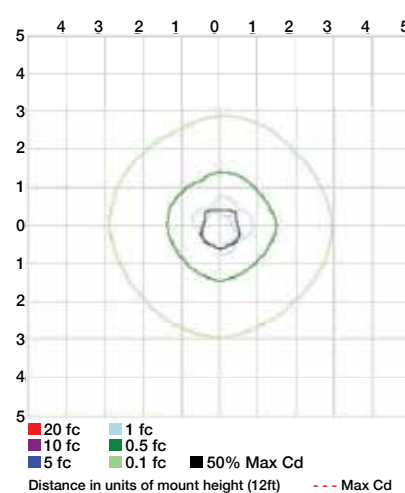

ZONAL LUMEN SUMMARY
ZONE LUMENS % LUMINAIRE

Zone	Lumens	% Luminaire	% Total
0-30	396.6	3.7%	3.7%
0-40	854.8	7.9%	7.9%
0-60	2,419.4	22.3%	22.3%
60-90	3,436.9	31.6%	31.6%
70-100	3,583.8	33%	33%
90-120	3,285.9	30.3%	30.3%
0-90	5,856.3	53.9%	53.9%
90-180	5,004.0	46.1%	46.1%
0-180	10,860.3	100%	100%

LUMENS PER ZONE
ZONE LUMENS % TOTAL ZONE LUMENS % TOTAL

Zone	Lumens	% Total Zone	Zone	Lumens	% Total
0-10	29.7	0.3%	90-100	1,205.7	11.1%
10-20	111.0	1.0%	100-110	1,124.3	10.4%
20-30	255.8	2.4%	110-120	955.9	8.8%
30-40	458.2	4.2%	120-130	746.5	6.9%
40-50	677.6	6.2%	130-140	520.7	4.8%
50-60	887.0	8.2%	140-150	297.4	2.7%
60-70	1,058.7	9.7%	150-160	125.3	1.2%
70-80	1,167.6	10.8%	160-170	27.3	0.3%
80-90	1,210.5	11.1%	170-180	1.1	0%