

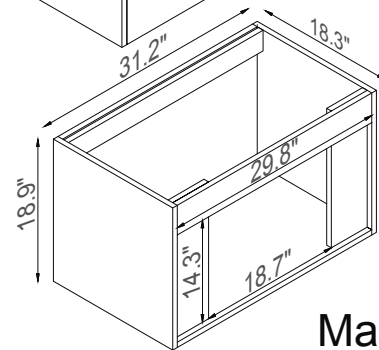

Streamline

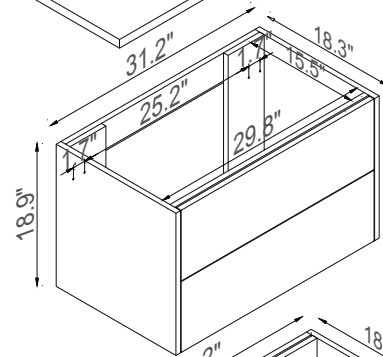
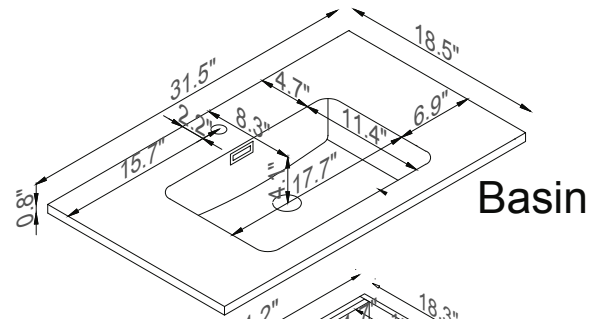

K1500-161-32-51