

Single Lever Basin Faucet:

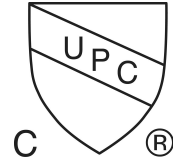

Model No.:YPG302

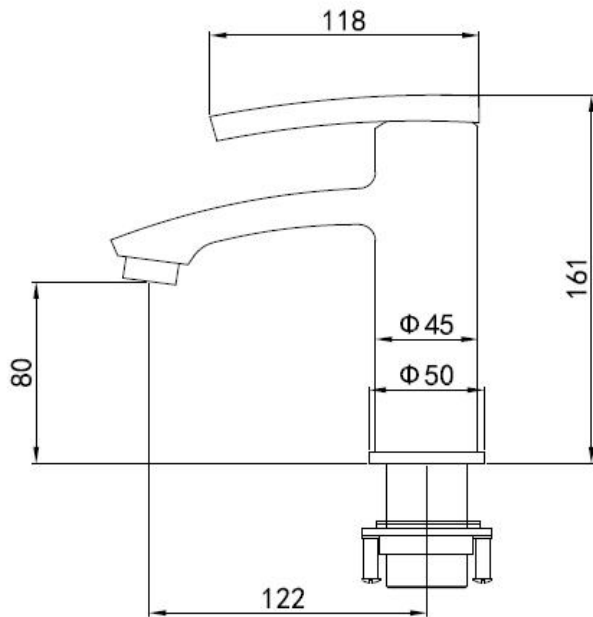

ALL SIZE IN MM

Features:

- 1.Material: low lead brass
- 2.Handle:zinc
- 3.Aetator:ABS
- 4.Valve: ceramic valve
- 5.100% pressure system tested.
- 6.CUPC approve

Flow Rate:

1.2 GPM@ 60PSI

Available Finishes:

Chrome

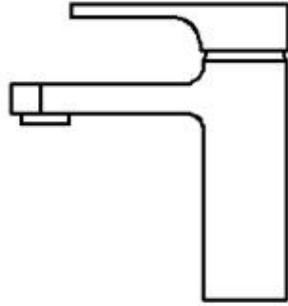

Lavatory Faucet Installation

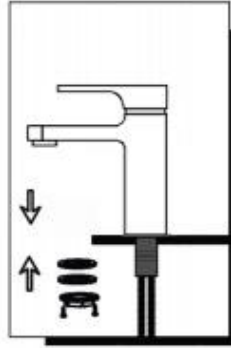

1. Install faucet through center hole, assembly washer and metal washer onto faucet, and tighten with lock nut.

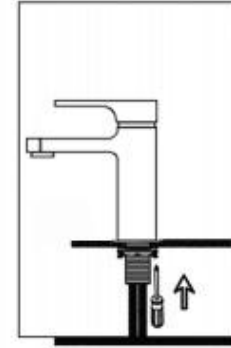

2. Tighten by screwing two screws if needed.

INSTALLATION MANUAL

Tools You Will Need:



Plumber's putty



Pipe tape



Philips Screwdriver



Pliers



Adjustable wrench

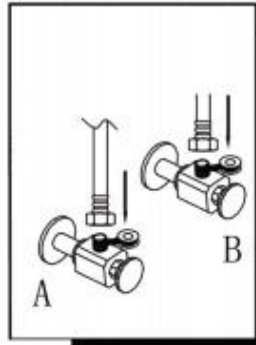

3. Attach two flexible hoses to water supply.

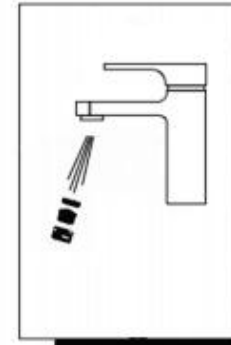

4. After installing faucet, remove aerator assembly and open the hot and cold water supplies. Check for leaks. Turn on faucet handle for one minute to flush debris from faucet. Close the handle and re-assemble the aerator.