

USG  
Tile &  
Flooring  
Solutions

**USG DUROCK™ BRAND  
SHOWER SYSTEM  
PRODUCT CATALOG**

**A SUPERIOR SHOWER SYSTEM  
FROM A NAME YOU TRUST**

**USG**   
IT'S YOUR WORLD. BUILD IT.™



# INNOVATION THAT STARTS FROM WITHIN

An exceptionally engineered system for tiled shower installations, the USG Durock™ Brand Shower System is a fully bonded waterproofing system, designed to control moisture independently of the tile covering while creating a solid base for a long-lasting shower. And because it comes from a manufacturer with a reputation for delivering products and systems designed to outshine the competition, you can trust that it will deliver performance superior to other systems on the market.

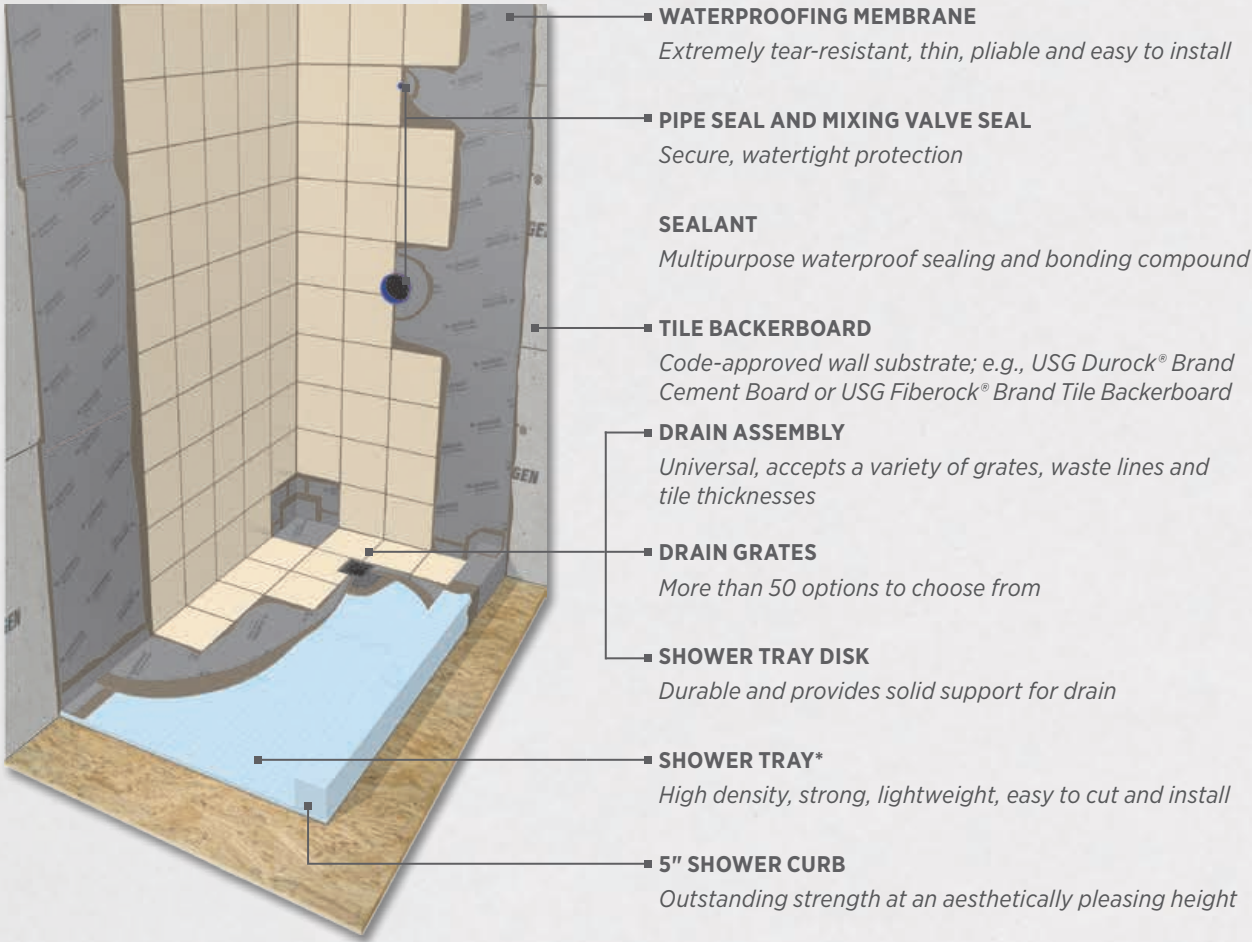

## \*USG DUROCK™ BRAND CUSTOM SHOWER TRAY PROGRAM

We now offer a program that helps you design and install near limitless configurations of shower shapes and sizes. The new custom shower trays are backed by the USG Durock® Brand and work perfectly with the USG Durock™ Shower System.

Learn more at [www.durockshowersystem.com](http://www.durockshowersystem.com).

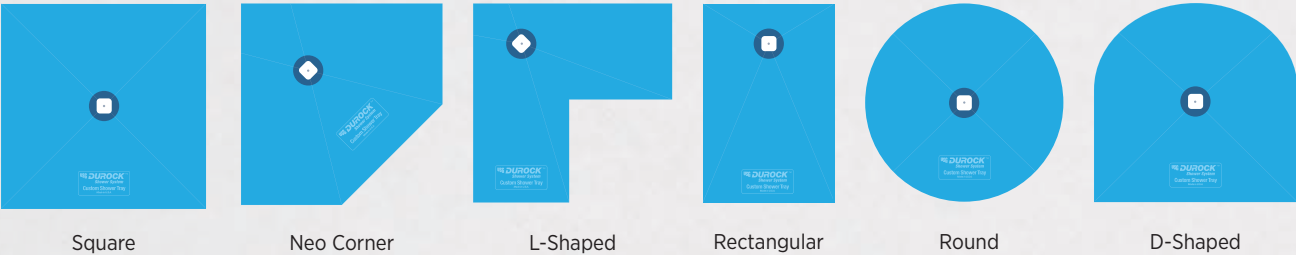

## USG DUROCK™ BRAND SHOWER SYSTEM – SHOWER KIT

| Product   | Item No.                           | Package Dimensions     | Weight lbs. | Pcs/Ctn | Ctn/Pallet |  |
|---|------------------------------------|------------------------|-------------|---------|------------|--|
| <b>48" x 48" Shower Kit</b>   |                                    |                        |             |         |            |  |
|  | 170132                             | L 51"<br>W 27"<br>H 9" | 25          | 1       | 12         |  |
|   | <b>32" x 60" Offset Shower Kit</b> |                        |             |         |            |  |
|   | 170133                             | L 51"<br>W 32"<br>H 9" | 28          | 1       | 12         |  |
| <b>32" x 60" Center Shower Kit</b>  |                                    |                        |             |         |            |  |
|   | 170134                             | L 51"<br>W 32"<br>H 9" | 28          | 1       | 12         |  |

Includes shower tray, shower curb(s), drain kit assembly, 36" x 50' membrane roll, 5" x 50' membrane band, 4 inside corners (2 packs) and 2 outside corners (1 pack), 1 pipe seal and 1 mixing valve seal. Grate kit assembly not included in shower kit (sold separately).



## USG DUROCK™ BRAND SHOWER SYSTEM – PRE-SLOPED SHOWER TRAY

| Product   | Item No. | Package Dimensions                 | Weight lbs. | Pcs/Ctn | Ctn/Pallet |
|---|----------|------------------------------------|-------------|---------|------------|
| <b>72" x 72" Shower Tray – Includes shower tray disk.</b>                           |          |                                    |             |         |            |
|   | 170105   | L 38-1/2"<br>W 37-1/4"<br>H 4-3/8" | 9           | 1       | 10         |
| <b>48" x 48" Shower Tray – Includes shower tray disk.</b>                           |          |                                    |             |         |            |
|  | 170141   | L 48-1/8"<br>W 25-3/4"<br>H 3"     | 6           | 1       | 15         |
| <b>32" x 60" Shower Tray (Offset Drain) – Includes shower tray disk.</b>            |          |                                    |             |         |            |
|  | 170142   | L 32-1/2"<br>W 31"<br>H 2-1/2"     | 5           | 1       | 15         |
| <b>32" x 60" Shower Tray (Center Drain) – Includes shower tray disk.</b>            |          |                                    |             |         |            |
|  | 170143   | L 32-1/2"<br>W 31"<br>H 2-3/4"     | 5           | 1       | 15         |

## USG DUROCK™ BRAND SHOWER SYSTEM – SHOWER TRAY DISK

| Product   | Item No. | Package Dimensions        | Weight lbs. | Pcs/Ctn | Ctn/Pallet |
|---|----------|---------------------------|-------------|---------|------------|
| <b>Shower Tray Disk</b>   |          |                           |             |         |            |
|  | 170152   | L 12"<br>W 12"<br>H 0.56" | < 1         | 54      | N/A        |





## USG DUROCK™ BRAND SHOWER SYSTEM – CURB AND RAMPS

| Product   | Item No. | Package Dimensions                 | Weight lbs. | Pcs/Ctn | Ctn/Pallet |
|---|----------|------------------------------------|-------------|---------|------------|
| <b>48" x 5" x 4" – 48" Curb</b>   |          |                                    |             |         |            |
|    | 170144   | L 49-3/4"<br>W 6-3/4"<br>H 5"      | 2           | 1       | 56         |
| <b>Ramp 60"</b>   |          |                                    |             |         |            |
|    | 170009   | L 60-1/2"<br>W 12-1/4"<br>D 1-1/4" | 2.4         | 6       | 18         |
| <b>Ramp 48"</b>   |          |                                    |             |         |            |
|  | 170131   | L 49-3/8"<br>W 12-1/4"<br>D 1-1/4" | 2           | 6       | 18         |

## USG DUROCK™ BRAND SHOWER SYSTEM – WATERPROOFING MEMBRANE

| Product   | Item No.              | Package Dimensions | Weight lbs. | Pcs/Ctn | Ctn/Pallet |  |
|---|-----------------------|--------------------|-------------|---------|------------|--|
| <b>36" x 100' Roll</b>  |                       |                    |             |         |            |  |
|  | 170146                | L 36"<br>D 6"      | 11          | 1       | 81         |  |
|   | <b>36" x 50' Roll</b> |                    |             |         |            |  |
|   | 170160                | L 36"<br>D 4"      | 7           | 1       | 120        |  |
| <b>36" x 25' Roll</b>   |                       |                    |             |         |            |  |
|   | 170097                | L 36"<br>D 3"      | 3           | 1       | 208        |  |
| <b>5" x 50' Band</b>  |                       |                    |             |         |            |  |
|  | 170148                | L 5"<br>D 4"       | 1           | 1       | 480        |  |

## USG DUROCK™ BRAND SHOWER SYSTEM – BENCH

| Product   | Item No. | Package Dimensions      | Weight lbs. | Pcs/Ctn | Ctn/Pallet |
|---|----------|-------------------------|-------------|---------|------------|
| <b>Shower Bench – Rectangle</b>   |          |                         |             |         |            |
|    | 170137   | L 34"<br>W 18"<br>H 22" | 21          | 1       | 9          |
| <b>Shower Bench – Square</b>  |          |                         |             |         |            |
|    | 170139   | L 18"<br>W 18"<br>H 22" | 12          | 1       | 16         |
| <b>Shower Bench – Triangle</b>  |          |                         |             |         |            |
|   | 170138   | L 18"<br>W 18"<br>H 22" | 6           | 1       | 24         |
| <b>Shower Bench – Quarter Round</b>   |          |                         |             |         |            |
|  | 170109   | L 18"<br>W 18"<br>H 22" | 11          | 1       | 16         |

## USG DUROCK™ BRAND SHOWER SYSTEM – NICHE

| Product   | Item No. | Package Dimensions   | Weight lbs. | Pcs/Ctn | Ctn/Pallet |
|---|----------|--|-------------|---------|------------|
| <b>Rectangular Niche</b>  |          |  |             |         |            |
|  | 170135   | L 17-1/2"<br>W 26"<br>H 4-3/4"<br><br>(Opening size is 13-3/4" x 22" x 3-5/8")         | 5           | 1       | 21         |
| <b>Square Niche</b>   |          |  |             |         |            |
|  | 170136   | L 17-1/2"<br>W 17-1/2"<br>H 4-3/4"<br><br>(Opening size is 13-3/4" x 13-3/4" x 3-5/8") | 4           | 1       | 28         |



### USG DUROCK™ BRAND SHOWER SYSTEM – PREFORMED INSIDE CORNER

| Product   | Item No. | Package Dimensions     | Weight lbs. | Pcs/Ctn | Ctn/Pallet                     |
|---|----------|------------------------|-------------|---------|--------------------------------|
| <b>Inside Corners – 2 per carton (36 cartons per master pack)</b>                 |          |                        |             |         |                                |
|  | 170120   | W 6"<br>H 7"<br>D 1/4" | < 1         | 2       | Cartons per master pack:<br>36 |

### USG DUROCK™ BRAND SHOWER SYSTEM – PREFORMED OUTSIDE CORNER

| Product   | Item No. | Package Dimensions     | Weight lbs. | Pcs/Ctn | Ctn/Pallet                     |
|---|----------|------------------------|-------------|---------|--------------------------------|
| <b>Outside Corners – 2 per carton (36 cartons per master pack)</b>                |          |                        |             |         |                                |
|  | 170125   | W 6"<br>H 7"<br>D 1/4" | < 1         | 2       | Cartons per master pack:<br>36 |

### USG DUROCK™ BRAND SHOWER SYSTEM – PIPE SEAL

| Product  | Item No. | Package Dimensions              | Weight lbs. | Pcs/Ctn | Ctn/Pallet                     |
|--|----------|---------------------------------|-------------|---------|--------------------------------|
| <b>Pipe Seal</b>   |          |                                 |             |         |                                |
|  | 170126   | W 7-1/2"<br>H 8-1/2"<br>D 1/16" | < 1         | 1       | Cartons per master pack:<br>24 |

### USG DUROCK™ BRAND SHOWER SYSTEM – MIXING VALVE SEAL

| Product   | Item No. | Package Dimensions            | Weight lbs. | Pcs/Ctn | Ctn/Pallet                     |
|---|----------|-------------------------------|-------------|---------|--------------------------------|
| <b>Mixing Valve Seal</b>  |          |                               |             |         |                                |
|  | 170128   | W 9-3/8"<br>H 10-5/8"<br>D 1" | < 1         | 1       | Cartons per master pack:<br>24 |

### USG DUROCK™ BRAND SHOWER SYSTEM – DRAIN KIT ASSEMBLY

| Product   | Item No. | Package Dimensions                 | Weight lbs. | Pcs/Ctn | Ctn/Pallet |
|---|----------|------------------------------------|-------------|---------|------------|
| <b>Drain Kit Assembly – Includes 1 PVC and 1 ABS bushing, rubber o-ring, bonding flange and construction cover.</b> |          |                                    |             |         |            |
|                                  | 170150   | L 11-1/4"<br>W 10-3/4"<br>H 3-1/2" | 2           | 1       | 120        |

### USG DUROCK™ BRAND SEALANT

| Product   | Item No. | Package Dimensions               | Weight lbs. | Pcs/Ctn | Ctn/Pallet |
|---|----------|----------------------------------|-------------|---------|------------|
|  | 170161   | W 7-7/8"<br>H 5-7/8"<br>D 9-5/8" | 15          | 12      | 108        |

## USG DUROCK™ BRAND SHOWER SYSTEM – PRO SERIES GRATE

**Grate Kit Assembly** – Includes grate, construction plug, grate tray, grate tray riser, horizontal adjustment ring and grate puller.

| Product   | Item No./Finish              | Package Dimensions            | Weight lbs. | Pcs/Ctn | Ctn/Pallet |
|---|------------------------------|-------------------------------|-------------|---------|------------|
| <b>Antique Copper</b>   | <b>4" Professional Grate</b> |                               |             |         |            |
|    | 170164<br>Antique Copper     | L: 7-1/4" W: 8-1/2" H: 1-7/8" | 1           | 1       | N/A        |
|   | <b>5" Professional Grate</b> |                               |             |         |            |
|   | 170179<br>Antique Copper     | L: 8-1/4" W: 9-1/2" H: 1-7/8" | 1           | 1       | N/A        |
| <b>Black Chrome</b>   | <b>4" Professional Grate</b> |                               |             |         |            |
|    | 170157<br>Black Chrome       | L: 7-1/4" W: 8-1/2" H: 1-7/8" | 1           | 1       | N/A        |
|   | <b>5" Professional Grate</b> |                               |             |         |            |
|   | 170170<br>Black Chrome       | L: 8-1/4" W: 9-1/2" H: 1-7/8" | 1           | 1       | N/A        |
| <b>Brushed Nickel</b>   | <b>4" Professional Grate</b> |                               |             |         |            |
|    | 170154<br>Brushed Nickel     | L: 7-1/4" W: 8-1/2" H: 1-7/8" | 1           | 1       | N/A        |
|   | <b>5" Professional Grate</b> |                               |             |         |            |
|   | 170166<br>Brushed Nickel     | L: 8-1/4" W: 9-1/2" H: 1-7/8" | 1           | 1       | N/A        |
| <b>Chrome</b>   | <b>4" Professional Grate</b> |                               |             |         |            |
|   | 170153<br>Chrome             | L: 7-1/4" W: 8-1/2" H: 1-7/8" | 1           | 1       | N/A        |
|   | <b>5" Professional Grate</b> |                               |             |         |            |
|   | 170165<br>Chrome             | L: 8-1/4" W: 9-1/2" H: 1-7/8" | 1           | 1       | N/A        |
| <b>Oil Rubbed Bronze</b>  | <b>4" Professional Grate</b> |                               |             |         |            |
|  | 170156<br>Oil Rubbed Bronze  | L: 7-1/4" W: 8-1/2" H: 1-7/8" | 1           | 1       | N/A        |
|   | <b>5" Professional Grate</b> |                               |             |         |            |
|   | 170168<br>Oil Rubbed Bronze  | L: 8-1/4" W: 9-1/2" H: 1-7/8" | 1           | 1       | N/A        |
| <b>Pewter</b>   | <b>4" Professional Grate</b> |                               |             |         |            |
|  | 170162<br>Pewter             | L: 7-1/4" W: 8-1/2" H: 1-7/8" | 1           | 1       | N/A        |
|   | <b>5" Professional Grate</b> |                               |             |         |            |
|   | 170178<br>Pewter             | L: 8-1/4" W: 9-1/2" H: 1-7/8" | 1           | 1       | N/A        |
| <b>Polished Gold</b>  | <b>4" Professional Grate</b> |                               |             |         |            |
|  | 170158<br>Polished Gold      | L: 7-1/4" W: 8-1/2" H: 1-7/8" | 1           | 1       | N/A        |
|   | <b>5" Professional Grate</b> |                               |             |         |            |
|   | 170177<br>Polished Gold      | L: 8-1/4" W: 9-1/2" H: 1-7/8" | 1           | 1       | N/A        |
| <b>Polished Nickel</b>  | <b>4" Professional Grate</b> |                               |             |         |            |
|  | 170155<br>Polished Nickel    | L: 7-1/4" W: 8-1/2" H: 1-7/8" | 1           | 1       | N/A        |
|   | <b>5" Professional Grate</b> |                               |             |         |            |
|   | 170167<br>Polished Nickel    | L: 8-1/4" W: 9-1/2" H: 1-7/8" | 1           | 1       | N/A        |

## USG DUROCK™ BRAND SHOWER SYSTEM – DESIGNER SERIES GRATE

**Grate Kit Assembly** – Includes grate, construction plug, grate tray, grate tray riser, horizontal adjustment ring and grate puller.

| Product   | Item No.                          | Package Dimensions        | Weight lbs. | Pcs/Ctn | Ctn/Pallet |
|---|-----------------------------------|---------------------------|-------------|---------|------------|
| <b>LATTICE</b>  |                                   |                           |             |         |            |
| Brushed Stainless<br>    | <b>4" Designer Lattice Grate</b>  |                           |             |         |            |
|   | 170825                            | L: 8" W: 7-3/4" H: 2-3/8" | 1           | 1       | N/A        |
|   | <b>5" Designer Lattice Grate</b>  |                           |             |         |            |
|   | 170828                            | L: 8" W: 7-3/4" H: 2-3/8" | 2           | 1       | N/A        |
| Oil Rubbed Bronze<br>    | <b>4" Designer Lattice Grate</b>  |                           |             |         |            |
|   | 170827                            | L: 8" W: 7-3/4" H: 2-3/8" | 1           | 1       | N/A        |
|   | <b>5" Designer Lattice Grate</b>  |                           |             |         |            |
|   | 170830                            | L: 8" W: 7-3/4" H: 2-3/8" | 2           | 1       | N/A        |
| Polished Stainless<br>   | <b>4" Designer Lattice Grate</b>  |                           |             |         |            |
|   | 170826                            | L: 8" W: 7-3/4" H: 2-3/8" | 1           | 1       | N/A        |
|   | <b>5" Designer Lattice Grate</b>  |                           |             |         |            |
|   | 170829                            | L: 8" W: 7-3/4" H: 2-3/8" | 2           | 1       | N/A        |
| <b>PARALLEL</b>   |                                   |                           |             |         |            |
| Brushed Stainless<br>  | <b>4" Designer Parallel Grate</b> |                           |             |         |            |
|   | 170849                            | L: 8" W: 7-3/4" H: 2-3/8" | 1           | 1       | N/A        |
|   | <b>5" Designer Parallel Grate</b> |                           |             |         |            |
|   | 170852                            | L: 8" W: 7-3/4" H: 2-3/8" | 2           | 1       | N/A        |
| Oil Rubbed Bronze<br>  | <b>4" Designer Parallel Grate</b> |                           |             |         |            |
|   | 170851                            | L: 8" W: 7-3/4" H: 2-3/8" | 1           | 1       | N/A        |
|   | <b>5" Designer Parallel Grate</b> |                           |             |         |            |
|   | 170854                            | L: 8" W: 7-3/4" H: 2-3/8" | 2           | 1       | N/A        |
| Polished Stainless<br> | <b>4" Designer Parallel Grate</b> |                           |             |         |            |
|   | 170850                            | L: 8" W: 7-3/4" H: 2-3/8" | 1           | 1       | N/A        |
|   | <b>5" Designer Parallel Grate</b> |                           |             |         |            |
|   | 170853                            | L: 8" W: 7-3/4" H: 2-3/8" | 2           | 1       | N/A        |





## USG DUROCK™ BRAND SHOWER SYSTEM – DESIGNER SERIES GRATE

**Grate Kit Assembly** – Includes grate, construction plug, grate tray, grate tray riser, horizontal adjustment ring and grate puller.

| Product   | Item No.                          | Package Dimensions        | Weight lbs. | Pcs/Ctn | Ctn/Pallet |
|---|-----------------------------------|---------------------------|-------------|---------|------------|
| <b>SANTA FE</b>   |                                   |                           |             |         |            |
| Brushed Stainless<br>    | <b>4" Designer Santa Fe Grate</b> |                           |             |         |            |
|   | 170831                            | L: 8" W: 7-3/4" H: 2-3/8" | 1           | 1       | N/A        |
|   | <b>5" Designer Santa Fe Grate</b> |                           |             |         |            |
|   | 170834                            | L: 8" W: 7-3/4" H: 2-3/8" | 2           | 1       | N/A        |
| Oil Rubbed Bronze<br>    | <b>4" Designer Santa Fe Grate</b> |                           |             |         |            |
|   | 170833                            | L: 8" W: 7-3/4" H: 2-3/8" | 1           | 1       | N/A        |
|   | <b>5" Designer Santa Fe Grate</b> |                           |             |         |            |
|   | 170836                            | L: 8" W: 7-3/4" H: 2-3/8" | 2           | 1       | N/A        |
| Polished Stainless<br>   | <b>4" Designer Santa Fe Grate</b> |                           |             |         |            |
|   | 170832                            | L: 8" W: 7-3/4" H: 2-3/8" | 1           | 1       | N/A        |
|   | <b>5" Designer Santa Fe Grate</b> |                           |             |         |            |
|   | 170835                            | L: 8" W: 7-3/4" H: 2-3/8" | 2           | 1       | N/A        |
| <b>SPLASH</b>   |                                   |                           |             |         |            |
| Brushed Stainless<br>  | <b>4" Designer Splash Grate</b>   |                           |             |         |            |
|   | 170843                            | L: 8" W: 7-3/4" H: 2-3/8" | 1           | 1       | N/A        |
|   | <b>5" Designer Splash Grate</b>   |                           |             |         |            |
|   | 170846                            | L: 8" W: 7-3/4" H: 2-3/8" | 2           | 1       | N/A        |
| Oil Rubbed Bronze<br>  | <b>4" Designer Splash Grate</b>   |                           |             |         |            |
|   | 170845                            | L: 8" W: 7-3/4" H: 2-3/8" | 1           | 1       | N/A        |
|   | <b>5" Designer Splash Grate</b>   |                           |             |         |            |
|   | 170848                            | L: 8" W: 7-3/4" H: 2-3/8" | 2           | 1       | N/A        |
| Polished Stainless<br> | <b>4" Designer Splash Grate</b>   |                           |             |         |            |
|   | 170844                            | L: 8" W: 7-3/4" H: 2-3/8" | 1           | 1       | N/A        |
|   | <b>5" Designer Splash Grate</b>   |                           |             |         |            |
|   | 170847                            | L: 8" W: 7-3/4" H: 2-3/8" | 2           | 1       | N/A        |

## USG DUROCK™ BRAND SHOWER SYSTEM – DESIGNER SERIES GRATE

**Grate Kit Assembly** – Includes grate, construction plug, grate tray, grate tray riser, horizontal adjustment ring and grate puller.

| Product   | Item No.                       | Package Dimensions        | Weight lbs. | Pcs/Ctn | Ctn/Pallet |
|---|--------------------------------|---------------------------|-------------|---------|------------|
| <b>SURF</b>   |                                |                           |             |         |            |
| Brushed Stainless<br>    | <b>4" Designer Surf Grate</b>  |                           |             |         |            |
|   | 170855                         | L: 8" W: 7-3/4" H: 2-3/8" | 1           | 1       | N/A        |
|   | <b>5" Designer Surf Grate</b>  |                           |             |         |            |
|   | 170858                         | L: 8" W: 7-3/4" H: 2-3/8" | 2           | 1       | N/A        |
| Oil Rubbed Bronze<br>    | <b>4" Designer Surf Grate</b>  |                           |             |         |            |
|   | 170857                         | L: 8" W: 7-3/4" H: 2-3/8" | 1           | 1       | N/A        |
|   | <b>5" Designer Surf Grate</b>  |                           |             |         |            |
|   | 170861                         | L: 8" W: 7-3/4" H: 2-3/8" | 2           | 1       | N/A        |
| Polished Stainless<br>   | <b>4" Designer Surf Grate</b>  |                           |             |         |            |
|   | 170856                         | L: 8" W: 7-3/4" H: 2-3/8" | 1           | 1       | N/A        |
|   | <b>5" Designer Surf Grate</b>  |                           |             |         |            |
|   | 170859                         | L: 8" W: 7-3/4" H: 2-3/8" | 2           | 1       | N/A        |
| <b>WHIRL</b>  |                                |                           |             |         |            |
| Brushed Stainless<br>  | <b>4" Designer Whirl Grate</b> |                           |             |         |            |
|   | 170837                         | L: 8" W: 7-3/4" H: 2-3/8" | 1           | 1       | N/A        |
|   | <b>5" Designer Whirl Grate</b> |                           |             |         |            |
|   | 170840                         | L: 8" W: 7-3/4" H: 2-3/8" | 2           | 1       | N/A        |
| Oil Rubbed Bronze<br>  | <b>4" Designer Whirl Grate</b> |                           |             |         |            |
|   | 170839                         | L: 8" W: 7-3/4" H: 2-3/8" | 1           | 1       | N/A        |
|   | <b>5" Designer Whirl Grate</b> |                           |             |         |            |
|   | 170842                         | L: 8" W: 7-3/4" H: 2-3/8" | 2           | 1       | N/A        |
| Polished Stainless<br> | <b>4" Designer Whirl Grate</b> |                           |             |         |            |
|   | 170838                         | L: 8" W: 7-3/4" H: 2-3/8" | 1           | 1       | N/A        |
|   | <b>5" Designer Whirl Grate</b> |                           |             |         |            |
|   | 170841                         | L: 8" W: 7-3/4" H: 2-3/8" | 2           | 1       | N/A        |

## GRATE KIT ASSEMBLY

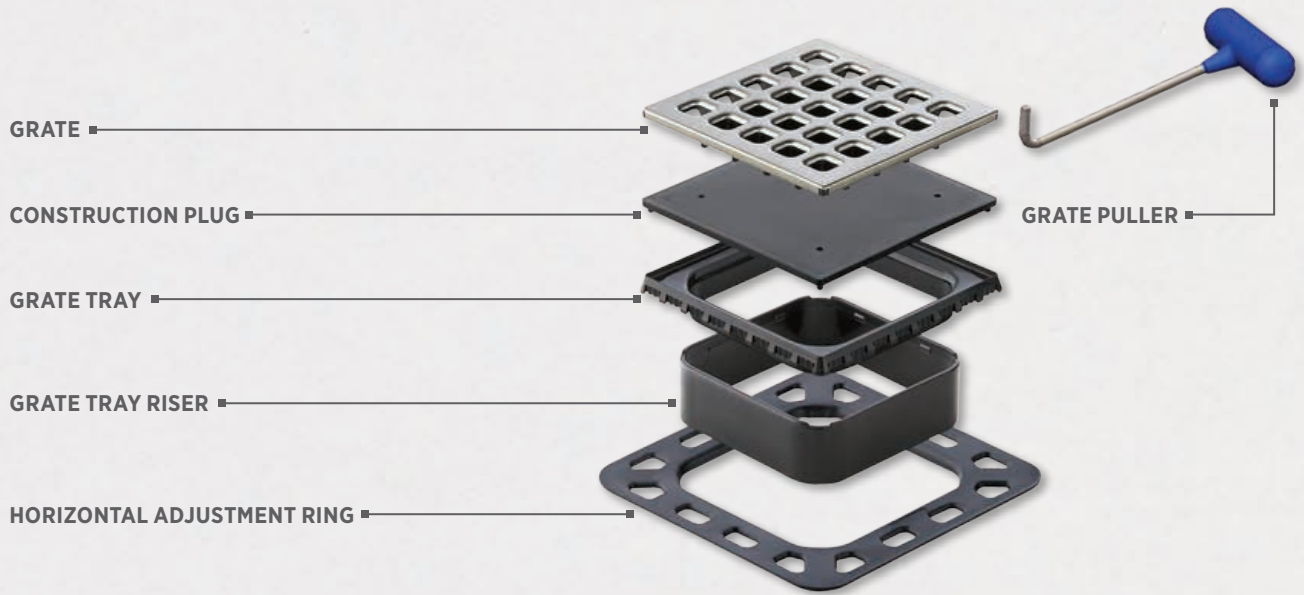

## NOTES



