

Item # 1003 371 890  
Item # 1003 371 891  
Item # 1003 371 874



Model #191-A19-26H-CHS-4WH  
Model #191-A19-26H-CHS-4BR  
Model #191-A19-26H-CHS-4BL

## USE AND CARE GUIDE

---

### STERLING 4-PACK ALUMINUM PVC STRAP CHAISE LOUNGE

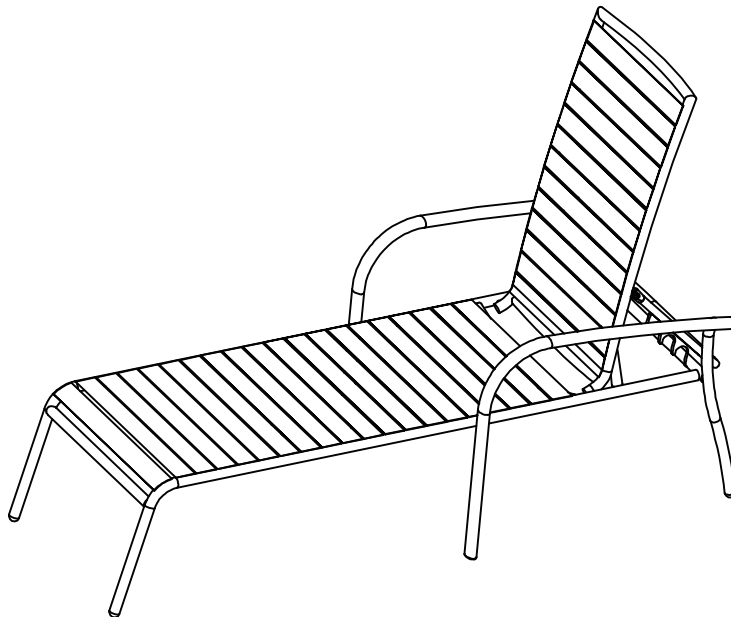

Questions, problems, missing parts? Before returning to the store,  
call Hampton Bay Customer Service  
8.00 a.m. - 7.00 p.m. EST, Monday - Friday,  
9.00 a.m. - 6.00 p.m. EST, Saturday

**1-855-HD-HAMPTON**

**HAMPTONBAY.COM**

---

#### **THANK YOU**

*We appreciate the trust and confidence you have placed in Hampton Bay through the purchase of this chaise lounge. We strive to continually create quality products designed to enhance your home. Visit us online to see our full line of products available for your home improvement needs. Thank you for choosing Hampton Bay!*

# Table of Contents

Table of Contents .....	2	Pre-Assembly.....	3
Important Safety Instructions .....	2	Planning Assembly .....	3
Warranty .....	2	Hardware Included.....	3
2 Year Frame Limited Warranty.....	2	Package Contents .....	4
What Is Covered .....	2	Assembly.....	5
What Is Not Covered .....	2		
Care & Cleaning .....	2		

# Important Safety Instructions

## SAVE THESE INSTRUCTIONS



**WARNING:** Keep your fingers clear while switching the positions of the chaise lounge back.



**CAUTION:** Use the chaise lounge on flat ground only.

## READ ALL INSTRUCTIONS BEFORE USE

When using a furnishing, basic precautions should always be followed, including the following:

Read all instructions before using this furnishing.

To reduce the risk of injury to persons:

- a) Close supervision is necessary when this furnishing is used by or near children, or disabled persons, if applicable.
- b) Use this furnishing only for its intended use as described in these instructions. Do not use attachments not recommended by the manufacturer.
- c) Do not move the chaise lounge chair when it is occupied. Failure to obey this caution could result in injury.

# Warranty

## 2 YEAR FRAME LIMITED WARRANTY

### WHAT IS COVERED

We warrant the frame to be free of manufacturing defects to the original purchaser for two years.

### WHAT IS NOT COVERED

It remains the customer's responsibility for freight and packaging charges to and from our service center. This warranty does not cover commercial use, hardware, acts of nature, fire, freezing and abusive use. In addition, purchased parts are not covered under this warranty. We reserve the right to make substitutions with similar merchandise, if the model in question is no longer in production.

# Care & Cleaning

Before using, wipe with a clean, dry cloth. Do not use bleach or solvents. Treat the frame with liquid wax for maximum protection against UV light and salty, damp air. When not in use, store the furniture in a cool, dry place.

You may contact our customer service department with any questions by phone at 1-855-HD-HAMPTON or visit [www.hamptonbay.com](http://www.hamptonbay.com).

# Pre-Assembly

## PLANNING ASSEMBLY

It will take two people about 10 minutes to complete the assembly process.

## HARDWARE INCLUDED



**NOTE:** Hardware not shown to actual size.



AA



BB



CC

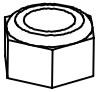

DD

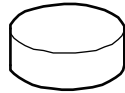

EE

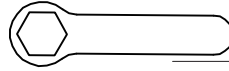

FF



GG

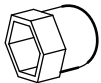

HH

Part	Description	Quantity
AA	Bolt (M6x70)	8
BB	Washer (M6)	8
CC	Plastic washer (M6)	8
DD	Nut (M6)	8
EE	Bolt cap	8
FF	Wrench	1
GG	Hex wrench	1
HH	Nut cap	8

# Pre-Assembly (continued)

## PACKAGE CONTENTS

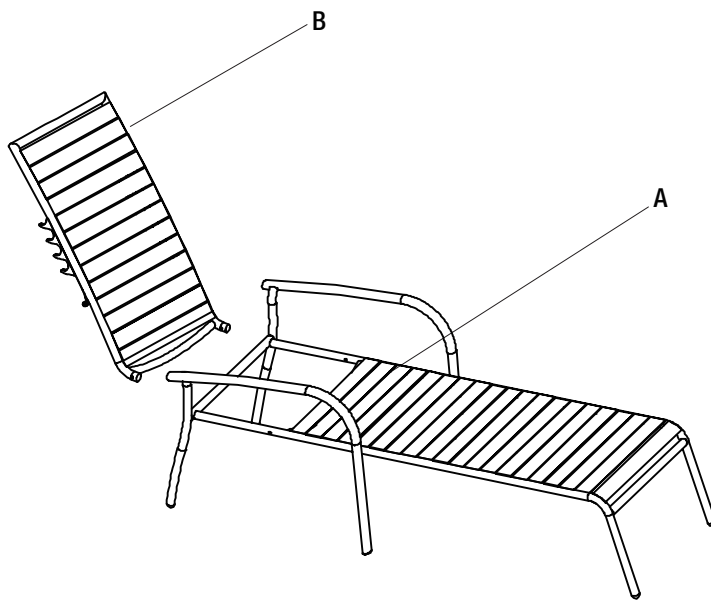

Part	Description	Quantity
A	Seat	4
B	Back panel	4

# Assembly

## 1 Attaching the back panel

- Place the seat (A) of the chaise lounge on a flat, smooth surface. Align the back panel (B) to the seat.
- Attach the back panel (B) to the seat (A) with bolts (AA), plastic washers (CC), washers (BB), nuts (DD) and nut caps (HH) using wrenches (FF) and (GG).
- Repeat the above procedure for the other chaise lounges.

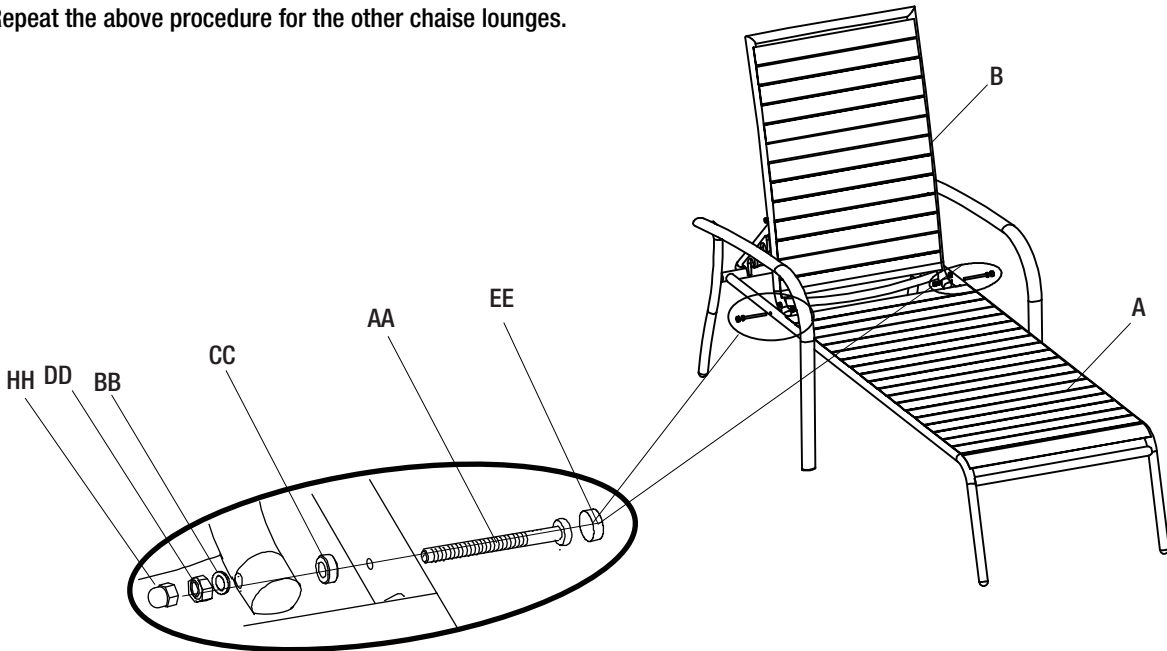

## 2 Fixing the back panel before use



**IMPORTANT:**  
Before using the chaise lounge the back panel must be firmly locked in place .



**NOTE:** You can lock the chaise back in four different positions.



**WARNING:** Never try to adjust the chaise back while sitting in the chaise.

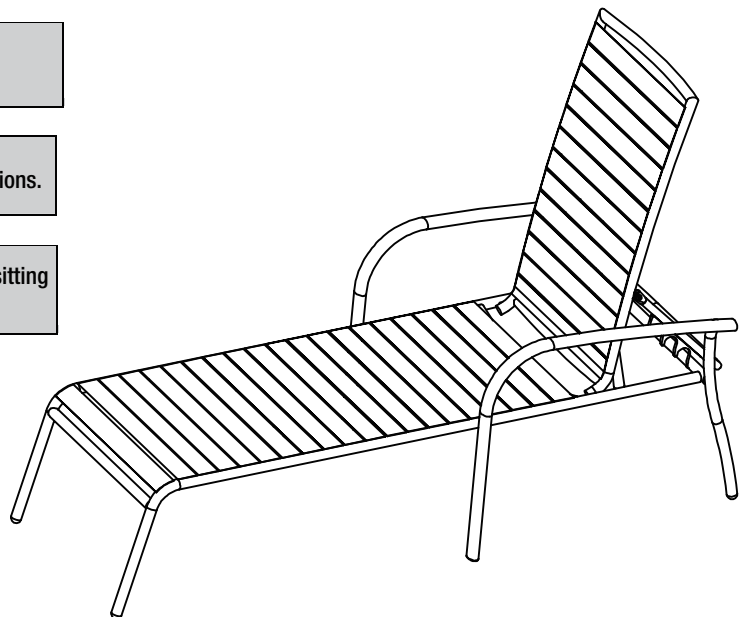



Questions, problems, missing parts? Before returning to the store,  
call Hampton Bay Customer Service  
8.00 a.m. - 7.00 p.m. EST, Monday - Friday,  
9.00 a.m. - 6.00 p.m. EST, Saturday

**1-855-HD-HAMPTON**

**HAMPTONBAY.COM**

Retain this manual for future use.