

NOTICE: This .pdf file should not be used as the source to create final, printed pieces of the file it represents. Rather, it is a low resolution visual reference only containing relevant information regarding the file (e.g., color, text and image placement, etc.)



FLUID



ASSEMBLY AND OPERATING INSTRUCTIONS FOR YOUR ORBIT® HEAVY-DUTY TRAVELING SPRINKLER

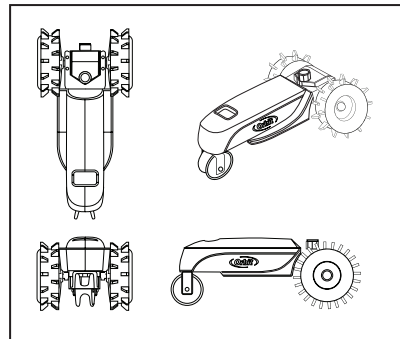
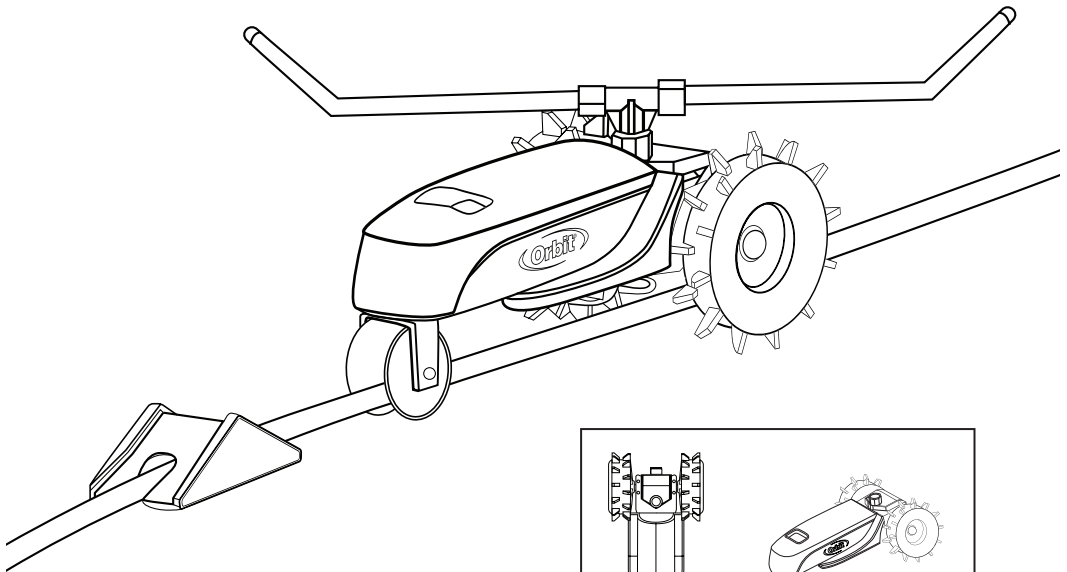

Model 58322

1. Sprinkler assembly

Begin by inserting the black plastic T into the top of the sprinkler. Twist the long silver spray arms into the T, tightening the black rings until the spray arms are held securely in place.

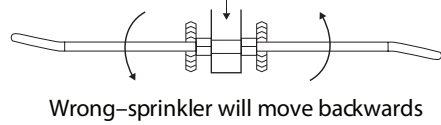
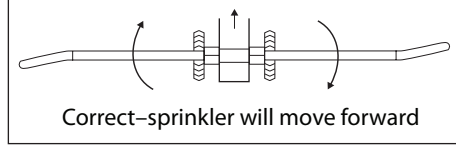
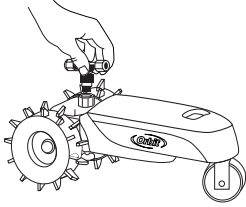

2. Positioning the arms

Positioning the spray arms correctly will ensure proper operation of your sprinkler. Move each spray arm individually to adjust watering diameter from a minimum of 15 feet to 55 feet.

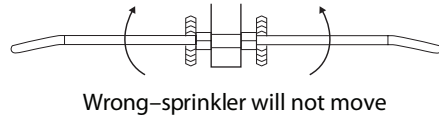
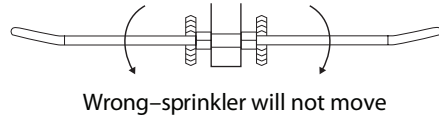
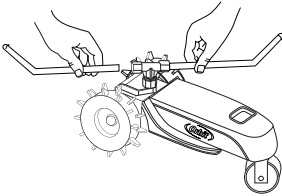

Arm Position	Path	Inches of Water	Speed
	15' Wide	2/3"	High
		1"	Low
	30' Wide	1/3"	High
		3/4"	Low
	45' Wide	1/4"	High
		1/2"	Low
	55' Wide	3/16"	High
		1/4"	Low

Chart calculated using 5/8" hose up to 200' long with average water pressure of 40 psi.

5/8" Hose Diameter	Max. Travel Length	Average Travel Speed (feet per hour)		Approximate Water Application		Area Coverage			
		High Gear Max.	Low Gear Min.	High Gear	Low Gear	Max. Width	Max. sq.ft.	Effective Width	Effective sq.ft.
Standard Traveler	200'	37'	21'	1/4"	1/2"	55'	13,500	54'	11,900

Distance may vary depending on hose weight.

For narrow spray coverage, move the arms so they are pointing slightly downward.

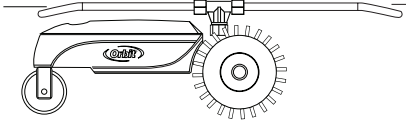

For wide spray coverage, move the arms so they are pointing upward approximately 30 degrees.

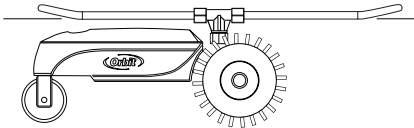

For windy conditions, move the arms to a horizontal position.

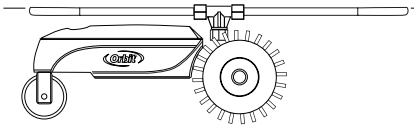

Pointing the arms too far downward will cause the arms to become stuck and immobilize the sprinkler.

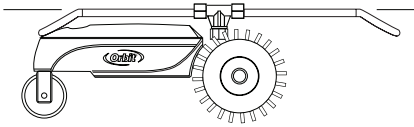

3. Setting up the hose

Lay up to 200 feet of 5/8" hose in any pattern you select on lawn that is fully grown—the sprinkler may not work on new or recently seeded lawns. Begin by creating at least a three-foot loop with the end of the hose to prevent pinching when connecting to the sprinkler. Do not create sharp turns in the hose pattern.

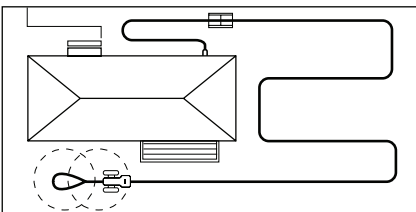

4. Positioning the shut-off ramp

The shut-off ramp may be used at any point along the hose pattern to stop the sprinkler. Place the automatic shut-off ramp over the hose where you want the sprinkler to stop, ensuring a minimum of 5 feet of straight hose on either end of the ramp.

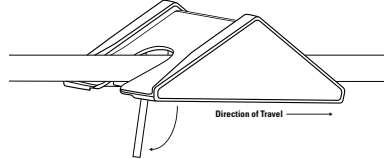

5. Hooking up the sprinkler

Set the sprinkler on the hose so that the front tire is on the hose and the back wheels are on either side. Make sure the sprinkler is facing the direction you would like it to go. Hook up the hose to the rear of the sprinkler.

6. Setting the sprinkler's speed

Select a traveling speed by pulling up on and rotating the dial on the top of the sprinkler. The sprinkler will travel from 0 to 37 feet per hour based on setting.

- High:** Select this speed for faster movement and light watering
- Low:** Select this speed for slower movement and heavier watering
- Neutral:** Select this speed for no movement; the sprinkler will remain stationary and water a designated area.

7. Running the sprinkler

Pull out the stopper underneath the sprinkler between the back wheels and turn on the water supply. The sprinkler will move at the speed indicated along the hose track, stopping when its shut-off plunger contacts the ramp stop.

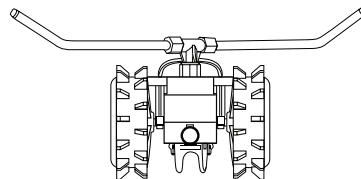

8. Stopping the sprinkler

When the sprinkler comes in contact with the shut-off ramp, the incline causes the stopper to be pushed up, stopping the sprinkler.

9. Moving the sprinkler

Before repositioning the hose and moving the sprinkler to another part of the lawn, be sure to turn off the water first. Eliminate excess pressure from the hose and pull the sprinkler's stopper back out before beginning again in a new area. It will be very difficult to move the stopper back down if water pressure remains in the hose.

10. Cleaning up

To keep the Orbit® Heavy-Duty Traveling Sprinkler operating within peak parameters, be sure that the filter washer at the hose coupling and the spray arms remain clean and unblocked. Consistently drain the sprinkler after each use by standing it on end for at least five minutes to ensure all water is eliminated from the sprinkler's interior.

11. Preventing sprinkler damage

Use caution when picking up and moving the sprinkler—dropping it could potentially result in damage to the sprinkler or its parts. Do not force the sprinkler to move faster or slower along the track while it is in operation. Do not let the sprinkler become mired in thick grass or mud. Be sure there are no objects blocking the path of the sprinkler. The sprinkler is designed to move across grass only—never attempt to use the sprinkler on concrete driveways, sidewalks, or other hard surfaces. Doing so may result in severe damage to the motor assembly.

Customer Service Contact Information

Technical Help at:
1-800-488-6156 or (801) 299-5555.

Orbit® Warranty

Orbit® Irrigation Products, Inc. warrants to its customers that its products will be free from defects in materials and workmanship for a period of six years from the date of purchase.

We will replace, free of charge, the defective part or parts found to be defective under normal use and service for a period of up to six years after purchase (proof of purchase required).

We reserve the right to inspect the defective part prior to replacement. Orbit® Irrigation Products, Inc. will not be responsible for consequential or incidental cost or damage caused by the product failure. Orbit® liability under this warranty is limited solely to the replacement or repair of defective parts.

If you need help with product operation or replacement parts, please do not return this sprinkler to the retailer where it was purchased. If you contact Orbit at the Web site or toll-free number below, we would be pleased to assist you.

SAFETY OF CHILDREN: This sprinkler is not intended for use by young children.

For outdoor use with cold water only.
Do not spray near electrical connections.

Orbit® Irrigation Products, Inc.
North Salt Lake, UT 84054 USA
www.orbitonline.com | 1-800-488-6156