



A HISTORY OF EXCELLENCE.

IMPROVING THE ART OF FLUID MOTION™ FOR OVER 80 YEARS.

Ever since our modest beginnings, Danner Manufacturing, a family owned and operated business, has developed and produced innovative products for hobbyists and professionals alike.

Eugene Danner Sr. started planting the seeds for Danner Manufacturing in 1934 while working in the cellar of his home on Seneca Avenue in the Ridgewood district of Brooklyn, New York. While holding a full-time job as a factory manager, Eugene found great pride creating the Danner business on his time off from his regular full-time job duties. Eugene's first product was a small waterfall toy, which was used as a component in a toy sold by the world famous F•A•O Schwarz® toy store in New York City. Eugene Danner Sr. along with his children Eugene and Renate would travel from Brooklyn to Canal Street in Manhattan where they would purchase scrap metal for these waterfall toys.



Eugene Danner Sr. with his son, Eugene Danner and company Employee. Circa 1958



Eugene Danner Sr. Summerfield St. Brooklyn, NY Factory. Circa 1968

Around that time, the aquatics hobby began to grow and people who kept fish as pets were known as "Fish Fanciers." Eugene was often asked if he could make water and air pumps for this new-found hobby. From there, the "Supreme Aquarium" brand was born and the original Supreme Dynamaster® Air Pumps were introduced, which quickly became the standard to which others aspired.

At the end of World War II, Eugene's son came home from active duty and opened the first official Danner Manufacturing factory on Woodbine Street in Brooklyn. He took on his father's growing hobby as a full time business. At this time, Eugene Danner Sr. quit his job as a factory manager and started working full-time with his son to formulate what is now known as Danner Manufacturing. As the years progressed, Eugene and his son upgraded and opened up a new state-of-the-art factory in 1960 on Summerfield Street in Brooklyn.

In the 1960's, all three of Eugene Danner Sr's grandchildren started helping in the factory and in 1974 the Danner family moved its operations to a new facility in Islandia, NY. In 1987, Eugene passed the torch onto his son, Michael who ran the business until 2005. During this time, Michael's sister, Catherine Danner designed and developed many award-winning package designs throughout the 1980's. Their sister, Rosemarie is the current CEO of Danner Manufacturing and continues to carry on the great Danner legacy and tradition.

Over 80 years later, continuing with Eugene Danner Sr's vision, Danner Manufacturing still employs and manufactures within the United States. Our sophisticated and energy-efficient magnetically driven and hybrid pumps continue to be popular products with thousands of satisfied and loyal customers all over North America.

The brands which we manufacture and market are: Supreme Aquarium, Pondmaster, ProLine, Supreme Hydro, Pool-Care and Pondmaster ECO. These brands can be found in the Aquarium, Water Gardening, Pond, Pool & Spa, Hydroponic and OEM industries throughout North America and the offshore markets. We are committed to providing our customers with high quality and reasonably priced products, creating the best value.

AND INTRODUCING...



Introducing the Home Collection line of Meditation Fountains by Danner Manufacturing. The Halo, Aura and Pearl Meditation Fountains are our foray into the tabletop fountain market. They are stylish pieces of decor that fit on any tabletop, kitchen counter, living room table, bathroom sink, shelf, vanity or office desk while bringing a calm, Zen-like feel to any room in the house or work space. The Danner Home Collection line of Meditation Fountains are available now and ready to ship for the upcoming Holiday season. For more information, please visit page 97 and 98.

#SOCIALMEDIACRAZE



SCAN WITH YOUR PHONE USING INSTAGRAM AND TWITTER

Some of our customers might have noticed that our website got a face-lift last year. We're continually upgrading the site and adapting with current trends and the ever-growing online community. It's fully responsive with new and improved features and can be viewed from any of your devices — iPhone, Android, iPad, Laptop, you name it!

Speaking of mobile devices and upgrading... we've also dove head-deep into the craziness of social media. We now live in a world of #hashtags and @signs, so please come see what we're up to and like, follow, hashtag, comment and interact with us on Instagram, Twitter, FaceBook and YouTube — we can easily be found on all four platforms @dannermfg

VISIT US AT WWW.DANNERMFG.COM OR CALL 1-800-458-5876

VISIT US AT WWW.DANNERMFG.COM OR CALL 1-800-458-5876

PONDMASTER
PUMPS

- Pondmaster Pond-Mag® Magnetic Drive Water Pumps..... 5-7
- Pondmaster Hydro-Air® Submersible Water & Air Pump..... 8
- Pondmaster Waterfall/Skimmer Pumps 9
- Pondmaster Fountain-Mag® Magnetic Drive Water Pumps..... 10
- The Fountain Pump Fountain & Statuary Water Pumps..... 11
- Pondmaster Hy-Drive Water Pumps 12

PRESSURIZED FILTERS, UV CLARIFIERS, FILTRATION SYSTEMS AND POND KITS

- Pondmaster CPF Series Pressurized Filters 13
- Pondmaster Clearguard Pressurized Filter 14-16
- Pondmaster Clearguard UV Clarifier Kit, Backwash Air Kit and Accessories 17-18
- Pondmaster Ultraviolet Clarifiers 19
- Pondmaster Filtration Systems 20
- Pondmaster Pond Kits 21

AIR PUMPS

- Pondmaster Air Pumps and Pond Aeration Kit 22

PUMP TREATMENTS, CLEANERS AND FOOD

- Pondmaster PumpGuard 23
- Pondmaster Pond-Clean and Pondmaster Koi Food 24
- Pondmaster Water Treatments 25-26

ACCESSORIES AND REPLACEMENT PARTS

- Pondmaster Fountain Head Kits and Disappearing Fountain Basin 27
- Pondmaster LED Lighted Spillway..... 28
- Pondmaster LED Light Ring Kits and Pondmaster Photosensor LED Lights 29
- Pondmaster Spouting Pond Statues..... 30
- Pondmaster De-Icer, Floating Pond Thermometer, Air Diffusers and Aquatic Plant Basket 31
- Pondmaster Super-Flex Pond Liners..... 32
- Pondmaster Pond Netting and Pond Nets 33
- Pondmaster Tubing, Pump Bags and Barb Fittings..... 34
- Pondmaster Replacement Filter Media and Impellers 35-36
- Pondmaster D-I-Y Pond Menu Header and "Let's Get Started" Plan-o-grams 37-38

PONDMASTER ECO

PUMPS

- Pondmaster Eco Submersible Water Pumps..... 41-42
- Pondmaster Eco Fountainhead & Pump Kits..... 44

ProLine

PRESSURIZED FILTERS

- ProLine Pressurized Filters 47-48

PUMPS

- ProLine HFS Submersible Water Pumps 49
- ProLine Hy-Drive Water Pumps 50
- ProLine Skimmer Pumps with Hy-Drive Technology 51

SKIMMERS, FILTER AND FALLS, PUMP VAULTS AND WATER FEATURES

- ProLine Pro1000, Pro2000, Pro3000 Filter and Falls..... 52
- ProLine Pro5000 Filter and Falls and Pro5000 Skimmer..... 53
- ProLine Pump Vaults 54
- ProLine App-Controlled Multi-Color LED Spillways 55-56

TABLE OF CONTENTS

Supreme AQUARIUM

PUMPS

- Supreme Aqua-Mag® Magnetic Drive Water Pumps 59
- Supreme Aqua-Mag® Air Fractionating Water Pumps 60
- The Aquarium Pump 61
- Supreme Hy-Drive Water Pumps 62

FILTERS

- Supreme EZ Clean External Aquarium Filter 63
- Supreme EZ Clean Internal Aquarium Filter 64
- Supreme Skilter Protein Skimmer and Aerating Power Filter..... 65
- Supreme Ovation Submersible Power Jet Filters 66

AIR PUMPS

- Supreme Oxy-Flo Aquarium Air Pumps 67-68

PUMP TREATMENTS

- Supreme Pumpguard and Aqua-Clean..... 69

REPLACEMENT PARTS

- Supreme Replacement Filter Media and Impellers 70
- "Let's Get Started" Plan-o-grams..... 71-72

Supreme HYDRO

PUMPS

- Supreme Hydro-Mag® Recirculating Water & Air Pumps 75
- Supreme Hy-Drive Recirculating Water Pumps 76
- Hydro-Air® Submersible Water & Air Pump 77
- The Growers Pump..... 78
- Supreme Cloning Pump with Spray Head 79

DE-WATERING PUMPS

- Supreme De-Watering Pumps 80

AIR PUMPS

- Supreme Oxy-Flo Air Pumps 81-82

PUMP TREATMENTS

- Supreme Hydro-Clean 83

ACCESSORIES AND REPLACEMENT PARTS

- Air Diffusers and Supreme Ebb & Flow Kit..... 84
- Air Stones, Tubing and Check Valves..... 85
- Supreme Replacement Parts..... 86

POOL-CARE
BY DANNER MANUFACTURING

PUMPS

- Cover-Care Magnetic Drive Pool Cover Pumps & Automatic Pool Cover Pump..... 89-90

DE-WATERING PUMPS

- Pool-Care Main Drain Utility/Pool Pump 91
- Pool-Care 6MSP Utility/Pool Pump..... 92

DECORATIVE WATER FEATURES

- Pool-Care App-Controlled Multi-Color LED Spillway..... 93-94



MEDITATION FOUNTAINS

- Danner Home Collection Meditation Fountains 97-98

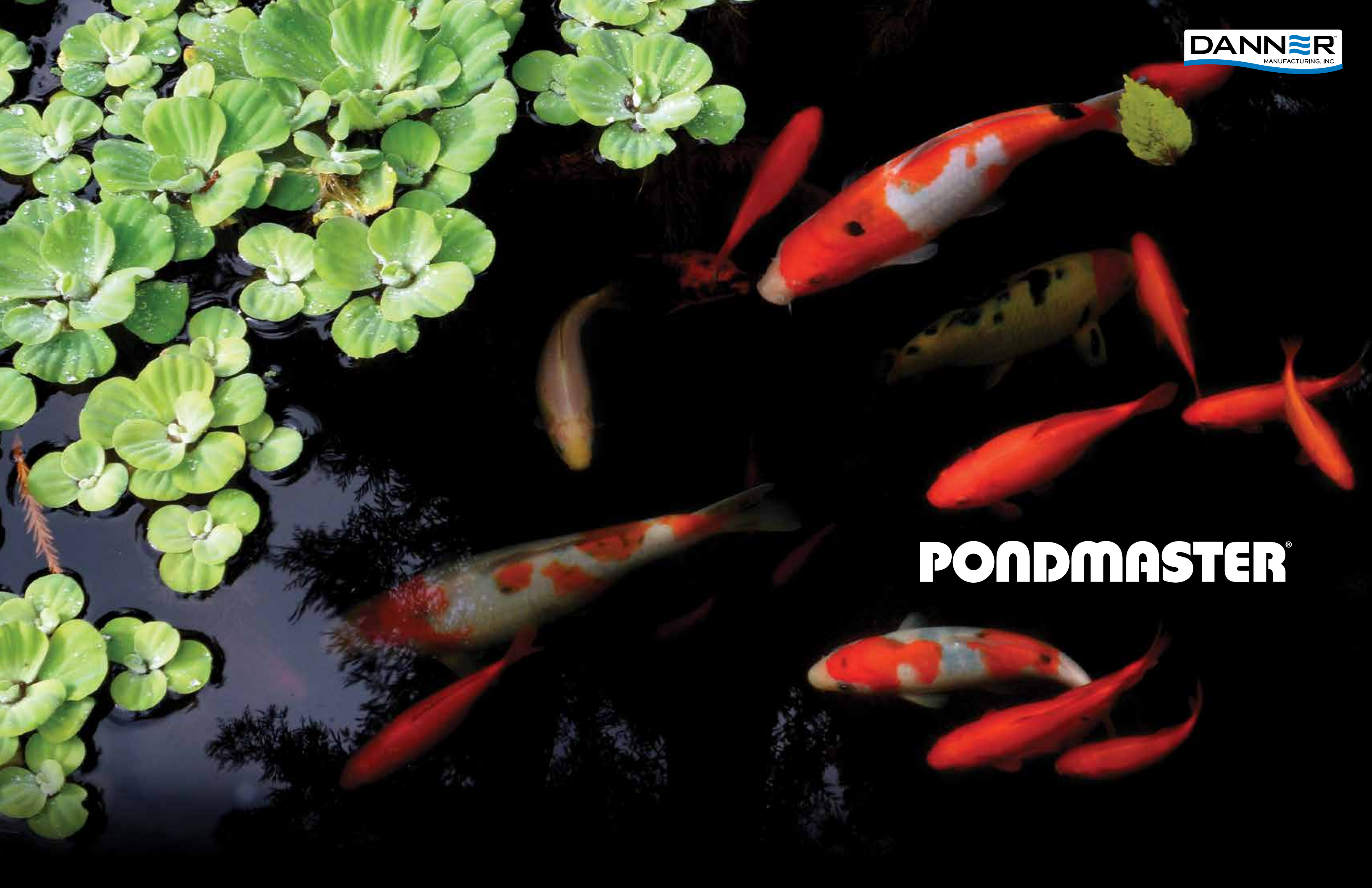

PONDMASTER®

PONDMASTER POND-MAG[®] MAGNETIC DRIVE WATER PUMPS

POND-MAG[®] MAGNETIC DRIVE WATER PUMPS are the choice of consumers and industry professionals nationwide and are engineered to run continuously without seals that can wear out. They are filled with epoxy, not oil, so they cannot leak harmful chemicals into the pond. Pondmaster Pond-Mag[®] Pumps range from 35 to 3600 GPH and are suitable for ponds, statuary, fountains, and aquariums.



THE ANATOMY OF A PONDMASTER POND-MAG[®] MAGNETIC DRIVE WATER PUMP

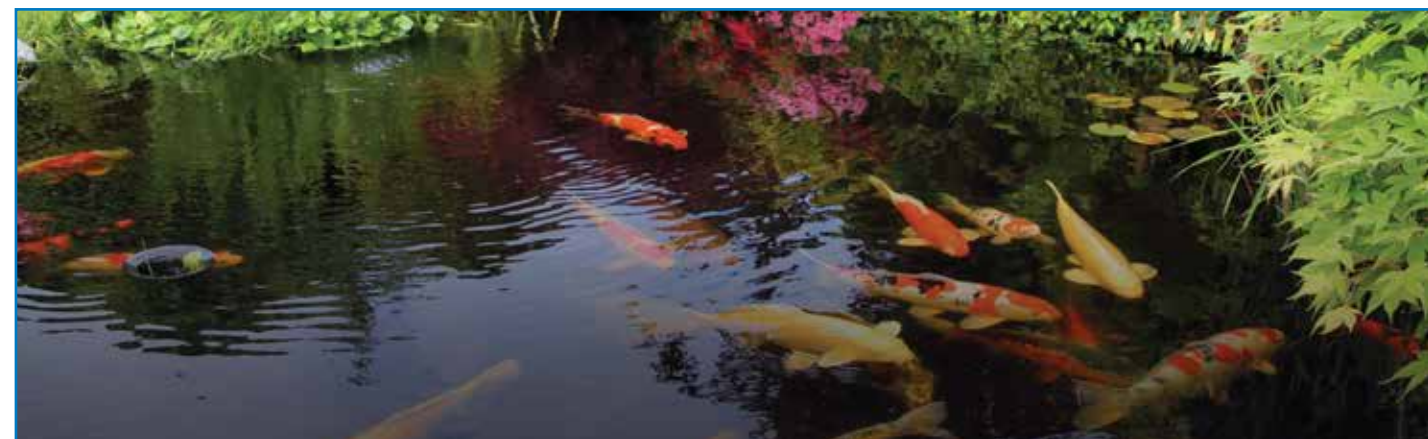
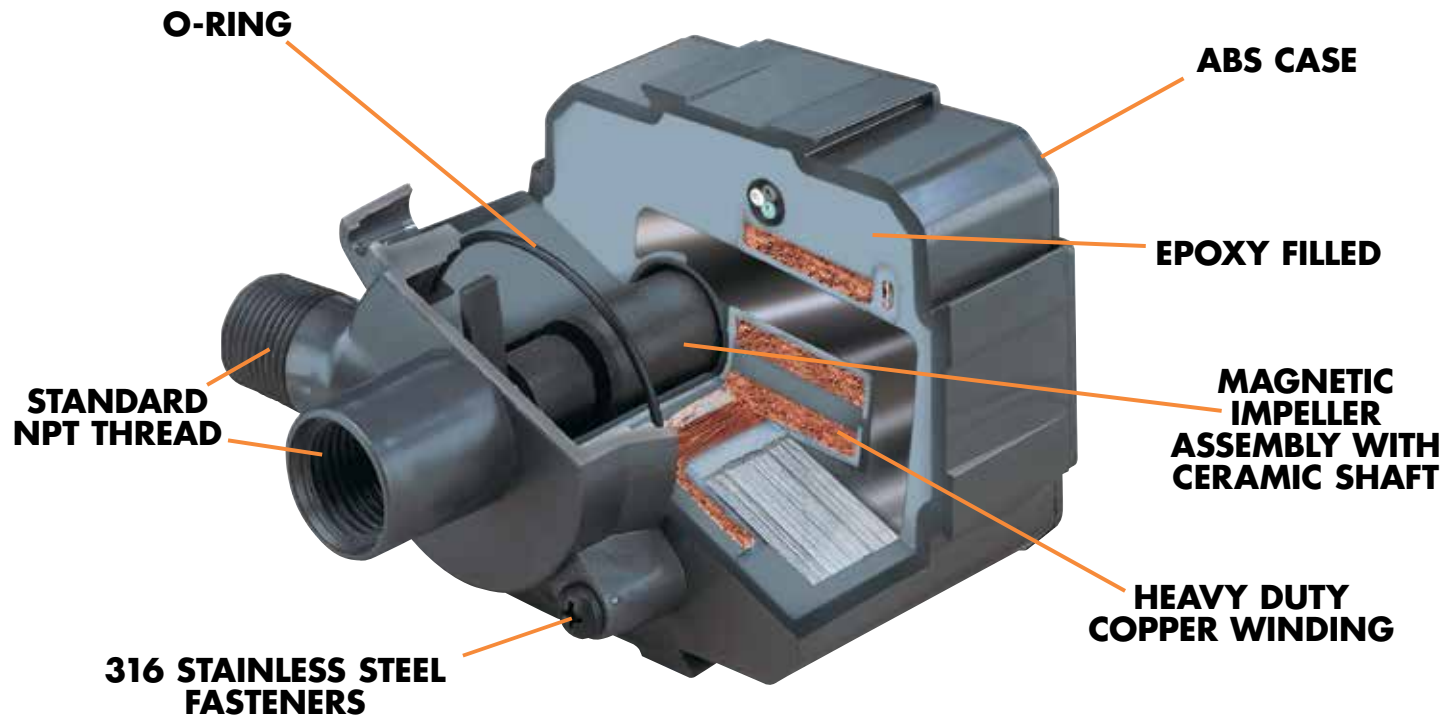

PONDMASTER POND-MAG[®] MAGNETIC DRIVE WATER PUMPS

PONDMASTER

PONDMASTER POND-MAG[®] 250 to 3600 SERIES PUMPS have been designed to handle virtually any application where water has to be moved. They've been fulfilling the needs of professionals and consumers for decades with quiet, efficient and reliable 24/7 performance. They feature a magnet impeller assembly and an epoxy encased power unit ensuring that water never gets contaminated with harmful oils or chemicals. Pondmaster Pond-Mag[®] pumps are perfect for all pond environments.

FEATURES

- 5 Year Limited Warranty
- Rigid Pre-Filter Included
- Ceramic Shaft
- 18' Grounded Power Cord
- Operates Submerged or Inline
- UL/CUL Certified
- Packed 6 per Master Carton (250 to 700)
- Packed 2 per Master Carton (950 to 3600)



PM 700

PM 250 - ITEM# 02522

Max. Watts/Amps	24/0.4
Inlet	1/2" FPT
Outlet	1/2" MPT
Cord Length	18'
Dimensions (L x W x H)	5.0" x 3.8" x 4.2"

PM 500 - ITEM# 02525

Max. Watts/Amps	45/0.9
Inlet	1/2" FPT
Outlet	1/2" MPT
Cord Length	18'
Dimensions (L x W x H)	5.0" x 3.8" x 4.2"



PM 500 shown with Rigid Pre-Filter

PM 350 - ITEM# 02523

Max. Watts/Amps	35/0.6
Inlet	1/2" FPT
Outlet	1/2" MPT
Cord Length	18'
Dimensions (L x W x H)	5.0" x 3.8" x 4.2"

PM 700 - ITEM# 02527

Max. Watts/Amps	70/1.6
Inlet	1/2" FPT
Outlet	1/2" MPT
Cord Length	18'
Dimensions (L x W x H)	5.0" x 3.8" x 4.2"

Model	Item #	Watts	Flow at 1'	Flow at 2'	Flow at 3'	Flow at 4'	Flow at 5'	Flow at 6'	Flow at 7'	Flow at 8'	Flow at 9'	Flow at 10'	Shut-Off (Feet)
PM 250	02522	24	280	230	170	130	65	25	-	-	-	-	6' 5"
PM 350	02523	35	420	375	325	280	235	190	140	90	30	-	10' 4"
PM 500	02525	45	525	450	400	350	300	235	200	150	95	-	10' 6"
PM 700	02527	70	655	605	565	530	450	420	325	275	200	110	11' 8"

PONDMASTER POND-MAG[®] MAGNETIC DRIVE WATER PUMPS

PM 950 - ITEM# 02720

Max. Watts/Amps	93/1.33
Inlet	3/4" FPT
Outlet	3/4" MPT
Cord Length	18'
Dimensions (L x W x H)	5" x 3" x 5.25"



PM 950



PM 1200 - ITEM# 02722

Max. Watts/Amps	110/1.5
Inlet	3/4" FPT
Outlet	3/4" MPT
Cord Length	18'
Dimensions (L x W x H)	6.4" x 3" x 5.25"

PM 1800 - ITEM# 02728

Max. Watts/Amps	145/1.55
Inlet	3/4" FPT
Outlet	3/4" MPT
Cord Length	18'
Dimensions (L x W x H)	6.4" x 3" x 5.25"

PM 2400 - ITEM# 02750

Max. Watts/Amps	237/2.2
Inlet	1" FPT
Outlet	1" MPT
Cord Length	18'
Dimensions (L x W x H)	7.25" x 4.0" x 6"

PM 3600 - ITEM# 02755

Max. Watts/Amps	256/3.0
Inlet	1" FPT
Outlet	1" MPT
Cord Length	18'
Dimensions (L x W x H)	7.25" x 4.0" x 6"



PM 3600



Model	Item #	Watts	Flow at 1'	Flow at 2'	Flow at 3'	Flow at 4'	Flow at 5'	Flow at 6'	Flow at 7'	Flow at 8'	Flow at 9'	Flow at 10'	Flow at 15'	Shut-Off (Feet)
PM 950	02720	93	1010	930	900	840	770	710	650	600	530	475	-	13' 7"
PM 1200	02722	110	1190	1130	1065	940	900	840	795	730	630	570	-	13' 7"
PM 1800	02728	145	1300	1240	1170	1130	1040	1015	925	880	810	775	470	16' 6"
PM 2400	02750	237	2400	2350	2190	2030	1860	1730	1645	1510	1395	1380	830	17' 1"
PM 3600	02755	256	3060	2885	2775	2670	2595	2480	2365	2295	2205	2170	1615	22' 6"

PONDMASTER HYDRO-AIR[®] SUBMERSIBLE WATER & AIR PUMP



THE **PONDMASTER HYDRO-AIR SUBMERSIBLE WATER & AIR PUMP** is a unique patented design that allows water flow and aeration to be produced by one pump. With a dual-ended impeller design, this energy-efficient design fulfills two functions with one product. The pump is completely epoxy-encased so there's never a fear that it will contaminate the water with harmful oils or chemicals.



FEATURES

- One Electrical Outlet needed for both Water and Air
- Custom Diffuser disperses a wide band of Air Bubbles
- Ceramic Shaft
- Aerates Ponds up to 1,000 Gallons
- Can be used in depths up to 2-Feet
- Pumps up to 1400 Gallons per hour
- (2) Pre-Filters Included
- 8 1/4" L x 3 3/4" W x 5 1/2"H without Diffuser (6 1/2" H with Diffuser)
- 18' Grounded Power Cord
- 1 Year Limited Warranty

WATER ON ONE SIDE



OXYGEN ON THE OTHER



HYDRO-AIR SUBMERSIBLE WATER & AIR PUMP ITEM# 02795

- 17 Ft. Shut-Off with 1-1/2" Tubing
- 16 Ft. Shut-Off with 2" Tubing
- 120 Volts AC, 60 HZ, 199 Watts, 3.7 Amps.

ON WATER PUMP SIDE

- 3/4" FPT Inlet
- 3/4" MPT Outlet

ON AIR PUMP SIDE

- Requires 1/2" Flexible PVC Tubing on the Inlet (sold separately)
- Air Diffuser on the Outlet (included)

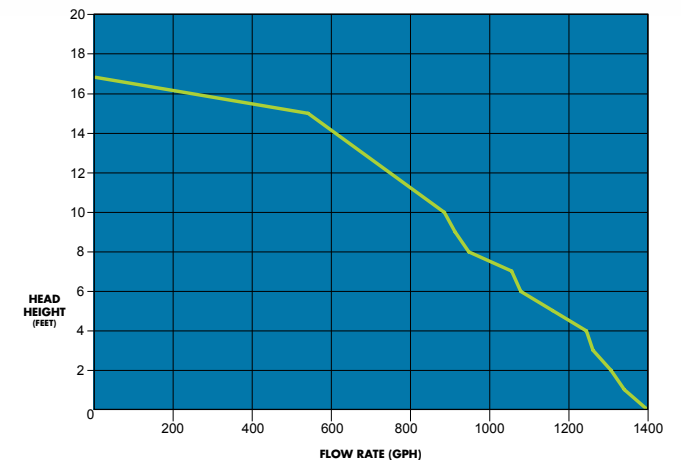

SUBSCRIBE TO OUR YOUTUBE CHANNEL AND VIEW OUR HYDRO-AIR PRODUCT VIDEO!
WWW.YOUTUBE.COM/DANNERMFG

PONDMASTER WATERFALL/SKIMMER PUMPS

PONDMASTER MAGNETIC DRIVE WATERFALL/SKIMMER PUMPS are high capacity pumps designed specifically for use in Skimmers, Waterfalls and Large Pond Installations. These highly efficient units, featuring reliable ceramic bearings deliver up to 3000 GPH; Enough to create a dynamic, attractive waterfall or drive a medium to large size skimmer.

FEATURES

- Designed for Use in Skimmers, Waterfalls and Large Pond Installations
- Powerful, Efficient Magnetic Drive Motor
- Oil-Free / Fish Safe
- Continuous Duty Operation
- Completely Submersible
- Extra-Large, Clog-Resistant Filter Screen
- Back-Flow Check Valve and 1½" Fittings Supplied
- 20' Power Cord with Grounded Plug
- Replacement Impeller Available
- Packed 2 per Master Carton
- 1 Year Limited Warranty

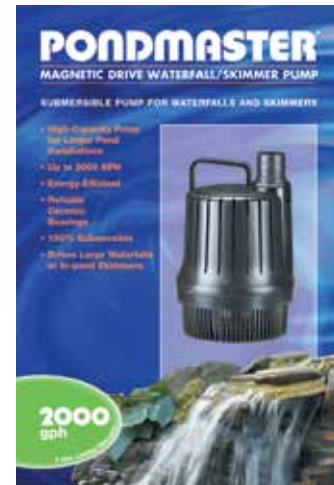

2000 GPH - ITEM# 02650 SUBMERSIBLE WATERFALL PUMP

Max. Flow Rate	2000 GPH
Max. Pumping Height	13'
Max. Watts/Amps	145/2.1
Weight	9 lbs.
Dimensions (L x W x H)	7.5" x 7.5" x 11.25"



3000 GPH - ITEM# 02660 SUBMERSIBLE WATERFALL PUMP

Max. Flow Rate	3000 GPH
Max. Pumping Height	15'
Max. Watts/Amps	250/2.3
Weight	11 lbs.
Dimensions (L x W x H)	7.5" x 7.5" x 11.25"

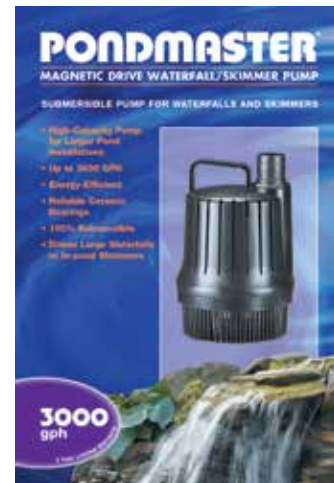

Model	Item #	Watts	Flow at 1'	Flow at 2'	Flow at 3'	Flow at 4'	Flow at 5'	Flow at 6'	Flow at 7'	Flow at 8'	Flow at 9'	Flow at 10'	Shut-Off (Feet)
SWFP 2000	02650	145	1836	1416	1374	1230	1086	1026	942	828	744	654	13'2"
SWFP 3000	02660	250	2022	1938	1866	1782	1644	1560	1470	1356	1242	1110	14'6"

PONDMASTER FOUNTAIN-MAG™ MAGNETIC DRIVE WATER PUMPS

PONDMASTER

THE PONDMASTER FOUNTAIN-MAG™ PUMPS Designed for Fountains, Statuary and Small Ponds with energy-efficient Magnetic Drive Technology. Models 35 and 65 GPH are perfect for table top fountains; Models 65 and 80 GPH are great for small garden fountains, piped statuary and shallow water conditions; Model 190 GPH is suitable for small to medium size fountains, piped statuary and small ponds. Pondmaster Fountain-Mag pumps are a must for any retailer's lineup.

FEATURES

- Built-In Adjustable Flow Control
- Foam Pre-Filter (Not Included in 35 GPH and 65 GPH Models)
- Grounded Power Cords
- Packed 4 Per Master Carton
- 1 Year Limited Warranty on Models 35 GPH Thru 140 GPH
- 5 Year Limited Warranty on Model 190 GPH



MINI 35 GPH ITEM# 02501

Max. Watts/Amps	5.0/0.04
Inlet	NO THREAD
Outlet	½"
Cord Length	6'
Dimensions (L x W x H)	1.9" x 1.4" x 1.69"

For Submersed Use Only



65 GPH FOUNTAIN-MAG ITEM# 02510

Max. Watts/Amps	5.75/0.06
Inlet	NO THREAD
Outlet	5/16" or ½"
Cord Length	6'
Dimensions (L x W x H)	2.5" x 1.8" x 2.8"

For Submersed Use Only



80 GPH FOUNTAIN-MAG ITEM# 02520

Max. Watts/Amps	8.5/0.1
Inlet	NO THREAD
Outlet	3/8" or ½"
Cord Length	6'
Dimensions (L x W x H)	2.9" x 2.2" x 2.7"

For Submersed Use Only

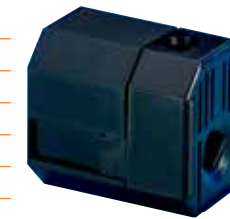

140 GPH FOUNTAIN-MAG ITEM# 02521

Max. Watts/Amps	12.0/0.1
Inlet	NO THREAD
Outlet	3/8" or ½"
Cord Length	6'
Dimensions (L x W x H)	2.9" x 2.2" x 2.7"

For Submersed Use Only



190 GPH FOUNTAIN-MAG ITEM# 02519

Max. Watts/Amps	19.0/0.3
Inlet	3/8" MPT
Outlet	¼"
Cord Length	10'
Dimensions (L x W x H)	2.5" x 1.8" x 2.8"

Use Submersed or In-Line

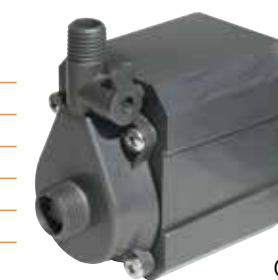

02519 In-line (without cover)



02519 Submersed (with cover)



PUMPING SPECIFICATIONS									
Model	Item #	Watts	Flow at 1'	Flow at 2'	Flow at 3'	Flow at 4'	Flow at 5'	Flow at 6'	Shut-off (Feet)
35 GPH	02501	5.0	22	-	-	-	-	-	2'
65 GPH	02510	5.75	40	-	-	-	-	-	2'
80 GPH	02520	8.5	45	17	-	-	-	-	2' 6"
140 GPH	02521	12.0	120	80	60	40	30	-	6'
190 GPH	02519	19.0	167	140	125	93	68	34	7'

THE FOUNTAIN PUMP FOUNTAIN & STATUARY WATER PUMPS



THE FOUNTAIN PUMP is designed for Fountains, Statuary and Small Ponds with energy-efficient Magnetic Drive Technology.

FEATURES

- Vertical Flow Control Design Increases Flow Range
- Models 70 thru 200 for Submersible Use Only
Models 290 thru 725 for Submersible or In-line Use
- 6' Grounded Power Cord on 70 - 120 GPH Pumps
- 6' or 15' Grounded Power Cord on 200 - 725 GPH Pumps
- 2 Year Limited Warranty

70 GPH FOUNTAIN PUMP - ITEM# 01703

Max. Flow Rate	70 GPH
Max. Pumping Height	2'
Cord Length	6'
Power	115V, 60Hz
Dimensions (L x W x H)	2" x 1 3/4" x 1 3/4"
Includes Tubing Adaptors	1/4" and 1/2"

93 GPH FOUNTAIN PUMP - ITEM# 01707

Max. Flow Rate	93 GPH
Max. Pumping Height	2.5'
Cord Length	6'
Power	115V, 60Hz
Dimensions (L x W x H)	2 5/8" x 1 1/2" x 2 3/8"
Includes Tubing Adaptors	1/4" and 1/2"

120 GPH FOUNTAIN PUMP - ITEM# 01713

Max. Flow Rate	120 GPH
Max. Pumping Height	3'
Cord Length	6'
Power	115V, 60Hz
Dimensions (L x W x H)	2 3/4" x 1 5/8" x 2 1/2"
Includes Tubing Adaptors	1/4" and 1/2"

200 GPH FOUNTAIN PUMP - ITEM# 01717

Max. Flow Rate	200 GPH
Max. Pumping Height	5.5'
Cord Length	6' or 15'
Power	115V, 60Hz
Dimensions (L x W x H)	3 1/8" x 2" x 3"
Includes Tubing Adaptors	1/4" and 1/2"

200 GPH FOUNTAIN PUMP/15' CORD - ITEM# 01719M1

Max. Flow Rate	200 GPH
Max. Pumping Height	5.5'
Cord Length	6' or 15'
Power	115V, 60Hz
Dimensions (L x W x H)	3 1/8" x 2" x 3"
Includes Tubing Adaptors	1/4" and 1/2"

290 GPH FOUNTAIN PUMP - ITEM# 01723

Max. Flow Rate	290 GPH
Max. Pumping Height	6.5'
Cord Length	6' or 15'
Power	115V, 60Hz
Dimensions (L x W x H)	4 5/8" x 3" x 3 1/2"
Inlet Size	1/2" Male NPS
Includes Tubing Adaptors	1/2", 5/8" and 3/4"

400 GPH FOUNTAIN PUMP - ITEM# 01727

Max. Flow Rate	400 GPH
Max. Pumping Height	8.5'
Cord Length	6' or 15'
Power	115V, 60Hz
Dimensions (L x W x H)	4 3/8" x 2 5/8" x 3 1/8"
Inlet Size	1/2" Male NPS
Includes Tubing Adaptors	1/2", 5/8" and 3/4"

530 GPH FOUNTAIN PUMP - ITEM# 01733

Max. Flow Rate	530 GPH
Max. Pumping Height	9'
Cord Length	6' or 15'
Power	115V, 60Hz
Dimensions (L x W x H)	4 1/2" x 2 3/4" x 3 1/4"
Inlet Size	1/2" Male NPS
Includes Tubing Adaptors	1/2", 5/8" and 3/4"

725 GPH FOUNTAIN PUMP - ITEM# 01737

Max. Flow Rate	725 GPH
Max. Pumping Height	12'
Cord Length	6' or 15'
Power	115V, 60Hz
Dimensions (L x W x H)	4 1/2" x 3" x 3 1/2"
Inlet Size	1/2" Male NPS
Includes Tubing Adaptors	1/2", 5/8" and 3/4"

725 GPH FOUNTAIN PUMP/15' CORD - ITEM# 01739

Max. Flow Rate	725 GPH
Max. Pumping Height	12'
Cord Length	6' or 15'
Power	115V, 60Hz
Dimensions (L x W x H)	4 1/2" x 3" x 3 1/2"
Inlet Size	1/2" Male NPS
Includes Tubing Adaptors	1/2", 5/8" and 3/4"

ALSO AVAILABLE AS A
3 TIER FLOOR DISPLAY
ITEM# 22780
OR
COUNTER TOP DISPLAY
ITEM# 22770



Pump	Flow at 0'	Flow at 2'	Flow at 4'	Flow at 6'	Flow at 8'	Shut-Off	Watts	Amps
SP-70	70	-	-	-	-	2'	3W	.03A
SP-93	93	20	-	-	-	2.5'	6W	.07A
SP-120	120	50	-	-	-	3'	6.5W	.08A
SP-200	200	140	85	35	-	5.5'	14W	.19A
SP-290	290	270	205	50	-	6.5'	17W	.24A
SP-400	400	360	285	155	30	8.5'	30W	.45A
SP-530	530	500	420	305	135	9'	50W	.68A
SP-800	725	690	615	515	420	12'	70W	.50A

PONDMASTER HY-DRIVE WATER PUMPS



PONDMASTER ENERGY SAVING HY-DRIVE WATER PUMPS are rugged, powerful and efficient. The compact size makes it ideal to use in pond skimmers or anywhere that space is tight. Available in capacities up to 7600 GPH and are ideal for larger ponds and waterfalls. All pumps come with a full set of fittings and include a free pump bag for extra pump protection.

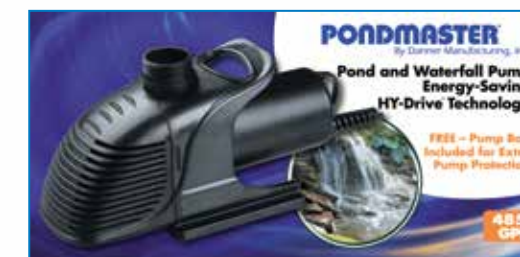

Rotating Connector



1 1/2" and 2" Barbed Fitting



Pump Bag Included

FEATURES

- Powerful Efficient Hybrid Magnetic Induction Motor
- High-Efficiency Vortex Impeller
- Whisper Quiet Continuous Duty Operation
- Oil-Free / Fish Safe
- Convenient Carry Handle
- Submersible or In-line Operation
- Includes Extra Large Clog Resistant Filter Screen
- Threaded Female Couplings and Fittings Included
- 20' Power Cord with Grounded Plug
- Packed 2 per Master Carton
- 3 Year Limited Warranty

1900 GPH - ITEM# 20210

Max. Watts/Amps	93/.78
Inlet	1 1/2"
Outlet	1 1/2"
Shutoff	10'
Dimensions (L x W x H)	9.0" x 4.25" x 6.75"

2550 GPH - ITEM# 20215

Max. Watts/Amps	147/1.25
Inlet	1 1/2"
Outlet	1 1/2"
Shutoff	11' 5"
Dimensions (L x W x H)	9.0" x 4.25" x 6.75"

4850 GPH - ITEM# 20220

Max. Watts/Amps	328/2.76
Inlet	1 1/2"
Outlet	1 1/2"
Shutoff	22' 5"
Dimensions (L x W x H)	10.5" x 4.5" x 7.75"

6100 GPH - ITEM# 20225

Max. Watts/Amps	520/4.39
Inlet	1 1/2"
Outlet	1 1/2"
Shutoff	28'
Dimensions (L x W x H)	10.5" x 4.5" x 7.75"

6600 GPH - ITEM# 20230

Max. Watts/Amps	593/4.94
Inlet	1 1/2"
Outlet	1 1/2"
Shutoff	30' 5"
Dimensions (L x W x H)	10.5" x 4.5" x 7.75"

7600 GPH - ITEM# 20235

Max. Watts/Amps	660/5.5
Inlet	2"
Outlet	1 1/2"
Shutoff	27' 5"
Dimensions (L x W x H)	10.5" x 4.5" x 7.75"

PM NAME	PM ITEM#	Watts	Flow at 1'	Flow at 3'	Flow at 5'	Flow at 7'	Flow at 10'	Flow at 15'	Flow at 20'	Flow at 25'	Flow at 30'	Shut-Off (Feet)
PMHD 1900	20210	93	1710	1325	870	555	-	-	-	-	-	10'
PMHD 2550	20215	147	2380	2010	1490	1045	455	-	-	-	-	11' 5"
PMHD 4850	20220	328	4725	4300	3700	3050	2225	1550	300	-	-	22' 5"
PMHD 6100	20225	520	5750	4725	4175	3450	2400	1625	850	250	-	28'
PMHD 6600	20230	593	6525	6275	5500	4925	4325	3325	2425	1850	550	30' 5"
PMHD 7600	20235	660	7440	7210	6690	6170	5525	3805	2640	1310	-	27' 5"

PONDMASTER CPF SERIES PRESSURIZED FILTERS

THE PONDMASTER COMPACT PRESSURIZED FILTERS are ideal filtering systems for small to medium ponds and water features. They've been designed to reduce required maintenance while establishing a healthy environment for fish and aquatic plants. This integrated system can be conveniently located in or near a pond or patio container. The UV Clarifier models help clear ponds of green water algae.

FEATURES

- Detachable Hose Assembly Module allows Quick Shutoff and Easy Disconnection of Hoses for Faster, Easier Filter Maintenance.
- Large Capacity Housing and Reusable Biological and Mechanical Filtering Material Help Maintain a Healthy Environment for Your Fish and Aquatic Plants
- Biological Media Offers Tremendous Surface Area for Beneficial Bacterial Growth – Never Needs Replacing
- Reusable Foam Filter Pad Provides Mechanical Filtration
- Available UV Clarifier Models Help Reduce Free Floating Algae in Pond Water
- Heavy Duty Weather Resistant ABS Plastic Housing Can Be Buried for Inconspicuous Installation
- Maximum Efficiency and Minimum Power Consumption When Used with Pondmaster Magnetic Drive Pumps
- Ideal for Small to Medium Water Gardens, Barrel/Container Ponds
- Can Also Be Used as a Trickle Filter for Small Waterfalls
- Packed 2 per Master Carton
- 1 Year Limited Warranty

CPF 250 - ITEM# 05410

CPF 250 WITH 13 WATT UV CLARIFIER - ITEM# 05415

Capacity	250 Gallon
Max. Pump Size	500 GPH
*Tubing Size: Inlet	3/4" Inside Diameter
Outlet	3/4" Inside Diameter

CPF 500 - ITEM# 05420

CPF 500 WITH 13 WATT UV CLARIFIER - ITEM# 05425

Capacity	500 Gallon
Max. Pump Size	950 GPH
*Tubing Size: Inlet	3/4" Inside Diameter
Outlet	3/4" Inside Diameter

CPF 1000 - ITEM# 05430

CPF 1000 WITH 11 WATT UV CLARIFIER - ITEM# 05435

Capacity	1000 Gallon
Max. Pump Size	950 GPH
*Tubing Size: Inlet	3/4" Inside Diameter
Outlet	3/4" Inside Diameter

CPF 2000 - ITEM# 05440

CPF 2000 WITH 13 WATT UV CLARIFIER - ITEM# 05445

Capacity	2000 Gallon
Max. Pump Size	1800 GPH
*Tubing Size: Inlet	1" Inside Diameter
Outlet	1" Inside Diameter

*Tubing Sold Separately

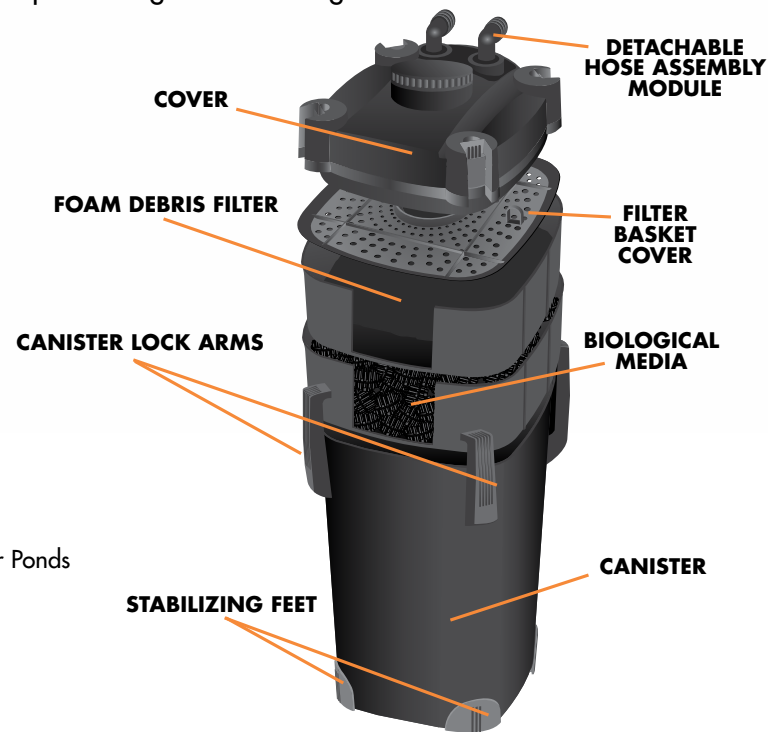

CPF 250 Shown



CPF 500 Shown

CPF SERIES REPLACEMENT MEDIA & PARTS

- Replacement Foam for CPF 250 - Item# 15415
- Replacement Bio-Matrix Ball Media, 40 pcs - Item# 15420
- 13 Watt CPF UV Replacement Lamp - Item# 15455
- CPF UV Quartz Replacement Sleeve - Item# 15460

PONDMASTER CLEARGUARD PRESSURIZED FILTER

PONDMASTER

PONDMASTER CLEARGUARD PRESSURIZED POND FILTER keeps your pond fresh and clean with dual-action biological and mechanical filtration. Clearguard's unique design filters with beneficial bacteria using bio-media while at the same time, mechanically polishing water with a reusable filter pad. This system can be added to any pond and will effectively lower ammonia and nitrite levels in the water. With the available UV Clarifier installed, Clearguard controls green water in the pond while its multi-function valve selector easily clicks into place for convenient filtering, back washing, rinsing and winterizing.

FEATURES

- 7 Functions: Filter, Backwash, Rinse, Winterize, Empty, Circulate and Close
- Reusable Foam Pad Removes Fine Debris and Polishes Water Quickly
- Combination of Biological & Mechanical Media for Maximum Water Clarity and Healthier Ponds
- Available With or Without UV Clarifier (Units with UV Clarifier include ETL Transformer)
- Separate UV Clarifiers are offered in 9W and 18W sizes and can be used for Replacement & Upgrading
- Comes in 2700, 5500, 8000 and 16000 Gallon Sizes
- Includes both PVC Slip Fittings and ABS Barbed Fittings
- Optional Clearguard Backwash Air Kit Available for Ultimate Performance
- 1 Year Limited Warranty



Clearguard Pressurized Filter Shown with a Clearguard Backwash Air Kit Connected, See page 17 for Backwash Air Kit Information.



Clearguard Backwash Air Kits available with or without Air Pump.

PONDMASTER CLEARGUARD PRESSURIZED FILTER

INSIDE THE PONDMASTER CLEARGUARD PRESSURIZED FILTER

PONDMASTER

CLEARGUARD PRESSURIZED FILTERS WITHOUT UV CLARIFIER OPTION

CG2700 - ITEM# 05610 - 2700 GALLON CAP

Weight	17.5 lbs.
L x W x H	17" x 17" x 18.5"
Fittings	1½" PVC Slip & ABS Barb
Maximum Pressure	15 PSI
Recommended Water Pumps	Up to 3000 GPH
Recommended Backwash Air Kit	Small with AP-40, Item #15660

CG5500 - ITEM# 05620 - 5500 GALLON CAP

Weight	22 lbs.
L x W x H	17" x 17" x 28.5"
Fittings	1½" & 2" PVC Slip & ABS Barb
Maximum Pressure	15 PSI
Recommended Water Pumps	Up to 6000 GPH
Recommended Backwash Air Kit	Small with AP-40, Item #15660

CG8000 - ITEM# 05630 - 8000 GALLON CAP

Weight	23 lbs.
L x W x H	17" x 17" x 35"
Fittings	1½" & 2" PVC Slip & ABS Barb
Maximum Pressure	15 PSI
Recommended Water Pumps	Up to 8000 GPH
Recommended Backwash Air Kit	Large with AP-60, Item #15670

CG16000 - ITEM# 05640 - 16000 GALLON CAP

Weight	84 lbs.
L x W x H	23" x 23" x 40"
Fittings	3" PVC Slip & ABS Barb
Maximum Pressure	20 PSI
Recommended Water Pumps	Up to 9000 GPH
Recommended Backwash Air Kit	Large with AP-60, Item #15670

CLEARGUARD PRESSURIZED FILTERS WITH UV CLARIFIER

CGUV2700 - ITEM# 05615 - 2700 GALLON CAP

Weight	18.5 lbs.
L x W x H	17" x 17" x 18.5"
Fittings	1½" PVC Slip & ABS Barb
Maximum Pressure	15 PSI
Recommended Water Pumps	Up to 3000 GPH
Recommended Backwash Air Kit	Small with AP-40, Item #15660

CGUV-5500 - ITEM# 05625 - 5500 GALLON CAP

Weight	23 lbs.
L x W x H	17" x 17" x 28.5"
Fittings	1½" & 2" PVC Slip & ABS Barb
Maximum Pressure	15 PSI
Recommended Water Pumps	Up to 6000 GPH
Recommended Backwash Air Kit	Small with AP-40, Item #15660

CGUV8000 - ITEM# 05635 - 8000 GALLON CAP

Weight	24 lbs.
L x W x H	17" x 17" x 35"
Fittings	1½" & 2" PVC Slip & ABS Barb
Maximum Pressure	15 PSI
Recommended Water Pumps	Up to 8000 GPH
Recommended Backwash Air Kit	Large with AP-60, Item #15670

CGUV16000 - ITEM# 05645 - 16000 GALLON CAP

Weight	86 lbs.
L x W x H	23" x 23" x 40"
Fittings	3" PVC Slip & ABS Barb
Maximum Pressure	20 PSI
Recommended Water Pumps	Up to 9000 GPH
Recommended Backwash Air Kit	Large with AP-60, Item #15670



SUBSCRIBE TO OUR YOUTUBE CHANNEL AND VIEW OUR SERIES OF CLEARGUARD PRODUCT VIDEOS!

WWW.YOUTUBE.COM/DANNERMFG

PONDMASTER CLEARGUARD UV CLARIFIER KIT AND CLEARGUARD BACKWASH AIR KIT

THE PONDMASTER CLEARGUARD UV CLARIFIER KIT adds the benefit of an ultraviolet clarifier to your existing Pondmaster Clearguard Pressurized Pond Filter. UV Clarifiers help control green water and enhance the cleaning action of any Clearguard Pond Filter (maximum of 2 UV Clarifiers can be placed in any Clearguard unit.)

FEATURES

- UV Lamp
- High Quality Quartz Sleeve
- ETL Listed Transformer with 20' Power Cord

9 WATT UV CLARIFIER KIT - ITEM# 15810

For use with Pondmaster Clearguard Models 2700 and 5500

18 WATT UV CLARIFIER KIT - ITEM# 15820

For use with Pondmaster Clearguard 5500, 8000, and 16000 M



THE PONDMASTER CLEARGUARD BACKWASH AIR KIT lets you achieve the ultimate back washing performance for your filter. Simply connect the Air Kit to the bottom of your Clearguard Pressurized Pond Filter and the Backwash Air Kit will quickly loosen pond waste in the filter by agitating the biological media.

KIT INCLUDES

- Pondmaster Air Pump
- Shut Off Valve
- Vinyl Tubing
- Clamps & Appropriate Fittings

SMALL BACKWASH AIR KIT - ITEM# 15660

- Use with the Pondmaster Clearguard Models 2700 and 5500
- Supplied with AP-40 Air Pump

LARGE BACKWASH AIR KIT - ITEM# 15670

- Use with the Pondmaster Clearguard Models 8000 and 16000
- Supplied with AP-60 Air Pump

BACKWASH KIT WITHOUT AIR PUMP - ITEM# 15675

- Use with all Pondmaster Clearguard Models 2700, 5500, 8000 and 16000



Small Backwash Air Kit
Item# 15660 shown



Clearguard Backwash Air Kit with Air Pump shown connected to a Clearguard Pressurized Filter



PONDMASTER CLEARGUARD ACCESSORIES

CLEARGUARD UV SLEEVES

9W REPLACEMENT UV SLEEVE - ITEM# 15812

For use with Clearguard 2700 Filter
• Packed 4 Per Master Carton

18W REPLACEMENT UV SLEEVE - ITEM# 15822

For use with CLEARGUARD 5500, 8000 and 16000 Filters
• Packed 4 Per Master Carton

CLEARGUARD UV BULBS

9W REPLACEMENT UV BULB - ITEM# 15615

For use with Clearguard 2700 Filter
• Packed 4 Per Master Carton

18W REPLACEMENT UV BULB - ITEM# 15625

For use with Clearguard 5500, 8000 and 16000 Filters
• Packed 4 Per Master Carton

CLEARGUARD BIOMATRIX MEDIA

REPLACEMENT BIOMATRIX MEDIA - ITEM# 15650

For use with all Clearguard Filters
• 300 Bio-Balls Per Bag; Packed 4 Per Master Carton

CLEARGUARD FOAM FILTER PADS

REPLACEMENT FOAM FILTER PAD - ITEM# 15640

For use with Clearguard 2700, 5500 and 8000 Filters
• Packed 4 Per Master Carton

REPLACEMENT FOAM FILTER PAD - ITEM# 15645

For use with Clearguard 16000 Filter
• Packed 4 Per Master Carton

CLEARGUARD REPLACEMENT FITTINGS

1.5" INLET FITTING KIT - ITEM# 15710

For use with 2700, 5500 and 8000 Filters
• Packed 4 Per Master Carton

2" INLET FITTING KIT - ITEM# 15720

For use with 5500 and 8000 Filters
• Packed 4 Per Master Carton

1.5" WASTE-OUTLET FITTING KIT - ITEM# 15715

For use with 2700, 5500 and 8000 Filters
• Packed 4 Per Master Carton

2" WASTE-OUTLET FITTING KIT - ITEM# 15725

For use with 5500 and 8000 Filters
• Packed 4 Per Master Carton

3" INLET-OUTLET-WASTE FITTING KIT - ITEM# 15730

For use with 16000 Filter
• Packed 4 Per Master Carton

FOR A COMPLETE LIST OF CLEARGUARD REPLACEMENT PARTS, VISIT WWW.DANNERMFG.COM

PONDMASTER



PONDMASTER ULTRAVIOLET CLARIFIERS

PONDMASTER ULTRAVIOLET CLARIFIERS Can be used either fully submerged or out of the water and feature a glowing monitor Halo Ring that shows the clarifier is working submerged or in-line. The soft blue Halo is visible during the day or at night from any angle, but does not detract from the beauty of your pond. Pondmaster Ultraviolet Clarifiers are designed to handle the clarifying needs of ponds up to 6,000 gallons.

FEATURES

- Vortex Flow Design Exposes Water Longer to Ultraviolet Light
- Fully Submersible
- Includes Transformer and 18' Grounded Power Cord
- Black Color is Unobtrusive Whether Used In or Out of the Water

10 WATT SUBMERSIBLE ULTRAVIOLET CLARIFIER ITEM# 02910

Suitable for small Ponds up to 1500 Gallons Using Pumps up to 700 GPH

- One Glowing Monitor Halo Ring™
- Complete with 9000 Hour, Long Life 10 Watt Lamp and Water Tight Quartz Sleeve
- Inlet/Outlet Size: 3/4" Barbed 3/4" Barbed Fitting on Inlet and Outlet
- Packed 2 Per Master Carton
- 1 Year Limited Warranty



02910



The unique vortex flow design of the Ultraviolet Clarifier increases water contact time with the ultraviolet light, while the slim diameter lamp allows the water to get closer to the intense UV rays.



ULTRAVIOLET CLARIFIER REPLACEMENT PARTS

Individually Packed, Shipped 4 Per Master Carton

ITEM# 12971	9000 Hour, 10 Watt Lamp
ITEM# 12972	9000 Hour, 20 Watt Lamp
ITEM# 12974	9000 Hour, 40 Watt Lamp
ITEM# 12981	10 Watt Quartz Sleeve
ITEM# 12982	20 Watt Quartz Sleeve
ITEM# 12984	40 Watt Quartz Sleeve

20 WATT SUBMERSIBLE ULTRAVIOLET CLARIFIER ITEM# 02920: WITH 1" BARBED INLET/OUTLET ITEM# 02925: WITH 1 1/2" MNPT THREADED INLET/OUTLET

Suitable for medium Ponds up to 3000 Gallons Using Pumps up to 1800 GPH

- Two Glowing Monitor Halo Rings™
- Complete with 9000 Hour, Long Life 20 Watt Lamp and Water Tight Quartz Sleeve
- Inlet/Outlet Size for Item# 02920: 1" Barbed
- Inlet/Outlet Size for Item# 02925: 1 1/2" Male Threaded Fittings with 1 1/2" Female Barbed Elbows (Included)
- Packed 2 Per Master Carton
- 1 Year Limited Warranty



02920

Now Available with 1 1/2" Male Threaded Fittings with 1 1/2" Female Barbed Elbows.



02925

40 WATT SUBMERSIBLE ULTRAVIOLET CLARIFIER ITEM# 02940

Suitable for large Ponds up to 6000 Gallons

Using Pumps up to 3000 GPH

- Three Glowing Monitor Halo Rings™
- Complete with 9000 Hour, Long Life 40 Watt Lamp and Water Tight Quartz Sleeve
- 1 1/2" Male Threaded Fittings with 1 1/2" Female Barbed Elbows Included
- Packed 2 Per Master Carton
- 1 Year Limited Warranty



02940

PONDMASTER FILTRATION SYSTEMS

PONDMASTER

THESE INNOVATIVE LOW PROFILE FILTERS are designed to be unobtrusive in the bottom of the pond and its large surface area means less frequent cleaning. More than one filter can be connected to a pump using a tee fitting and offer mechanical, chemical and biological filtration. Dual filter elements offer particle filtering and chemical filtration of certain harmful compounds. The filter media is easily rinsed or changed and less time consuming than many similar filters of its kind.

PM 500 - ITEM# 02205

- For Use with Pumps Up To 500 GPH
- Snap-in Filter Cartridge for Quick Media Replacement
- Quick Disconnect for Easy Removal from Pump
- 9" x 9" Filter Box with Removable Filter Media
- For In-Pond Use Only
- Packed 4 Per Master Carton



02205



PM 1000 - ITEM# 02211

- For Use with Pumps Up To 1000 GPH
- 12" x 12" Filter Box with Locking Handle
- Carbon and Polyester Media for Mechanical/Biological/Chemical Filtration
- Connects to Intake Side of Pump
- Complete with 3/4" I.D. Tubing and Fittings
- Connect More than One to a Pump
- For In-Pond Use Only
- Packed 4 Per Master Carton



02211



PM 2000 - ITEM# 02200

- For Use with Pumps Up To 2000 GPH
- 12" x 24" Filter Box with Carrying Handle
- Polyester and Biological Foam Inserts, Suitable to Hold Other Biological Media
- Connects to Intake Side of Pump
- Complete with 1" I.D. Tubing and Fittings
- Connect More than One to a Pump
- For In-Pond Use Only
- Packed 2 Per Master Carton



02200



PONDMASTER POND KITS

PONDMASTER POND KITS are a great and practical way to start the excitement of water gardening. These kits are designed to encourage sales by easily matching pumps with filters, including fountain heads with tubing and fittings where necessary. Can be used with rigid or flexible liners.

PMK 190 - ITEM# 02019

Suitable for small to medium Ponds and Containers

- 190 GPH Pump (CUL/UL Listed)
- Deluxe Filter System
- Bell Fountain Head
- Mechanical and Biological Filtration
- Packed 4 Per Master Carton



02019

PMK 1250 - ITEM# 02212

Suitable for small to medium Ponds up to 600 Gallons

- 250 GPH Pump (CUL/UL Listed)
- Deluxe Filter System (PM1000)
- Bell and Adjustable Fountain Heads
- Tubing and Fittings
- Mechanical, Biological and Chemical Filtration
- Packed 2 Per Master Carton



02212

PMK 1350 - ITEM# 02213

Suitable for medium Ponds up to 800 Gallons

Same as PMK 1250 but with a 350 GPH Pump (CUL/UL Listed)

PMK 1500 - ITEM# 02215

Suitable for medium Ponds up to 1000 Gallons

Same as PMK 1250 but with a 500 GPH Pump (CUL/UL Listed)

PMK 1700 - ITEM# 02217

Suitable for medium to large Ponds up to 1250 Gallons

Same as PMK 1250 but with a 700 GPH Pump (CUL/UL Listed)

WATERSCAPING DOES NOT NEED TO BE LIMITED TO INGROUND PONDS.

Create additional sales by offering kits designed for use with patio ponds and tub gardens. Perfect for the individual who does not desire a full size pond and this kit is specially suited for small areas or for use indoors. Components are sized to work together ensuring customer satisfaction.

190 GPH PUMP AND FOUNTAIN KIT ITEM# 02273

Suitable for small Barrels and Containers

- 190 GPH Pump (CUL/UL Listed)
- Bell Fountain Head
- Block Foam Filter
- Packed 4 Per Master Carton



02273

PONDMASTER AIR PUMPS

PONDMASTER

PONDMASTER AP-SERIES AIR PUMPS have been designed to satisfy the requirements of a multitude of water-related applications. All AP-Series air pumps operate on standard 115V electric and come with a 6' power cord. The oil-less motor is designed to operate efficiently and save energy. For outdoor applications, it is recommended that the unit be enclosed to protect it from the elements.

FEATURES

- Energy Efficient Motor
- High Volume with Steady Air Flow
- Air Manifold (included)
- Quiet Operation
- No Lubrication Necessary
- Packed 2 Per Master Carton
- Easy to Use
- Single Outlet Discharge
- 1 Year Limited Warranty



AP-20

ITEM# 04520

Air Volume	1700 cu.in/min
Maximum Water Depth	7'
Noise Level	40 dba
Watts	20
Weight	5 lbs
Air Manifold Outlets	6
Pressure	4.0 psi
Liters	28 L/min.
Dimensions (L x W x H)	8 1/2" x 5 1/2" x 6"
Cord Length	6'

Note: Can Accept 5/8" I.D. Tubing to Extend Distance between Air Pump and Manifold

AP-60

ITEM# 04560

Air Volume	5500 cu.in/min
Maximum Water Depth	10'
Noise Level	45 dba
Watts	60
Weight	14 lbs
Air Manifold Outlets	14
Pressure	5.66 psi
Liters	90 L/min.
Dimensions (L x W x H)	10" x 7 1/2" x 8 1/2"
Cord Length	6'

Note: Can Accept 3/4" I.D. Tubing to Extend Distance between Air Pump and Manifold

AP-40

ITEM# 04540

Air Volume	2900 cu.in/min
Maximum Water Depth	9.6'
Noise Level	40 dba
Watts	40
Weight	9 lbs
Air Manifold Outlets	12
Pressure	4.85 psi
Liters	47 L/min.
Dimensions (L x W x H)	9 5/8" x 6 5/8" x 7"
Cord Length	6'

Note: Can Accept 5/8" I.D. Tubing to Extend Distance between Air Pump and Manifold

AP-100

ITEM# 04580

Air Volume	9150 cu.in/min
Maximum Water Depth	11.5'
Noise Level	45 dba
Watts	100
Weight	16.5 lbs
Air Manifold Outlets	33
Pressure	6.53 psi
Liters	150 L/min.
Dimensions (L x W x H)	11 3/4" x 8" x 8 7/8"
Cord Length	6'

Note: Can Accept 3/4" I.D. Tubing to Extend Distance between Air Pump and Manifold



AP-20 POND AERATION KIT - ITEM# 04511

- Aerates Ponds up to 2,000 Gallons
- Provides Vital Oxygen to Your Fish and Plants
- Easy-to-Install Kit Contains Everything You Need to Aerate Your Pond
- Improves Overall Pond Water Quality

KIT INCLUDES

- (1) AP-20 Air Pump
- (1) 6 Port Manifold
- (6) 4" Air Stones
- (3) 16' Sections of Air Line Tubing



FOR A COMPLETE LIST OF REPLACEMENT DIAPHRAGM KITS AND MANIFOLDS VISIT WWW.DANNERMFG.COM

LIFE INSURANCE FOR YOUR PUMP!

PONDMASTER PUMPGUARD™ is what the industry has been waiting for... An easy maintenance solution to keep water pumps running like new. Pumpguard™ quickly cleans calcified, dirty pumps within minutes and comes in a convenient Impeller Treatment size or two Soak/Dunk Treatment sizes*. Danner recommends consumers to use Pumpguard™ every six months to insure proper operation of their pumps.

FEATURES & BENEFITS

- Instantly Loosens Mineral Scale, Lime, Rust and other Detritus from Pond Water Pumps
- Keeps Your Pump Operating Properly and Efficiently
- Fast and Easy to Use
- Biodegradable

DIP/SOAKING TREATMENT (32 OZ or 1 GAL):

- Pour Pumpguard™ into a plastic container
- Remove all matter from the exterior surface of the pump
- Soak in Pumpguard™
- Let sit for 3-5 minutes
- Rinse with water
- Return pump back to your desired location

IMPELLER TREATMENT (4 OZ.):

- Position the inlet portion of the pump vertically
- Slowly fill the volute (inlet) with Pumpguard™
- Let sit for 3-5 minutes
- Rinse with water
- Return pump back to your desired location

PONDMASTER PUMPGUARD™ 4 OZ. - ITEM# 03905

Packed 12 per Master Carton

PONDMASTER PUMPGUARD™ 32 OZ. - ITEM# 03907

Packed 6 per Master Carton

PONDMASTER PUMPGUARD™ 1 GALLON BOTTLE - ITEM# 03909

Packed 4 per Master Carton



*Not for use on aluminum, magnesium or Air Stones.

POND-CLEAN READY-TO-USE CLEANER FOR POND EQUIPMENT AND SURFACES.

Pond-Clean is a biodegradable, safe cleaner formulated to rapidly dissolve all types of mineral scale, lime and rust from equipment used in ponds. Safe for use with plastic, ceramic, rubber, PVC, titanium, copper, nickel and short-term use with stainless steel.* Pond-Clean can be used to thoroughly clean an entire Pond after all inhabitants are removed prior to use and any spent cleaner is thoroughly mixed with water. Everything must be rinsed and flushed before returning Inhabitants.

FEATURES & BENEFITS

- Instantly Loosens Mineral Scale, Lime, Rust and other Detritus from Pond Pumps, Equipment and Surfaces
- Effectively Cleans All of the Surfaces of Your Pumps and Pond Equipment
- Fast and Easy to Use
- Biodegradable

PONDMASTER POND-CLEAN 16 OZ. TRIGGER SPRAY - ITEM# 03951

PONDMASTER POND-CLEAN 32 OZ. TRIGGER SPRAY - ITEM# 03953

PONDMASTER POND-CLEAN 32 OZ. BOTTLE - ITEM# 03955

PONDMASTER POND-CLEAN 1 GALLON BOTTLE - ITEM# 03957

*Not for use on aluminum, magnesium or Air Stones.



PONDMASTER KOI FOOD

2 LB. PONDMASTER COLOR & GROWTH DIET KOI FOOD - ITEM# 03720

- 40% Protein for Rapid Fish Growth
- Made with Spirulina to Enhance Color
- Perfect for Growing Show Quality Koi

2 LB. PONDMASTER STAPLE DIET KOI & GOLDFISH FOOD - ITEM# 03725

5 LB. PONDMASTER STAPLE DIET KOI & GOLDFISH FOOD - ITEM# 03730

- Balanced Diet for Everyday Feeding
- Softens Fast for Easy Digestion
- Great for All Pond Fish



PONDMASTER WATER TREATMENTS



INTRODUCING PONDMASTER ALGAECIDE. Pondmaster Algaecide is an EPA registered algaecide to control active algae blooms in ponds, aquariums and fountains. Excessive algae growth is both unattractive/hazardous to fish & plant life. Pondmaster Algaecide is used to control green water, string or hair algae and blanketweed. Once pond algae growth is under control, weekly doses of Pondmaster Algaecide will control algae growth and reduce pond maintenance. Pondmaster Algaecide will not harm fish or ornamental plants when used as directed with vigorous aeration.

FEATURES

- Stops Algae Growth
- Controls String Algae
- No More Green Water
- Safe for Fish, Plants and Wildlife



PONDMASTER ALGAECIDE
1 PT. 16 OZ. (473 ML)
ITEM# 03940

- Treats 5,760 Gallons (21,804 L)



PONDMASTER ALGAECIDE
1 QT. 32 OZ. (946 ML)
ITEM# 03941

- Treats 11,356 Gallons (42,942 L)



PONDMASTER ALGAECIDE
1/2 GAL. 64 OZ. (1,893 ML)
ITEM# 03942

- Treats 23,040 Gallons (87,216 L)



PONDMASTER WATER TREATMENTS

PONDMASTER

PONDMASTER WATER TREATMENTS contain top-quality, specially blended formulas that promote the health and beauty of any pond. Pondmaster offers a full-range of treatments that help consumers easily choose the right product to obtain proper water quality.

PONDMASTER FOUNTAIN CLEAR 8 OZ. - ITEM# 03911

- Specially Formulated to Keep Fountain and Statuary Water Clear
- Uses Waste-Digesting Bacteria and Enzymes
- Helps Control Lime Deposits and Foaming
- Reduces Filter Clogging and Maintenance
- Safe for Fish, Plants and Wildlife
- Treats 160 Gallons

PONDMASTER NO-SLUDGE POWDER WITH BARLEY 12 OZ. - ITEM# 03972

- Digests Leaves and Organic Debris Quickly
- Barley Maintains Water Clarity
- Increases Oxygen Levels in Pond Water
- Improves Water Quality
- Safe for Fish, Plants and Wildlife
- Treats 6,000 Gallons

PONDMASTER WATERFALL CLEANER 20 OZ. - ITEM# 03973

- Quickly Cleans Pond Waterfalls and Rocks
- Power of Oxidation Removes Organic Debris
- Improves Filter Functioning
- Increases Pond Oxygen Levels
- Safe for Fish, Plants and Wildlife

PONDMASTER WATER CONDITIONER PLUS 16 OZ. - ITEM# 03970

- Reduces Fish Stress
- Replenishes Fish Slime Coat and Promotes Healing
- Power of Aloe Vera and Vitamin E
- Makes Tap Water Safe for Fish Instantly
- Removes Chlorine, Chloramines and Heavy Metals
- Treats 1,920 Gallons

PONDMASTER NO-SLUDGE 16 OZ. - ITEM# 03928

- Breaks Down Dead Algae, Organics and Pond Sludge
- Improves Water Quality and Clarity
- Helps Reduce Ammonia, Nitrite and Nitrates
- Increases Oxygen Levels in Pond Water
- Safe for Fish, Plants and Wildlife
- Treats 4,000 Gallons

PONDMASTER DE-CLOR AND AMMONIA REMOVER 16 OZ. - ITEM# 03971

- Instantly Detoxifies Ammonia, Nitrite and Nitrate
- Instantly Removes Chlorine and Chloramine
- Detoxifies Heavy Metals
- Improves Gill Function in Pond Fish
- Safe for Fish, Plants and Wildlife
- Treats 1,920 Gallons

PONDMASTER POND BLUE DYE 8 OZ. - ITEM# 03715

- Tints Water a Brilliant Blue
- Keeps Pond Water Clear & Shaded
- Helps Maintain Water Clarity
- Safe for Fish, Plants and Wildlife
- Treats 4,000 Gallons

PONDMASTER pH DOWN 16 OZ. - ITEM# 03936

- Fast-Acting Formula that Safely Decreases pH in Pond Water
- Long-Lasting Formula to maintain desired pH
- Safe for Fish, Plants and Wildlife

PONDMASTER pH UP 16 OZ. - ITEM# 03938

- Fast-Acting Formula that Safely Increases pH in Pond Water
- Long-Lasting Formula to maintain desired pH
- Safe for Fish, Plants and Wildlife

PONDMASTER CLARIFIX™ WATER CLARIFIER 16 OZ. - ITEM# 03710

- Cleans & Clears Pond Water in as Little as 24 Hours
- Maintains Crystal Clear Pond Water
- Improves Filter Efficiency
- Safe for Fish, Plants and Wildlife
- Treats 4,800 Gallons



PONDMASTER DISAPPEARING FOUNTAIN BASIN AND PONDMASTER FOUNTAIN HEAD KITS

PONDMASTER DISAPPEARING FOUNTAIN BASIN - ITEM# 22570

- Includes 2'x2' Basin, Grating, Plastic Mesh Screen and PVC Support Insert (Does not Include Pottery, Pump or Decorative Stone)
- Easy to Install
- Strong and Durable
- Install Basin In-Ground, Semi In-Ground or Above Ground



PONDMASTER FOUNTAIN HEADS

VARIABLE FOUNTAIN HEAD KIT - ITEM# 02077

Suitable for Pondmaster 190 - 700 GPH Pumps

- Add an Exotic Look to any Ordinary Pond
- Easily Adapts to Pumps with 1/4" and 1/2" NPT Male Outlet
- Packed 6 Per Master Carton

BELL FOUNTAIN HEAD KIT - ITEM# 02088

Suitable for Pondmaster 250 - 700 GPH Pumps

- Large Adjustable Bell (Mushroom) Pattern
- Includes Two 7" Extensions and Pump Adapter
- Packed 6 Per Master Carton

MINI BELL FOUNTAIN HEAD KIT - ITEM# 02089

Suitable for Pondmaster 80 - 190 GPH Pumps

- Small Adjustable Bell (Mushroom) Pattern
- Includes Two 7" Extensions
- Packed 6 Per Master Carton



PONDMASTER LED LIGHTED SPILLWAY

PONDMASTER LED LIGHTED SPILLWAY is a self-contained LED Spillway that is designed specifically for Waterfalls, Inground Pools, Retaining Walls and many other applications where you desire the beauty of running waterfalls. It features a low energy 3-Watt LED Light Bar that has a brilliant blue colored water feature.

PONDMASTER LED LIGHTED SPILLWAY - ITEM# 03755

- Designed for Self-Contained Waterfalls, Hardscapes, Inground Pools, Retaining Walls and Many other Applications
- Brilliant Blue Colored Water Feature
- Includes a 3/4" to 1-1/4" Stepped Barbed Fitting
- Bottom Mount Connection
- Interior Baffling System that Produces a Single, Lighted Water Sheet
- 12" Wide Spillway with Reinforced Opening with 5" Lip Extension
- 12 Volt Transformer is Outdoor Rated and Listed to US and Canadian ETL Standards
- 33' Power Cord
- Low Energy 3-Watt LED Light Bar
- Recommended Pump Size: 1000 GPH
- 1 Year Limited Warranty
- Packed 4 Per Master Carton

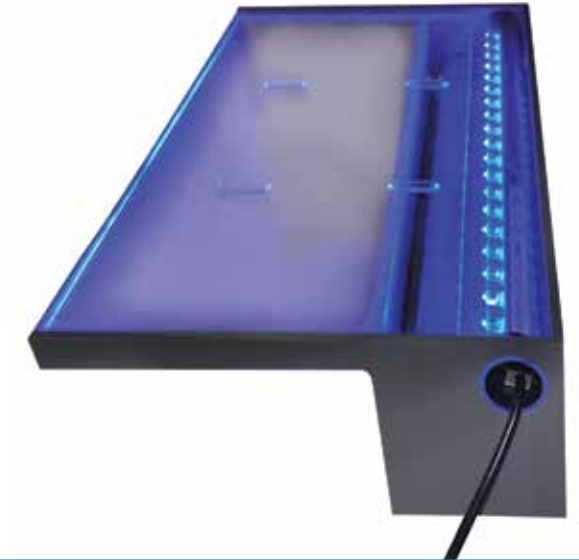

Decorative Hardscapes



Inground Pools

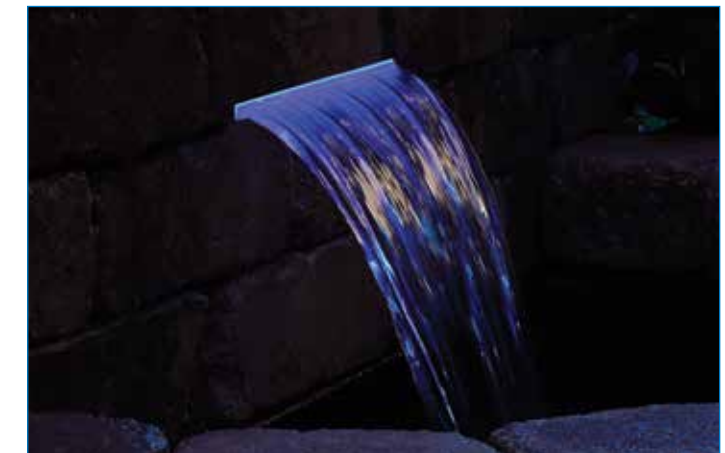

Ponds

PONDMASTER LED LIGHT RING KITS AND PONDMASTER LED LIGHTS

IT'S SHOW TIME with the LED light ring/fountainhead pump accessory. Attach to your pump, wait until dark and watch as your water garden is transformed with this spectacular, brightly lit Fleur-de-lis display.

FEATURES

- Adapts to Pumps with 1/2" or 3/4" Threaded Outlets
- Included Diverter Allows for a Second Feature and Controls Fountain Spray Height
- Creates a Dramatic Nighttime Water Feature
- Watertight, Safe Low Voltage Operation
- Energy Saving 18 LED Light Ring
- UL Listed 12 Volt Transformer with 24' Power Cord
- Packed 4 Per Master Carton
- 1 Year Limited Warranty



18 LED LIGHT RING WITH FOUNTAINHEAD - ITEM# 02180

For use with 250 GPH to 950 GPH Pumps

- Adapts to Pumps with 1/2" or 3/4" Threaded Outlets
- Included Diverter Allows for a Second Feature and Controls Fountain Spray Height



24 LED LIGHT RING WITH FOUNTAINHEAD - ITEM# 02185

For use with 950 GPH to 1800 GPH Pumps

- Adapts to Pumps with 3/4" or 1" Threaded Outlets
- Included Diverter Allows for a Second Feature & Controls Fountain Spray Height



1 LED POND LIGHT WITH PHOTOSENSOR AND TRANSFORMER - ITEM# 02387

3 LED POND LIGHT(S) WITH PHOTOSENSOR AND TRANSFORMER - ITEM# 02389

- Illuminate Ponds, Paths, Walkways or Outdoor Statuary
- UV Protective and Impact-Resistant Polycarbonate Lenses
- High Brilliance 2.0 W LED
- Interchangeable Colored Discs
- Adjustable-Angle Light on Weighted Base
- Low Voltage Operation
- Waterproof Seals on Lamp Housing for Safe-Underwater Operation
- 20' Power Cord
- 12 Volt Transformer is Listed to US and Canadian ETL Standards
- Photosensor Automatically Turns Lights On and Off at Dusk & Dawn
- 1 Year Limited Warranty



02387



02389

PONDMASTER SPOUTING POND STATUES

PONDMASTER

FEATURES

- Creates a Beautiful and Lively Water Action for Ponds and Water Features
- Handcrafted in Cast Resin
- Aerates Water for a Healthier Pond
- Coated Brass Barbed Fitting
- Accents Your Pond and Natural Landscape
- Easy Hook up to a Submersible Pump
- Accepts 1/2" Flexible Tubing (sold separately)

SPOUTING FROG POND STATUE - ITEM# 03765

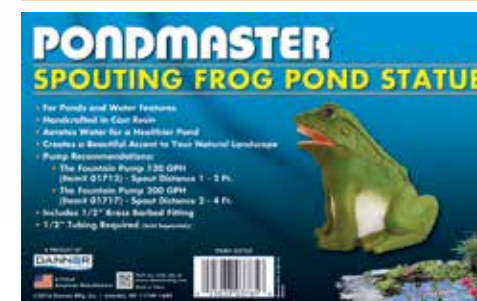

Single connection from Solid brass barbed fitting to spout which eliminates any chance of internal leakage

SPOUTING FISH POND STATUE - ITEM# 03770



SPOUTING TURTLE POND STATUE - ITEM# 03775

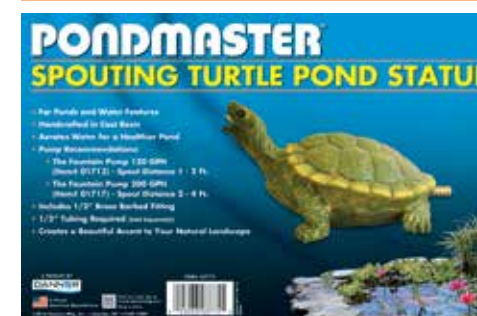

PONDMASTER DE-ICER, FLOATING POND THERMOMETER, AIR DIFFUSERS AND AQUATIC PLANT BASKET

POND DE-ICER - ITEM# 02175

The Floating Winter Pond De-Icer is for use in those colder locations where winter temperatures result in significant or long-term icing of Pond surfaces.

- 120 Watts of Heating Power
- Energy Efficient
- Fixed Thermostatic Control Reduces Heating Time & Saves Electricity
- Internal Electronics Epoxy Sealed for Watertight Protection
- Made from Rugged, High Impact ABS Plastic
- 18' Power Cord
- Will Not Harm Flexible Liners or Pre-Formed Ponds
- Packed 4 Per Master Carton
- 1 Year Limited Warranty



FLOATING POND THERMOMETER - ITEM# 02399

For use in all Outdoor Pond and Water Gardens

- Monitor the Temperature in Your Water Feature
- Easily Read – Calibrated in Both °F and °C
- Included Tether Helps Retrieve Unit
- Packed 6 Per Master Carton



6" STRAIGHT AIR DIFFUSER - ITEM# 14570

- For Use with Pondmaster AP-20 and AP-40 Air Pumps
- 16 sq. in. of Active Surface Area.
- Recommended Tubing Sizes: 1/2" or 5/8"
- Packed 6 Per Master Carton



7" DIAMETER RING AIR DIFFUSER - ITEM# 14580

- For Use with Pondmaster AP-40, AP-60 and AP-100 Air Pumps
- 18" Total Length
- 48 sq. in. of active surface area
- Recommended Tubing Sizes: 3/4" or 1"
- Packed 6 Per Master Carton



AIR DIFFUSER KIT - ITEM# 14575

- Includes 6" Straight Diffuser and 20 Feet of 5/8" Tubing to fit Pondmaster AP-20 and AP-40 Air Pumps.
- Packed Individually



AQUATIC PLANT BASKET - ITEM# 03760

- 10" x 10" x 5.25" (Deep)
- Ideal for Small to Medium Size Aquatic Plants
- Simply Plant and Lower into Pond
- Allows Water to Reach Roots
- Holds Plant and Soil Securely in Place
- Durable and Long Lasting



PONDMASTER SUPER-FLEX POND LINERS

PONDMASTER

PONDMASTER® SUPER-FLEX is a flexible polyethylene-based pond liner that combines the strength of Polyethylene liners with the highest flexibility available. This fish-safe liner is ideal for koi ponds, aquatic habitats, water gardens, waterfalls, fountains and streams. Super-Flex is insect-resistant, making it perfect for residential and commercial applications. Super-Flex is half the weight of traditional EPDM liners. All sizes are pre-cut for the consumer and boxed for easy merchandising.

FEATURES

- Flexible, Long-lasting Liner
- Rugged and Lightweight Aqua-Flex Technology
- Tear/Puncture Resistant
- Heat Sealable and has more Flexibility than Traditional Heavy Rubber Liners
- Insect-Resistant
- Safe for Fish and Plants
- 20 Year Limited Warranty
- All Sizes are Packed 1 per Master



2X
THE PUNCTURE RESISTANCE OF EPDM AND ONLY 1/2 THE WEIGHT

8' X 12' GARDEN POND LINER - ITEM# 02112

6.5' X 5' BARREL & FOUNTAIN LINER - ITEM# 02113

8' X 8' GARDEN POND LINER - ITEM# 02114

12.5' X 15' GARDEN POND LINER - ITEM# 02116

4' X 12' STREAM LINER - ITEM# 02117

Note: Bulk/Roll sizes are available, ask your Danner representative for details.



SUPER-FLEX POND LINER COMPARED TO EPDM

PROPERTY	SUPER FLEX			EPDM		
	TEST METHOD	VALUE	UNIT	TEST METHOD	VALUE	UNIT
Thickness	ASTM D5199	.030	in.	ASTM D-412	0.045	in.
Density/Specific Gravity	ASTM D792 OR D1505	.914	g/cm ³	ASTM D-792	1.2	g/cm ³
Unit Weight	ASTM D0751	146	lbs./MSF	ASTM D-751	290	lbs./MSF
Tensile Strength Break	ASTM D6693	135 (4500)	lbs./in. width (psi)	ASTM D-412 Die C	58 (1305)	lbs./in. width (psi)
Elongation @ Break	ASTM D6693	1000	%	ASTM D-624 Die C	300	%
Tear Resistance	ASTM D1004	10	lbf	ASTM D-624 Die C	6.75	lbf
Puncture Resistance	ASTM 4833	48	lbs.	ASTM D-4833	25	lbs.

PONDMASTER POND NETTING AND POND NETS

POND NETTING

CATCHES FALLING LEAVES AND PROTECTS FISH FROM PREDATORS.

ITEM# 02307 7' x 10' • Packed 18 Per Master Carton

ITEM# 02314 14' x 14' • Packed 12 Per Master Carton

ITEM# 02328 28' x 28' • Packed 6 Per Master Carton



PONDMASTER NETS

Pondmaster Pond Nets fit all your water gardening needs, large and small!

They're available in convenient, small stationary sizes or in larger telescoping sizes that reach up to 6 1/2'.

Pondmaster Pond Nets are very versatile and can be used for general purposes, surface skimming and Koi handling.

FEATURES

- Heavy Duty Aluminum Construction
- Fish-Safe Soft Nylon Netting
- Sure-Grip Handle
- Telescoping Handles Extend up to 6 1/2'
- Convenient String Loop at End of Handle
- Heavily Padded Rims protect Fish and Nets from Damage
- Packed 6 Per Master Carton



COMPACT SKIMMER NET - ITEM# 02144

COMPACT ALL PURPOSE NET - ITEM# 02145

COMPACT KOI NET - ITEM# 02146

TELESCOPING LARGE SKIMMER NET - ITEM# 02134

TELESCOPING LARGE ALL PURPOSE NET - ITEM# 02135

TELESCOPING LARGE KOI NET - ITEM# 02136

COMPACT NET DISPLAY - ITEM# 25023

Includes 6 each of Compact Skimmer Net, Compact All Purpose Net and Compact Koi Net

TELESCOPING NET DISPLAY - ITEM# 25021

Includes 6 each of Telescoping Skimmer Net, Telescoping All Purpose Net and Telescoping Koi Net

TUBING, PUMP BAGS AND BARB FITTINGS

FLEXIBLE BLACK VINYL TUBING

Thick walled tubing is kink resistant.

ITEM# 12012 1/2" I.D. x 10' Roll, Packed 6 Per Master

ITEM# 12014 1/2" I.D. x 20' Roll, Individually Packed

ITEM# 12138 3/8" I.D. x 20' Roll, Packed 6 Per Master

ITEM# 12035 3/4" I.D. x 50' Roll, Individually Packed

ITEM# 12039 3/8" I.D. x 100' Roll, Individually Packed

ITEM# 12013 1/2" I.D. x 100' Roll, Individually Packed

ITEM# 12158 5/8" I.D. x 20' Roll, Packed 6 Per Master

ITEM# 12034 3/4" I.D. x 100' Roll, Individually Packed

ITEM# 12050 1" I.D. x 50' Roll, Individually Packed

CORRUGATED BLACK TUBING

Tubing is reinforced on the outside to resist kinks; Smooth on the inside to increase flow. All designed to accommodate Barbed Fittings.

ITEM# 12404 3/4" I.D. x 20' Roll, Individually Packed

ITEM# 12409 1" I.D. x 20' Roll, Individually Packed

ITEM# 12414 1 1/2" I.D. x 20' Roll, Individually Packed

ITEM# 12435 1 1/2" I.D. x 25' Roll, Individually Packed

ITEM# 12412 1 1/2" I.D. x 50' Roll, Individually Packed

ITEM# 12420 2" I.D. x 50' Roll, Individually Packed

ITEM# 12402 1/2" I.D. x 100' Roll, Individually Packed

ITEM# 12403 3/4" I.D. x 100' Roll, Individually Packed

ITEM# 12410 1" I.D. x 100' Roll, Individually Packed

ITEM# 12411 1 1/4" I.D. x 100' Roll, Individually Packed

REINFORCED FLEXIBLE PVC TUBING

Requires less Fitting compared to rigid pipe. Flexible for easy handling and installation. Can be used with PVC Solvent Cements.

ITEM# 12440 2" Fitting Size x 25' Roll, Individually Packed

ITEM# 12436 1 1/2" Fitting Size x 50' Roll, Individually Packed

ITEM# 12441 2" Fitting Size x 50' Roll, Individually Packed

ITEM# 12443 3" Fitting Size x 50' Roll, Individually Packed

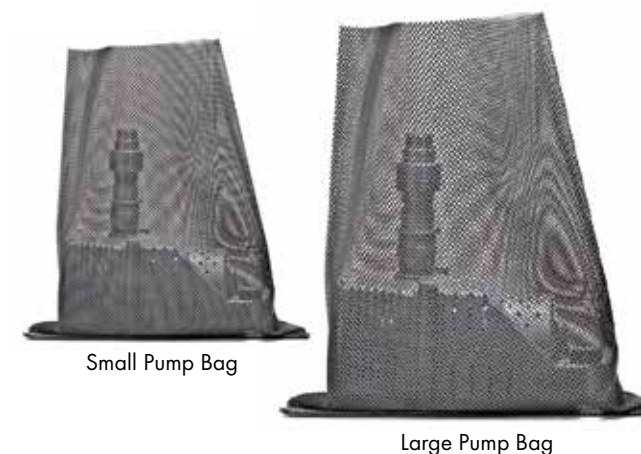

PUMP BAGS

SMALL PUMP BAG (18" X 24") - ITEM# 12315

- Packed 6 Per Master

SMALL PUMP BAG BULK (18" X 24") - ITEM# 33010

- Packed 20 Per Master

LARGE PUMP BAG (24" X 36") - ITEM# 12320

- Packed 6 Per Master

LARGE PUMP BAG BULK (24" X 36") - ITEM# 33020

- Packed 20 Per Master

UNIVERSAL BARBS

1 1/2" MPT X 1 1/2" UNIVERSAL BARB - ITEM# 12937

Unique Double Stepped Barb Accommodates All 1 1/2" Tubing

2" MPT X 2" UNIVERSAL BARB - ITEM# 12939

Unique Double Stepped Barb Accommodates All 2" Tubing



PONDMASTER REPLACEMENT FILTER MEDIA

PONDMASTER has an extensive line of replacement media carefully designed to maintain the effectiveness of the original filter. Coarse polyester and foam filters offer biological filtration; carbon impregnated media offers chemical and biological filtration; all offer mechanical filtration.

REPLACEMENT PADS - ITEM# 12195

For PMK 190

- Foam/Coarse Poly Combo Pak, Packed 6 Per Master

REPLACEMENT PADS - ITEM# 12201

For PM 1000, PM 2000 †*

- Poly 3 Pak, Packed 6 Per Master

REPLACEMENT PADS - ITEM# 12202

For PM 1000, PM 2000*

- Carbon and Coarse Filter Media, Foam Large Double Pack, Packed 6 Per Master

REPLACEMENT PADS - ITEM# 12203

For PM 1000, PM 2000*

- Carbon Single Pak, Packed 6 Per Master

REPLACEMENT PADS - ITEM# 12204

For PM 1000, PM 2000*

- Coarse Poly Single Pak, Packed 6 Per Master

REPLACEMENT PADS - ITEM# 12205

For PM 1000, PM 2000*

- Foam 2 Pak, Packed 6 Per Master

EXTRA LARGE PRE-FILTER - ITEM# 12285

For All Mid-Range Pumps, 250 GPH thru 700 GPH**

- Foam Large Single Pak, Packed 6 Per Master

FOAM BLOCKS - ITEM# 12305

For PM 2000

- Foam 4 Pak, Packed 6 Per Master

REPLACEMENT PRE-FILTER - ITEM# 12505

For All Mid-Range Pumps, 250 GPH thru 700 GPH

- Sleeve Small Single Pak, Packed 6 Per Master

FOAM BLOCK - ITEM# 12600

For Promotional Kits 02272, 02273, 02160

- Pre-Filter Single Pak, Packed 6 Per Master

RIGID PRE-FILTER - ITEM# 12960

For ProLine Skimmer Pumps 1400, 2550, 5100, 6100 and Pumps with 1½" MPT Inlet

RIGID PRE-FILTER - ITEM# 12965

Designed as a Pre-Filter for Pumps with 2" MPT Inlet

PRE-FILTER - ITEM# 12605

Pre-Filter for MD 1, MD 1.5, MD 1.9

- Pre-Filter 3 Pak, Packed 6 Per Master

FOAM PRE-FILTER - ITEM# 12730

For 950 GPH, 1200 GPH, and 1800 GPH Pumps

- Foam Single Pak, Packed 6 Per Master

RIGID PRE-FILTER - ITEM# 12784

Fits 250-700 GPH Pumps

- Packed 6 Per Master

RIGID PRE-FILTER - ITEM# 12785

Fits 950-3600 GPH Pumps

BIO-MATRIX MEDIA - ITEM# 12200 (NOT SHOWN)

For All ProLine Pressurized Filters (Not For Use in Clearguard Filters)

- 8 lbs. Bulk Media

BIO-MATRIX MEDIA - ITEM# 12455

Fits Small & Medium Filter Falls

- 2 lb. Mesh Bag, Packed 4 Per Master



† Low cost one time use

* This filter media is also a replacement for Pondmaster Kits 02212, 02213, 02215, and 02217

** This filter media is also a replacement for Aquabelle Kits 02282 and 02285

PONDMASTER REPLACEMENT MEDIA, IMPELLER ASSEMBLIES & LED BOARD

PONDMASTER

PM 500 REPLACEMENT MEDIA

REPLACEMENT CARBON AND COARSE MEDIA - ITEM# 12207

- Complete Replacement of Original Media

REPLACEMENT COARSE POLYESTER MEDIA - ITEM# 12208

- 2 Pack, Coarse Media Traps Larger Debris

REPLACEMENT FOAM FILTER - ITEM# 12209

- 2 Pack, More Reusable Media

REPLACEMENT FINE POLYESTER MEDIA - ITEM# 12210

- 2 Pack, Finer Filtering of Debris

COMPLETE REPLACEMENT CARTRIDGE - ITEM# 12211

- Complete Cartridge with Original Media Included

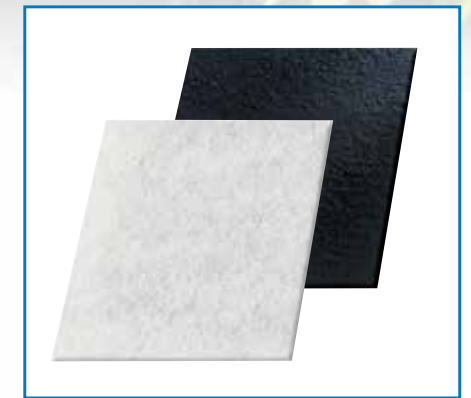

REPLACEMENT IMPELLER ASSEMBLIES

Packed 6 Per Master Carton and individually blister packed or boxed

ITEM# 12650

- For Mini Pump, ITEM# 02510

ITEM# 11655

- For MD 1 Pump, ITEM# 02520

ITEM# 12655

- For MD 1.5 Pump, ITEM# 02521

ITEM# 12955

- For MD 1.9 Pump, ITEM# 02519

ITEM# 12555

- For Model 2 Pumps, ITEM# 02512 and ITEM# 02522

ITEM# 12575

- For Model 3 and 5 Pumps, ITEM# 02513, ITEM# 02523, ITEM# 02515, ITEM# 02525

ITEM# 12585

- For Model 7 Pumps, ITEM# 02517 and ITEM# 02527

ITEM# 12746

- For Model 9.5B Pumps, ITEM# 02710 and ITEM# 02720

ITEM# 12756

- For Model 12B Pumps, ITEM# 02712 and ITEM# 02722

ITEM# 12776

- For Model 18B Pumps, ITEM# 02718 and ITEM# 02728

ITEM# 12780

- For Model 24 Pumps Type 'A', ITEM# 02740 and ITEM# 02750

ITEM# 12791

- For Model 24 Pumps Type 'B', ITEM# 02740 and ITEM# 02750

ITEM# 12790

- For Model 36 Pumps Type 'A', ITEM# 02745 and ITEM# 02755

ITEM# 12796

- For Model 36 Pumps Type 'B', ITEM# 02745 and ITEM# 02755

ITEM# 16505

Venturi Assembly with Tubing and Muffler

- For Pump Models 2, 3, 5, 7

ITEM# 16555

Fractionating Impeller Assembly

- For Pump Model 2

ITEM# 16575

Fractionating Impeller Assembly

- For Pump Models 3 and 5

ITEM# 16585

Fractionating Impeller Assembly

- For Pump Model 7

ITEM# 16705

Venturi Assembly with Tubing and Muffler

- For Pump Models 9.5, 12 and 18

ITEM# 16745

Fractionating Impeller Assembly

- For Pump Model 9.5

ITEM# 16755

Fractionating Impeller Assembly

- For Pump Model 12

ITEM# 16775

Fractionating Impeller Assembly

- For Pump Model 18

ITEM# 12792

- For Hydro-Air™, ITEM# 02795

FOR A COMPLETE LIST OF REPLACEMENT IMPELLER ASSEMBLIES, VISIT WWW.DANNERMFG.COM

REPLACEMENT 2.0 W LED BOARD - ITEM# 12330

For use with Pondmaster 1 and 3 LED Pond Lights, Item# 02387 and Item# 02389

- Easy to Install
- Packed 4 Per Master Carton



PONDMASTER D-I-Y POND MENU HEADER AND "LET'S GET STARTED" PLAN-O-GRAMS

PONDMASTER "LET'S GET STARTED" PLAN-O-GRAMS

PONDMASTER

PONDMASTER D-I-Y POND MENU HEADER - ITEM# 32510

CUSTOMIZE YOUR OWN KITS WITH PONDMASTER D-I-Y SIGNS! Retailers now have the flexibility to make/sell their own D-I-Y Kits to consumers, instead of being limited to contents defined by manufacturers. Simply write in your favorite Pondmaster Products that you recommend in a pond or vanishing waterfall set-up... and sell them "a-la-carte" to your customers.

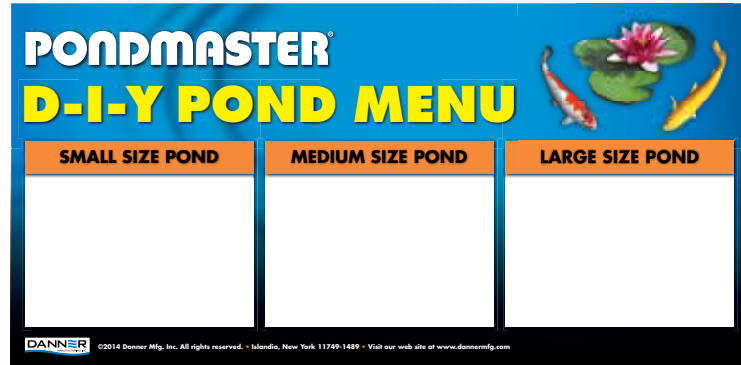

PONDMASTER "LET'S GET STARTED" PLAN-O-GRAMS

2 FOOT PLAN-O-GRAM ITEM# 27505

3 FOOT PLAN-O-GRAM ITEM# 27510

4 FOOT PLAN-O-GRAM ITEM# 27520



2 FOOT PLAN-O-GRAM ITEM# 27505

TOP SHELF FOUNTAIN/STATUARY WATER PUMPS	ITEM#
THE FOUNTAIN PUMP, 70 GPH	01703
THE FOUNTAIN PUMP, 120 GPH	01713
THE FOUNTAIN PUMP, 290 GPH	01723

2ND SHELF POND WATER PUMPS	ITEM#
PM POND-MAG 250 GPH	02522
PM POND-MAG 500 GPH	02525

3RD SHELF POND WATER PUMPS & FILTERS	ITEM#
PM POND-MAG 950 GPH	02720
PMK 190 POND FILTER SYSTEM	02019

4TH SHELF POND WATER PUMPS & LIGHTS	ITEM#
PM POND-MAG, 1800 GPH	02728
PM LED POND LIGHT W/ TRANSFORMER	02387

5TH SHELF POND LINER & WATERFALLS	ITEM#
PM SUPER-FLEX POND LINER 6.5" X 5"	02113
PROLINE PRO1000 WATERFALL BOX	02477

3 FOOT PLAN-O-GRAM ITEM# 27510

TOP SHELF FOUNTAIN/STATUARY WATER PUMPS	ITEM#
THE FOUNTAIN PUMP, 70 GPH	01703
THE FOUNTAIN PUMP, 120 GPH	01713
THE FOUNTAIN PUMP, 200 GPH	01717
THE FOUNTAIN PUMP, 290 GPH	01723
THE FOUNTAIN PUMP, 400 GPH	01727

2ND SHELF POND WATER PUMPS	ITEM#
PM POND-MAG 250 GPH	02522
PM POND-MAG 500 GPH	02525
PM POND-MAG 700 GPH	02527

3RD SHELF POND WATER PUMPS & FILTERS	ITEM#
PM POND-MAG 950 GPH	02720
PM POND-MAG 1800 GPH	02728
PMK 190 POND FILTER SYSTEM	02019

4TH SHELF POND LIGHTS, WATERFALLS & FILTERS	ITEM#
PM LED POND LIGHT W/ TRANSFORMER	02387
PROLINE PRO1000 WATERFALL BOX	02477
PM 1000 GARDEN POND FILTER	02211

5TH SHELF POND LINERS	ITEM#
PM SUPER-FLEX POND LINER 6.5" X 5"	02113
PM SUPER-FLEX POND LINER 8.3" X 8"	02114

4 FOOT PLAN-O-GRAM ITEM# 27520

TOP SHELF FOUNTAIN/STATUARY WATER PUMPS	ITEM#
THE FOUNTAIN PUMP, 70 GPH	01703
THE FOUNTAIN PUMP, 93 GPH	01707
THE FOUNTAIN PUMP, 120 GPH	01713
THE FOUNTAIN PUMP, 200 GPH	01717
THE FOUNTAIN PUMP, 290 GPH	01723
THE FOUNTAIN PUMP, 400 GPH	01727

2ND SHELF POND WATER PUMPS	ITEM#
PM POND-MAG 250 GPH	02522
PM POND-MAG 300 GPH	02523
PM POND-MAG 500 GPH	02525
PM POND-MAG 700 GPH	02527

3RD SHELF POND WATER PUMPS & LIGHTS	ITEM#
PM POND-MAG 950 GPH	02720
PM POND-MAG 1800 GPH	02728
PM 3 LED POND LIGHTS WITH TRANSFORMER	02389
PM LED POND LIGHT W/ TRANSFORMER	02387

4TH SHELF POND WATER PUMPS & FILTERS	ITEM#
PMK 190 POND FILTER SYSTEM	02019
PM 1000 GARDEN POND FILTER	02211
PM 1500 PUMP & FILTER KIT	02215

5TH SHELF POND LINERS & WATERFALLS	ITEM#
PM SUPER-FLEX POND LINER 6.5" X 5"	02113
PM SUPER-FLEX POND LINER 8.3" X 8"	02114
PROLINE PRO1000 WATERFALL BOX	02477

NOTE for All Plan-o-Grams: Must order one full case (Danner Master Carton Quantity) of each item, except for liners. A minimum of four units of liner must be ordered.

PONDMASTER® ECO



PONDMASTER ECO WATER PUMPS

THE BEST OF THE BEST. We've carefully reviewed our entire utility pump line to create the Pondmaster Eco collection of rugged, economical and proven pumps. Each pump has a built-in variable Flow Control and is specifically designed for small-to-medium size ponds, statuary and aquarium applications. Built to run steady and quiet, they will never intrude on the tranquility of any water feature or home aquarium.

FEATURES

- Energy-Efficient Magnetic Drive
- Variable Flow Control
- Debris-Reducing Pre-Filter
- All Fittings Included
- 6" Power Cord
- 2 Year Limited Warranty

PONDMASTER ECO 55 GPH PUMP ITEM# 80410

Max. Flow Rate	55 GPH
Max. Pumping Height	2'
Watts	5.75
Power	115V, 60Hz
Intake	Screened*
Discharge	1/4" and 3/8" Stepped Slip Fitting
Cord Length	6'

*For Submersible Use Only.

PONDMASTER ECO 75 GPH PUMP ITEM# 80415

Max. Flow Rate	75 GPH
Max. Pumping Height	2.5'
Watts	5.75
Power	115V, 60Hz
Intake	Screened*
Discharge	1/2" and 3/8" Male Slip Fitting
Cord Length	6'

*For Submersible Use Only.



DESIGNED SPECIFICALLY FOR TABLE TOP FOUNTAINS AND SMALL STATUARY

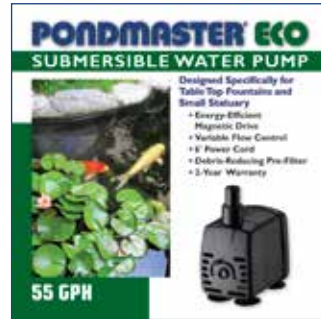

PONDMASTER ECO WATER PUMPS

FEATURES

- Energy-Efficient Magnetic Drive
- Variable Flow Control
- Debris-Reducing Pre-Filter
- All Fittings Included
- 15' Power Cord
- 2 Year Limited Warranty

PONDMASTER ECO 175 GPH PUMP ITEM# 80430

Max. Flow Rate	175 GPH
Max. Pumping Height	4'
Watts	10.5
Power	115V, 60Hz
Intake	Screened*
Discharge	1/2" and 3/8" Threaded Barbed Fitting
Cord Length	15' with Ground Plug

*Includes 3/4" Threaded Intake for In-Line use w/ screen removed.



PONDMASTER ECO 590 GPH PUMP ITEM# 80445

Max. Flow Rate	590 GPH
Max. Pumping Height	7.5'
Watts	40
Power	115V, 60Hz
Intake	Screened*
Discharge	1/2" and 3/4" Threaded Barbed Fittings
Cord Length	15' with Ground Plug

*Includes 3/4" Threaded Barbed Fitting for In-line use.



PONDMASTER ECO 1000 GPH PUMP ITEM# 80450

Max. Flow Rate	1000 GPH
Max. Pumping Height	9'
Watts	70
Power	115V, 60Hz
Intake	Screened*
Discharge	3/4" and 1" Threaded Barbed Fittings
Cord Length	15' with Ground Plug

*Includes 1" Threaded Intake for In-Line use w/ screen removed.



PONDMASTER ECO 1350 GPH PUMP ITEM# 80455

Max. Flow Rate	1350 GPH
Max. Pumping Height	13.5'
Watts	125
Power	115V, 60Hz
Intake	Screened*
Discharge	3/4" and 1" Threaded Barbed Fittings
Cord Length	15' with Ground Plug

*Includes 1" Threaded Barbed Fitting for In-line use.



PONDMASTER ECO

DESIGNED SPECIFICALLY FOR PONDS AND STATUARY

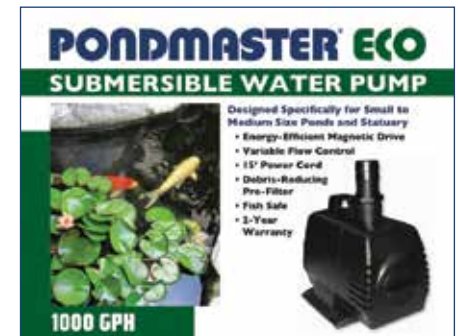
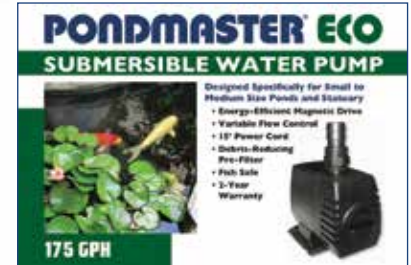



PONDMASTER ECO FOUNTAINHEAD & PUMP KITS

PONDMASTER ECO

FOUNTAINHEAD PUMP KITS ADD A NEW DIMENSION TO ANY WATER FEATURE. We've paired our most popular size pumps with variable flow control fountainheads to give homeowners an opportunity to create an entirely different mood in their pond. These reliable Pondmaster Eco Pump and Fountainhead Kits will work well with any small-to-medium size installations.

FEATURES

- Energy-Efficient Magnetic Drive Pump
- Fountainhead Variable Flow Control
- Intake Pre-Filter
- 15' Power Cord with Grounded Plug
- 2 Year Limited Warranty



Bell Shape



Fleur de Lis



Double
Fleur de Lis

PONDMASTER ECO 225 GPH KIT ITEM# 82415

Maximum Flow	225 GPH
Maximum Pumping Height	6.0'
Watts	19
Power	115V, 60Hz
Barbed Adaptors Included	1/2" and 3/4"
Fountainheads Included:	Bell Shape & Fleur de Lis



PONDMASTER ECO 400 GPH KIT ITEM# 82425

Maximum Flow	400 GPH
Maximum Pumping Height	6.5'
Watts	20
Power	115V, 60Hz
Barbed Adaptors Included	1/2" and 3/4"
Fountainheads Included:	Bell Shape & Fleur de Lis



PONDMASTER ECO 590 GPH KIT ITEM# 82435

Maximum Flow	590 GPH
Maximum Pumping Height	7.5'
Watts	40
Power	115V, 60Hz
Barbed Adaptors Included	1/2" and 3/4"
Fountainheads Included:	Bell Shape, Fleur de Lis & Double Fleur de Lis



ProLine™

PROLINE PRESSURIZED FILTER SYSTEMS

THE PROLINE PRESSURIZED FILTER SYSTEM features a unique, manually operated agitator that quickly dislodges waste from the filter chamber which allows you to backwash and rinse the filter in seconds without getting wet or coming in contact with fish and plant waste. Best of all, these filters never need to be opened. Available with or without an internally mounted UV Clarifier that controls green water algae.

FEATURES:

- Agitator Quickly Dislodges Waste, Conserving Water During Backwash and Rinse Cycles
- 3-Way Master Valve with "Filter," "Rinse" and "Backwash" Settings
- Clear-view Inspection Port to Monitor Water Clarity During Backwash/Rinse Operation
- Stainless Steel Clamp to Ensure a Water Tight Seal
- Bio-Matrix™ Media Provides Maximum Surface Area for Beneficial Bacteria Growth
- Heavy Duty Poly Canister Can Be Buried for Hidden Installation
- Integrated Waterproof UV Transformer (for Models Equipped with UV Clarifier)
- Optional Field Installed Bottom Drain Available (Not Included)
- 1½" Swivel Fittings and Ball Valve Included
- Packed 1 Per Master Carton



WITHOUT UV CLARIFIER

P-1000 - ITEM# 05010

1000 Gallon Capacity, without UV Clarifier
Recommended Pump Size: 900 - 2000 GPH
with 20' Max Total Head Height

P-2000 - ITEM# 05020

2000 Gallon Capacity, without UV Clarifier
Recommended Pump Size: 1000 - 2000 GPH
with 20' Max Total Head Height

P-4000 - ITEM# 05040

4000 Gallon Capacity, without UV Clarifier
Recommended Pump Size: 1000 - 4000 GPH
with 20' Max Total Head Height

WITH UV CLARIFIER

PUV-1000 - ITEM# 05015

1000 Gallon Capacity, with 10 Watt UV Clarifier
Recommended Pump Size: 900 - 2000 GPH
with 20' Max Total Head Height

PUV-2000 - ITEM# 05025

2000 Gallon Capacity, with 20 Watt UV Clarifier
Recommended Pump Size: 1000 - 2000 GPH
with 20' Max Total Head Height

PUV-4000 - ITEM# 05045

4000 Gallon Capacity, with 40 Watt UV Clarifier
Recommended Pump Size: 1000 - 4000 GPH
with 20' Max Total Head Height



05040
05045



05010
05015



3-WAY MASTER VALVE SHOWN WITH SWIVEL FITTINGS.

Included Swivel Fittings make connecting and removing flexible tubing easier and quicker.

PROLINE PRESSURIZED FILTER SYSTEM

ProLine™



PRESSURE GAUGE

WASTE PORT VALVE

ETL LISTED
UV LAMP BALLAST

3-WAY MASTER VALVE

CLEAR AGITATOR
HANDLE ALLOWS FOR
UV VIEWING

HEAVY DUTY
POLY CANISTER

AGITATOR

UV LAMP

BIO-MATRIX MEDIA

OPTIONAL BOTTOM DRAIN



UV CLARIFIER CONVERSION KIT FOR PRESSURE FILTERS

Add the Benefit of an Ultraviolet Clarifier to your existing Pondmaster/ProLine Low Pressure Filter. Helps clear pond of green water algae. It's easy to install and includes a 10, 20, or 40 Watt UV lamp with 9000 hour lamp life, high quality quartz sleeves, and submersible transformer with 18' power cord.

10 WATT CONVERSION KIT - ITEM# 15210

For Use with Pondmaster and ProLine Low Pressure Filters: Model PF-2000 (ITEM# 05310) and Model P-1000 (ITEM# 05010)

20 WATT CONVERSION KIT - ITEM# 15220

For Use with Pondmaster and ProLine Low Pressure Filters: Model PF-2000 (ITEM# 05310) and Model P-2000 (ITEM# 05020)

40 WATT CONVERSION KIT - ITEM# 15240

For Use with Pondmaster and ProLine Low Pressure Filters: Model PF-3000 (ITEM# 05340) and Model P-4000 (ITEM# 05040)

HIGH-FLOW SUBMERSIBLE WATER PUMPS



HFS PUMP 1/6 HP - ITEM# 90101

Voltage	120V 60Hz /2.7 Amps
Max. Head Heigh	23' (7 M)
Max. Flow	1860 GPH (117 LPM)
Speed	3450 R.P.M.
Solid Handling Capability	3/4"
Weight	9 lbs.
Dimensions (L x W x H)	7 5/8" x 5 1/4" x 12 1/2"

HFS PUMP 1/5 HP - ITEM# 90102

Voltage	120V 60Hz /3.5 Amps
Max. Head Heigh	28' (8.5 M)
Max. Flow	3000 GPH (193 LPM)
Speed	3450 R.P.M.
Solid Handling Capability	3/4"
Weight	10.5 lbs.
Dimensions (L x W x H)	7 5/8" x 5 1/4" x 13 1/4"

HFS PUMP 1/4 HP - ITEM# 90103

Voltage	120V 60Hz /3.5 Amps
Max. Head Heigh	21' (6.4 M)
Max. Flow	3270 GPH (206 LPM)
Speed	3450 R.P.M.
Solid Handling Capability	1 1/8"
Weight	13.5 lbs.
Dimensions (L x W x H)	9 1/2" x 6 1/2" x 14"

HFS PUMP 1/3 HP - ITEM# 90104

Voltage	120V 60Hz /5.0 Amps
Max. Head Heigh	27' (8.2 M)
Max. Flow	4800 GPH (302 LPM)
Speed	3450 R.P.M.
Solid Handling Capability	1 3/8"
Weight	14.5 lbs.
Dimensions (L x W x H)	9 1/2" x 6 1/2" x 14 1/8"

HFS PUMP 1/2 HP - ITEM# 90105

Voltage	120V 60Hz /6.0 Amps
Max. Head Heigh	35' (10.7 M)
Max. Flow	5904 GPH (372 LPM)
Speed	3450 R.P.M.
Solid Handling Capability	1 3/8"
Weight	17 lbs.
Dimensions (L x W x H)	9 1/2" x 6 1/2" x 14 3/4"

HFS PUMP 1.0 HP - ITEM# 90106

Voltage	120V 60Hz /8.5 Amps
Max. Head Heigh	44' (13.4 M)
Max. Flow	7200 GPH (454 LPM)
Speed	3450 R.P.M.
Solid Handling Capability	1 3/8"
Weight	19.5 lbs.
Dimensions (L x W x H)	9 1/2" x 6 1/2" x 15 1/4"



FEATURES

- Completely submersible
- 24 hour continuous duty operation
- High-capacity fluid transfer
- 2 Year Limited Warranty

VORTEX IMPELLER FOR INCREASED TORQUE FLOW

The torque flow impeller eliminates clogging and binding. Made of F.R.P. (fiberglass reinforced plastic) for minimal abrasive wear.

RUGGED MOTOR

Durable, Stainless steel. Corrosion resistant motor.

BUILT-IN THERMAL PROTECTION

Self-Resetting automatic protection against overload or overheat conditions.

HIGH QUALITY MECHANICAL SEALS

Double Silicone Carbide mechanical seals (Impeller side) for increased performance and additional abrasive resistance.

LARGE SOLID HANDLING CAPABILITY

Non-clog vortex impeller and volute designed for water containing decomposed plant matter and debris.

INCLUDES

1 1/2" and 2" Barbed Fitting: 1/6 HP, 1/5 HP & 1/4 HP
2" Barbed Fitting: 1/3 HP, 1/2 HP & 1 HP

GREAT FOR

Ponds, Fountains, Fish-Farming, Landscapes, Irrigation, Water Gardening, Aquaculture (Water Circulation), Agricultural, Streams, Cascades, Waterfalls, Water Transfer, Recirculation and Water Drainage.

PROLINE HY-DRIVE WATER PUMPS WITH PROTECTIVE CAGE



PROLINE HY-DRIVE PUMPS are unique, high-capacity pumps designed specifically for use in larger pond installations. The Hy-Drive design combines the benefits of magnetic and direct drive technologies to deliver great performance and high efficiency in an extremely quiet, low maintenance package. The heavy-duty polypropylene enclosure has a built-in carry handle and effective molded-in debris screen. Hy-Drive pumps can be positioned vertically or horizontally and can be used as a submersible pump or as an in-line, external pumping source. Available in 1600, 2100, 2600, 3200, 4000, 4800, and 6000 GPH capacities.

FEATURES

- Powerful, Efficient Hybrid Magnetic Induction Motor
- High-Efficiency Vortex Impeller
- Whisper Quiet Continuous Duty Operation
- Oil-Free / Fish Safe
- Convenient Carry Handle
- Submersible or In-line Operation
- Threaded Female Couplings and Fittings Included
- Extra-Long Clog Resistant Filter Screen
- Can be positioned vertically or horizontally
- 20' Grounded Power Cord
- Packed 2 per Master Carton
- 3 Year Limited Warranty



ProLine Hy-Drive inside of Pump Bag (sold separately)



6000 ProLine Hy-Drive without Pump Housing



316 STAINLESS STEEL ROTOR FOR GREATER CORROSION & WEAR RESISTANCE

1600 HY-DRIVE - ITEM# 02663

Max. Watts/Amps	120/1.0
Inlet	1"
Outlet	1"
Cord Length	20'
Dimensions (L x W x H)	13" x 6 3/8" x 6"

2100 HY-DRIVE - ITEM# 02665

Max. Watts/Amps	190/1.5
Inlet	1"
Outlet	1"
Cord Length	20'
Dimensions (L x W x H)	13" x 6 3/8" x 6"

2600 HY-DRIVE - ITEM# 02667

Max. Watts/Amps	270/2.2
Inlet	1"
Outlet	1"
Cord Length	20'
Dimensions (L x W x H)	15" x 7.25" x 7.75"

3200 HY-DRIVE - ITEM# 02680

Max. Watts/Amps	160/1.5
Inlet	1 1/2"
Outlet	1 1/2"
Cord Length	20'
Dimensions (L x W x H)	15" x 7.25" x 7.75"



4000 HY-DRIVE - ITEM# 02675

Max. Watts/Amps	200/1.85
Inlet	1 1/2"
Outlet	1 1/2"
Cord Length	20'
Dimensions (L x W x H)	15" x 7.25" x 7.75"

4800 HY-DRIVE - ITEM# 02670

Max. Watts/Amps	280/2.15
Inlet	1 1/2"
Outlet	1 1/2"
Cord Length	20'
Dimensions (L x W x H)	15" x 7.25" x 7.75"

6000 HY-DRIVE - ITEM# 02683

Max. Watts/Amps	675/5.5
Inlet	2"
Outlet	2"
Cord Length	20'
Dimensions (L x W x H)	15 1/2" x 7" x 8"

PM NAME	PM ITEM#	Watts	Flow at 1'	Flow at 3'	Flow at 5'	Flow at 7'	Flow at 10'	Flow at 15'	Flow at 20'	Flow at 25'	Shut-Off (Feet)
PLHD 1600	02663	120	1700	1575	1400	1250	1000	375	-	-	17'
PLHD 2100	02665	190	2075	1900	1750	1600	1300	850	300	-	22' 5"
PLHD 2600	02667	270	2550	2525	2450	2225	1975	1625	1250	300	26' 5"
PLHD 3200	02680	160	3300	2700	2050	1650	650	-	-	-	12'
PLHD 4000	02675	200	4000	3300	2700	2350	1475	-	-	-	13'
PLHD 4800	02670	280	5000	4500	3900	3150	2350	800	-	-	18' 5"
PLHD 6000	02683	675	5500	5100	4700	4200	3650	2450	1150	-	22' 5"

PROLINE SKIMMER PUMPS WITH HY-DRIVE TECHNOLOGY

PROLINE HY-DRIVE SKIMMER PUMPS are designed to fit most pond skimmer filters while delivering reliable and powerful performance. Employs hybrid technology that integrates the power of direct drive pumps and the energy efficiency and safety of magnetic drive pumps. Continuous duty pumps move large volumes of water silently and efficiently through filtration systems or to a waterfall, stream or fountain. High efficiency vortex impeller, ceramic impeller shaft and bearings provide energy savings while maintaining high output.

FEATURES

- Designed to Move Large Volumes of Water, Silently and Efficiently
- High Efficiency Vortex Impeller
- Unique Upright Design, Specifically for Pond Skimmer Use
- Rigid Pre-Filter Stabilizes Pump while Protecting it from Large Debris
- 1½" Male Outlet and 1½" Elbow Included
- Pump Bag Included for Extra Pump Protection
- Packed 2 per Master Carton
- 3 Year Limited Warranty

1400 GPH SKIMMER PUMP - ITEM# 20350

Max. Flow Rate	1400 GPH
Max. Pumping Height	19'
Max. Watts/Amps	150/1.3 A
Cord Length	20'

2550 GPH SKIMMER PUMP - ITEM# 20355

Max. Flow Rate	2550 GPH
Max. Pumping Height	11' 5"
Max. Watts/Amps	147/1.3 A
Cord Length	20'

5100 GPH SKIMMER PUMP - ITEM# 20360

Max. Flow Rate	5100 GPH
Max. Pumping Height	30'
Max. Watts/Amps	439/3.6 A
Cord Length	20'

6600 GPH SKIMMER PUMP - ITEM# 20365

Max. Flow Rate	6600 GPH
Max. Pumping Height	30' 6"
Max. Watts/Amps	593/4.9 A
Cord Length	20'



PROLINE PRO1000 & 2000 FILTER AND FALLS



FEATURES

- Wide Spillway for Greater Water Aeration
- Easily Buried In Ground To Hide Box from Sight
- Made of High Impact Polypropylene
- Includes Stepped Barb Fittings to Accommodate ¾", 1", 1¼" and 1½" Tubing
- Designed to Accommodate Addition of Mechanical or Biological Filter Media for Super Clean Water
- Packed 4 Per Master Carton



PRO1000 WATERFALL BOX - ITEM# 02477 (Media or Filter Not Included)

PRO1000 WITH BIOMATRIX MEDIA - ITEM# 02478

PRO1000 WITH DEBRIS FILTER - ITEM# 02479

Unit Dimensions	8¾" L x 12" W x 6½" H
Waterfall Width	8" Opening
Container Capacity	1 Gallon
Maximum Pump Flow	950 GPH

PRO2000 WATERFALL BOX - ITEM# 02467 (Media or Filter Not Included)

PRO2000 WITH BIOMATRIX MEDIA - ITEM# 02468

PRO2000 WITH DEBRIS FILTER - ITEM# 02469

Unit Dimensions	12¾" L x 12¼" W x 8" H
Waterfall Width	11¼" Opening
Container Capacity	1.5 Gallon
Maximum Pump Flow	2000 GPH

CALL YOUR DANNER REPRESENTATIVE TO FIND OUT ABOUT OUR BULK PACKED PALLET

PROLINE PRO 3000 FILTER AND FALLS

FEATURES

- Extra-Wide Spillway for Greater Water Aeration
- Baffle Chamber for Even and Efficient Waterfall Flow Through the Filter Media
- Easily Buried In Ground To Hide Box from Sight
- Holds More Friendly Bacteria to Help Filtration
- Made of High Impact Polypropylene
- Extra Long Weir Lip for Stacking Stones in Front of Waterfall
- Pre-Bored Inlet Size of 2½"
- Includes Bulkhead Fitting and 2" Barbed Fitting
- Packed Individually



PRO3000 WATERFALL BOX - ITEM# 02481 (Media or Filter Not Included)

PRO3000 WITH BIOMATRIX MEDIA - ITEM# 02480

PRO3000 WITH DEBRIS FILTER - ITEM# 02482

Unit Dimensions	16" L x 18" W x 13" H
Waterfall Width	16" Opening
Container Capacity	4 Gallon
Maximum Pump Flow	3000 GPH

PM NAME	PM ITEM#	Watts	Flow at 1'	Flow at 3'	Flow at 5'	Flow at 7'	Flow at 10'	Flow at 15'	Flow at 20'	Flow at 25'	Flow at 30'	Shut-Off (Feet)
SKP 1400	20350	150	1350	1250	1150	1100	925	650	-	-	-	19'
SKP 2550	20355	147	2375	2000	1500	1050	450	-	-	-	-	11' 6"
SKP 5100	20360	439	5100	5050	4650	4375	3900	3050	2375	1675	-	30'
SKP 6600	20365	593	6600	6275	5500	4925	4325	3325	2425	1850	550	30' 6"

PROLINE PRO5000 FILTER AND FALLS

FEATURES

- Extra Wide Spillway for Greater Water Aeration
- Can be used Side by Side to Create a Larger Waterfall
- Open Swirl Chamber for Even and Efficient Water Flow through The Filter Media
- 3 Separate Filtering Actions for Super Clean Water
- Easily Buried In Ground To Hide Canister from Sight
- XL Capacity Designed To Increase Biological Filtration
- Upflow Grate Contains Media and Assures Uniform Filtering
- Available with Coarse Debris Pad which Removes Even the Finest Suspended Debris From Pond Water
- Extra Long Weir Lip For Stacking Stones In Front of the Waterfall
- Recommended to Clean Once a Year
- Packed Individually

PRO5000 FILTER AND FALLS WITH BIOMATRIX MEDIA - ITEM# 02490

PRO5000 FILTER AND FALLS WITH DEBRIS PAD - 02492

Unit Dimensions	18" L x 25" W x 17" H
Waterfall Width	18" Opening
Media Surface Area	75 Sq. Ft.
Maximum Pump Flow	5000 GPH
Weight	10 lbs.



PROLINE PRO5000 SKIMMER

FEATURES

- Strong Ribbed Cylindrical Housing Eliminates Cave-Ins
- Made from Heavy Duty High Density Polyethylene
- Ribs Anchor the Skimmer Solidly in Place, No Shifting or Heaving
- Tall 7" x 11" Wide Door for Efficient Skimming Over a Wide Range of Water Levels
- Install 2 Pumps in the Same Skimmer for Massive Flows and Maximum Efficiency
- Large Capacity Clog Resistant Leaf Basket that Keeps Debris Away from the Pump
- Accommodates Most Pumps Up to 8,000 GPH
- Versatile Bulkhead Placement Allows Multiple Inlets and Fittings Up to 2"
- Skimmer Lid Supports 300 lbs.
- For Maximum Cleaning, Use with Clearguard or ProLine Pressurized Filter Systems.
- Packed Individually

FEATURES WITH DEBRIS PAD

- Quickly Removes Fine Particulates Such as Floating Dust and Pollen
- Provides Ideal Medium for Biological Filtration
- Bypass Slotting Ensures Water Flow to Protect Pump Even When Pad Needs Cleaning
- Easily Cleaned and Inexpensive to Replace



Model 02474 with Debris Filter Shown

PRO5000 SKIMMER - ITEM# 02475

PRO5000 SKIMMER WITH DEBRIS PAD - ITEM# 02474

Weir Size Opening	11" W x 7" H
Unit Dimensions	24" L x 26" W x 23" H
Max. Pump Capacity	8,000 GPH
Operating Surface Area	500 Sq. Ft.
Weight	18 lbs.

PROLINE PUMP VAULTS



PROLINE VAULTS ARE STURDY HOUSINGS USED IN SELF-CONTAINED WATERFALLS AND STREAMS.

They will accommodate submersible pumps up to 10,000 GPH and are specially designed to withstand clogs and heavy stones. Create your own dramatic natural looking water highlight that offers all the beauty and pleasing sounds of a waterfall in a fraction of the space. A self-contained waterfall or stream is easy to install and even easier to maintain. Best of all, it's pet and child safe. ProLine Pump Vaults are the basis for creating a long lasting, trouble-free installation.

FEATURES

- Acts As A Pre-Filter to Protect Submerged Pump Intakes from Getting Clogged with Gravel or Debris
- Built of Rugged, Weather-Resistant Polyethylene Plastic
- Horizontal Hooded Intake Slots Resist Clogging and Sedimentation from Top to Bottom
- Reinforced Lid Withstands The Weight of Gravel and Stones
- Works Great For Free Standing Fountains, Endless Streams and Waterfalls
- Buttressed To Withstand Backfilling Without Warping or Collapsing
- Pre-Bored for 1½" and 2" Pipe with Bulkheads for Auto Fill Valve on 2000 and 4800; Auto Fill Valve Included with Pro 4800
- Packed Individually

PRO2000 MINI PUMP VAULT - ITEM# 02465

Maximum Pump Flow	4000 GPH
Unit Dimensions	15" L x 15" W x 17" H
Weight	12 lbs.

PRO4800 PUMP VAULT - ITEM# 02460

Maximum Pump Flow	10,000 GPH
Unit Dimensions	23" L x 23" W x 25" H
Weight	16 lbs.



02465



02460

PROLINE APP-CONTROLLED MULTI-COLOR LED SPILLWAYS



INTRODUCING THE PROLINE APP-CONTROLLED MULTI-COLOR LED SPILLWAYS

for self-contained Waterfalls, Hardscapes, Retaining Walls and anywhere else you desire the beauty and tranquility of soothing flowing water. ProLine App-Controlled Multi-Color LED Spillways are iOS and Android compatible using the Smart Life App, which is available for free within the Apple App Store or Google Play Store. Connect to Smart Life utilizing the Spillway's integrated 2.4 GHz WiFi controller (no secondary hub required) to control the lighting within the LED Spillway, now making your mobile device your remote control. This eliminates the need for a separate remote and the hassle of changing batteries or losing it.

Explore the infinite color possibilities within Smart Life and its adjustable color and temperature settings to suit your needs. It features 8 pre-programmed scenes: 4 scenes designed as Night, Reading, Party and Leisure while the other 4 scenes; Soft, Rainbow, Shine and Gorgeous can be adjusted based on your mood. You can also set up multiple schedules to turn the lighting on/off according to your desired preset time. Schedules can be repeated daily or weekly.

Keeping up with current trends, Smart Life also works with voice control via Amazon Echo, Alexa, Google Home and Assistant. You can also add and control multiple LED Spillways at one time within the Smart Life App.

FEATURES

- App-Controlled LED Spillway compatible w/ iOS and Android devices
- Free 'Smart Life' App available in the Apple App Store or Google Play Store
- Your mobile device is your remote control, Eliminates the need for a separate remote
- Connect w/ the Spillways waterproof 2.4 GHz WiFi controller
- Infinite color possibilities w/ adjustable settings
- Works w/ Voice Control via Amazon Echo, Alexa, Google Home and/or Assistant
- Interior baffling system that produces a single, lighted water sheet
- Reinforced opening with 5" Lip Extension
- 12" Spillway: Bottom Mount with included 3/4" to 1 1/4" Stepped Barbed Fitting
- 24" and 36" Spillway: Bottom Mount with integrated 1 1/2" Female Threaded Connection
- 43' power cord length w/ rain-proof transformer & waterproof WiFi controller
- Recommended pump sizes: 1200 GPH for 12" Spillway, 2400 GPH for 24" Spillway and 3600 GPH for 36" Spillway
- 1 Year Limited Warranty
- 12" Spillway: 4 per Master Carton. 24" Spillway: 2 per Master Carton 36" Spillway: 1 per Master Carton



Explore infinite color possibilities w/ adjustable settings



Choose from 8 scenes; Night, Reading, Party, Leisure, Soft, Rainbow, Shine & Gorgeous

PROLINE APP-CONTROLLED MULTI-COLOR LED SPILLWAYS



PROLINE APP-CONTROLLED 24" MULTI-COLOR LED SPILLWAY - ITEM# 03702



EXPLORE INFINITE COLOR POSSIBILITIES ALL FROM YOUR PHONE

PROLINE APP-CONTROLLED 12" MULTI-COLOR LED SPILLWAY - ITEM# 03701



PROLINE APP-CONTROLLED 36" MULTI-COLOR LED SPILLWAY - ITEM# 03703



SCAN CODE USING YOUR SMART DEVICE CAMERA. THIS WILL DIRECTLY TAKE YOU TO THE APPLE APP STORE OR GOOGLE PLAY STORE TO DOWNLOAD SMART LIFE FOR FREE.



ALSO WORKS WITH VOICE CONTROL



Smart Life and its logo is a registered trademark of Smart Inc., Apple, App Store and its logos are registered trademarks of Apple Inc., Amazon, Alexa, Echo and its logos are registered trademarks of Amazon.com, Inc., Google Play, Home, Assistant and its logos are registered trademarks of Google LLC. All Rights Reserved.

Supreme AQUARIUM



SUPREME® AQUA-MAG® MAGNETIC DRIVE WATER PUMPS

SUPREME® AQUA-MAG 2 TO 36 SERIES PUMPS have been designed to handle virtually any application where water has to be moved. They have been fulfilling the needs of professionals and hobbyists for over 20 years with efficient, quiet and reliable 24/7 performance. Aqua-Mags are ideal in either saltwater or freshwater environments and operate equally well in-line or submerged. With only one moving part, a magnetically driven impeller and an epoxy-encased power unit, there's never a fear that they will contaminate the water with harmful oils or chemicals.



FEATURES

- Reusable Debris Pre-Filter
- Operates Submerged or In-Line
- 10' Grounded Power Cord
- Energy Efficient
- Models 2, 3, 5 and 7 - 1/2" FPT Inlet, MPT Outlet
- Models 9.5, 12 and 18 - 3/4" FPT Inlet, MPT Outlet
- Model 24 and 36 - 1" FPT Inlet, MPT Outlet
- Packed 6 per Master Carton (250 to 700)
- Packed 2 per Master Carton (950 to 3600)
- 5 Year Limited Warranty



AQUA-MAG 250 Maximum Flow Rate	ITEM# 02512 250 GPH
AQUA-MAG 350 Maximum Flow Rate	ITEM# 02513 350 GPH
AQUA-MAG 500 Maximum Flow Rate	ITEM# 02515 500 GPH
AQUA-MAG 700 Maximum Flow Rate	ITEM# 02517 700 GPH
AQUA-MAG 950 Maximum Flow Rate	ITEM# 02710 950 GPH

AQUA-MAG 1200 Maximum Flow Rate	ITEM# 02712 1200 GPH
AQUA-MAG 1800 Maximum Flow Rate	ITEM# 02718 1800 GPH
AQUA-MAG 2400 Maximum Flow Rate	ITEM# 02740 2400 GPH
AQUA-MAG 3600 Maximum Flow Rate	ITEM# 02745 3100 GPH

PUMPING SPECIFICATIONS

MODEL	ITEM#	WATTS	FLOW AT 1'	FLOW AT 2'	FLOW AT 3'	FLOW AT 4'	FLOW AT 5'	FLOW AT 6'	FLOW AT 7'	FLOW AT 8'	FLOW AT 9'	FLOW AT 10'	FLOW AT 15'	SHUTOFF (FEET)
250 GPH	02512	24	280	230	170	130	65	25	-	-	-	-	-	6' 5"
350 GPH	02513	35	420	375	325	280	235	190	140	90	30	-	-	10' 4"
500 GPH	02515	45	525	450	400	350	300	235	200	150	95	-	-	10' 6"
700 GPH	02517	70	655	605	565	530	450	420	325	275	200	110	-	11' 8"
950 GPH	02710	93	1010	930	900	840	770	710	650	600	530	475	-	13' 7"
1200 GPH	02712	110	1190	1130	1065	940	900	840	795	730	630	570	-	13' 7"
1800 GPH	02718	145	1300	1240	1170	1130	1040	1015	925	880	810	775	470	16' 6"
2400 GPH	02740	237	2400	2350	2190	2030	1860	1730	1645	1510	1395	1380	830	17' 1"
3600 GPH	02745	256	3060	2885	2775	2670	2595	2480	2365	2295	2205	2170	1615	22' 6"

SUPREME® AQUA-MAG® AIR FRACTIONATING WATER PUMPS

Supreme AQUARIUM

SUPREME® AQUA MAG AIR FRACTIONATING WATER PUMPS have been designed specifically for use in saltwater and freshwater aquariums. They feature a powerful ceramic magnet with an aerating impeller and a front-mount adjustable venturi inlet with noise-suppressing muffler. Quiet and energy-efficient, Supreme Aqua-Mag utility pumps have been used for over 20 years in homes and professional installations all over the country. The aerating ceramic/magnetic impeller found in all our reliable Air Fractionating Water Pumps makes them particularly ideal for all saltwater applications.

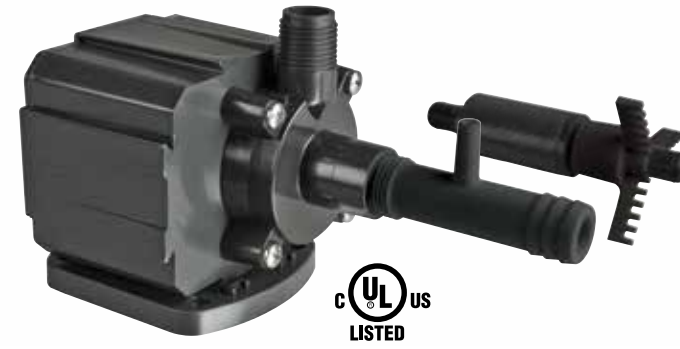

FEATURES

- Front-Mount Adjustable Venturi
- Unique Ceramic Shaft Fractionating Impeller Design
- 18" Vinyl Aerating Tube with Noise-Suppressing Muffler
- Reusable Debris Pre-Filter
- Operates Submerged or In-Line
- 10' Grounded Power Cord
- Models 2, 3, 5 and 7 - 1/2" FPT Inlet, MPT Outlet and Venturi is Barbed to Accept 3/4" Flexible Tubing.
- Models 9.5, 12 and 18 have 3/4" FPT Inlet, MPT Outlet and Venturi is Barbed to Accept 1" Flexible Tubing
- Packed 6 per Master Carton (250 to 700)
- Packed 2 per Master Carton (950 to 1800)
- 5 Year Limited Warranty

MODEL 2 Maximum Flow Rate	ITEM# 06002 250 GPH
MODEL 3 Maximum Flow Rate	ITEM# 06003 350 GPH
MODEL 5 Maximum Flow Rate	ITEM# 06005 500 GPH
MODEL 7 Maximum Flow Rate	ITEM# 06007 700 GPH

MODEL 9.5 Maximum Flow Rate	ITEM# 06010 950 GPH
MODEL 12 Maximum Flow Rate	ITEM# 06012 1200 GPH
MODEL 18 Maximum Flow Rate	ITEM# 06018 1800 GPH

AIR FRACTIONATING WATER PUMP SPECIFICATIONS

PUMP	MAX. OUTPUT		MAX. PUMP HEIGHT		WATTS
	GPH	LITERS	FEET	METERS	
MODEL 2	250	940	6' 4"	1.95	21
MODEL 3	350	1300	10' 3"	3.15	37
MODEL 5	500	1900	10' 5"	3.20	49
MODEL 7	700	2650	11' 7"	3.55	60
MODEL 9.5	950	3595	13' 6"	4.15	93
MODEL 12	1200	4500	13' 6"	4.15	110
MODEL 18	1800	6800	16' 5"	5.00	150

Flow rates above indicate full flow with no aeration introduced into the return water flow. As more air is introduced through the venturi assembly, flow rates will decrease.

THE AQUARIUM PUMP

FOR FRESHWATER AND SALTWATER AQUARIUMS

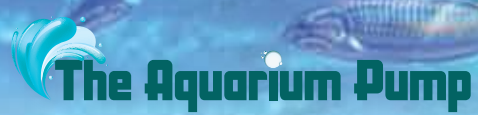

93 GPH thru 725 GPH Pump

Shown with In-line Volute



70 GPH Pump

FEATURES

- For Fresh & Saltwater Aquariums
- New Vertical Flow Control Design Increases Flow Range
- Energy-Efficient Magnetic Drive Technology
- Models 70 thru 200 for Submersible Use Only
Models 290 thru 725 for Submersible or In-line Use
- 6' Grounded Power Cord
- Packed 6 Per Master Carton (70 to 200)
- Packed 4 Per Master Carton (290 to 725)
- 2 Year Limited Warranty



70 GPH PUMP ITEM# 06503

Maximum Flow Rate	70 GPH
Maximum Pumping Height	2'
Cord Length	6'
Includes Slip-Fit Tubing Adapters	1/4" and 1/2"

93 GPH PUMP ITEM# 06507

Maximum Flow Rate	93 GPH
Maximum Pumping Height	2.5'
Includes Slip-Fit Tubing Adapters	1/4" and 1/2"

120 GPH PUMP ITEM# 06513

Maximum Flow Rate	120 GPH
Maximum Pumping Height	3'
Includes Slip-Fit Tubing Adapters	1/4" and 1/2"

200 GPH PUMP ITEM# 06517

Maximum Flow Rate	200 GPH
Maximum Pumping Height	5.6'
Includes Slip-Fit Tubing Adapters	1/4" and 1/2"

290 GPH PUMP ITEM# 06523

Maximum Flow Rate	290 GPH
Maximum Pumping Height	6.5'
Inlet Size	1/2" MPT
Includes Threaded Tubing Adapters	1/2", 5/8" and 3/4"

400 GPH PUMP ITEM# 06527

Maximum Flow Rate	400 GPH
Maximum Pumping Height	8.5'
Inlet Size	1/2" MPT
Includes Threaded Tubing Adapters	1/2", 5/8" and 3/4"

530 GPH PUMP ITEM# 06533

Maximum Flow Rate	530 GPH
Maximum Pumping Height	9'
Inlet Size	1/2" MPT
Includes Threaded Tubing Adapters	1/2", 5/8" and 3/4"

725 GPH PUMP ITEM# 06537

Maximum Flow Rate	725 GPH
Maximum Pumping Height	12'
Inlet Size	1/2" MPT
Includes Threaded Tubing Adapters	1/2", 5/8" and 3/4"

MODEL	FLOW AT 0'	FLOW AT 2'	FLOW AT 4'	FLOW AT 6'	FLOW AT 8'	SHUTOFF	WATTS	AMPS
70 GPH	70	-	-	-	-	2'	3W	.03A
90 GPH	93	20	-	-	-	2.5'	6W	.07A
120 GPH	120	50	-	-	-	3'	6.5W	.08A
200 GPH	200	140	85	35	-	5.6'	14W	.19A
290 GPH	290	270	205	50	-	6.5'	17W	.24A
400 GPH	400	360	285	155	30	8.5'	30W	.45A
530 GPH	530	500	420	305	135	9'	50W	.68A
725 GPH	725	690	615	515	420	12'	70W	.50A

SUPREME HY-DRIVE MAGNETIC DRIVE WATER PUMP

FOR FRESHWATER AQUARIUMS

Supreme AQUARIUM



FEATURES

- For Freshwater Aquariums*
- Powerful, Efficient Hybrid Magnetic/Direct Drive Motor
- Energy-Efficient to Reduce Operating Cost
- Whisper-Quiet Operation
- Specifically Designed for Freshwater Aquariums
- Oil-Free / Fish Safe
- Continuous Duty Operation
- Integrated Filter Screen for Clog-Resistant Operation
- 20' Power Cord with Grounded Plug
- In-line and Submersible Operation
- Convenient Base Plate Included
- 1600, 2100 and 2600 - 1" Female Threaded Inlet, Male Threaded Outlet
- 3200, 4000 and 4800 - 1.5" Female Threaded Inlet, Male Threaded Outlet
- 6000 - 2" Female Threaded Inlet, Male Threaded Outlet
- Packed 2 Per Master Carton
- 3 Year Limited Warranty



1600 HY-Drive Pump

Maximum Flow Rate

ITEM# 02583

1600 GPH

4000 HY-Drive Pump

Maximum Flow Rate

ITEM# 02575

4000 GPH

2100 HY-Drive Pump

Maximum Flow Rate

ITEM# 02582

2100 GPH

4800 HY-Drive Pump

Maximum Flow Rate

ITEM# 02570

4800 GPH

2600 HY-Drive Pump

Maximum Flow Rate

ITEM# 02581

2600 GPH

6000 HY-Drive Pump

Maximum Flow Rate

ITEM# 02572

6000 GPH

3200 HY-Drive Pump

Maximum Flow Rate

ITEM# 02580

3200 GPH

HY-DRIVE PUMPING SPECIFICATIONS

MODEL	ITEM#	NOMINAL	AMPS	WATTS	GPH AT 0'	GPH AT 1'	GPH AT 3'	GPH AT 5'	GPH AT 7'	GPH AT 10'	GPH AT 15'	GPH AT 20'	GPH AT 25'	SHUTOFF
1600	02583	1600	1.0 A	120	1750	1700	1575	1400	1250	1000	375	-	-	17'
2100	02582	2100	1.5 A	190	2125	2075	1900	1750	1600	1300	850	300	-	22.5'
2600	02581	2600	2.2 A	270	2700	2550	2525	2450	2225	1975	1625	1250	300	26.5'
3200	02580	3200	1.6 A	160	3500	3300	2700	2050	1650	650	-	-	-	12'
4000	02575	4000	1.9 A	230	4300	4000	3300	2700	2350	1475	-	-	-	13'
4800	02570	4800	2.0 A	250	5100	5000	4500	3900	3150	2350	800	-	-	18.5'
6000	02572	6000	5.5 A	675	5700	5500	5100	4700	4200	3400	2450	1150	-	22.5'

*Not for use in Saltwater Aquariums

SUPREME® EZ CLEAN EXTERNAL FILTER

FOR FRESHWATER AND SALTWATER AQUARIUMS

1 INNOVATIVE WATER-CHANGE FEATURE

REMOVES AND REFILLS AQUARIUM WATER



2 BUILT-IN GRAVEL CLEANER

SAFELY AND EASILY PULLS DEBRIS FROM GRAVEL WHILE RETURNING FILTERED WATER BACK TO AQUARIUM



3 COMPLETE WATER FILTRATION

FILTER MECHANICALLY, CHEMICALLY & BIOLOGICALLY



EZ CLEAN EXTERNAL FILTER ITEM# 01105

- Patented All-In-One Filter with Built-in Gravel Vacuum
- Dual Cartridge System with Replaceable Media (See Page 70 for Replacement Media)
- No Need to Purchase a Separate Siphon for Water Change
- Gravel Cleaner Includes Flexible Tubing and Mesh Filter Bag
- Can Be Used with Fresh or Saltwater Aquariums up to 55 Gallons
- Product Dimensions: 10 7/8" W x 5 1/2" D x 8 3/4" H for the filter in the tank without intake tube. With intake tube attached the height goes from 8 3/4" to 14" H
- Weight: 3.37 lbs
- Packed 2 Per Master Carton



SUPREME® EZ CLEAN INTERNAL FILTERS

FOR FRESHWATER AND SALTWATER AQUARIUMS

Supreme AQUARIUM

1 INNOVATIVE WATER-CHANGE FEATURE

REMOVES AQUARIUM WATER

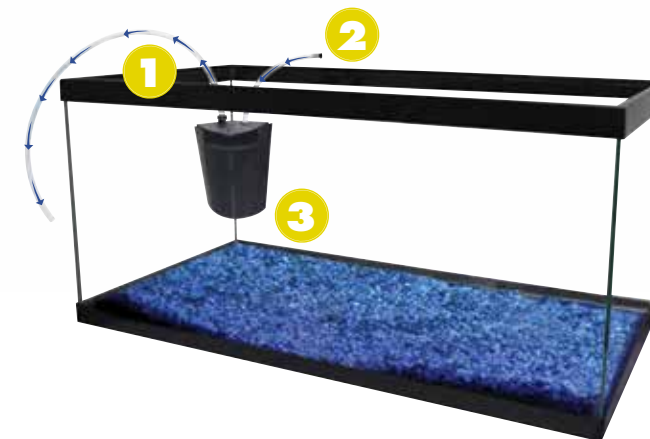

2 ADJUSTABLE AERATION VENTURI

ALLOWS FOR AERATION FLOW CONTROL

3 COMPLETE WATER FILTRATION

FILTER MECHANICALLY, CHEMICALLY & BIOLOGICALLY!



Dual Internal Filter

DUAL INTERNAL FILTER ITEM# 01160

- Patented Dual Cartridge System with Replaceable Media (See Page 70 for Replacement Media)
- No Need to Purchase a Separate Siphon for Water Change
- Unique Top Loading Cartridge Design
- Can be used with Fresh or Saltwater Aquariums up to 55 Gallons
- Product Dimensions: 7" W x 4 3/4" D x 8 1/2" H for the filter in the tank without intake tube. With intake tube attached the height goes from 8 1/2" to 14" H
- Weight: 2.6 lbs
- Packed 2 Per Master Carton

SINGLE INTERNAL FILTER ITEM# 01155

- Patented Single Cartridge System with Replaceable Media (See Page 70 for Replacement Media)
- No Need to Purchase a Separate Siphon for Water Change
- Unique Top Loading Cartridge Design
- Can be used with Fresh or Saltwater Aquariums up to 30 Gallons
- Product Dimensions: 6" W x 4" D x 8 1/2" H for the filter in the tank without intake tube. With intake tube attached the height goes from 8 1/2" to 14" H
- Weight: 2.32 lbs
- Packed 2 Per Master Carton

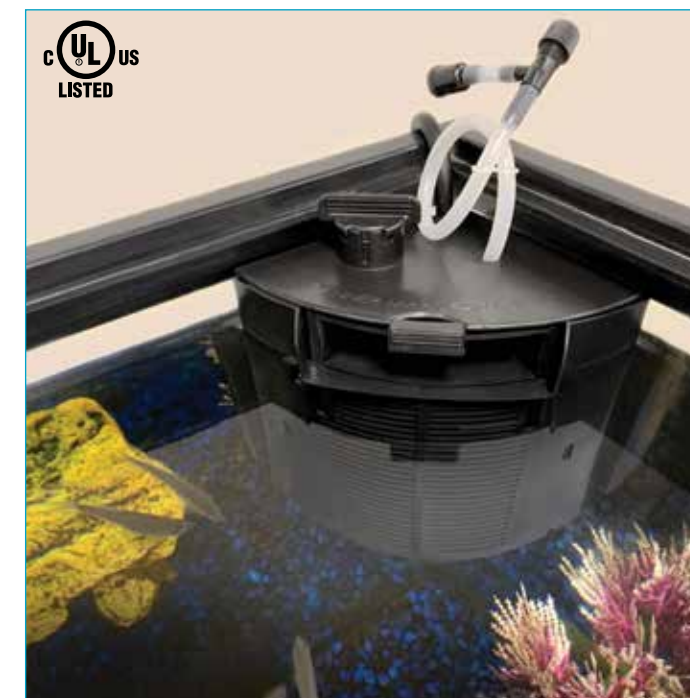

Single Internal Filter



SUBSCRIBE TO OUR YOUTUBE CHANNEL AND VIEW OUR EZ CLEAN FILTER PRODUCT VIDEOS!

WWW.YOUTUBE.COM/DANNERMFG

SUPREME® SKILTER™ PROTEIN SKIMMERS

FOR SALTWATER AQUARIUMS

THE PATENTED SUPREME SKILTER™ IS A UNIQUE COMBINATION of a protein skimmer and an aerating power filter for use in saltwater aquariums. It's an effective primary or supplemental filter along with its operation as a skimmer.

The advanced venturi-type protein skimmer reflects the latest technology. Air is injected into the water creating millions of very fine bubbles. Potentially dangerous protein compounds and toxins adhere to the bubbles creating a froth. This frothy waste pushes its way up into the collection tray where it can be harmlessly disposed of.

The Skilter is built on a basic power filter platform. It features a large filter box, which can accommodate supplemental filter media in conjunction with the unique Bio-Matrix filter cartridge. It is powered by a powerful state-of-the-art motor using a single moving part. It is energy-efficient and economical to operate. Manufactured from high impact plastic, the Skilter will give years of trouble-free operation, even in the adverse conditions which are common to saltwater aquariums.

SKILTER 250

ITEM# 01031

This unit is ideal as a primary filter for aquariums from 10-55 gallons and can be used as a supplemental filter on larger aquariums. The protein skimmer will operate effectively on aquariums up to 125 gallons. The Skilter 250 has an effective flow rate of up to 250 gallons per hour. It is packaged complete and ready-to-go including a Bio-Matrix dual-media filter cartridge. Made in the USA. Packed 6 Per Master Carton.



SKILTER 400

ITEM# 01033

The Skilter 400 is the largest Skilter offered. It is ideal as a primary filter for aquariums up to 30 to 100 gallons and can be used as a supplemental filter on larger aquariums. The protein skimmer is effective for aquariums up to 125 gallons. The larger, powerful motor is rated for a flow of up to 400 gallons per hour. The Skilter 400 is packed with two dual-media Bio-Matrix cartridges. Made in the USA. Packed 6 Per Master Carton.



SUPREME® OVATION

SUBMERSIBLE POWER JET FILTERS

FOR AQUARIUMS AND TERRARIUMS

Supreme AQUARIUM

THE OVATION FILTRATION PUMPS have been designed for hobbyists looking for powerful, quiet and effective filtration for their home aquariums and terrariums. They can be used for installations from 10 to 80 gallons if used singly, or larger installations if more than one pump is employed. They offer the right combination of mechanical, biological and chemical filtration to assure a clean habitat for aquatic pets.

Each Ovation Series pump includes an adjustable spray bar, an airflow regulator and two filtration elements (a sponge and a carbon filter). Units can be mounted vertically or, for terrariums, in a low-profile horizontal position using the included suction cups.



FEATURES

- Innovative Design Filters up to 265 GPH
- Dual Filter Elements Provide Excellent Filtration
- Adjustable Air Regulator Allows Aeration Flow Control
- Includes Spray Bar for Enhanced Aeration
- Mounts Easily for Submersed use in any Terrarium or Aquarium
- Can be Operated in any Position, Horizontal or Vertical
- Smooth, Ultra-Quiet Operation
- Perfect for Odd-Shaped and Shallow Habitats
- Packed 12 Per Master Carton

Ovation-210

Maximum Flow Rate
Recommended Tank Size*

ITEM# 01025

53 GPH
Up to 15 Gallons

Ovation-380

Maximum Flow Rate
Recommended Tank Size*

ITEM# 01026
100 GPH
Up to 25 Gallons

Ovation-700

Maximum Flow Rate
Recommended Tank Size*

ITEM# 01027

185 GPH
Up to 50 Gallons

Ovation-1000

Maximum Flow Rate
Recommended Tank Size*

ITEM# 01028

265 GPH
Up to 80 Gallons

*Single filter use. You may use more than one filter for larger tanks.

SUPREME® OXY-FLO HIGH VOLUME AQUARIUM AIR PUMPS

FOR FRESHWATER & SALTWATER AQUARIUMS

SUPREME OXY-FLOW HIGH VOLUME AIR PUMPS are available in larger volume sizes: AP-20, AP-40, AP-60 and AP-100. All Supreme Air Pumps achieve high output by using a time-proven diaphragm design. Supreme Air Pumps can be used for large or multiple aquarium aeration and filtration due to their larger air output.

FEATURES

- Easy-to-Use Air Pump that Provides Oxygen to Freshwater and Saltwater Aquariums
- Quiet and Reliable Operation
- Energy-Efficient Motor
- High Volume, Diaphragm-Driven Pump has Steady Air Flow and Requires No Lubrication
- Great for Indoor Gardening (Hydroponic) Systems
- Packed 2 Per Master Carton
- 1 Year Limited Warranty



AP-20	ITEM# 04220
Air Volume	1700 cu.in/min
Maximum Water Depth	7'
Noise Level	40 dba
Watts	20
Weight	5 lbs
Air Manifold Outlets	6
Pressure	4.0 psi
Liters	28 L/min.
Dimensions (L x W x H)	8 1/2" x 5 1/2" x 6"
Cord Length	6'

Note: Can Accept 5/8" I.D. Tubing to Extend Distance between Air Pump and Diffuser

AP-40	ITEM# 04240
Air Volume	2900 cu.in/min
Maximum Water Depth	9.6'
Noise Level	40 dba
Watts	40
Weight	9 lbs
Air Manifold Outlets	12
Pressure	4.85 psi
Liters	47 L/min.
Dimensions (L x W x H)	9 5/8" x 6 5/8" x 7"
Cord Length	6'

Note: Can Accept 5/8" I.D. Tubing to Extend Distance between Air Pump and Diffuser

AP-60	ITEM# 04260
Air Volume	5500 cu.in/min
Maximum Water Depth	10'
Noise Level	45 dba
Watts	60
Weight	14 lbs
Air Manifold Outlets	14
Pressure	5.66 psi
Liters	90 L/min.
Dimensions (L x W x H)	10" x 7 1/2" x 8 1/2"
Cord Length	6'

Note: Can Accept 3/4" I.D. Tubing to Extend Distance between Air Pump and Diffuser

AP-100	ITEM# 04280
Air Volume	9150 cu.in/min
Maximum Water Depth	11.5'
Noise Level	45 dba
Watts	100
Weight	16.5 lbs
Air Manifold Outlets	33
Pressure	6.53 psi
Liters	150 L/min.
Dimensions (L x W x H)	11 3/4" x 8" x 8 7/8"
Cord Length	6'

Note: Can Accept 3/4" I.D. Tubing to Extend Distance between Air Pump and Diffuser

FOR A COMPLETE LIST OF REPLACEMENT DIAPHRAGM KITS AND MANIFOLDS VISIT WWW.DANNERMFG.COM

SUPREME® OXY-FLOW LOW VOLUME AQUARIUM AIR PUMPS

FOR FRESHWATER & SALTWATER AQUARIUMS

Supreme AQUARIUM

AQUA-SUPREME AIR PUMPS are available in four low volume sizes: AP-2, AP-3, AP-4 and AP-8. These beautifully designed, low energy pumps can be used for oxygenating aquariums to help promote healthier fish and aquatic plant life, along with helping breakdown fish waste so that it can be collected with the use of a protein skimmer.

FEATURES

- Easy-to-Use Air Pump that Provides Oxygen to Freshwater and Saltwater Aquariums
- Quiet and Reliable Operation
- Accepts Standard Airline Tubing
- Great for Indoor Gardening (Hydroponic) Systems
- Packed 4 Per Master Carton (AP-2, AP-3 and AP-4)
- Packed 2 Per Master Carton (AP-8)

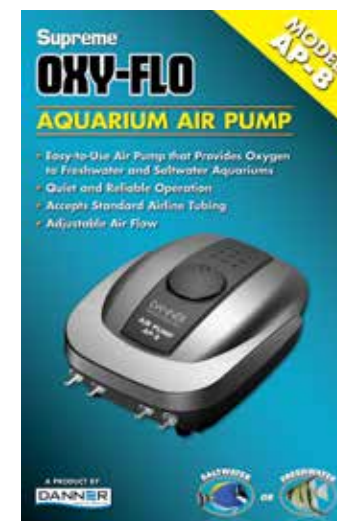

AP-2	ITEM# 06402
Air Volume	73 cu.in/min
Maximum Water Depth	3'
Cord Length	6'
Number of Outlets	1
Watts	1.5
Pressure	0.010 MPa (1.45 psi)

AP-3	ITEM# 06403
Air Volume	110 cu.in/min
Maximum Water Depth	3.3'
Cord Length	6'
Number of Outlets	1
Watts	2.8
Pressure	0.010 MPa (1.45 psi)

AP-4	ITEM# 06404
Air Volume	275 cu.in/min
Maximum Water Depth	4'
Cord Length	6'
Number of Outlets	2, Flow Adjustable
Watts	3.5
Pressure	0.014 MPa (2.0 psi)

AP-8	ITEM# 06408
Air Volume	549 cu.in/min
Maximum Water Depth	4.5'
Cord Length	6'
Number of Outlets	4, Flow Adjustable
Watts	7
Pressure	0.014 MPa (2.0 psi)

FOR A COMPLETE LIST OF REPLACEMENT DIAPHRAGM KITS VISIT WWW.DANNERMFG.COM

LIFE INSURANCE FOR YOUR PUMP!

READY-TO-USE CLEANER for Aquariums and Aquarium Pumps. It's a biodegradable, safe cleaner formulated to rapidly dissolve all types of mineral scale, lime and rust from equipment used in Aquariums. Safe for use with plastic, ceramic, rubber, PVC, titanium, copper, nickel and short-term use with stainless steel.* It can be used to thoroughly clean an entire Aquarium, as long as all inhabitants and/or plants are removed prior to use and any spent cleaner is thoroughly mixed with water.

4 OZ. SUPREME PUMPGUARD

ITEM# 06331

32 OZ. SUPREME PUMPGUARD

ITEM# 06335

- Instantly Loosens Mineral Scale, Lime, Rust and Other Detritus from Aquarium Water Pumps
- Keeps Your Water Pump Operating Properly and Efficiently
- Fast and Easy to Use
- Biodegradable
- Not for use on Aluminum surfaces
- 4 oz. Packed 12 Per Master Carton
- 32 oz. Packed 6 Per Master Carton

BEFORE PUMPGUARD™

AFTER PUMPGUARD™



16 OZ. SUPREME AQUA-CLEAN TRIGGER SPRAY

ITEM# 06337

32 OZ. SUPREME AQUA-CLEAN TRIGGER SPRAY

ITEM# 06339

- Instantly Loosens Mineral Scale, Lime, Rust and other Detritus from Aquarium Pumps, Equipment and Surfaces
- Rapidly Removes Coralline Algae and Dissolves Calcium Carbonate
- Effectively Cleans All of the Surfaces of Your Pumps and Aquarium Equipment
- Safe to use on Glass
- Fast and Easy to Use
- Biodegradable
- 16 oz. Packed 12 Per Master Carton
- 32 oz. Packed 6 Per Master Carton



SUPREME REPLACEMENT FILTER MEDIA AND IMPELLERS

SUPREME AQUARIUM PRODUCTS have an extensive line of replacement parts carefully designed to maintain the effectiveness of your filter or pump. When the filter media or pump impeller wears out, we always recommend a genuine and original replacement part for ultimate performance.



AIR STONES

4" Air Stone	ITEM# 14640
6" Air Stone	ITEM# 14645
8" Air Stone	ITEM# 14650

AIRLINE TUBING AND CHECK VALVE

16 Foot 5M Airline Tubing	ITEM# 14625
Airline Check Valve	ITEM# 14635

EZ CLEAN REPLACEMENT CARTRIDGES AND MEDIA

Replacement Filter Media Cartridges for use with all EZ Clean Aquarium Filters, 2 Pack	ITEM# 21155
Replacement Filter Media for use with all EZ Clean Aquarium Filters, 2 Pack	ITEM# 21160

EZ CLEAN REPLACEMENT IMPELLERS

EZ Clean External Filter Impeller Assembly	ITEM# 21135
EZ Clean Internal Filter Impeller Assembly	ITEM# 12655

Ovation MEDIA

Ovation 210 Replacement Media	ITEM# 11725
Ovation 380 Replacement Media	ITEM# 11726
Ovation 700 Replacement Media	ITEM# 11727
Ovation 1000 Replacement Media	ITEM# 11728

BIO-MATRIX CARTRIDGES AND MEDIA

Bio-Matrix Cartridge for Skilter, 1 Pack	ITEM# 11802
Bio-Matrix Cartridges, 4 Pack	ITEM# 11804
Bio-Matrix Media Combo, 12 Carbon, 12 Polyester	ITEM# 11812
4x4 Replacement Bio-Matrix Media, 4 Carbon, 4 Polyester	ITEM# 11844
Polyester Bio-Matrix Media, 12 Pack	ITEM# 11866

Ovation IMPELLERS

Ovation 210 Impeller Assembly	ITEM# 11755
Ovation 380 Impeller Assembly	ITEM# 11756
Ovation 700 Impeller Assembly	ITEM# 11757
Ovation 1000 Impeller Assembly	ITEM# 11758

SKILTER IMPELLERS

Skilter 250	ITEM# 11855
Skilter 400	ITEM# 21855

AQUA-MAG WATER PUMP IMPELLERS

Model 2	Impeller Assembly	ITEM# 12555
Model 3, 5	Impeller Assembly	ITEM# 12575
Model 7	Impeller Assembly	ITEM# 12585
Model 9.5 (B)	Impeller Assembly	ITEM# 12746
Model 12 (B)	Impeller Assembly	ITEM# 12756
Model 18 (B)	Impeller Assembly	ITEM# 12776
Model 24 (A)	Impeller Assembly	ITEM# 12780
Model 24 (B)	Impeller Assembly	ITEM# 12791
Model 36 (A)	Impeller Assembly	ITEM# 12790
Model 36 (B)	Impeller Assembly	ITEM# 12796

FRACTIONATING WATER PUMP IMPELLERS

Models 2, 3, 5, 7	Venturi Assembly with Tubing and Muffler	ITEM# 16505
Model 2	Fractionating Impeller Assembly	ITEM# 16555
Model 3, 5	Fractionating Impeller Assembly	ITEM# 16575
Model 7	Fractionating Impeller Assembly	ITEM# 16585
Models 9.5, 12, 18	Venturi Assembly with Tubing and Muffler	ITEM# 16705
Model 9.5	Fractionating Impeller Assembly	ITEM# 16745
Model 12	Fractionating Impeller Assembly	ITEM# 16755
Model 18	Fractionating Impeller Assembly	ITEM# 16775

FOR A COMPLETE LIST OF REPLACEMENT FILTER MEDIA AND IMPELLER ASSEMBLIES VISIT WWW.DANNERMFG.COM

*Not for use on aluminium, magnesium or Air Stones.

SUPREME® "LET'S GET STARTED" PLAN-O-GRAMS

A POWERFUL SELLING AID

WE'VE LOADED THESE DYNAMIC DISPLAYS with the energy-efficient pumps, air pumps and filters you'll need to satisfy most home and professional aquarium applications. Supreme "Let's Get Started" Plan-o-Grams are available in 2', 3' and 4' Sizes.

SUPREME® "LET'S GET STARTED" PLAN-O-GRAMS

Supreme AQUARIUM



*Please See Your Danner Representative for Details.

2 FOOT PLAN-O-GRAM			3 FOOT PLAN-O-GRAM			4 FOOT PLAN-O-GRAM		
TOP SHELF			TOP SHELF			TOP SHELF		
ITEM	ITEM#	QTY	ITEM	ITEM#	QTY	ITEM	ITEM#	QTY
The Aquarium Pump, 70 GPH	06503	6	The Aquarium Pump, 120 GPH	06513	6	The Aquarium Pump, 70 GPH	06503	6
The Aquarium Pump, 120 GPH	06513	6	The Aquarium Pump, 290 GPH	06523	4	The Aquarium Pump, 120 GPH	06513	6
						The Aquarium Pump, 290 GPH	06523	4
2ND SHELF			2ND SHELF			2ND SHELF		
ITEM	ITEM#	QTY	ITEM	ITEM#	QTY	ITEM	ITEM#	QTY
Aqua-MAG Water pump, 350 GPH	02513	6	Aqua-MAG Water Pump, 500 GPH	02515	6	Aqua-MAG Water Pump, 350 GPH	02513	6
Aqua-MAG Water Pump, 500 GPH	02515	6	Aqua-MAG Water pump, 950 GPH	02710	2	Aqua-MAG Water Pump, 500 GPH	02515	6
						Aqua-MAG Water pump, 950 GPH	02710	2
3RD SHELF			3RD SHELF			3RD SHELF		
ITEM	ITEM#	QTY	ITEM	ITEM#	QTY	ITEM	ITEM#	QTY
Aqua-Supreme Air Pump, AP-2	06402	4	Aqua-Supreme Air Pump, AP-4	06404	4	Aqua-Supreme Air Pump, AP-2	06402	4
Aqua-Supreme Air Pump, AP-3	06403	4	Aqua-Supreme Air Pump, AP-8	06408	2	Aqua-Supreme Air Pump, AP-3	06403	4
Aqua-Supreme Air Pump, AP-4	06404	4	Aqua-Supreme Air Pump, AP-20	04220	2	Aqua-Supreme Air Pump, AP-4	06404	4
						Aqua-Supreme Air Pump, AP-8	06408	2
						Aqua-Supreme Air Pump, AP-20	04220	2
						Aqua-Supreme Air Pump, AP-60	04260	2
4TH SHELF			4TH SHELF			4TH SHELF		
ITEM	ITEM#	QTY	ITEM	ITEM#	QTY	ITEM	ITEM#	QTY
Ovation Power Jet Filter 210	01025	12	Ovation Power Jet Filter 380	01026	12	Ovation Power Jet Filter 210	01025	12
Ovation Power Jet Filter 380	01026	12	Ovation Power Jet Filter 700	01027	12	Ovation Power Jet Filter 700	01027	12
Ovation Power Jet Filter 700	01027	12	Ovation Power Jet Filter 1000	01028	12	Ovation Power Jet Filter 1000	01028	12
5TH SHELF			5TH SHELF			5TH SHELF		
ITEM	ITEM#	QTY	ITEM	ITEM#	QTY	ITEM	ITEM#	QTY
EZ Clean External Aquarium Filter	01105	2	EZ Clean External Aquarium Filter	01105	2	EZ Clean External Aquarium Filter	01105	2
EZ Clean Internal Aquarium Filter, Single Filter	01155	4	EZ Clean Internal Aquarium Filter, Dual Filter	01160	4	EZ Clean Internal Aquarium Filter, Single Filter	01155	4
						EZ Clean Internal Aquarium Filter, Dual Filter	01160	4

Supreme HYDRO[®]

SUPREME HYDRO-MAG RECIRCULATING WATER PUMPS

FEATURES

- Models 2 through 18 incorporate an adjustable Venturi which adds Aeration into the nutrient rich water flow, stimulating root growth.
- 10' Power Cord on all models
- Time proven Magnetic Drive Technology
- Energy efficient and Oil-Free
- In-line or Submersible Operation
- Models 2 through 7 include 1/2" Male NPT Outlet
- Models 9.5 through 18 include 3/4" Male NPT Outlet
- Models 24 and 36 include 1" Male NPT Outlet
- Packed 4 Per Master Carton (1.9)
- Packed 6 Per Master Carton (2, 3, 5 and 7)
- Packed 2 Per Master Carton (9.5, 12, 18, 24 and 36)
- 5 Year Limited Warranty



Model 7



Model 24

MODEL 1.9 ITEM# 40120

Maximum Flow Rate 190 GPH
Watts/Amps 19/0.3

3/8" MPT Inlet and 1/4" MPT Outlet

MODEL 2 WITH VENTURI ITEM# 40122

Maximum Flow Rate 250 GPH
Watts/Amps 24/0.4

1/2" FPT Inlet and MPT Outlet

MODEL 3 WITH VENTURI ITEM# 40123

Maximum Flow Rate 350 GPH
Watts/Amps 35/0.6

1/2" FPT Inlet and MPT Outlet

MODEL 5 WITH VENTURI ITEM# 40125

Maximum Flow Rate 500 GPH
Watts/Amps 45/0.9

1/2" FPT Inlet and MPT Outlet

MODEL 7 WITH VENTURI ITEM# 40127

Maximum Flow Rate 700 GPH
Watts/Amps 70/1.6

1/2" FPT Inlet and MPT Outlet

MODEL 9.5 WITH VENTURI ITEM# 40129

Maximum Flow Rate 950 GPH
Watts/Amps 93/1.33

3/4" FPT Inlet and MPT Outlet

MODEL 12 WITH VENTURI ITEM# 40132

Maximum Flow Rate 1200 GPH
Watts/Amps 110/1.5

3/4" FPT Inlet and MPT Outlet

MODEL 18 WITH VENTURI ITEM# 40138

Maximum Flow Rate 1800 GPH
Watts/Amps 145/1.55

3/4" FPT Inlet and MPT Outlet

MODEL 24 ITEM# 40140

Maximum Flow Rate 2400 GPH
Watts/Amps 237/2.2

1" FPT Inlet and MPT Outlet

MODEL 36 ITEM# 40145

Maximum Flow Rate 3100 GPH
Watts/Amps 256/3.0

1" FPT Inlet and MPT Outlet



PUMP	SHUT OFF	FLOOD TABLE SIZES							
		2x2	2x3	2x4	3x3	3x6	4x4	8x4	
190 GPH	7'	x							
250 GPH	7'	x	x						
350 GPH	10.5'		x	x					
500 GPH	10.5'			x	x				
700 GPH	11.5'			x	x				
950 GPH	13.5'					x	x		
1200 GPH	13.5'					x	x	x	
1800 GPH	16.5'							x	
2400 GPH	17'							x	
3600 GPH	22.5'							x	

Shut off is the maximum vertical height the pump will pump water. To calculate the pressure (psi), multiply the shut off by .454.

SUPREME HY-DRIVE RECIRCULATING WATER PUMPS

Supreme HYDRO

FEATURES

- Hybrid direct drive design
- Energy Efficient to reduce operating cost
- Oil-Free with no seals to wear out
- Ceramic Shaft and Bearings
- Continuous duty use
- In-line or Submersible operation
- Good for Vertical Grow Applications
- 20' Power Cord on all models
- Packed 2 per Master Carton
- 2 Year Limited Warranty

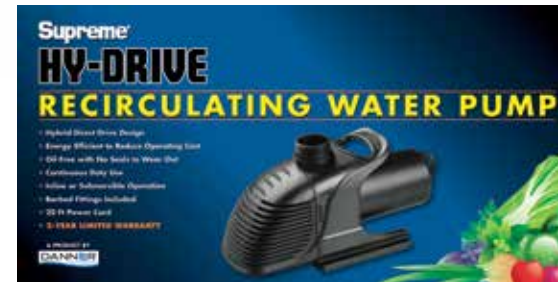

1400 HY-DRIVE PUMP ITEM# 40405

Maximum Flow Rate 1400 GPH
1-1/2" Female Threaded Inlet and Male Threaded Outlet

1900 HY-DRIVE PUMP ITEM# 40415

Maximum Flow Rate 1900 GPH
1-1/2" Female Threaded Inlet and Male Threaded Outlet

2550 HY-DRIVE PUMP ITEM# 40425

Maximum Flow Rate 2550 GPH
1-1/2" Female Threaded Inlet and Male Threaded Outlet

5100 HY-DRIVE PUMP ITEM# 40435

Maximum Flow Rate 5100 GPH
1-1/2" Female Threaded Inlet and Male Threaded Outlet

6600 HY-DRIVE PUMP ITEM# 40445

Maximum Flow Rate 6600 GPH
1-1/2" Female Threaded Inlet and Male Threaded Outlet

7600 HY-DRIVE PUMP ITEM# 40450

Maximum Flow Rate 7600 GPH
2" Female Threaded Inlet and 1-1/2" Male Threaded Outlet

GPH PUMP FLOW VS. PUMPING HEIGHT													
PUMP	ITEM#	WATTS	AMPS	1'	3'	5'	7'	10'	15'	20'	25'	30'	SHUTOFF
1400	40405	150	1.3	1350	1250	1150	1100	950	675	350	-	-	22'
1900	40415	93	.78	1710	1325	870	555	-	-	-	-	-	10'
2550	40425	147	1.3	2380	2010	1490	1045	455	-	-	-	-	11.5'
5100	40435	439	3.6	5100	5050	4650	4375	3900	3050	2375	1675	-	30'
6600	40445	593	4.9	6600	6275	5500	4925	4325	3325	2425	1850	550	30.5'
7600	40450	635	5.3	7440	7210	6690	6170	5525	3805	2640	1310	-	27.5'

To achieve maximum flow from the 5100, 6600 or 7600 GPH pumps, a minimum of 2" ID tubing must be used.

HYDRO-AIR® SUBMERSIBLE WATER & AIR PUMP

THE HYDRO-AIR SUBMERSIBLE WATER & AIR PUMP is a unique patented design that allows water flow and aeration to be produced by one pump. With a dual-ended impeller design, this energy efficient design fulfills two functions with one product. The pump is completely epoxy-encased so there's never a fear that it will contaminate the water with harmful oils or chemicals.



WATER ON ONE SIDE

OXYGEN ON THE OTHER



FEATURES

- One Electrical outlet needed for both Water and Air
- Custom Diffuser disperses a wide band of Air Bubbles
- Ceramic Shaft
- Aerates up to 1,000 gallons
- Can be used in depths up to 2-Feet
- Pumps up to 1400 gallons per hour
- (2) Pre-Filters Included
- 8 1/4" L x 3 3/4" W x 5 1/2"H without Diffuser (6 1/2" H with Diffuser)
- 18' Grounded Power Cord
- 1 Year Limited Warranty

HYDRO-AIR SUBMERSIBLE WATER & AIR PUMP ITEM# 02795

- 17 Ft. Shut-Off with 1-1/2" Tubing
- 16 Ft. Shut-Off with 2" Tubing
- 120 Volts AC, 60 HZ, 199 Watts, 3.7 Amps.

ON WATER PUMP SIDE:

- 3/4" FPT Inlet
- 3/4" MPT Outlet

ON AIR PUMP SIDE:

- Requires 1/2" PVC Tubing on the Inlet (Sold Separately)
- Air Diffuser on the Outlet (included)

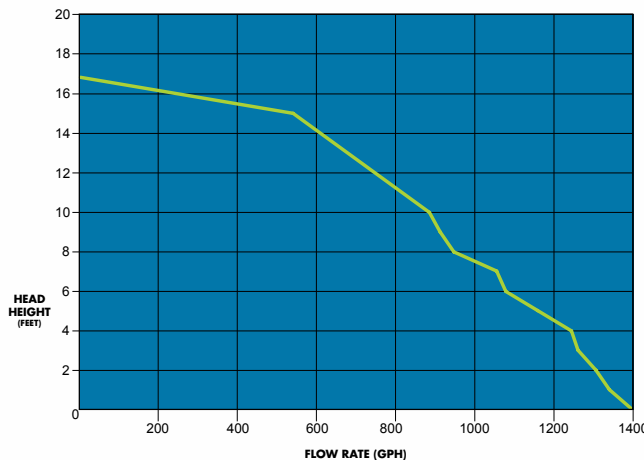

THE GROWER'S PUMP



FEATURES

- 70 GPH to 200 GPH Models are designed for Submersible use and 290 GPH to 725 GPH Models can be used Submersible or In-line
- Suitable for Ebb & Flow applications
- Adjustable Flow Control if used Submersed
- Energy Efficient
- 6' Power Cord
- Oil-Free Design
- Packed 6 Per Master Carton (70, 93, 120 and 200)
- Packed 4 Per Master Carton (290, 400, 530 and 725)
- 2 Year Limited Warranty

70 GPH Pump ITEM# 40303

Maximum Flow	70 GPH
Maximum Pumping Height	2'
Watts/Amps	3/0.3
Includes Slip-Fit Tubing Adapters	1/4" and 1/2"

93 GPH Pump ITEM# 40307

Maximum Flow	93 GPH
Maximum Pumping Height	2.5'
Watts/Amps	6/0.7
Includes Slip-Fit Tubing Adapters	1/4" and 1/2"

120 GPH Pump ITEM# 40313

Maximum Flow	120 GPH
Maximum Pumping Height	3'
Watts/Amps	6.5/0.8
Includes Slip-Fit Tubing Adapters	1/4" and 1/2"

200 GPH Pump ITEM# 40317

Maximum Flow	200 GPH
Maximum Pumping Height	5.6'
Watts/Amps	14/0.19
Includes Slip-Fit Tubing Adapters	1/4" and 1/2"

290 GPH Pump ITEM# 40323

Maximum Flow	290 GPH
Maximum Pumping Height	6.5'
Watts/Amps	17/0.24
Inlet Size	1/2" MPT
Includes Threaded Tubing Adapters	1/2", 5/8" and 3/4"

400 GPH Pump ITEM# 40327

Maximum Flow	400 GPH
Maximum Pumping Height	8.5'
Watts/Amps	30/0.45
Inlet Size	1/2" MPT
Includes Threaded Tubing Adapters	1/2", 5/8" and 3/4"

530 GPH Pump ITEM# 40333

Maximum Flow	530 GPH
Maximum Pumping Height	9'
Watts/Amps	50/0.68
Inlet Size	1/2" MPT
Includes Threaded Tubing Adapters	1/2", 5/8" and 3/4"

725 GPH Pump ITEM# 40337

Maximum Flow	725 GPH
Maximum Pumping Height	12'
Watts/Amps	70/0.50
Inlet Size	1/2" MPT
Includes Threaded Tubing Adapters	1/2", 5/8" and 3/4"



70 GPH Pump



200 GPH Pump



725 GPH Pump Shown with In-Line Volute



PUMP	SHUT OFF	FLOOD TABLE SIZES						
		2x2	2x3	2x4	3x3	3x6	4x4	8x4
70 GPH	2'	x						
93 GPH	2.5'	x						
120 GPH	3'	x	x					
200 GPH	5.6'	x	x					
290 GPH	6.5'		x	x				
400 GPH	8.5'			x	x			
530 GPH	9'			x	x			
725 GPH	12'				x	x	x	

Shut off is the maximum vertical height the pump will pump water. To calculate the pressure (psi), multiply the shut off by .454.



SUBSCRIBE TO OUR YOUTUBE CHANNEL AND VIEW OUR HYDRO-AIR PRODUCT VIDEO!

WWW.YOUTUBE.COM/DANNERMFG

SUPREME CLONING PUMP WITH SPRAY HEAD

FEATURES

- Designed Specifically for Plant Cloning
- 24" - 30" Diameter Spray
- Energy Efficient
- Oil-Free
- Packed 4 Per Master Carton
- 6' Power Cord
- 1 Year Limited Warranty

CLONING 155 GPH PUMP WITH TUBE AND SPRAY HEAD

ITEM# 40355

Maximum Flow Rate	155 GPH
Watts	14

REPLACEMENT COVER (Not Shown)

ITEM# 48310

REPLACEMENT PRE-FILTER (Not Shown)

ITEM# 17505



SUPREME DE-WATERING PUMPS

Supreme HYDRO

SUPREME DE-WATERING PUMP is a powerful, durable, oil free pump that can remove water down to 1/8 of an inch from any medium to large grow tray or nutrient tank. With a maximum flow rate of 1900 GPH and included adapters for a 3/4" garden hose and a 1 1/2" vacuum hose fitting, it can quickly drain down grow systems for cleaning. It can also quickly remove water from a variety of common and emergency de-watering applications such as flooded basements, rooftops or anywhere that de-watering is a must.

DE-WATERING PUMP

ITEM# 40465

Weight	8 lbs.
Outlet	1" FNPT
Watts	370 Max
Amps	4A Max
Shut Off Height	24'
Max Flow Rate with 3/4" Garden Hose	1400 GPH
Max Flow Rate with 1-1/2" Pool Hose	1900 GPH

FEATURES

- Lightweight
- Removes Water to 1/8"
- Easily Attaches to Garden Hose
- Sturdy, Integrated Carry Handle
- Completely Submersible
- Removable Screened Inlet
- High Impact Thermoplastic Housing
- 1/2 HP Oil-Free Motor with Thermal Protection
- Garden Hose Fittings Included
- 25' Cord with Strain Relief
- Packed 2 Per Master Carton
- Not for Continuous Duty
- 1 Year Limited Warranty*



Item# 40465 Shown with Outlet Fittings: 1/2" Hose Fitting and 3/4" GHT Fitting (both included)



300 GPH DE-WATERING PUMP

ITEM# 40460

Weight	2.75 lbs.
Outlet	3/4" Garden Hose Thread (GHT)
Watts	18 Max
Amps	.2A Max
Shut Off Height	6'
Max Flow Rate	300 GPH
Master Carton Quantity	4

*1 Year Limited Warranty does not include external attachments.

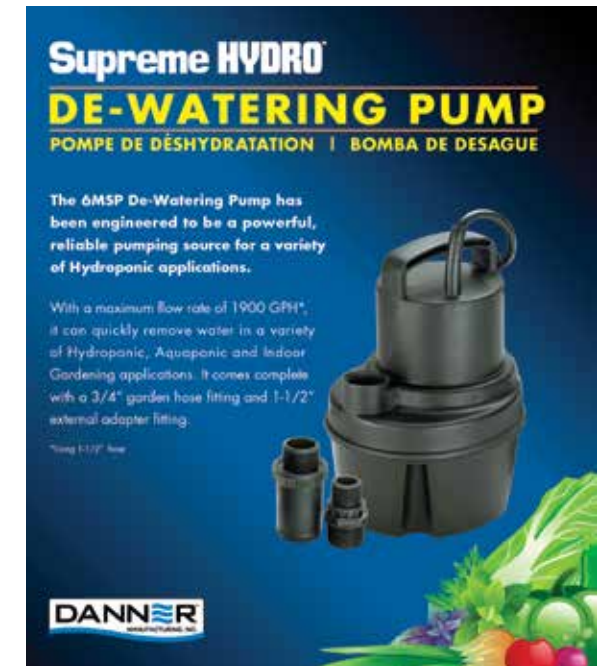

SUPREME OXY-FLO HIGH VOLUME AIR PUMPS

FEATURES

- Energy Efficient Motor
- Easy to Use
- Quiet Operation
- High Volume with Steady Air Flow
- No Lubrication Necessary
- Single Outlet Discharge
- Air Manifold (included)
- Accepts Standard 3/16" Airline Tubing (not included)
- Packed 2 Per Master Carton
- 1 Year Limited Warranty



AP-20	ITEM# 40522
Air Volume	1700 cu.in/min
Maximum Water Depth	7'
Noise Level	40 dba
Watts	20
Weight	5 lbs
Air Manifold Outlets	6
Pressure	4.0 psi
Liters	28 L/min.
Dimensions (L x W x H)	8 1/2" x 5 1/2" x 6"
Cord Length	6'

Note: Can Accept 5/8" I.D. Tubing to Extend Distance between Air Pump and Manifold

AP-40	ITEM# 40524
Air Volume	2900 cu.in/min
Maximum Water Depth	9.6'
Noise Level	40 dba
Watts	40
Weight	9 lbs
Air Manifold Outlets	12
Pressure	4.85 psi
Liters	47 L/min.
Dimensions (L x W x H)	9 5/8" x 6 5/8" x 7"
Cord Length	6'

Note: Can Accept 5/8" I.D. Tubing to Extend Distance between Air Pump and Manifold

AP-60	ITEM# 40526
Air Volume	5500 cu.in/min
Maximum Water Depth	10'
Noise Level	45 dba
Watts	60
Weight	14 lbs
Air Manifold Outlets	14
Pressure	5.66 psi
Liters	90 L/min.
Dimensions (L x W x H)	10" x 7 1/2" x 8 1/2"
Cord Length	6'

Note: Can Accept 3/4" I.D. Tubing to Extend Distance between Air Pump and Manifold

AP-100	ITEM# 40528
Air Volume	9150 cu.in/min
Maximum Water Depth	11.5'
Noise Level	45 dba
Watts	100
Weight	16.5 lbs
Air Manifold Outlets	33
Pressure	6.53 psi
Liters	150 L/min.
Dimensions (L x W x H)	11 3/4" x 8" x 8 7/8"
Cord Length	6'

Note: Can Accept 3/4" I.D. Tubing to Extend Distance between Air Pump and Manifold

FOR A COMPLETE LIST OF REPLACEMENT DIAPHRAGM KITS AND MANIFOLDS VISIT WWW.DANNERMFG.COM

SUPREME OXY-FLO LOW VOLUME AIR PUMPS

Supreme HYDRO



FEATURES

- Aerates Nutrients to Stimulate Root Growth
- Energy-Efficient Design
- Easy to Use
- Quiet Operation
- Accepts Standard 3/16" Airline Tubing
- 1 Year Limited Warranty

AP-2	ITEM# 40512
Air Volume	73 cu.in/min
Maximum Water Depth	3'
Number of Outlets	1
Watts	1.5
Pressure	0.010 MPa (1.45 psi)
Cord Length	6'

AP-3	ITEM# 40513
Air Volume	110 cu.in/min
Maximum Water Depth	3.3'
Number of Outlets	1
Watts	2.8
Pressure	0.010 MPa (1.45 psi)
Cord Length	6'

AP-4	ITEM# 40514
Air Volume	275 cu.in/min
Maximum Water Depth	4'
Number of Outlets	2, Flow Adjustable
Watts	3.5
Pressure	0.014 MPa (2.0 psi)
Cord Length	6'

AP-8	ITEM# 40518
Air Volume	549 cu.in/min
Maximum Water Depth	4.5'
Number of Outlets	4, Flow Adjustable
Watts	7
Pressure	0.014 MPa (2.0 psi)
Cord Length	6'

LIFE INSURANCE FOR YOUR PUMP!

READY-TO-USE CLEANER FOR HYDROPONIC PUMPS AND EQUIPMENT. It is a biodegradable, safe cleaner formulated to rapidly dissolve all types of mineral scale, lime, and rust from equipment used in Hydroponics. Safe for use with plastic, ceramic, rubber, PVC, titanium, copper, nickel and short-term use with stainless steel.*

It can be used to thoroughly clean a Hydroponic set up as long as plants are removed prior to use and any spent cleaner is thoroughly mixed with water. Everything must be rinsed and flushed before returning plants.

FEATURES

- Instantly loosens Mineral Scale, Lime, Rust and other Detritus from Hydroponic Pumps, Equipment, Trays and Surfaces
- Effectively cleans all of the surfaces of your Pumps and Hydroponics equipment
- Fast and easy to use
- Biodegradable

16 OZ. TRIGGER SPRAY **ITEM# 40775**

- Packed 12 Per Master Carton

32 OZ. TRIGGER SPRAY **ITEM# 40779**

- Packed 6 Per Master Carton

32 OZ. BOTTLE **ITEM# 40781**

- Packed 6 Per Master Carton

1 GALLON BOTTLE **ITEM# 40783**

- Packed 4 Per Master Carton



FINALLY... AN EASY MAINTENANCE SOLUTION TO KEEP YOUR PUMP RUNNING LIKE NEW!

BEFORE HYDRO-CLEAN™



AFTER HYDRO-CLEAN™



*Not for use on aluminium, magnesium or Air Stones.

6" STRAIGHT AIR DIFFUSER
ITEM# 14570

- Adapts to 5/8" Tubing
- Includes Nylon Bag to Weight down Diffuser
- Packed 6 Per Master Carton



6" STRAIGHT AIR DIFFUSER WITH TUBING
ITEM# 14575

- Includes 20' of 5/8" Tubing
- Includes Nylon Bag to Weight down Diffuser
- Packed 1 Per Master Carton



7" DIAMETER RING AIR DIFFUSER
ITEM# 14580

- Adapts to 5/8" Tubing
- Includes Nylon Bag to Weight down Diffuser
- Packed 6 Per Master Carton

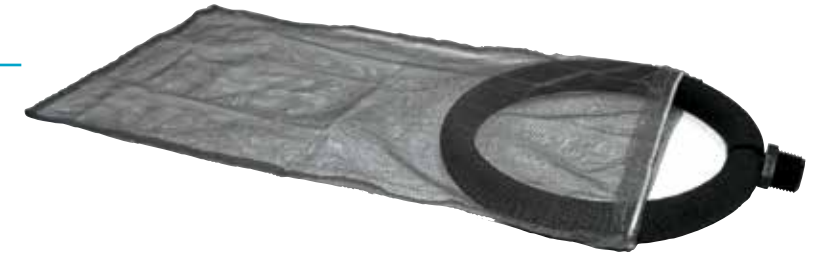

SUPREME EBB & FLOW KIT

THIS INNOVATIVE DESIGN makes adjusting the height of your Ebb & Flow fittings easier than ever while bringing convenience to your garden. Simply position the neck of the fill/drain screens to the desired height and then twist to lock into place. This allows you to easily adjust the fill height of the water in the flood table.

EBB AND FLOW KIT **ITEM# 49922**

- Includes (2) 2-1/2" and (1) 8" Long Adjustable Fill/Drain Screens
- 1/2" Barbed Fill Fitting
- 3/4" Barbed Drain Fitting
- Packed 6 Per Master Carton
- Patent Pending



SUBSCRIBE TO OUR YOUTUBE CHANNEL AND VIEW OUR EBB & FLOW PRODUCT VIDEOS!

WWW.YOUTUBE.COM/DANNERMFG

AIR STONES

4" AIR STONE ITEM# 14664

- Fits Standard 3/16" Airline Tubing
- Packed 12 Per Master Carton

6" AIR STONE ITEM# 14645

- Fits Standard 3/16" Airline Tubing
- Packed 12 Per Master Carton

8" AIR STONE ITEM# 14650

- Fits Standard 3/16" Airline Tubing
- Packed 12 Per Master Carton



TUBING AND CHECK VALVES

5M 16' AIRLINE TUBING ITEM# 14625

- Packed 12 Per Master Carton

AIRLINE CHECK VALVE ITEM# 14635

- Packed 12 Per Master Carton

1/2" X 10' STANDARD BLACK TUBING ITEM# 12012

- Packed 6 Per Master Carton



SUPREME REPLACEMENT PARTS

Supreme HYDRO

Venturi Assembly with Tubing and Muffler for Pump Models 2 to 7	ITEM# 16505	Fractionating Impeller Assembly for Pump Model 2	ITEM# 16555
Venturi Assembly with Tubing and Muffler for Pump Models 9.5 to 18	ITEM# 16705	Fractionating Impeller Assembly for Pump Models 3 and 5	ITEM# 16575
Small Pre-filter for Pump Models 2, 3, 5 and 7	ITEM# 12505	Fractionating Impeller Assembly for Pump Model 7	ITEM# 16585
Foam Filter Replacement for Model 1.9 - 2 Pack	ITEM# 12605	Fractionating Impeller Assembly for Pump Model 9.5	ITEM# 16745
Large Pre-filter for Pump Models 2, 3, 5 & 7	ITEM# 12285	Fractionating Impeller Assembly for Pump Model 12	ITEM# 16755
Foam Pre-filter for Pump Models 9.5, 12 and 18	ITEM# 12730	Fractionating Impeller Assembly for Pump Model 18	ITEM# 16775
Replacement Impeller for 70 GPH Grower's Pump	ITEM# 21705	Replacement Rotor for 1900 HY-Drive Pump	ITEM# 21005
Replacement Impeller for 93 GPH Grower's Pump	ITEM# 21710	Replacement Rotor for 1400 HY-Drive Pump	ITEM# 21105
Replacement Impeller for 120 GPH Grower's Pump	ITEM# 21715	Replacement Rotor for 2550 HY-Drive Pump	ITEM# 21110
Replacement Impeller for 200 GPH Grower's Pump	ITEM# 21720	Replacement Rotor for 5100 HY-Drive Pump	ITEM# 21115
Replacement Impeller for 290 GPH Grower's Pump	ITEM# 21725	Replacement Rotor for 6600 HY-Drive Pump	ITEM# 21025
Replacement Impeller for 400 GPH Grower's Pump	ITEM# 21730	Replacement Rotor for 7600 HY-Drive Pump	ITEM# 21120
Replacement Impeller for 530 GPH Grower's Pump	ITEM# 21735	Replacement Impeller for 300 GPH Utility Pump	ITEM# 21555
Replacement Impeller for 725 GPH Grower's Pump	ITEM# 21740	Replacement Diaphragm Assembly for AP-4 and AP-8 Air Pumps	ITEM# 14605
Impeller/Mag for Pump Model 1.9	ITEM# 12955	Replacement Manifold for AP-20 Air Pump	ITEM# 14505
Impeller/Mag for Pump Model 2	ITEM# 12555	Replacement Manifold for AP-40 Air Pump	ITEM# 14515
Impeller/Mag for Pump Models 3 and 5	ITEM# 12575	Replacement Manifold for AP-60 Air Pump	ITEM# 14550
Impeller/Mag for Pump Model 7	ITEM# 12585	Replacement Manifold for AP-100 Air Pump	ITEM# 14560
Impeller/Mag for Pump Model 9.5 (B)	ITEM# 12746	Diaphragm Kit for AP-20 Air Pump	ITEM# 14525
Impeller/Mag for Pump Model 12 (B)	ITEM# 12756	Diaphragm Kit for AP-40 Air Pump	ITEM# 14545
Impeller/Mag for Pump Model 18 (B)	ITEM# 12776	Diaphragm Kit for AP-60 Air Pump	ITEM# 14555
Impeller/Mag for Pump Model 24 (A)	ITEM# 12780	Diaphragm Kit for AP-100 Air Pump	ITEM# 14565
Impeller/Mag for Pump Model 24 (B)	ITEM# 12791		
Impeller/Mag for Pump Model 36 (A)	ITEM# 12790		
Impeller/Mag for Pump Model 36 (B)	ITEM# 12796		
Impeller/Mag for Hydro-Air™	ITEM# 12972		

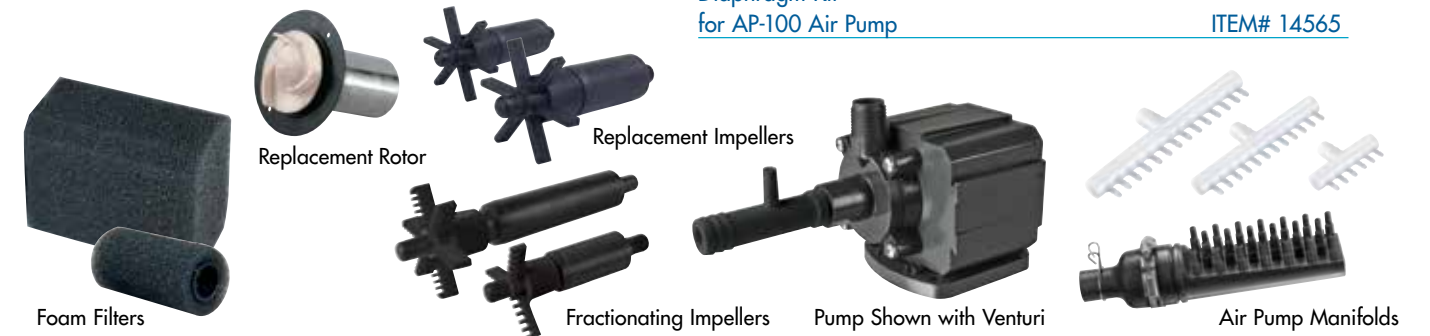

FOR A COMPLETE LIST OF REPLACEMENT PARTS VISIT WWW.DANNERMFG.COM





POOL CARE

BY DANNER MANUFACTURING

COVER-CARE MAGNETIC DRIVE POOL COVER PUMPS

COVER-CARE MAGNETIC DRIVE POOL COVER PUMPS makes opening up the backyard pool easy when winter is over. They're clog resistant and available in three different pumping capacities to easily accommodate virtually any size pool cover.

FEATURES

- Magnetic Drive Motor
- Completely Submersible
- Easily Connects to any Standard 3/4" Garden Hose (Fitting Included)
- 300 GPH: Pumps Down to 1/8" of Water
- 300 GPH: Packed 12 Per Master
- 300 GPH: 1 Year Limited Warranty
- 350 GPH and 500 GPH: Packed 6 Per Master
- 350 GPH and 500 GPH: 5 Year Limited Warranty



02540



02533 | 02555

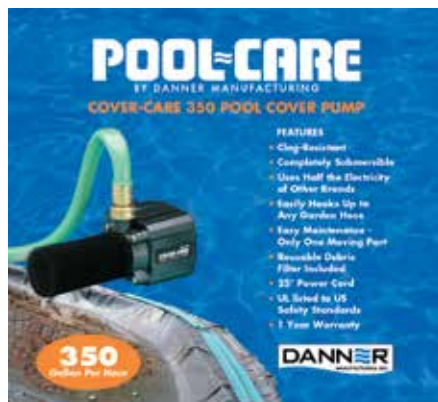

300 GPH COVER-CARE POOL COVER PUMP

ITEM# 02540

Max. Flow Rate	300 GPH
Max. Pumping Height	6'
Cord Length	25'
Max. Watts/Amps	18/0.4
Weight	2.6 lbs.
Dimensions (L x W x H)	5.5" x 4" x 3.75"

350 GPH COVER-CARE POOL COVER PUMP

ITEM# 02533

Max. Flow Rate	350 GPH
Max. Pumping Height	7'
Cord Length	25'
Max. Watts/Amps	24/0.4
Weight	3.6 lbs.
Dimensions (L x W x H)	5.0" x 3.8" x 4.2"

500 GPH COVER-CARE POOL COVER PUMP

ITEM# 02555

Max. Flow Rate	500 GPH
Max. Pumping Height	10.5'
Cord Length	25'
Max. Watts/Amps	45/0.9
Weight	3.75 lbs.
Dimensions (L x W x H)	5.0" x 3.8" x 4.2"



COVER-CARE AUTOMATIC 360 POOL COVER PUMP

COVER-CARE AUTOMATIC 360 POOL COVER PUMP is a completely submersible pump that features an electronic sensor which detects water levels at 2" of depth and turns the pump automatically off. The Automatic 360 Pool Cover Pump also only has one moving part, a magnetically driven motor and easily connects to any standard 3/4" garden hose.

FEATURES

- Electronic Sensor Detects Water Level at 2" Depth and Turns Pump Off Automatically
- Magnetic Drive Motor – Only One Moving Part
- Easily Connects to Any Standard 3/4" Garden Hose Thread
- Includes Easy Clean Clog Resistant Foam Filter
- Completely Submersible
- 9' Maximum Pumping Height
- Includes 1/2" Adapter for Tubing
- Listed to UL Standards
- Packed 4 Per Master Carton
- 1 Year Limited Warranty



Automatic 360 Pool Cover Pump shown with included clog resistant foam filter

360 GPH COVER-CARE AUTOMATIC POOL COVER PUMP - ITEM# 02530

Max. Flow Rate	360 GPH
Max. Pumping Height	9'
Cord Length	25'
Max. Watts/Amp	30/0.6
Weight	3.6 lbs.
Dimensions (L x W x H)	3.75" x 4.25" x 2.75"



POOL-CARE MAIN DRAIN UTILITY/POOL PUMP

MAIN DRAIN UTILITY PUMP is a powerful and durable utility pump that is designed primarily for draining in-ground swimming pools. The slotted "basket" base measures less than 5 1/2-inches in diameter, which allows the pump to fit inside any standard 8" main drain and seat itself several inches below the top surface of the pool's main drain flange. With a maximum flow rate of 5400 GPH, it can quickly and efficiently remove water from any in-ground Swimming Pool.

FEATURES

- Maximum Flow Rate: 5400 GPH or 90 GPM
- Maximum Head Height: 32-feet
- Pumps Down to 2" water depth
- Fits in standard 8" Pool Main Drain Allowing for Complete Drainage
- Includes 1 1/2" Threaded Barbed Fitting
- Removable Elbow for Vertical or Horizontal Discharge Options
- Integrated Carry Handle
- 25' Cord with Flexible Strain Relief
- Completely Submersible
- Slotted Base Constructed from High Impact ABS
- 316 Marine Grade Stainless Steel Hardware
- Optional Tethered Float Switch for Automatic Shut-Off
- Packed 2 per Master Carton
- 1 Year Limited Warranty*



MAIN DRAIN PUMP - ITEM# 20370

Max. Flow Rate	5400 GPH
Max. Pumping Height	32'
Max. Watts/Amps	593/4.9
Weight	12 lbs.
Dimensions w/ Elbow (W x H)	9 3/4" x 15 1/2"
Dimensions w/out Elbow (W x H)	7 1/4" x 15 1/2"

TETHERED FLOAT SWITCH - ITEM# 20375

Cord Length: 30' with Piggy Back Plug



TETHERED FLOAT SWITCH FEATURES

- Mechanically-Activated Snap Action Contacts
- Corrosion Resistant High Impact Polypropylene Float Housing

*1 Year Limited Warranty does not include external attachments.

POOL-CARE 6MSP UTILITY/POOL PUMP



6MSP UTILITY/POOL PUMP is a powerful, durable, oil-free pump that can remove water down to 1/8" of an inch. With a maximum flow rate of 1900 GPH, it can quickly remove water from swimming pools and pool covers. It can also efficiently remove water from a variety of common and emergency de-watering applications such as flooded basements, rooftops or anywhere that de-watering is a must. Fits inside most pool bottoms and 8" main drains and comes complete with adapters for a standard garden hose (3/4") and pool vacuum hose fittings (1 1/2").

FEATURES

- Lightweight
- Pumps Down to 1/8"
- Fits In a 8" Main Drain and Most Pool Bottom Drains
- Sturdy, Integrated Carry Handle
- Completely Submersible
- Removable Screened Inlet
- High Impact Thermoplastic Housing
- 1/6 HP Oil-Free Motor with Thermal Protection
- Garden Hose & Pool Vacuum Hose Fittings Included
- 25' Cord with Strain Relief
- Packed 2 per Master
- 24-Pack Display Pallet
- For Fresh Water Use Only
- Not for Continuous Duty
- 1 Year Limited Warranty*

6MSP UTILITY/POOL PUMP - ITEM# 02585

Max. Flow Rate	1900 GPH
Max. Pumping Height	24'
Max. Watts/Amps	370/4
Weight	8 lbs.
Dimensions (L x W x H)	6.5" x 6.5" x 9"



6MSP Shown with Outlet Fittings — 1/2" Hose Fitting and 3/4" GHT Fitting



Example of 6MSP Utility/Pool Pump Fitting into a Standard Pool Drain



Optional Tethered Float Switch - Item# 20375 can also be used with 6MSP for automatic shut-off



*1 Year Limited Warranty does not include external attachments.

POOL-CARE APP-CONTROLLED MULTI-COLOR LED SPILLWAY



INTRODUCING THE POOL-CARE APP-CONTROLLED MULTI-COLOR LED SPILLWAY

for Inground Pools, Retaining Walls and anywhere else you desire the beauty and tranquility of soothing flowing water. The Pool-Care App-Controlled Multi-Color LED Spillway is iOS and Android compatible using the Smart Life App, which is available for free within the Apple App Store or Google Play Store. Connect to Smart Life utilizing the Spillway's integrated 2.4 GHz WiFi controller (no secondary hub required) to control the lighting within the LED Spillway, now making your mobile device your remote control. This eliminates the need for a separate remote and the hassle of changing batteries or losing it.

Explore the infinite color possibilities within Smart Life and its adjustable color and temperature settings to suit your needs. It features 8 pre-programmed scenes: 4 scenes designed as Night, Reading, Party and Leisure while the other 4 scenes; Soft, Rainbow, Shine and Gorgeous can be adjusted based on your mood. You can also set up multiple schedules to turn the lighting on/off according to your desired preset time. Schedules can be repeated daily or weekly.

Keeping up with current trends, Smart Life also works with voice control via Amazon Echo, Alexa, Google Home and Assistant. You can also add and control multiple LED Spillways at one time within the Smart Life App.

FEATURES

- App-Controlled LED Spillway compatible w/ iOS and Android devices
- Free 'Smart Life' App available in the Apple App Store or Google Play Store
- Your mobile device is your remote control, Eliminates the need for a separate remote
- Connect w/ the Spillways waterproof 2.4 GHz WiFi controller
- Infinite color possibilities w/ adjustable settings
- Works w/ Voice Control via Amazon Echo, Alexa, Google Home and/or Assistant
- Interior baffling system that produces a single, lighted water sheet
- Reinforced opening with 5" Lip Extension
- Bottom Mount with integrated 1 1/2" Female Threaded Connection
- 43' power cord length w/ rain-proof transformer & waterproof WiFi controller
- Recommended pump size: 3600 GPH
- 1 Year Limited Warranty
- Packed 1 per Master Carton



Explore infinite color possibilities w/ adjustable settings



Choose from 8 scenes; Night, Reading, Party, Leisure, Soft, Rainbow, Shine & Gorgeous

POOL-CARE APP-CONTROLLED MULTI-COLOR LED SPILLWAY



POOL-CARE APP-CONTROLLED 36" MULTI-COLOR LED SPILLWAY - ITEM# 10703



EXPLORE INFINITE COLOR POSSIBILITIES ALL FROM YOUR PHONE



SCAN CODE USING YOUR SMART DEVICE CAMERA. THIS WILL DIRECTLY TAKE YOU TO THE APPLE APP STORE OR GOOGLE PLAY STORE TO DOWNLOAD SMART LIFE FOR FREE.



ALSO WORKS WITH VOICE CONTROL



Smart Life and its logo is a registered trademark of Smart Inc., Apple, App Store and its logos are registered trademarks of Apple Inc., Amazon, Alexa, Echo and its logos are registered trademarks of Amazon.com, Inc., Google Play, Home, Assistant and its logos are registered trademarks of Google LLC. All Rights Reserved.

Home Collection



DANNER HOME COLLECTION MEDITATION FOUNTAINS

INTRODUCING THE HOME COLLECTION line of Meditation Fountains by Danner Manufacturing. The Halo, Aura and Pearl Meditation Fountains are stylish pieces of decor that fit on any tabletop, kitchen counter, living room table, bathroom sink, shelf, vanity or office desk while bringing a calm, Zen-like feel to any room in the house or work space.

Turn on the Halo, Aura or Pearl before bedtime and drift off to sleep as you listen to the sound of peaceful running water with its soft glow as a night light. You can even use it while you're meditating, practicing yoga or at the office to center yourself while at work.

HALO & AURA MEDITATION FOUNTAINS INCLUDE:

- Tabletop Meditation Fountain
- Fountain base
- Water Pump
- LED Light
- Decorative Stones
- 6' Power Cord with AC Wall Adapter
(Low Voltage transformer listed to US and Canadian UL standards)
- Each packed 2 Per Master Carton

ENJOY
THE SOOTHING
SOUND OF
FLOWING
WATER



HALO MEDITATION FOUNTAIN
Item# 03802
PRODUCT DIMENSION:
8 1/2" W x 7 3/8" D x 11" H



AURA MEDITATION FOUNTAIN
Item# 03801
PRODUCT DIMENSION:
8 1/2" W x 7 3/8" D x 10 1/8" H



The Pearl Meditation Fountain features a rotating 360° glass pearl that is moved by the pumps water flow. Just place the included glass pearl on top of the fountain base and watch as it rotates while it illuminates from the multi-color LED light from underneath the water.

PEARL MEDITATION FOUNTAIN INCLUDES:

- Tabletop Meditation Fountain
- Glass Pearl
- Fountain base
- Water Pump
- LED Light
- Decorative Stones
- 6' Power Cord with AC Wall Adapter
(Low Voltage transformer listed to US and Canadian UL standards)
- Packed 2 Per Master Carton



PEARL MEDITATION FOUNTAIN
Item# 03800
PRODUCT DIMENSION:
8 1/2" W x 7 3/8" D x 11" H



PERFECT FOR ANY ROOM IN THE HOUSE OR WORK SPACE



SUBSCRIBE TO OUR YOUTUBE CHANNEL AND VIEW OUR MEDITATION FOUNTAIN PRODUCT VIDEOS!
WWW.YOUTUBE.COM/DANNERMFG



A Proud American Manufacturer

160 OVAL DRIVE. ISLANDIA, NY 11749 • 1-800-458-5876

Every effort has been made to assure the information included in this catalog is current and correct at the time of printing. We reserve the right to make product changes without notice and assume no responsibility for typographical errors.



DANNERMFG.COM
@DANNERMFG



CAT-DANNERFULL REV B 07/19