

Nature's Generator

User Manual

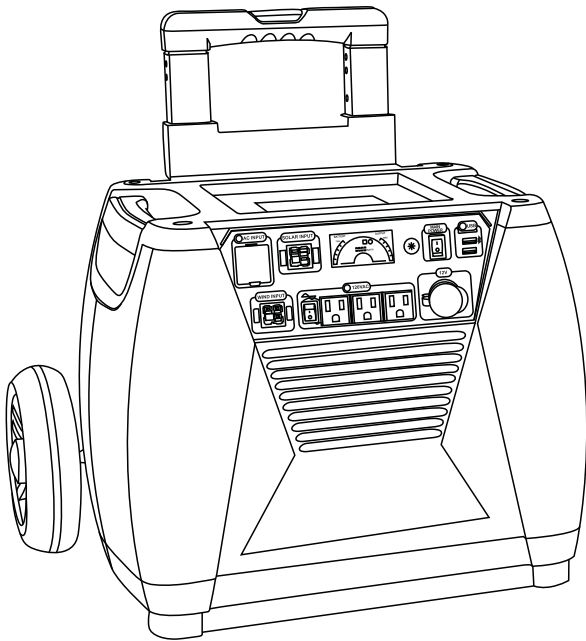

Nature's Generator

The Nature's Smartest, Infinitely Expandable Generator System

Contents

Important Safety Instructions.....	1
- Warning	1
- Caution.....	2
Introduction.....	3
- Unpack Your Nature's Generator.....	3
- Get to Know Your Nature's Generator.....	4
Using Your Nature's Generator	6
- How to Recharge Your Nature's Generator.....	6
- How to Use Your Nature's Generator.....	7
- How to Read the LCD Display	8
- How to Use Your Nature's Generator Smart Key	9
- How to Expand the Capacity of Your Nature's Generator	9
- How to Maintain and Store Your Nature's Generator	9
Troubleshooting	10
Technical Specifications	11
Limited Warranty.....	12

Important Safety Instructions

1. Read these instructions.
2. Keep these instructions.
3. Take care of all warnings.
4. Follow all instructions.
5. Do not use this apparatus near water.
6. Do not block any ventilation openings.
7. Do not use near flammable gases or fumes or other apparatus that produce a large amount of heat.
8. Only use attachments/accessories specified by the manufacturer.
9. Use only with the cart specified by the manufacturer, or sold with the apparatus. When a cart is used, use caution when moving the cart/apparatus combination to avoid injury from tip-over.
10. Refer all servicing to qualified service personnel. Servicing is required when the apparatus has been damaged in any way, such as power-supply cord or plug is damaged, liquid has been spilled or objects have fallen into the apparatus, the apparatus has been exposed to rain or moisture, does not operate normally, or has been dropped.
11. The apparatus should not be exposed to dripping or splashing, and no objects filled with liquids, such as vases, should be placed on the apparatus.

Warning

Electric shock hazard

Keep away from children. Nature's Generator generates the same potentially lethal AC power as a normal household wall outlet. To reduce the risk of fire or electric shock, do not remove any cover or expose the device to rain or moisture. Do not insert foreign objects into the AC Outlet or the ventilation holes.

Explosion hazard

Do not burn or incinerate this item. This item may explode, causing personal injury or damage. Do not use near flammable gases or fumes or other apparatus that produces large amounts of heat.

Lightning hazard

For added protection for your device during a lightning storm, unplug it from the power outlet and disconnect the cables. This helps to prevent property damage and personal injury from lightning and power line surges.

Energy and burn hazard

Nature's Generator has a sealed lead acid battery, which can present a risk of burn from high current because of short-circuit.

Replacement parts

When replacement parts are required, make sure that the service technician uses replacement parts specified by the manufacturer that have the same characteristics as the original part. Unauthorized substitutions may result in fire, electric shock, personal injury, or other hazards.

Safety check

After completing any service or repair to this device, ask the service technician to perform routine safety checks to determine that your Nature's Generator is in correct operating condition.

Servicing

These servicing instructions are for use by qualified service personnel only. To reduce the risk of electric shock, do not perform any servicing other than that contained in the operating instructions unless you are qualified to do so.

Caution

Damage requiring service

Stop using the Nature's Generator and refer servicing to qualified service personnel under the following conditions:

- If liquid has been spilled or objects have fallen into your Nature's Generator.
- If your Nature's Generator has been exposed to rain or water.
- If your Nature's Generator has been dropped or damaged in any way.
- When your Nature's Generator exhibits a distinct change in performance.

Cold weather

Cold temperatures can impact Nature's Generator performance. If you'll be living below freezing, we recommend keeping your Nature's Generator in an insulated location and connected to a solar panel.

End of life directives

Your Nature's Generator may contain materials that are regulated for environmental reasons. Your Nature's Generator also contains materials that can be recycled and reused. To help protect the environment, contact your local authorities for information about disposal or recycling and about finding a recycler in your area before you dispose of your Nature's Generator.

Introduction

Congratulations on your new Nature's Generator, a state-of-art generator that provides reliable power for emergencies, off grid living, or wherever power is needed. With Nature's Generator app NaturesPulse, you can proactively diagnose the system, track the usage and communicate the issues.

Unpack Your Nature's Generator

1. Nature's Generator

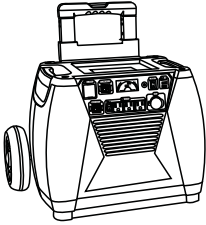

2. AC Power Cord (In the storage compartment)

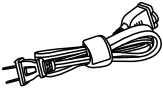

3. Nature's Generator Smart Key



4. This user guide



Get to Know Your Nature's Generator

Front Panel

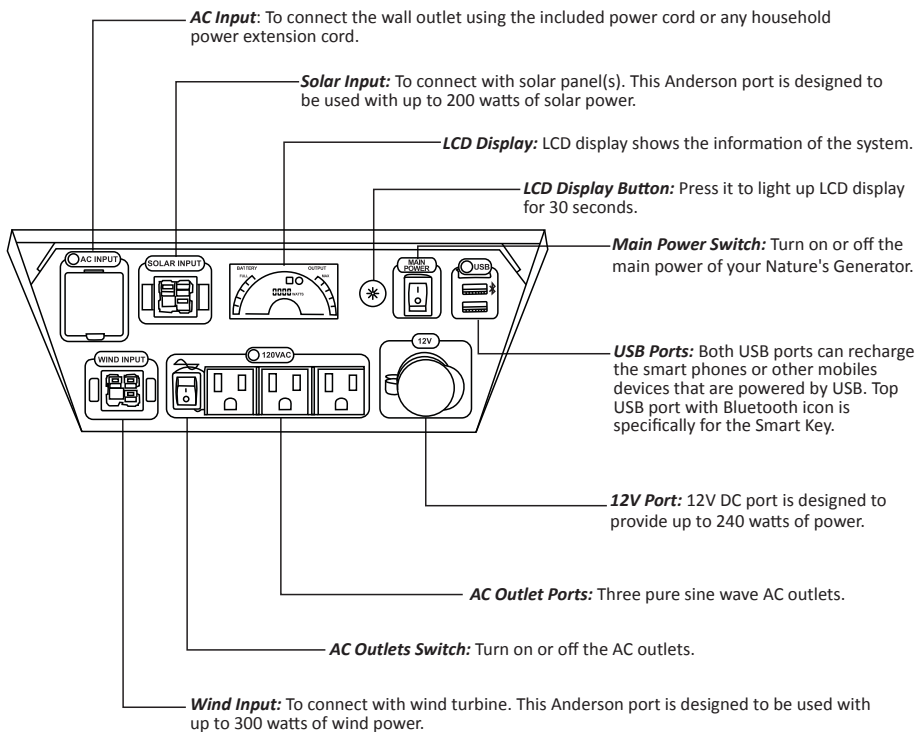

Visit Naturesgenerator.com for More Information

Back Panel

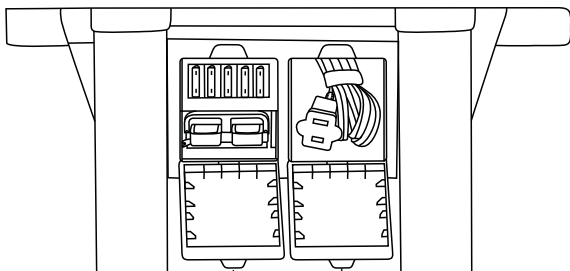

Storage: For storing the power cord.

Expansion cord:
Daisy chaining fuses and Daisy chain connector.

Using Your Nature's Generator

How to Recharge Your Nature's Generator

Recharging from Solar

1. Place your solar panel where it will get as much direct sunlight as possible. While direct sunlight is always preferred, solar panels should be connected at all times to provide a consistent trickle charge to your battery. Solar panels will also send a charge to your unit while in hazy or overcast skies.
2. Insert solar panel plug into Solar Input port on the front of Nature's Generator. You will know it is recharging when LCD display lights up, solar panel icon is illuminated and battery bar starts running. The battery bar stops running when the battery is full or there is not enough power from solar panel.
3. It takes about 10 to 15 hours to recharge Nature's Generator if using 100 watt solar panel, depending on the strength of the sunlight.
4. To increase the recharging speed, you can chain multiple solar panel in parallel connection. The Solar Input port can handle up to 200 watt solar panel. Visit Naturesgenerator.com for information on purchasing additional solar panels.

Recharging from Wind

1. Place your wind turbine where it will get as much wind as possible.
2. Insert wind turbine plug into wind Input port on the front of Nature's Generator. You will know it is recharging when LCD display lights up, wind turbine icon is illuminated and battery bar starts running. The battery bar stops running when the battery is full or there is not enough power from wind turbine.
3. The recharging speed depends on wind turbine power rating and the strength of the wind. The wind input port can handle up to 300 watt wind turbine. Visit Naturesgenerator.com for more information about wind turbine.

Recharging from AC Power

1. Locate the power cord in the storage compartment on the back of the Nature's Generator.
2. Insert the power cord to the AC Input Port of the Nature's Generator.
3. Plug the other end of power cord to the wall outlet. You will know it is recharging when LCD display lights up, AC input icon is illuminated and battery bar starts running. The battery bar stops running when the battery is full.

Recharging from the Car

You can use DC extension cord (not included in the box) to recharge the Nature's Generator by using 12C DC port. This method is not recommended because it recharges much slower and the LCD display doesn't light up.

Visit Naturesgenerator.com for More Information

How to Use Your Nature's Generator

1. Press the Main Power Switch to turn on your Nature's Generator. USB port will be on automatically when Main Power Switch is on.
2. Press the AC Outlet Switch to turn on the AC outlets. When not using AC outlets, make sure to turn off AC outlet switch to conserve power.
3. You'll know the port is turned on when the icon is illuminated on LCD display.
4. Plug in any of your device for power.

Uninterrupted Power Supply (UPS) Mode

1. You can recharge your Nature's Generator and recharge your devices at the same time.
2. If you recharge your Nature's Generator at the same time when you power your AC devices from AC Outlet Ports, your Nature's Generator turns into Uninterrupted Power Supply (UPS) Mode. Your AC devices will receive power directly from the AC outlet. If power goes out, your Nature's Generator will instantly kick on supplying the power for your AC devices.
3. LCD display shows UPS when it is in UPS mode.

How to Read the LCD Display

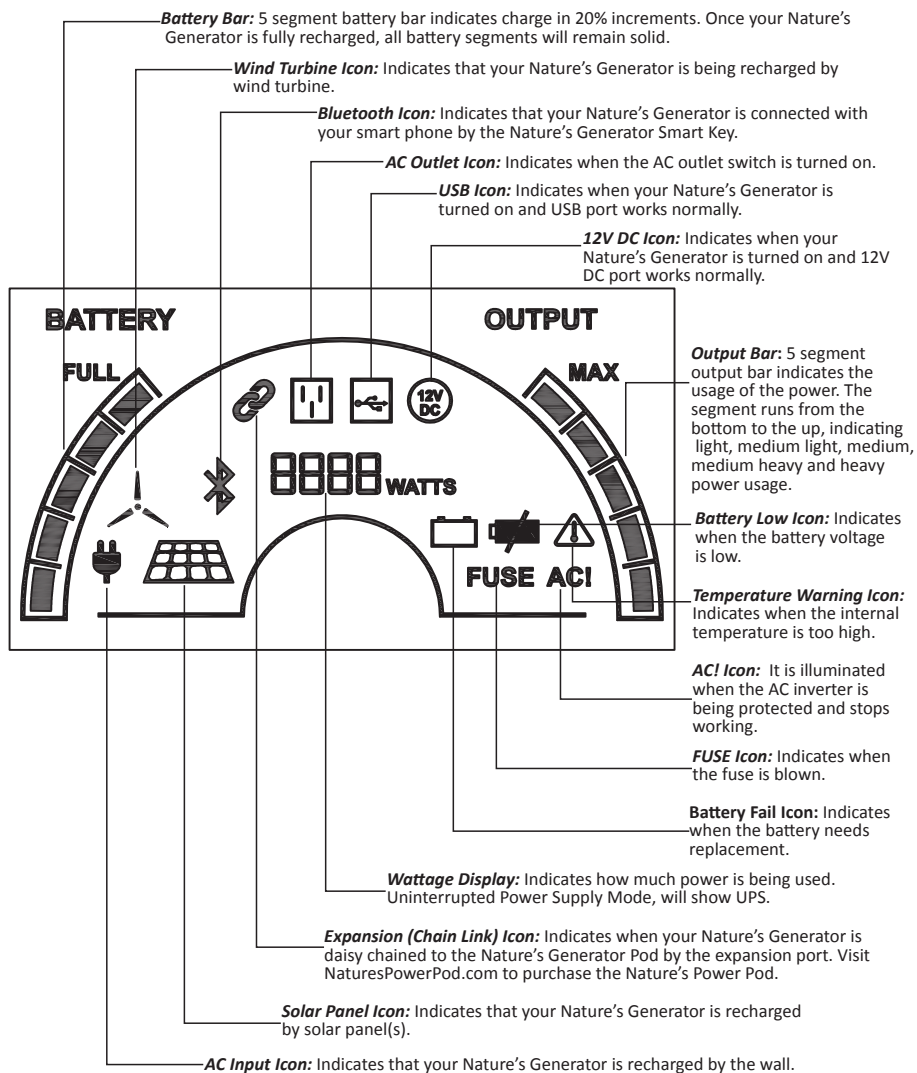

Visit Naturesgenerator.com for More Information

How to Use Your Nature's Generator Smart Key

1. Turn on the main power of your Nature's Generator.
2. Plug your Nature's Generator Smart Key to the top USB port with Bluetooth icon on its right side.
3. If you have not already done so, click App Store on your iPhone or Play Store on your Android Phone.
4. Search "NaturesPulse" app and install it.
5. After the app is installed, please follow the instructions on the app to register your account before you can log into the home page.
6. Press "Connect" button on the home page. The App will search for the Nature's Generator Smart Key and find your Nature's Generator.
7. After it is connected, you can start enjoying the smart features like system diagnosis, history tracking and many more features.

How to Expand the Capacity of Your Nature's Generator

You can extend the run time of your Nature's Generator by connecting it to the Nature's Power Pod. Visit naturesgenerator.com to purchase a Nature's Power Pod.

1. Open the top cover of the Nature's Power Pod, locate the expansion cable, and run the expansion cable out of Nature's Power Pod through the opening on the back of the Pod.
2. Locate Expansion Port on the back of your Nature's Generator and open the rubber cover.
3. Connect the expansion cable to the expansion port.
4. The Expansion (Chain Link) Icon will be illuminated to indicate it is connected.

You will experience an increased run time of approximately 167% by adding one Nature's Power Pod, approximately 333% by adding two Nature's Power Pods and 500% by adding three Nature's Power Pods.

How to Maintain and Store Your Nature's Generator

Please recharge your Nature's Generator once every four months and store in a ventilated, cool and dry location. If possible, please connect your Nature's Generator to a power source, like wall outlet, solar panel or wind turbine while in storage to top off the battery voltage. This keeps battery healthy and prolongs its life. Failure to maintain Nature's Generator by these steps can result in battery damage which will void the product warranty.

Please clean your Nature's Generator with a soft, lint-free cloth. If your Nature's Generator is especially dirty, moisten a soft, lint-free cloth in a weak detergent solution, squeeze the excess moisture from the cloth, then wipe the cabinet with the cloth. Use a clean cloth to dry your Nature's Generator.

Troubleshooting

My Nature's Generator won't charge when I connect my solar panel to it.

Please follow these steps.

1. Make sure the solar panel is pointed directly toward the sun. It is preferred to position the solar panel face the south. The solar panel may produce little or no power if it is positioned in shade.
2. Check the cable connection on Nature's Generator and make sure it fits tightly.
3. If the LCD lights up, but the battery bar is not running. It means Nature's Generator is being fully recharged by the solar panel or solar panel does not have high enough voltage to recharge the Nature's Generator.

My AC device(s) are not powering up from my Nature's Generator.

Please follow these steps:

1. Verify your device is suitable for use with your Nature's Generator. The Nature's Generator AC outputs work only with 120V AC and up to 1800 watts on three outlets combined.
2. Make sure the Main Switch is turned on.
3. Check the battery bar. If there are only three bars or less, recharge your Nature's Generator. Some AC devices pull big power and it is recommended to recharge your Nature's Generator full before heavy use.
4. Make sure the AC outlet switch is turned on. The LED light should be green.
5. If LED light is red, please check the failure icons on the LCD display.
 - a. Battery Fail Icon: replace your battery.
 - b. Battery Low Icon: recharge your battery before use.
 - c. Temperature Warning Icon: The internal temperature is too high. Please let it cool down before use.
 - d. FUSE Icon: Replace the fuses.
 - e. AC! Icon: The AC inverter is being protected. Unplug your AC device, turn off AC outlet switch and back on to try it again.

My Nature's Generator battery drains fast.

Please follow these steps.

1. Check the wattage of AC device(s). Some devices like hair dryer, microwave or vacuum draw big wattage and thus the battery drains fast. Please always monitor the wattage output information on the LCD display.
2. When AC device is not in use, turn off AC outlets of your Nature's Generator to conserve power. The AC outlets consume a considerable amount of power for being ready to use.
3. When Nature's Generator is not in use, turn off the Main Power Switch to shut off the LCD display and USB ports.

Visit Naturesgenerator.com for More Information

Technical Specifications

Battery:

Type: AGM Sealed Lead Acid

Capacity: 60Ah (720Wh)

Self-discharge: Recommend to recharge every 4 months

Inverter:

Output Power: 1800watt max

Output wave form: pure sine wave

Output voltage: 120V

Output frequency: 60Hz

Ports:

USB Port: 5V, up to 3A (15W)

12V DC Port: up to 20A (240W max)

Expansion Port: 200A fuse

Charges:

AC Charger: 90W

AC Charger Indicator: red (charging) and green (charged)

Solar Charger: 200watt

Wind Charger: 300watt

General:

Dimensions: 18 x 12 x 15 in (47 x 30 x 38 cm) without cart

23 x 17 x 22 in (57 x 42 x 55 cm) with cart

Operating temperature: 32-104 °F (0-40 °C)

Storage Temperature: 23–111 °F (-5–45 °C)

Weight: 83 lbs.

Limited Warranty

One Year Limited Warranty

Huntkey USA Inc. warrants to you, the original purchaser of this new product, that the product shall be free of defects in the original manufacture of the material or workmanship for a period of one (1) year from the original date of your purchase of the product (“Warranty Period”). This product must be purchased from an authorized dealer and packaged with this warranty statement. This warranty does not cover refurbished product.

What does this Warranty Cover?

During the Warranty Period, if the original manufacture of the material or workmanship of the product is determined to be defective by an authorized dealer, Huntkey USA Inc. will (at its sole option): (1) repair the product with new or rebuilt parts; or (2) replace the product at no charge with new or rebuilt comparable products or parts. Products and parts replaced under this warranty become the property of Nature's Generator and are not returned to you. If service of products or parts are required after the Warranty Period expires, you must pay all labor and parts charges. This warranty lasts as long as you own your product during the Warranty Period. Warranty coverage terminates if you sell or otherwise transfer the product.

How to Obtain Warranty Service?

Please call 1-805-383-0003 Monday through Friday, 8:30AM to 4:30PM PST. You will be provided with a Return Merchandise Authorization (RMA) number and return instructions. Send product to:

Huntkey USA, Inc.
735 W Ventura Blvd., Suite B
Camarillo, CA 93010

Please include the RMA number prominently displayed on the shipping box and include your name, phone number and address with the product inside the box.

Where is the Warranty Valid?

This warranty is valid only to the original purchaser of the product in North America (United States, Canada and Mexico).

Visit Naturesgenerator.com for More Information

What does the Warranty not Cover?

This warranty does not cover:

- Cosmetic damage
- Damage due to acts of God, such as lightning strikes
- Accident
- Misuse
- Abuse
- Negligence
- Commercial use
- Modification of any part of the product
- Damage due to incorrect operation or maintenance
- Connection to an incorrect voltage supply
- Attempted repair by anyone other than a facility authorized by Huntkey USA Inc. to service the product
- Products sold as is or with all faults
- Consumables, such as batteries
- Products where the factory applied serial number has been altered or removed

REPAIR REPLACEMENT AS PROVIDED UNDER THIS WARRANTY IS YOUR EXCLUSIVE REMEDY. HUNTKEY USA INC. SHALL NOT BE LIABLE FOR ANY INCIDENTAL OR CONSEQUENTIAL DAMAGES FOR THE BREACH OF ANY EXPRESS OR IMPLIED WARRANTY ON THIS PRODUCT, INCLUDING, BUT NOT LIMITED TO LOST DATA, LOSS OF USE OF YOUR PRODUCT, LOST BUSINESS OR LOST PROFITS. HUNTKEY USA INC. PRODUCTS MAKES NO OTHER EXPRESS WARRANTIES WITH RESPECT TO THE PRODUCT, ALL EXPRESS AND IMPLIED WARRANTIES FOR THE PRODUCT, INCLUDING, BUT NOT LIMITED TO, ANY IMPLIED WARRANTIES OF AND CONDITIONS OF MERCHANTABILITY AND FITNESS FOR A PARTICULAR PURPOSE, ARE LIMITED IN DURATION TO THE WARRANTY PERIOD SET FORTH ABOVE AND NO WARRANTIES, WHETHER EXPRESS OR IMPLIED, WILL APPLY AFTER THE WARRANTY PERIOD. SOME STATES, PROVINCES AND JURISDICTIONS DO NOT ALLOW LIMITATIONS ON HOW LONG AN IMPLIED WARRANTY LASTS, SO THE ABOVE LIMITATION MAY NOT APPLY TO YOU. THIS WARRANTY GIVES YOU SPECIFIC LEGAL RIGHTS, AND YOU MAY ALSO HAVE OTHER RIGHTS, WHICH VARY FROM STATE TO STATE OR PROVINCE TO PROVINCE.

Contact Huntkey USA Inc:

For customer service please call 1-805-383-0003

Huntkey USA, Inc.

735 W Ventura Blvd., Suite B

Camarillo, CA 93010



How to Position the Solar Panel

Flat Position
(to mount the solar panel
semi-permanently or during travel)



Winter Position

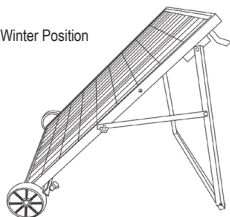

Summer Position

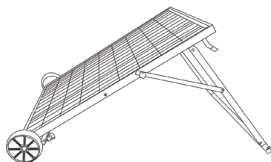

How to Use the Solar Panel

Connect the solar
panel cable to
the solar input
port.

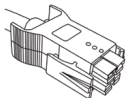

You can use the
four eyebolts to
anchor the solar
panel to the
ground.



You can use 6mm
screw holes on
four aluminum
feet to mount the
solar panel
semi-permanently.

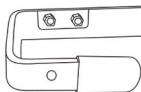

You can turn star
knob clockwise
to stop the wheel
or counterclockwise
to release.

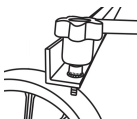

Optional: To Double Charging Speed, Use the Parallel Connection Method

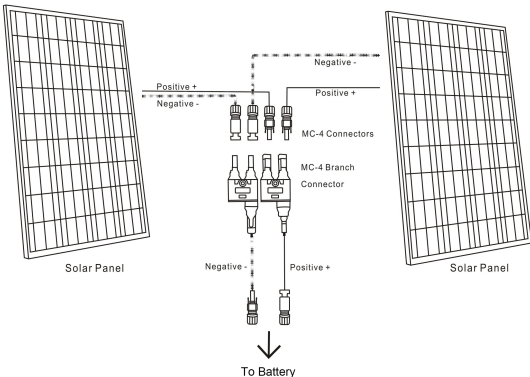

Specifications:

Rated Power: 100W
Open Circuit Voltage: 17.4 ~ 21.6V
Fuse Rating: 8A
Cell: Polycrystalline

Certifications:



Power Transfer Kit

User Manual

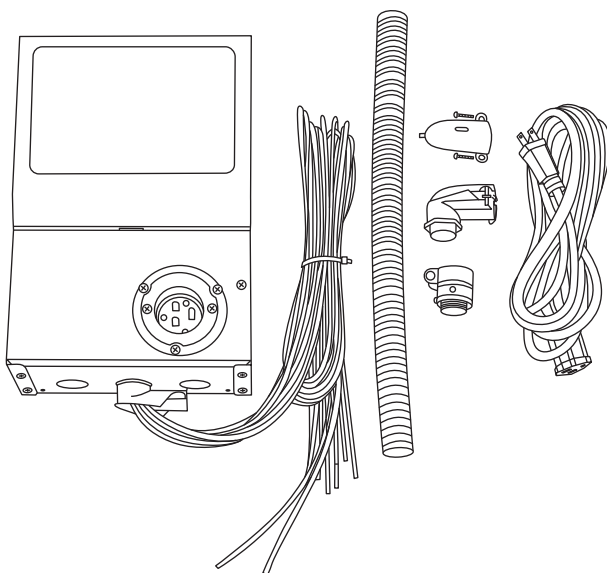

Power Transfer Kit

Contents

Welcome	1
Warning	1
Unpack Your Power Transfer Kit	2
Connect Your Power Transfer Switch to Nature's Generator	3
Use Your Power Transfer Switch	4
FAQ	5
Limited Warranty	6

Welcome

Congratulations on the purchase of your new Power Transfer Kit, a state-of-art power transfer kit that links your Nature's Generator to your existing power circuits in your breaker panel. Please read these instructions thoroughly prior to use, then store this manual in a safe place for future reference. If at any time you are unclear about this product, or require additional assistance, please do not hesitate to contact our Customer Support line at 805-383-0003 or email us at support@naturesgenerator.com.

Power Transfer Kit is made by Reliance Controls. If you have any questions regarding the installation process, you may also contact the Customer Service Team at Reliance Controls. They are available for assistance at 1-800-634-6155.

Warning

THE POWER TRANSFER KIT MUST BE INSTALLED BY A QUALIFIED ELECTRICIAN IN COMPLIANCE WITH ALL APPLICABLE ELECTRICAL CODES!

The installation procedure can be found on the other manual in the envelop in the box.

Unpack your Power Transfer kit

1. Power Transfer Switch

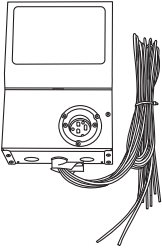

2. Conduit



3. Cable Clamps



4. 12-foot-long Power Cord:



5. The Installation Manual from Reliance Controls and this User Manual

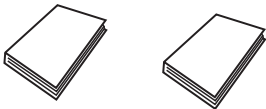

Visit NaturesGenerator.com for More Information

Connect Your Power Transfer Switch to Nature's Generator

Once the Power Transfer Switch has been successfully installed by a qualified electrician, you can now connect your Power Transfer Switch to your Nature's Generator by using the included power cord.

You can connect up to four circuits from your breakers into your Power Transfer Switch. You may select the most common used circuits like refrigerators, lights in hallway or bathroom, bedroom outlets and etc. The run time are affected by the combined loading on the connected circuits and the amount of the Nature's Power Pods that are connected to Nature's Generator.

1. Fit the female connector of the included power cord into the power inlet of your Power Transfer Switch.
2. Insert the male plug into any of the AC outlets on the Nature's Generator.

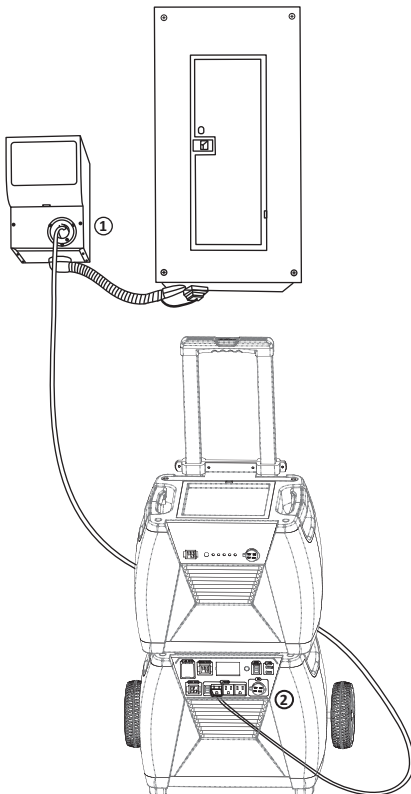

Visit NaturesGenerator.com for More Information

Use Your Power Transfer Switch

Once you've connected the Power Transfer Switch to the Nature's Generator you are now ready to continue powering your most needed items at home during loss of power.

When you experience power loss simply follow these steps to continue powering your items:

1. Turn the Nature's Generator Main Power Switch to ON (The LCD screen will turn on).
2. Turn the Nature's Generator AC Switch to ON (The light above the AC outlets will turn green).
3. Select the toggle switches of the circuits that you want your Nature's Generator to power and move their position from LINE to GEN.
4. You are now ready to go!

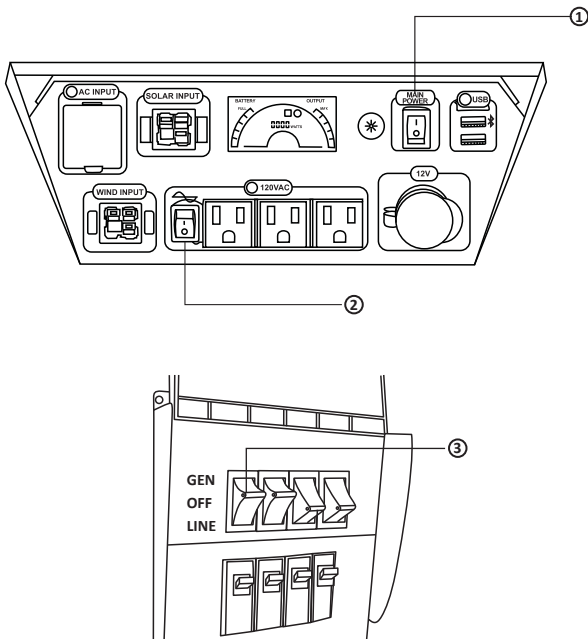

When your power is restored:

1. Move the position of the toggle switches from GEN to LINE.
2. Turn the Nature's Generator AC Switch to OFF (The green light above the AC outlets will turn off)
3. Turn the Nature's Generator Main Power Switch to OFF (The LCD screen will turn off)

Visit NaturesGenerator.com for More Information

FAQ

Where shall I install the Power Transfer Kit?

The size of Power Transfer Switch is 13 1/4 x 8 x 4 3/4 inches. The conduit is approximately 18 inch long with the clamps. It is recommended to install it in a close area to your breaker panel.

Can I use Power Transfer Kit and Nature's Generator to back up 220V?

Unfortunately, it only works on 110V. It is not compatible with 220V.

What happens when the utility power is restored?

When your utility power is restored, other lights and appliances on the circuits that are not connected to Power Transfer Switch will turn on. To transfer the circuits on the generator to utility power, flip the toggle switches back to the LINE position and shut down your Nature's Generator.

Will the surge damage my Nature's Generator when the utility power is restored?

No. The circuits that are connected to Power Transfer Switch are isolated from the utility power. There is no danger of back feeding the utility power.

What will I be able to power?

Runtimes with the Power Transfer Kit are dependent on the combined loading of connected circuits and the amount of the Nature's Power Pods that are connected to Nature's Generator. For instance, a 70W LED light will run about 10 hours with only the Nature's Generator. That same 70W LED light will run about 27 hours with the Nature's Generator and one Nature's Power Pod. And that same 70W LED light will run about 44 hours with the Nature's Generator and two Nature's Power Pods

Can I use it off the grid like in cabin or RV?

Yes. If it is always powered by your Nature's Generator, please keep the toggle switch on your Power Transfer Switch to GEN position.

Can Power Transfer Kit recharge my Nature's Generator?

No. Power Transfer Kit cannot recharge your Nature's Generator. Your Nature's Generator has to be recharged through standard AC outlet or Nature's Power Panel or Nature's Wind Turbine.

Can Power Transfer Kit work with other Generators?

Yes. It works with other battery powered generators or gasoline powered generators.

Limited Warranty

Please refer to the other manual about warranty information.

