

1. Important Safeguards

1. READ ALL INSTRUCTIONS BEFORE USING

DANGER - To reduce the risk of electric shock:

1. Do not place or store this appliance in a location where it can fall or be pulled into a tub or sink.
2. Do not place in, or drop into water or other liquids.
3. Do not touch a product that has fallen into water. Unplug immediately.

WARNING - To reduce the risk of burns, electric shock, fire or injury.

1. Close supervision is necessary when this appliance is used by or is near infants, elders, or handicapped persons. Children should not be permitted to use or touch this appliance without adult supervision. Be sure to adjust the toilet seat's temperature for elders, handicapped persons, or people with sensitive skin.
2. Use this appliance only for its intended purpose as described in this manual. Do not use attachments not recommended by the manufacturer.
3. Do not operate this appliance if the cord is damaged or if the product is dropped into water.
4. Install the unit properly by following the installation procedure.
5. Only authorized persons can install or repair the unit. Do not attempt to service this appliance by yourself. Doing so could void the warranty.
6. Keep the cord away from heated surfaces.
7. Never drop or insert any objects into any opening or hose.
8. Do not use outdoors. Do not use aerosol or oxygen spray products on the unit.
9. Always follow the grounding instructions in this manual before plugging in the unit.

SAVE THESE INSTRUCTIONS

2. Cautions before installation

1. NOTE THE FOLLOWING IMPORTANT POINTS

1. Do not install in a location where water might be splashed on this appliance or in a location exposed to excessive moisture where condensation might form on the product's surface.
2. To avoid damage to electronic components due to high levels of humidity, provide adequate ventilation by opening a window and/or door when bathing.
3. Water supply should have a water pressure of 11.38 psi to 106.68 psi.
4. Connect the product to a pipe carrying potable water. Do not connect to an industrial water line or other water supplies that are not potable.
5. Cool the unit in the room before installation.
6. The thermal protector in the water tank may malfunction when transporting or storing warm water.
7. The rated power voltage is 120V AC, 60Hz.
8. Do not plug the unit in until installation is complete. It may result in malfunction.

2. Cautions before installation

2. WIRING REQUIREMENTS

1. Any other servicing should be performed by authorized service representatives.

2. GROUNDING INSTRUCTIONS

This product should be grounded. In the event of an electrical short circuit, grounding reduces the risk of electric shock by providing an escape wire for the electric current. This product is equipped with a cord having a grounding wire with a grounding plug. The plug must be plugged into an outlet that is properly installed and grounded.

DANGER-Improper use of the grounding plug can result in a risk of electric shock.

Do not connect the grounding wire to a flat blade terminal. The grounding wire can be identified by its insulated outer surface. It will either be colored green or will not contain yellow stripes.

Check with a qualified electrician or serviceman if you do not understand grounding instructions or if you do not know whether the product is properly grounded.

3. This product is for use on a nominal 120V circuit. It has a grounding plug that looks like the plug illustrated in sketch A. A temporary adapter, which looks like the adapter illustrated in sketches B and C, may be used to connect this plug to a 2-pole receptacle as shown in sketch B if a properly grounded outlet is no available. The temporary adapter should be used only until the properly grounded outlet (sketch A) can be installed by a qualified electrician. The green colored rigid ear, lug and the like extending from the adapter must be connected to a permanent ground such as a properly grounded outlet box cover. Whenever the adapter is used, it must be held in place by the screw.

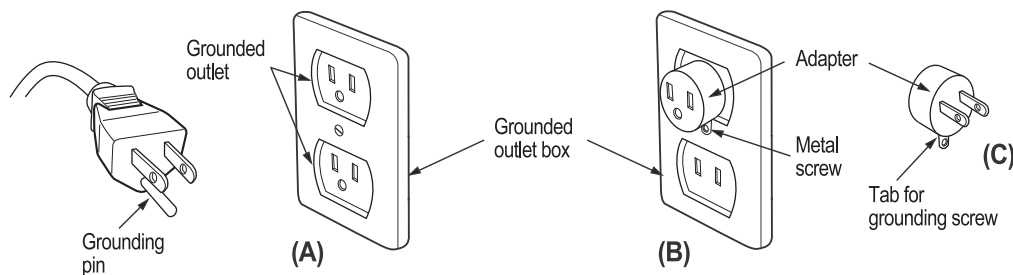

4. If it is necessary to use an extension cord, use only a three prong wire extension cord that has a three-blade grounding plug, and a three-slot receptacle that will accept the plug on the product. Replace or repair a damaged cord.

CAUTION
RISK OF EXPLOSION TO BATTERY IF REPLACED BY AN INCORRECT TYPE.
DISPOSE OF USED BATTERIES ACCORDING TO THE INSTRUCTIONS.

3. Identification

Main unit

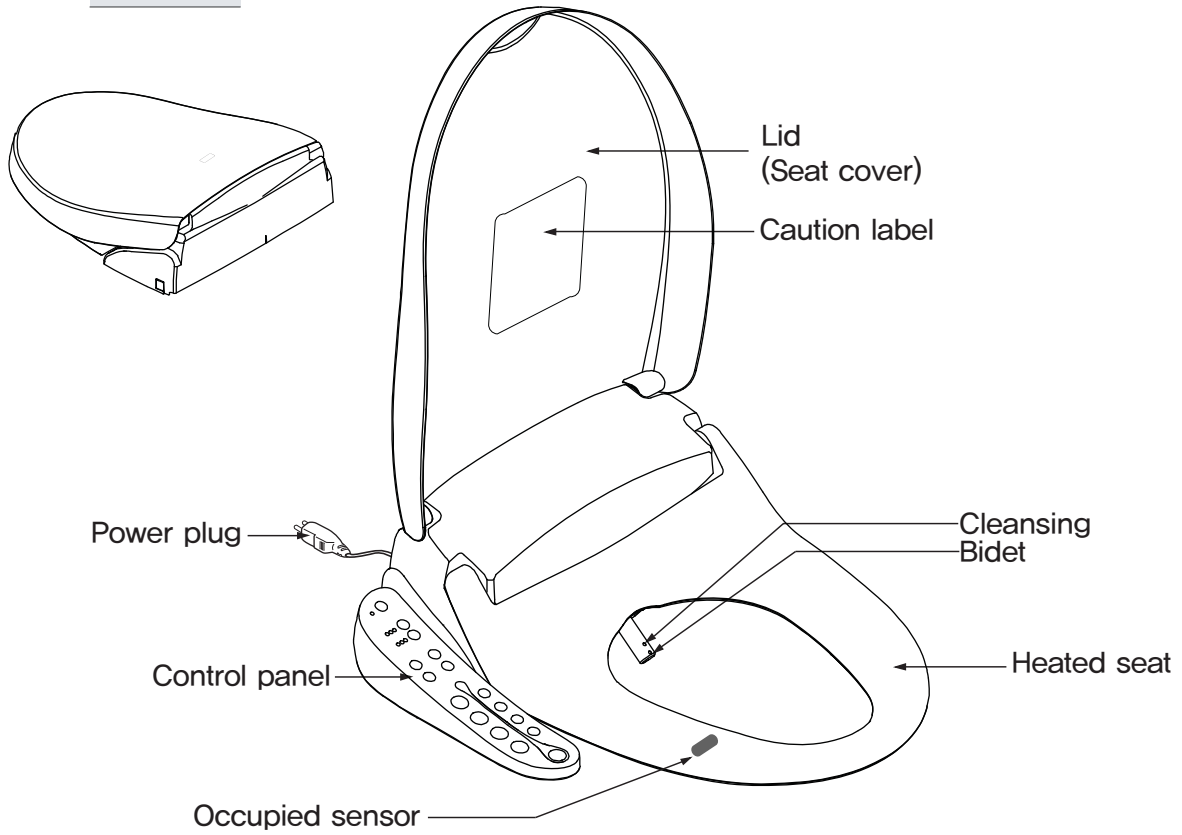

Accessories

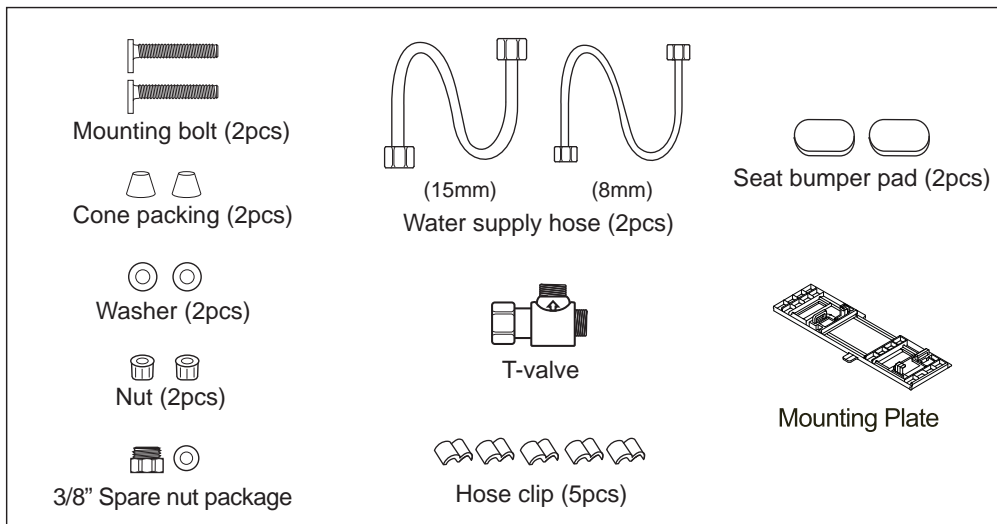









※ In the interest of continued product improvement, specifications may change without notice.











4. Safety Information (Danger)

Follow basic instructions to ensure the safe use of your appliance.

DANGER

Failure to follow may cause severe injury or death. Follow the instructions.

 Indicates a [prohibited] use of the appliance.	 Prohibited  Do not disassemble  Use of fire prohibited  Do not handle with wet hands
 Indicates a [required] step in use of this appliance.	 Required step  Ground Connection

-  Do not splash water or cleansers on the product's plug. Doing so may result in fire or electric shock.
-  Do not plug or unplug with wet hands.
 -It may result in injury or electric shock.
 -Regularly wipe off the plug and electric outlet with a dry, soft cloth to prevent electric shock or fire.
-  Do not use a faulty or loose electric outlet or cord.
 -Doing so may result in short circuit, electric shock or fire.
-  Do not throw anything flammable into the toilet.
 -Doing so may result in fire, discoloration or malfunction.
-  Grounded wire or outlet must be installed.
 -Not doing so may result in malfunction or electric shock.
 -If no grounded plug is used, make sure to install grounded wire.
-  Do not use many appliances in one power strip.
 -Doing so may result in fire or damage.
 -Be sure to use a dry and clean outlet.
 -Do not use a faulty or loose outlet.
-  Use potable water only. (ground water)
 -Not doing so may cause irritation or injury to your skin.
 -It may clog the pipe due to contaminants.
-  Do not disassemble the seat.
 -Doing so may result in electric shock.
-  Do not disassemble, repair or modify this appliance.
 -Doing so may result in electric shock, injury or malfunction.
-  Unplug when you hear beeping or smell strange odor.
 -Unplug right away and contact your dealer from whom you bought this appliance.













5. Safety Information (Warning)

Follow basic instructions to ensure the safe use of your appliance.

WARNING

Might cause slight injury or damage. Be aware.

 Indicates a [prohibited] use of the appliance.	 Prohibited	 Do not disassemble	 Use of fire prohibited	 Do not handle with wet hands
 Indicates a [required] step in use of this appliance.	 Required step	 Ground Connection		

-  Be aware of a low-grade burn.
 - It may result in a low-grade burn if sitting on the heated seat for a long time.
 - Be aware if being used by the following:
children, senior citizens, patients, people who cannot control the temperature, people who are not sober, or people who are tired.
 - If injured in a low-grade burn, see a doctor immediately.
-  Do not step on or place heavy objects on this appliance.
 - Doing so may damage the unit.
 - Do not step on a lid, seat, or control panel to avoid injury or product damage.
-  Unplug while not using over extended period of time.
-  Unplug when there is thunder or lightening.
-  Use this appliance on a toilet only.
 - Not doing so may result in fire, injury or electric shock.
-  Do not use force to pull out the water hose.
 - Doing so may cause water leakage.
-  Be aware of urine splash on a nozzle or warm air dryer outlet.
 - Not doing so may result in malodor or failure.
-  Do not use force to close the lid.
 - Doing so may cause malfunction.
 - Be aware not to put fingers between the lid and seat when you close the toilet. It may cause injury.
-  Unplug when cleaning.
 - Not doing so may result in fire or electric shock.
-  Use low temperature for children and handicapped.
 - If the temperature is too high, it may result in burn if they fail to recognize the temperature.
-  Do not sit or lean against the lid or the control panel.
 - Doing so may cause malfunction or breakage.
 - Applying excessive force may damage the lid or components that may lead to injury.
-  Do not put a vase cup or small materials on this appliance.
 - Doing so may result in fire or electric shock.

6. How to install

※ **If electric work is needed, please contact a qualified electrician or serviceman only.**

Remove the existing toilet lid and seat

1. Remove the nuts, washers, and cone packings from the toilet seat and mounting bolts in the back of the toilet.
2. Remove the toilet seat, lid and mounting bolts.
3. Keep them in case you need them.

Balance Pads

Depending on your toilet model, the toilet bowl may not be even and there could be a small gap on the front side of the bidet seat and the toilet bowl. Two (2) white adhesive pads supplied with your installation kit to be used to balance seat. Affix adhesive pad to seat bumper located on the underside of the bidet seat to balance the seat with toilet bowl.

Install the appliance

Installation

■ How to mount the plate

- 1 Place the mounting plate over each mounting hole. Insert the mounting bolts through the plate and mounting holes. Slide cone packings and washers onto the bolts and fasten tightly with nuts.

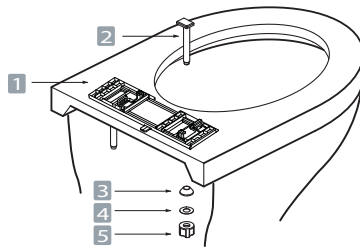

- | | | |
|------------------|-----------------|-------|
| 1 Mounting plate | 2 Mounting bolt | |
| 3 Cone packing | 4 Washer | 5 Nut |

Toilet size (Elongated & Round front)

- 1 The toilet dimensions must be within those shown below. Do not install this appliance on a toilet that does not meet these dimensional requirements.

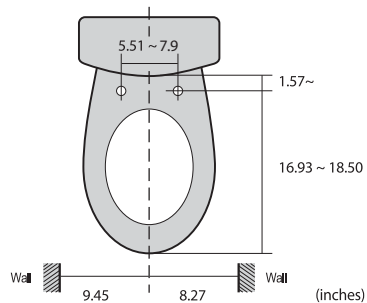

■ How to attach and detach the unit

- 1 While pressing the detach button, slide the unit until it clicks into the plate.

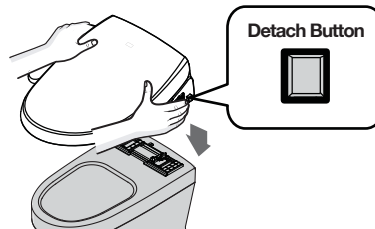

- 2 While pressing the detach button, pull the unit forward and separate it from the toilet bowl.

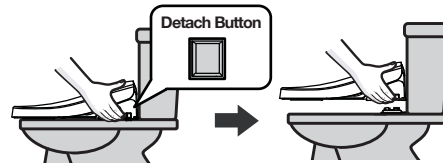

Occupied sensor

- 1 This appliance is equipped with an occupied sensor.
- 2 The unit will not work unless the seat is occupied.

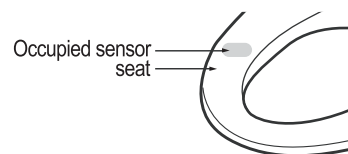

Connecting the water hose

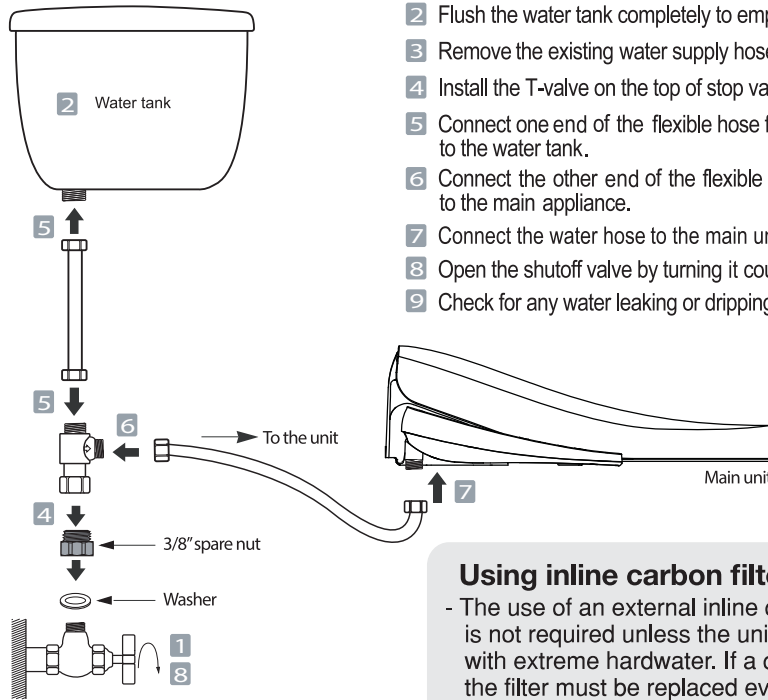

- 1 Close the shutoff valve by turning it clockwise.
- 2 Flush the water tank completely to empty.
- 3 Remove the existing water supply hose from the tank.
- 4 Install the T-valve on the top of stop valve.
- 5 Connect one end of the flexible hose from the T-valve to the water tank.
- 6 Connect the other end of the flexible hose from the T-valve to the main appliance.
- 7 Connect the water hose to the main unit.
- 8 Open the shutoff valve by turning it counter clockwise.
- 9 Check for any water leaking or dripping.

Using inline carbon filter

- The use of an external inline carbon water filter is not required unless the unit is used in an area with extreme hardwater. If a carbon filter is used, the filter must be replaced every 6 months. Inline carbon filters can be purchased from any authorized Bio Bidet reseller.

※ Shutoff valve sizes may vary. If supplied parts do not fit, please call 847-458-2334.

Trial operation

1. Preparation

Plug the power cord into the outlet, and then the water tank will be filled with water in 2 minutes.

2. Checking all functions

Cover the toilet bowl using the sheet of plastic wrap on the unit to prevent the washing water from being sprayed out of the toilet.

Then check for all function described in this manual.

3. There are possibilities of water coming out that remains in the unit while heating.

10. Before calling for service

Problem	Possible cause	Solution
Completely fails to work	Is there a power cord outage? Is the power cord unplugged? Are you sitting on the seat correctly?	- Check for power cord failure or a tripped breaker - Plug the power cord in properly - Sit on the seat completely
Water does not spray	Is the water shutoff valve closed? Is the strainer clogged? Are the nozzles clogged? Is the water purifying filter clogged?	- Check for any water leaking or dripping - Clean the strainer - Clean the nozzles - Change the water purifying filter
Water is leaking or dripping	Are all hoses tightened up properly?	- If water is still leaking or dripping, contact to your dealer
Seat, water or air is not warm enough	Is the temperature set to OFF? Is appliance used in economy mode during cold weather?	- Reset the temperature - Release the economy function

11. Specifications

Item	Everclean A7	
Standard power supply	AC 120V 60Hz 1248W	
Water supply	Way of connection	Direct connection to tap water
	Water pressure	0.07MPa ~ 0.74MPa
Clean-sing	Spray for cleansing	700 (±150)mℓ/min
	Spray for bidet	700 (±150)mℓ/min
	Water capacity	740mℓ
	Spray temperature	Room temp ~ 39°C(102.2°F)
	Heater capacity	1200W
	Safety feature	Thermal switch, Temperature fuse, Floating switch
Heated seat	Seat temperature	Room temp ~ 39°C(102.2°F)
	Heater capacity	48W
	Safety feature	Temperature fuse
Deodorization method	-	
Circuit breaker	Within 15mA 0.03 second	
Length of power cord	1.5m	
Dimensions	(W)481 mm(18.94 inches) X (L)528 mm(20.79 inches) X (H)160 mm(6.30 inches)	
Weight	4.6Kg(10.14lbs)	

※ Recommended water supply pressure are 0.07MPa~0.74MPa

※ The minimum available water supply pressure is 0.07MPa, however under 0.1MPa pressure, water spray pressure might not be enough strong.