

Barrier Free, Roll In Shower 60" x 30"

Ella Standard - Center Drain



ella
by ella's bubbles

**Flat
Wall
Option**

Model #

- 6030 BF 5P .75C-WH STD
- 6030 BF 5P .75C-BN STD
- 6030 BF 5P .75C-B STD

Ella Standard Accessories (optional)



Outside Dimensions: 31" W x 60" L x 77.75" H
 Shipping Dimensions: 48" W x 79" L x 84" H
 Shipping Weight: 437 lbs.
 Net Weight: 425 lbs.
 Threshold Height: 3/4" Change of Level 

Package Options:

- White (W), Bone (BN) or Biscuit (B) Shower Panels
- Standard, Plus 24, Plus 36, Freedom, Deluxe, or Elite (premium fixtures in white, brilliant or satin)
- With molded soap ledges - tile pattern option
- Without soap ledges - flat wall option
- Flange Trim Molding Kit
- Multi-Piece Window Trim Kit

Panels:

- Shower Base 31" W x 60" L x 4.25" H
- Side Wall Panel Left 31" W x 73.75" H
- Side Wall Panel Right..... 31" W x 73.75" H
- Rear Wall Panel Bottom 60" L x 44" H
- Rear Wall Panel Top..... 60" L x 29.75" H

Features:

- Premium marine grade gel-coat, five piece shower with 8" classic tile pattern
- Wood and steel reinforced walls for placing grab bars and seats anywhere (not dependent on stud locations)
- Easy shower wall assembly pin-lock system allowing front side installation
- Precision fit wall panel seams (match into grout pattern)
- Grip-Sure™ floor texture
- Self supporting, pre-leveled shower base (no mudset required)
- Shower door friendly (squared corners allow door installation)
- Ships pre-assembled, heavy duty crating protects product in transit

Accessories:

- 2" Chrome strainer brass drain with friction seal.
- Collapsible Dam Kit

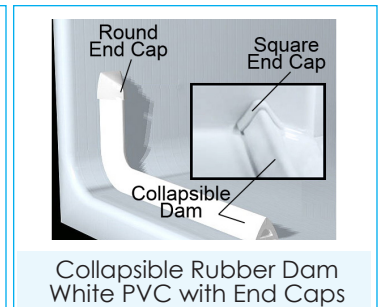

Codes:

IPC, UPC, ANSI Z 124.2, NAHB, HUD, FHA

Warranty:

30 Year Limited Lifetime Warranty (on shower panels)*

*For more information please visit www.ellasbubbles.com

 Change of Level threshold has manageable 1/4" vertical rise to easily coordinate with minimum finished flooring.

Barrier Free, Roll In Shower 60" x 30"
6030 BF 5P .75 - Center Drain

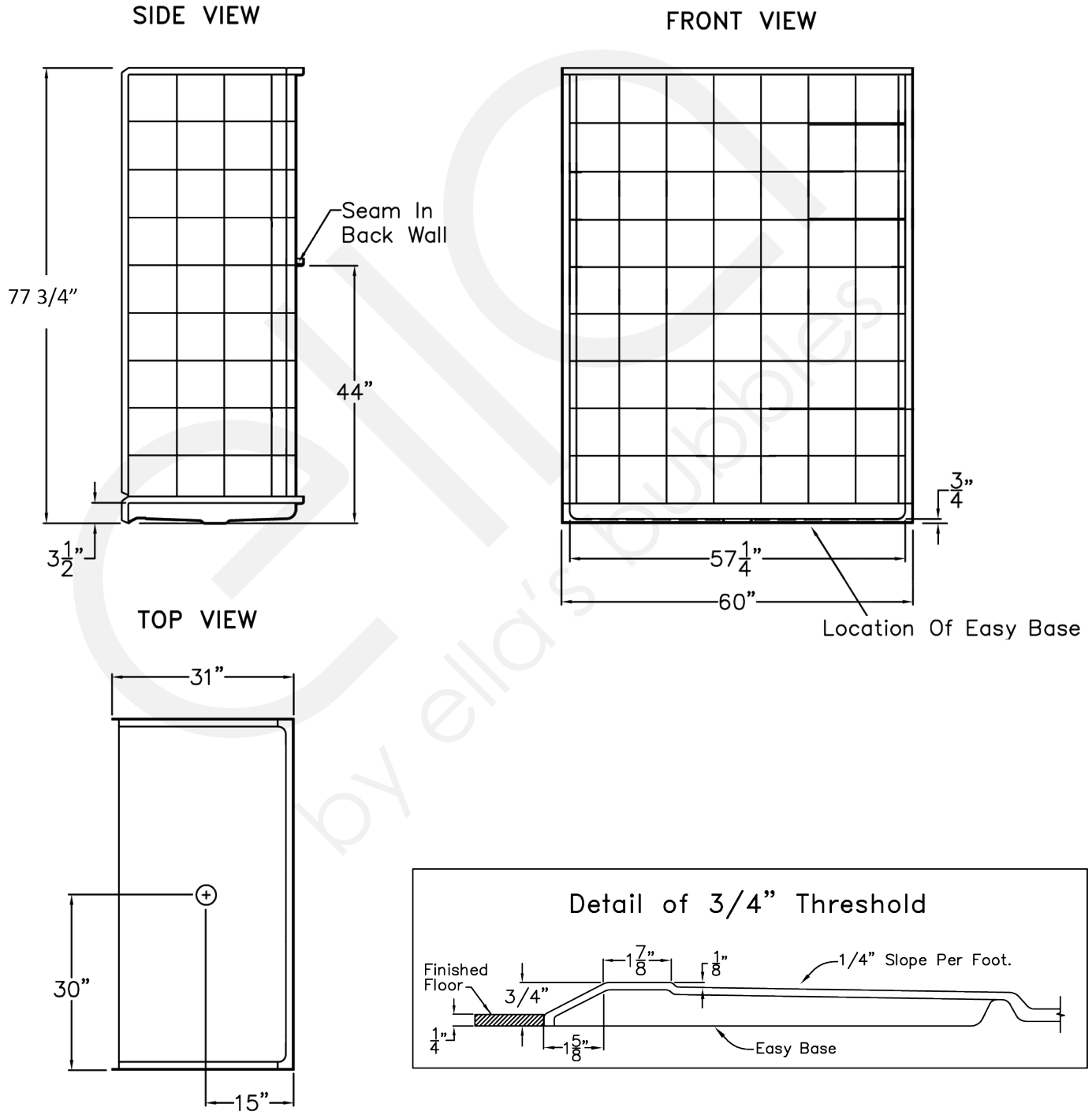

Disclaimer:

In an effort to continually improve our product, specifications and configurations are subject to change without notice. Before ordering or installing, consider future access to essential equipment. Due to the nature of the materials, dimensions may vary $\pm 1/2"$.

STRENGTH

Wood & Steel Reinforced Walls

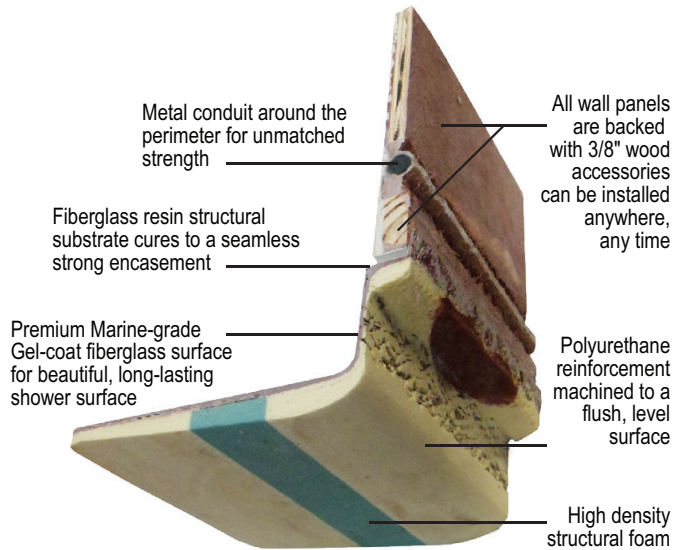

Twice the weight and twice the raw materials used in the construction of our showers than listed by any of our competitors. Wood reinforced core walls and high density base. Metal conduit around perimeter of EACH panel for added strength.

ADAPTABILITY

Customized Accessory Placement

The wood reinforced core walls allow the fixtures to be installed right onto the wall studs by eliminating the need for a drywall backing.

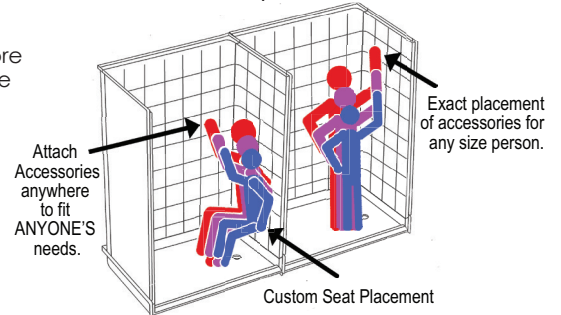

SHOWER DOOR FRIENDLY

Your choice: Curtain or Door

Square corners in Ella shower construction allow for framed or frameless shower doors to be installed.

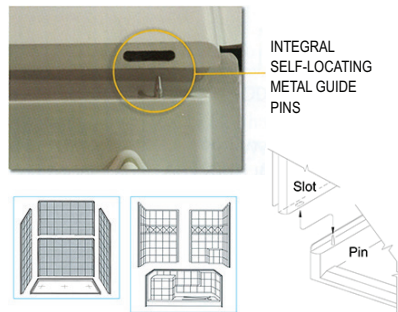

Image for illustration only

FRONT SIDE INSTALLATION

Aluminum Pin and Slot System for a contractor friendly front side installation.

An installation may be finished in a fraction of the time. No more need to get behind the panels to bolt large panels together.



AVAILABILITY

Your Project won't be held up

Ella showers are manufactured, inspected and shipped directly from the factory within 5 - 7 business days.

Rush orders are available upon request (white only).

No order is too big or small.

SMART PACKING

Multi-piece Shower in a Box



In stock for Rapid Ship

PRE-LEVELLED BASE

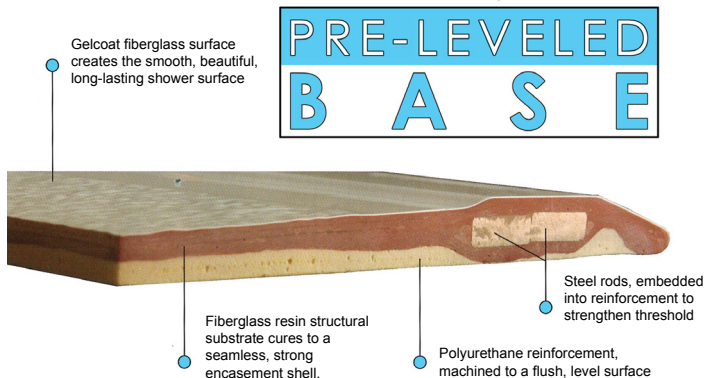

Barrier Free 1"

