

Assembly Instructions

Caution : You must read this before you proceed







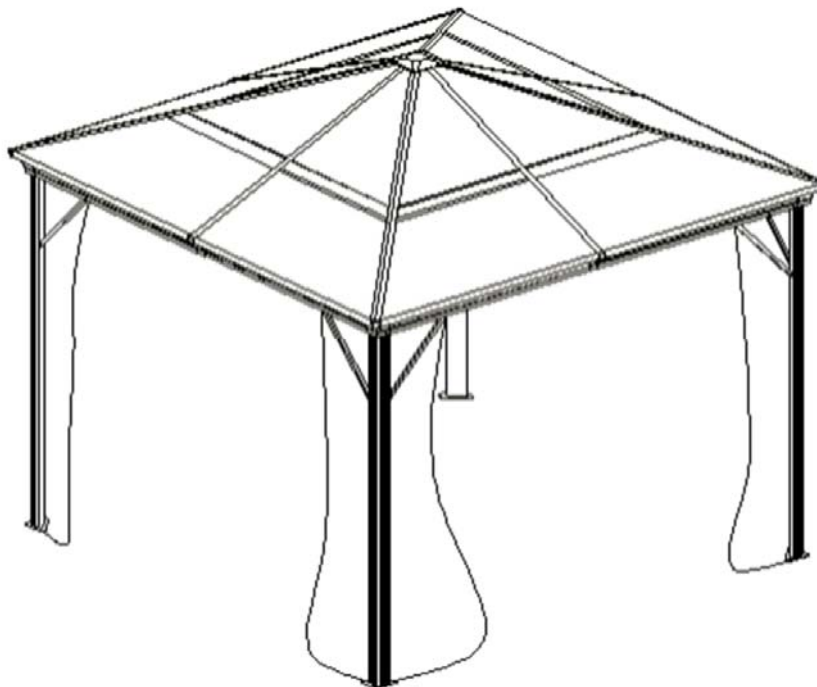



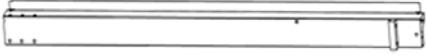

Read all instructions before assembling and using this product







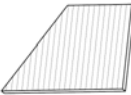
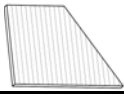

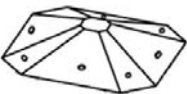

1. Select ideal location. Set out all parts on a clear and level surface prior to assembly. Ideally, the Gazebo should be set up in the desired location to avoid moving it after assembly.
2. Team Work. We recommend 4-5 adults and it may require 3 to 4 hours to fully assemble the Gazebo. If possible, please use safety ladders.
3. Use caution. During the entire assembly process, especially when lifting heavy or large parts or using ladders, pay attention to safety. No one other than the adult assistants should be allowed in the work area.
4. Check all available parts. Before assembling your Gazebo Frame, make sure that you have all the parts described in the Parts List.
5. Ensure that ALL BOLTS are fully and securely tightened before you proceed to attach the Canopies.
6. Keep children away. Children shouldn't be allowed in the work area. Do not let them handle parts and tools. Do not allow children to climb the Gazebo.

Gazebo











Parts List

Label	Picture	Description	QTY
A		Column	4
B		Left Short Beam	4
C		Right Short Beam	4
D		Long Corner Roof Bar	4
E		Short Roof Bar	4
F		Left Roof Finishing Bar	4
G		Right Roof Finishing Bar	4
H		Connection Piece	12
I		Left Roof Support Bar	4
J		Right Roof Support Bar	4
K		Left Roof Panel (Upside)	4
L		Right Roof Panel (Upside)	4
M		Left Roof Panel (Downside)	4
N		Right Roof Panel (Downside)	4
O		Bar Union	4
P		Corner Cover	4

Q		Joint Cover Plate	4
R		Outside Roof Connector	1
S		Inside Roof Connector	1
T		Base	4
U		Track	8
V		Mosquito Netting	4
W		Curtain	4
X		Finishing End	4
Y		Corner Finishing End	4
Z		Hook	112

Hardware

Label	Picture	Description	QTY
①		Screw (ST5*10mm)	33
②		Bolt (M5*10mm)	13
③		Bolt (M6*12mm)	9
④		Bolt (M6*15mm)	136
⑤		Bolt (M6*30mm)	17
⑥		Screwdriver	1
⑦		Allen Key	1
⑧		Stake	12
⑨		Washer	163

Assembly Preparation

Before Beginning Assembly:

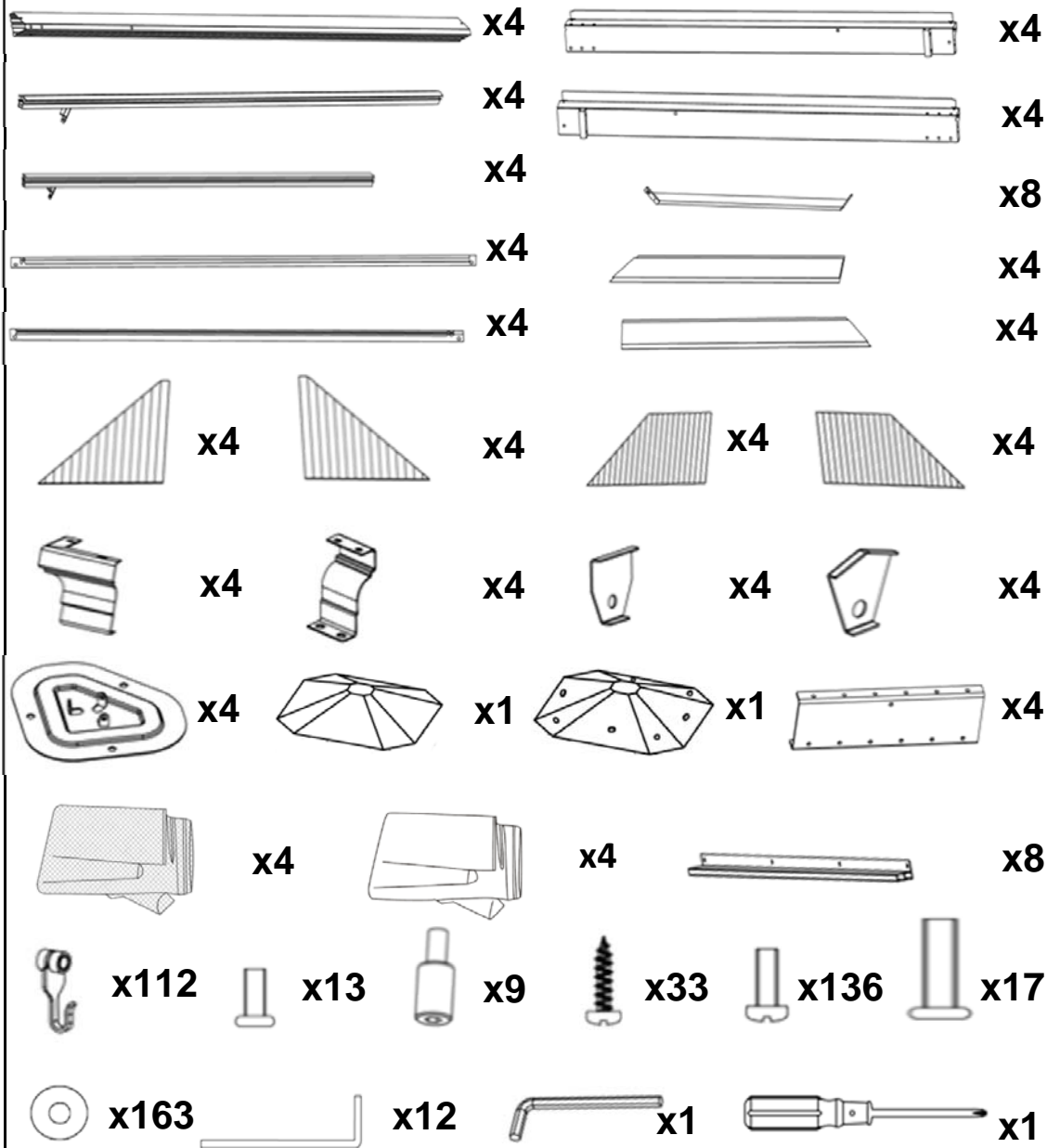

- Read instructions, cover to cover-



- Have 4-5 adults on hand for assembly-



- Do not assemble on flooring or carpet-



- Assemble on a clean non-marring surface (packing foam)-



- Save all packaging until finished-

Assembly Steps

Overview

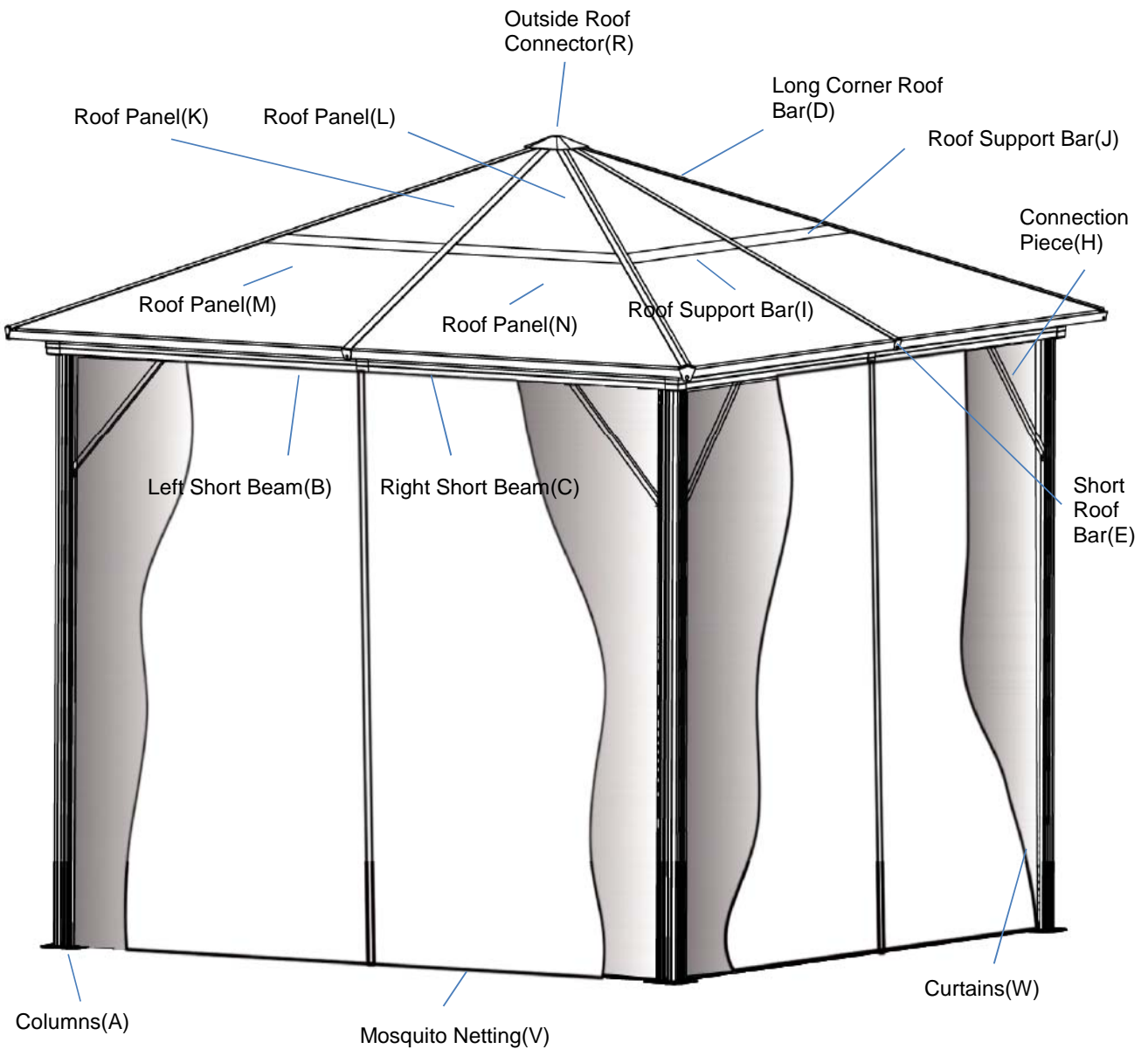

This Gazebo has multiple parts and may require up to 3 hours to assemble. To give you an overview of the Gazebo parts, the above picture is to help you put the various parts into perspective. Please read through the instructions below to familiarise yourself with the parts and steps before assembly.

Step 1

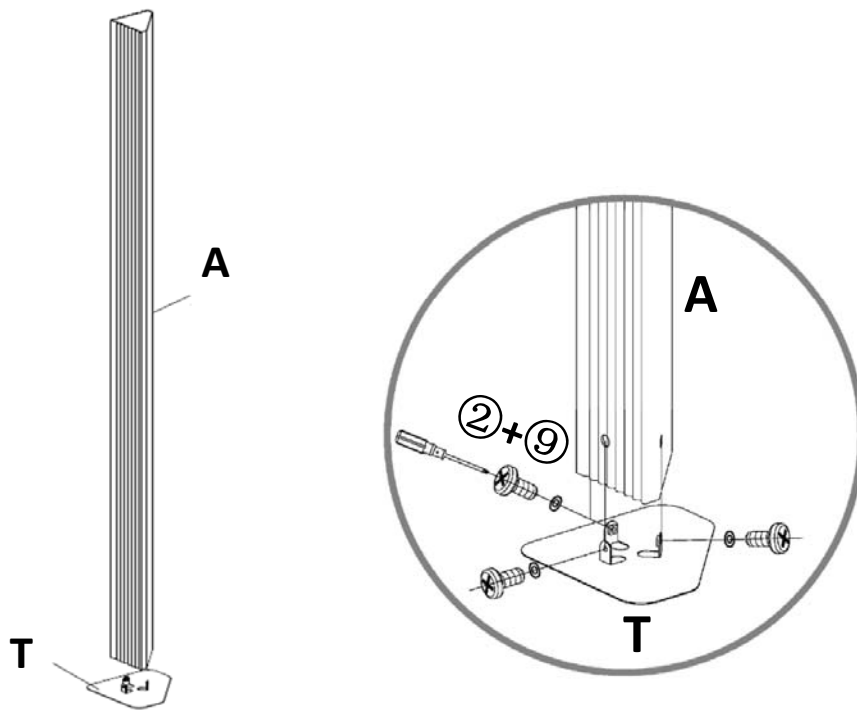

Attach Columns(A) onto Bases(T) using Bolts(②) and Washers(⑨) with Screwdriver(⑥).
Tighten the Bolts fully in a sequential manner.

Step 2

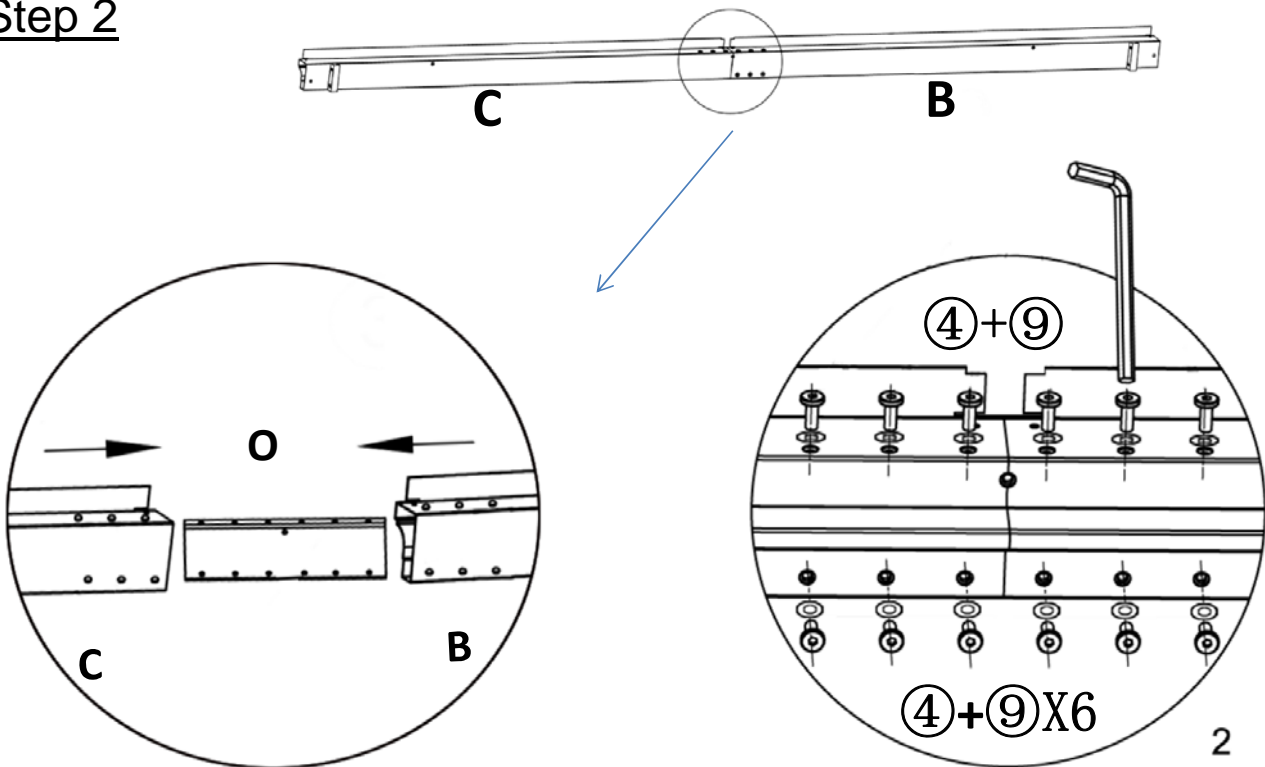

Attach Bar Union(O) between Left Short Beam(B) and Right Short Beam(C) using Bolts(④) and Washers(⑨) with Allen Key(⑦).

Note: Ensure the mounting positions of Bar Union(O) match the Left Short Beam(B) and Right Short Beam(C) mounting positions before assembling Bolts.

Step 3

3.1

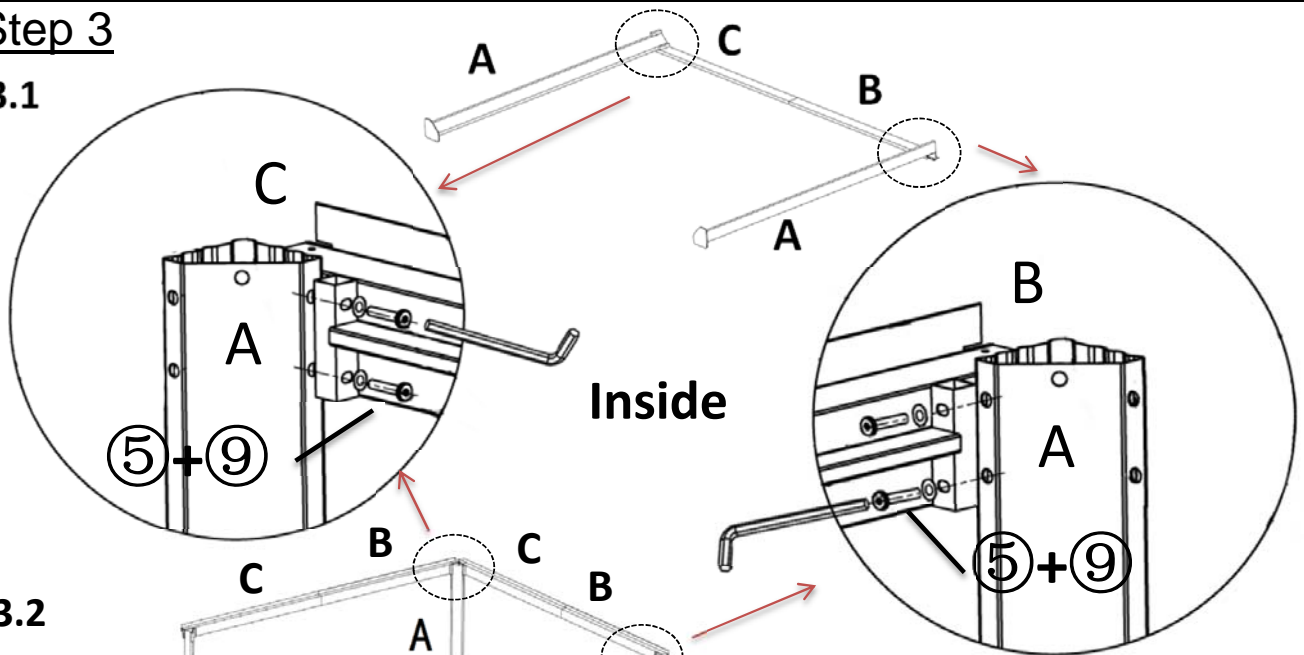

3.2

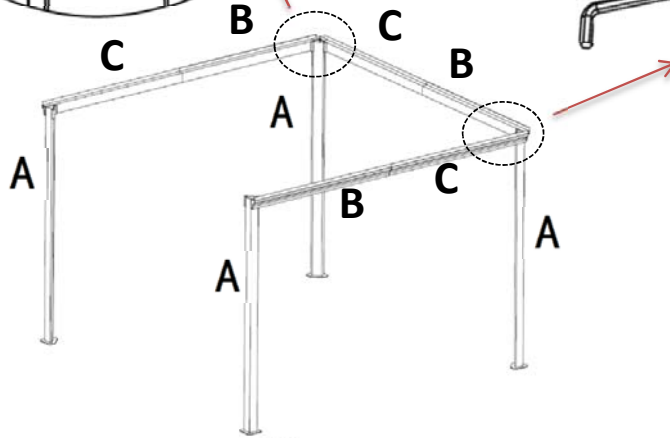

3.3

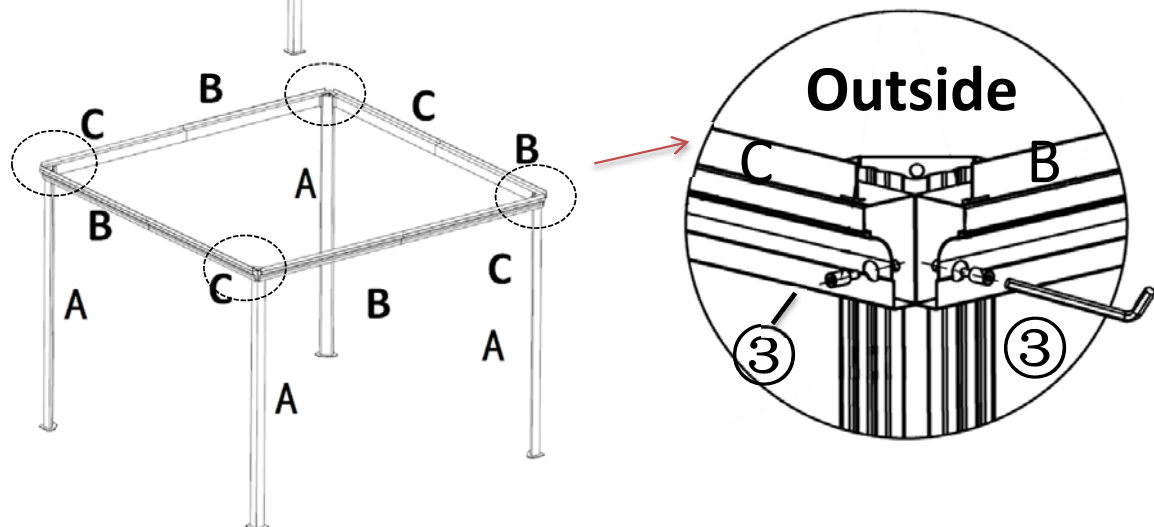

Note: Please place a blanket or carton on the floor before assembly to protect surfaces from cuts and abrasions.

3.1) Attach column inside: Left Short Beam(B), Right Short Beam(C) and Columns(A) using Bolts(5) and Washers(9) with Allen Key(7). **Repeat once and then set aside.**

3.2) Attach the two items from the previous step to another Left Short Beam(B), and Right Short Beam(C) using Bolts(5) and Washers(9) with Allen Key(7).

Repeat again with the remaining side.

3.3) Attach outside: Left Short Beam(B) and Right Short Beam(C) to Column(A) through welded bracket on Beams using Bolts(3) with Allen Key(7).

Note: Please use a ladder, if you can't reach it.

Repeat this process with the remaining Left Short Beams, Right Short Beams and Columns.

Tighten the Bolts fully in a sequential manner.

Step 4

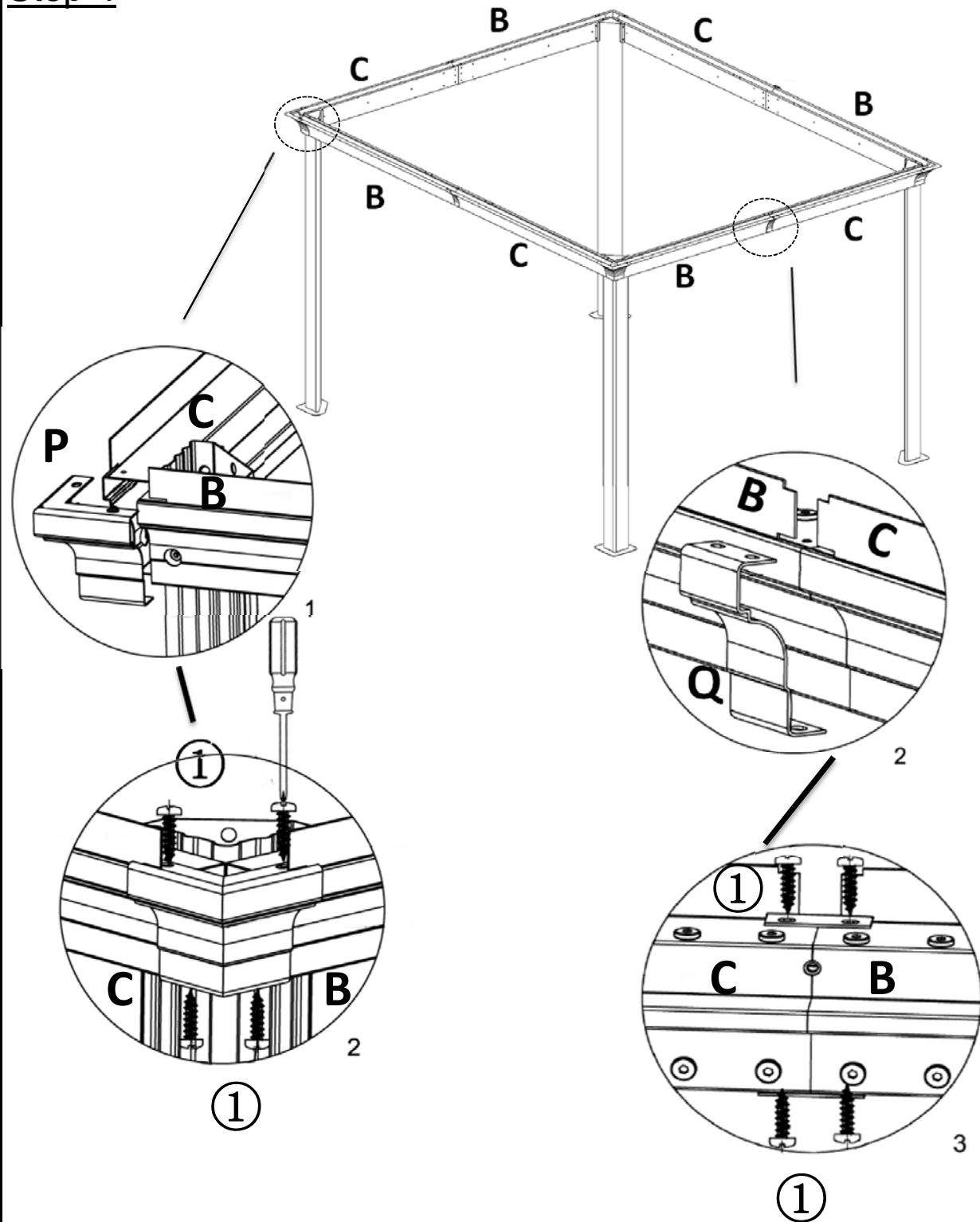

4.1) Attach Corner Covers(P) to Left Short Beams(B) and Right Short Beams(C) using Screws(1) with Screwdriver(6).

4.2) Attach Joint Covers(Q) **on the outside of** Left Short Beams(B) and Right Short Beams(C) using Screws(1) with Screwdriver(6).

Tighten the Screws fully in a sequential manner.

Note: Please use a ladder, if you can't reach it.

Step 5

5.1

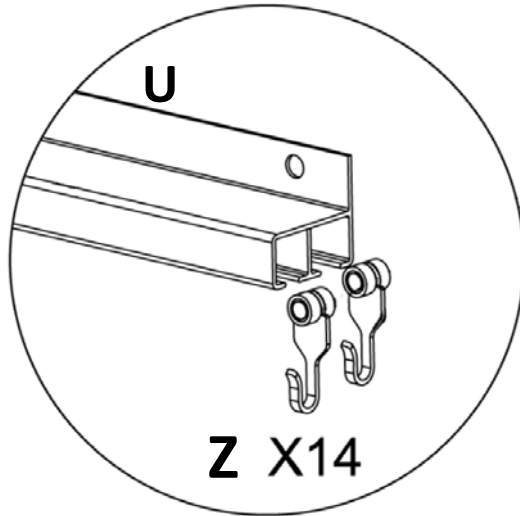

5.2

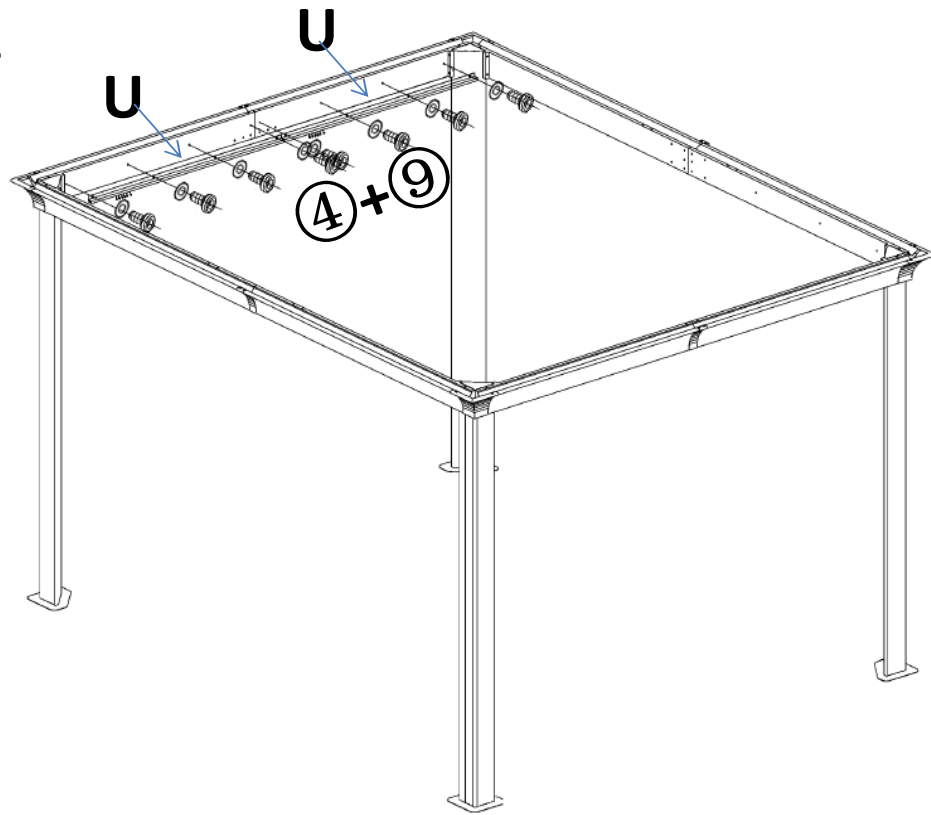

5.1) Slide seven Hooks(Z) into each Track(U).

Note: There are a total of 14 Hooks in each Track(U)

5.2) Attach Tracks(U) to the inside of Left Short Beams(B) and Right Short Beams(C) using Bolts(4) and Washers(9) with Allen Key(7).

Repeat this process with the remaining Tracks.

Tighten the Bolts fully in a sequential manner.

Step 6

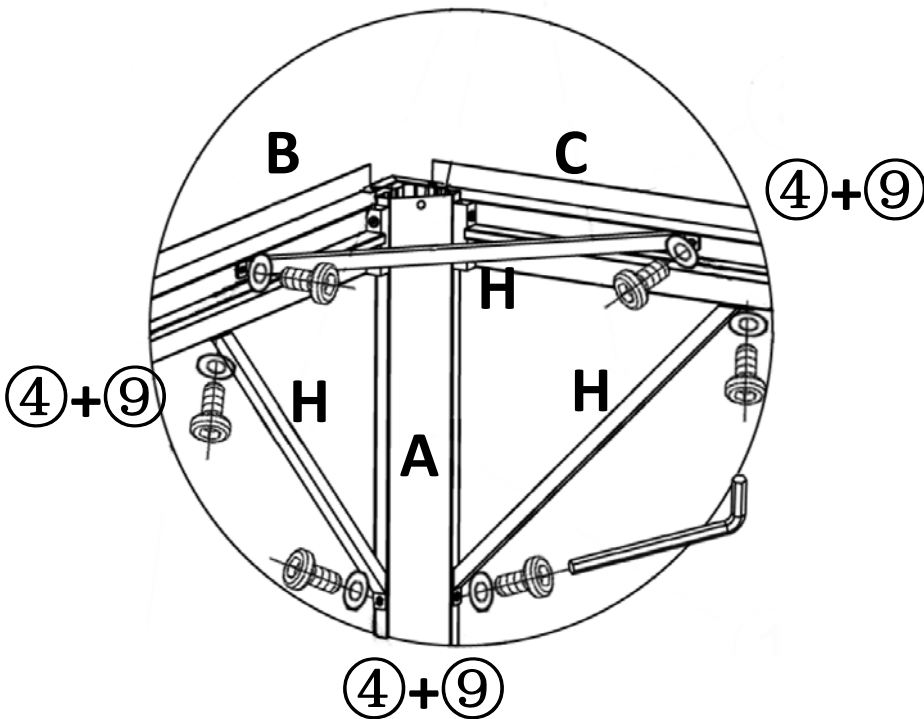
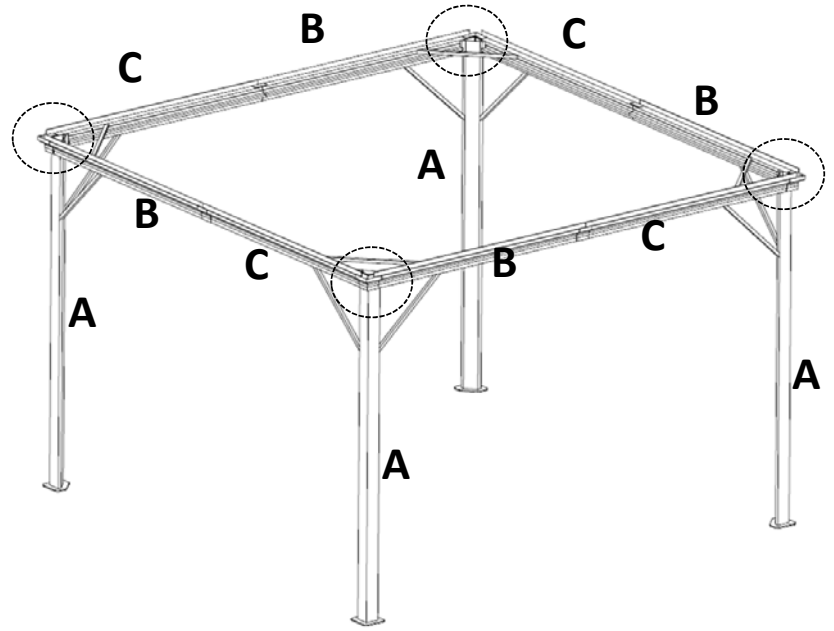

Attach Connection Piece(H) between Left Short Beam(B) and Right Short Beam(C) using Bolts(④) and Washers(⑨) with Allen Key(⑦).

Attach Connection Piece(H) between Left Short Beam(B) and Column(A) using Bolts(④) and Washers(⑨) with Allen Key(⑦).

Attach Connection Piece(H) between Right Short Beam(C) and Column(A) using Bolts(④) and Washers(⑨) with Allen Key(⑦).

Tighten the Bolts fully in a sequential manner.

Repeat this entire process with each Column.

Step 7

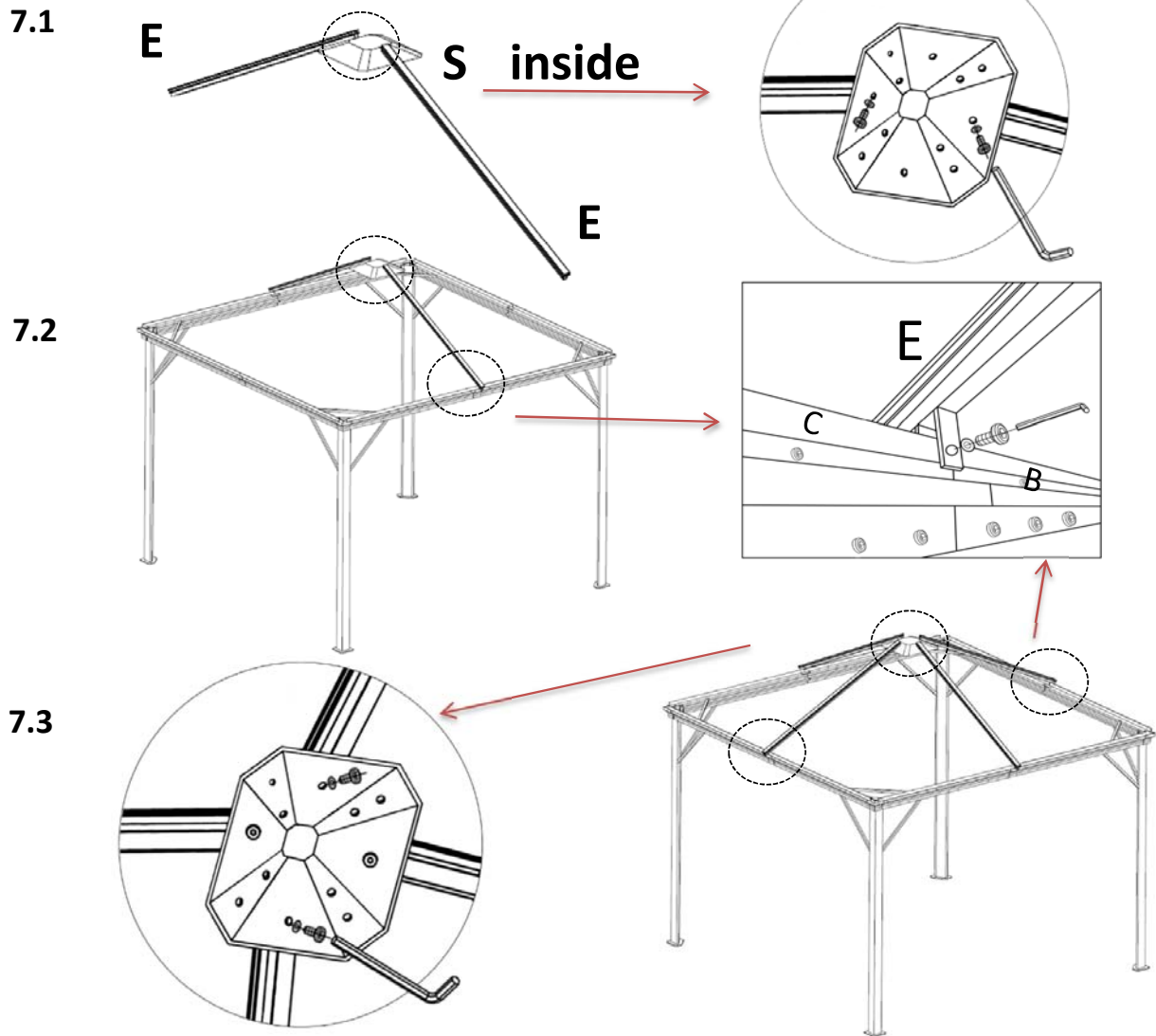
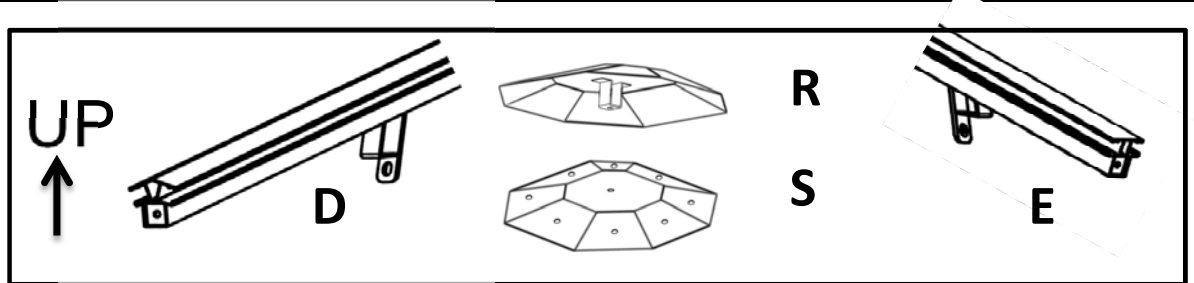

7.1) Attach two Short Roof Bars(E) one at a time to the inside Roof Connector(S) using Bolts(④) and Washers(⑨) with Allen Key(⑦) as picture above.

7.2) Attach the same Short Roof Bars(E) to the middle of the Left Short Beams(B) and Right Short Beams(C) using Bolts(④) and Washers(⑨) with Allen Key(⑦) as picture above.

7.3) Finally, attach the remaining Short Roof Bars(E) to the inside Roof Connector(S) using Bolts(④) and Washers(⑨) with Allen Key(⑦).

And attach the Short Roof Bars(E) to the middle of the Left Short Beams(B) and Right Short Beams(C) using Bolts(④) and Washers(⑨) with Allen Key(⑦).

Step 8

8.1

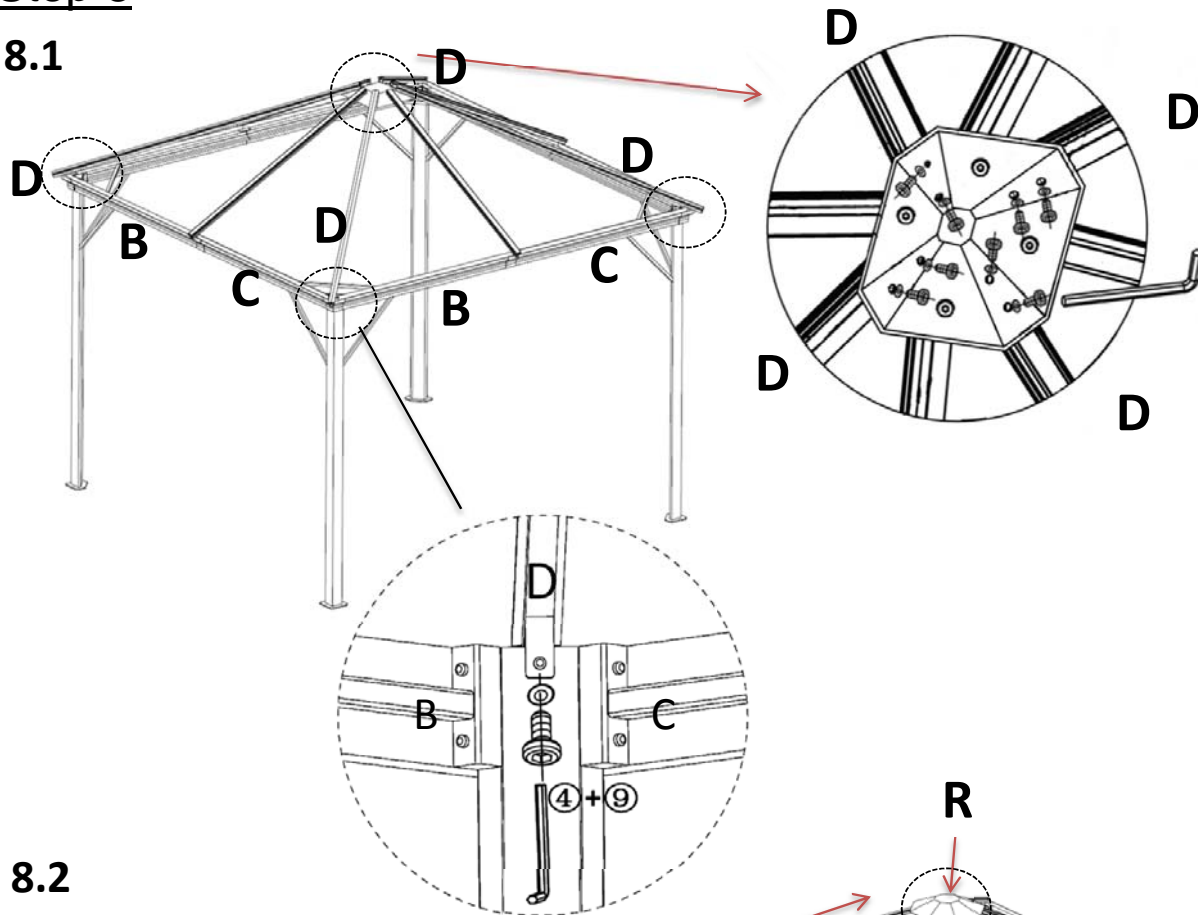

8.2

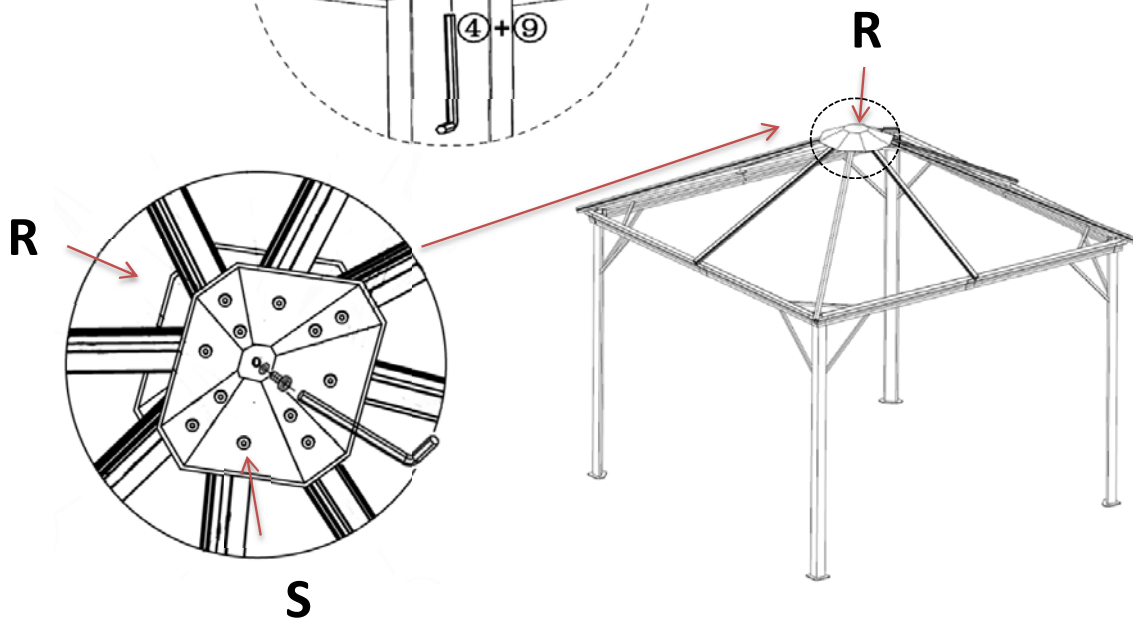

8.1) Attach Long Corner Roof Bars(D) to Inside Roof Connector(S) using Bolts(④) and Washers(⑨) with Allen Key(⑦).

Then, attach Long Corner Roof Bars(D) to Columns(A) using Bolts(④) and Washers(⑨) with Allen Key(⑦).

8.2) Last attach the Outside Roof Connector(R) to Inside Roof Connector(S) using Bolt(④) and Washer(⑨) with Allen Key(⑦).

Tighten the Bolts fully in a sequential manner.

Step 9

Roof Panel: Thick Face Up, Thin Face Down

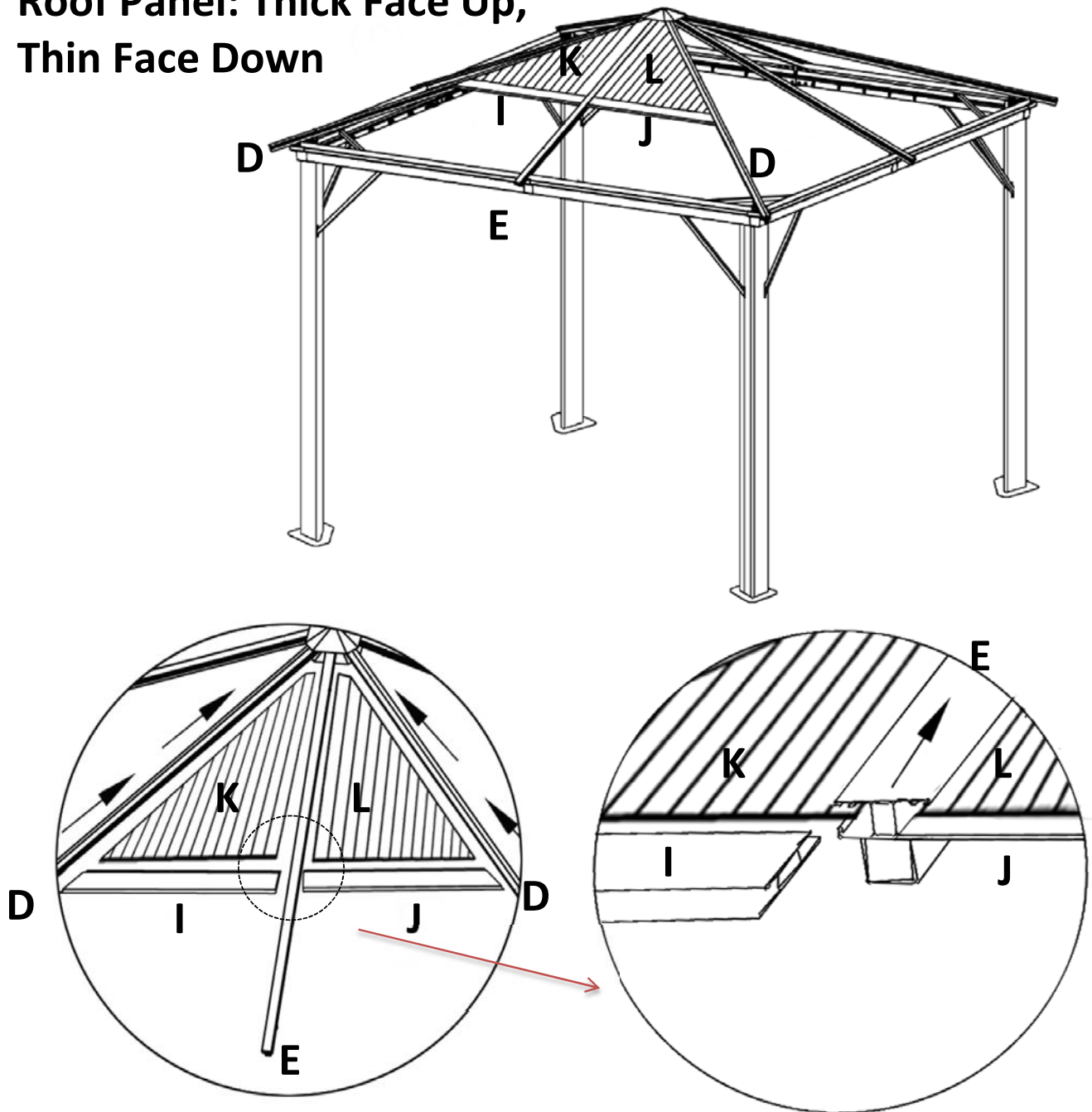

From the end of the Long Corner Roof Bars(D), insert Roof Panel(K) and Roof Panel(L) into the Roof Bar's upper tracks as pictured above.

Note: Ensure they are completely inserted in the tracks.

Then, insert the Roof Support Bar(I) and Roof Support Bar(J) into the Roof Bar's upper tracks as pictured above.

Note: Please remove the white protective film from the Panels before assembly. The white protective film side is the face.

Step 10

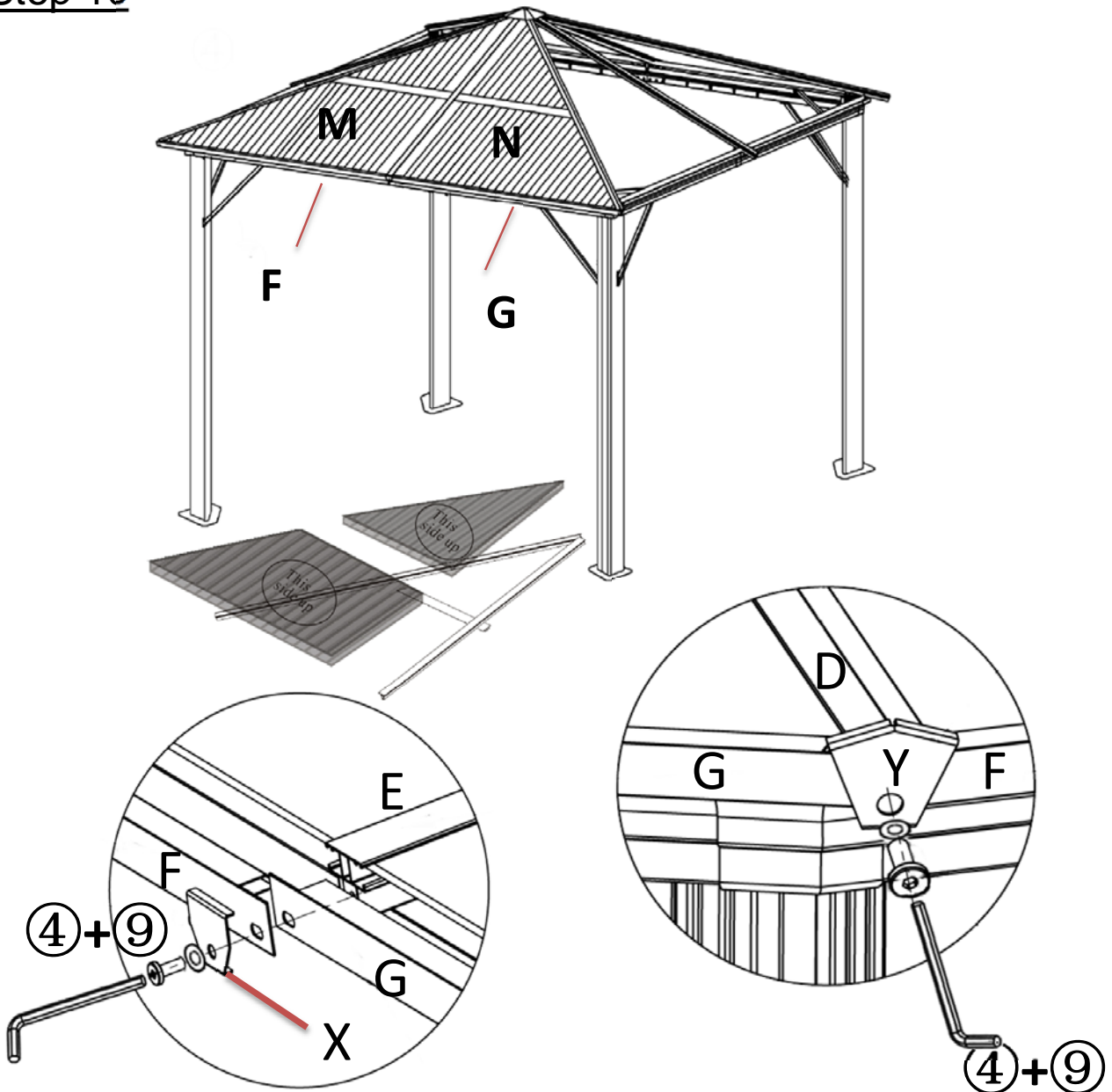

Insert the Roof Panel(M) and Roof Panel(N) into the Roof Bar's bottom tracks as pictured above.

Note: Ensure they are completely inserted in the tracks.

Insert the Roof Finishing Bar(G) and Roof Finishing Bar(F) into the Roof Bar's bottom tracks as pictured above.

Attach Finishing End(X), Roof Finishing Bar(G) and Roof Finishing Bar(F) to Roof Bar(E) using Bolt(④) and Washer(⑨) with Allen Key(⑦).

Attach Corner Finishing End(Y) to Long Corner Roof Bar(D) using Bolt(④) and Washer(⑨) with Allen Key(⑦).

Repeat the process from Step 9 and Step 10 three times.

Tighten all Bolts fully in a sequential manner.

Note: Please remove the white protective film from the Panels before assembly. The white protective film side is the face.

Step 11

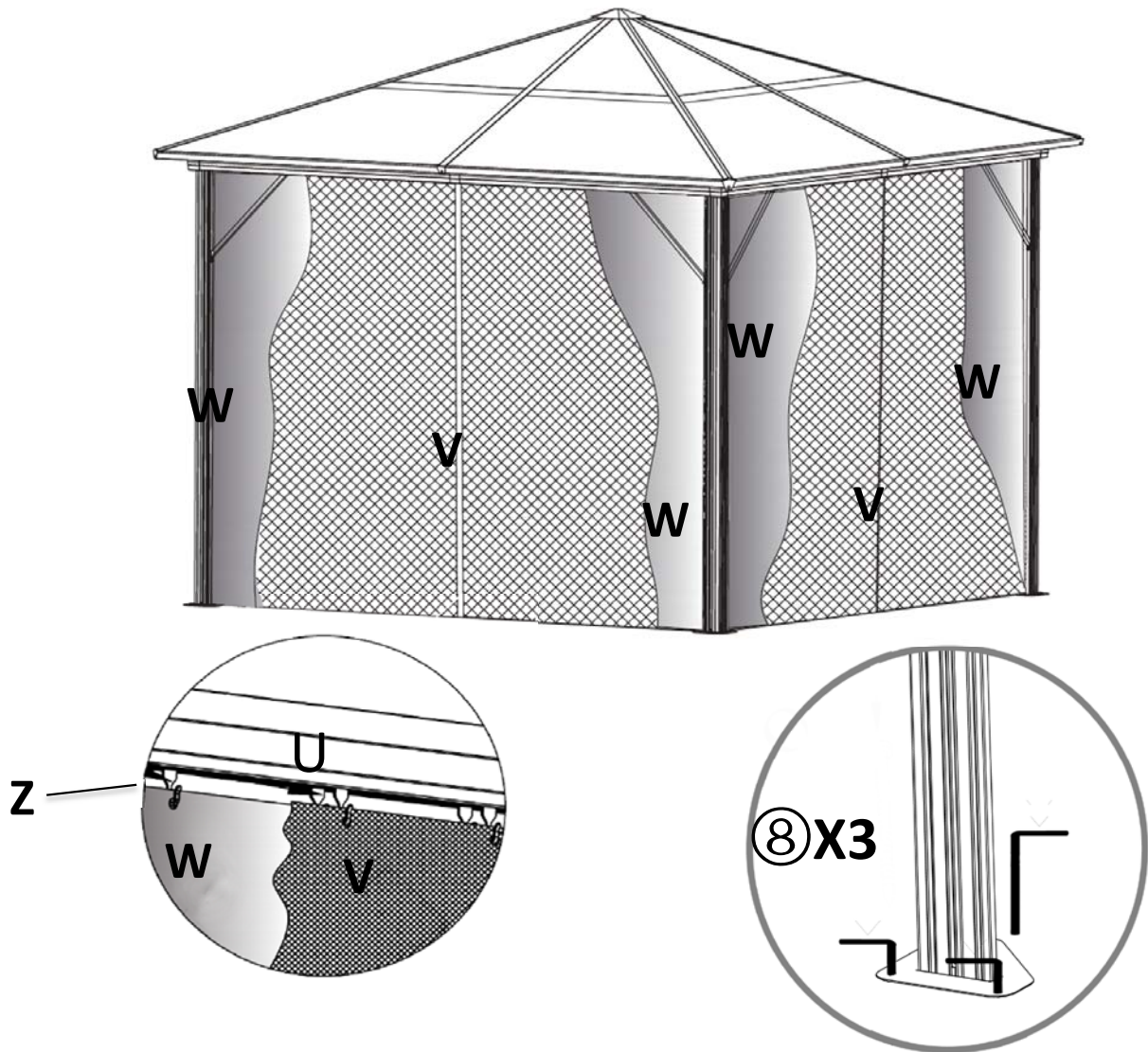

11.1) Install the Mosquito Netting(V) along the inside Tracks(U) on the Hooks(Z).

11.2) Install the Curtains(W) along the outside Tracks(U) on the Hooks(Z).

11.3) Affix the Gazebo to the ground by inserting the Stakes(8) through the Bases(T).
Your Gazebo is ready for use.













This Gazebo can only be used on a flat, level surface.



CAUTIONS:

1. Check stability and then tighten the Bolts.
2. DO NOT tighten any Bolts fully and then move on towards the next one. Rather, in a sequential manner, gradually tighten each Bolt until all Bolts are evenly secured. This methodology will ensure maximum evenness once all Bolts are fully tightened
3. Inspect it and make sure all parts are adequately connected.

WARNING! IF GAZEBO IS NOT STABLE, IT COULD LEAD TO DAMAGE TO THE PRODUCT.

Care & Maintenance

-   ● Do not put hot items directly on furniture surface
-   ● Do not clean furniture with harsh cleansers or polish.
-   ● Children should not climb or jump on the furniture.
-   ● Do not write on furniture without a padded barrier to protect the surface.
-   ● Not for commercial use. For residential use only .
-   ● Stains may be removed with mild soap solution and damp cloth.

-
-   ● Dust and pick-up spills using a clean, non-colored, lint-free cloth .

What is Proposition 65?

Proposition 65 is a California law that requires warning labels on products that may contain one of more than 800-plus chemicals or ingredients that the California Office of Environmental Health Hazard Assessment (OEHHA) has deemed to cause cancer or other reproductive toxicity. Chemicals and elements on this list include wood dust, brass, and other everyday substances, which can be found in very common household items, such as: lamps, tableware, jewelry, crystal glasses, electric cords, beauty products, automobiles, and furniture.

Why Did I Find a Proposition 65 Warning on My Home Goods Product?

We include Proposition 65 warnings on all of our products because there is always a chance that one of the 800-plus common chemicals and ingredients listed under this law could potentially be on our furniture or packing materials. We risk large fines under this law, if we don't include this warning.

Should I worry?

We realize you may be worried finding this warning on our products, but we want to reassure you that the hazardous exposure limits for any of these chemicals have never been found on furniture products that we've shipped to our customers. Additionally, this warning label is very common and can be found on almost every piece of furniture sold in the state of California.

Just How Common Are Proposition 65 Warnings?

Proposition 65 warnings have become so common in California that it is hard to take a trip to a local bank, grocery store, or restaurant without finding at least one warning. In fact, even the Disneyland Resort has a Proposition 65 warning:

