



**MODEL N° 90022**

***OWNER'S MANUAL***

**COPY**

Keep this Identification Number in case you must contact our Customer Service Department.

## REGISTER YOUR PRODUCT ONLINE AT [WWW.LIFETIME.COM](http://WWW.LIFETIME.COM)

At Lifetime, we are committed to providing innovative and quality products. While registering, you will have the opportunity to give us your feedback. Your input is valuable to us.

- You can also opt in to receive new product notifications or promotions.
- In the unlikely event of a product recall or safety modification, your registration provides the information we need to notify you directly.
- Registration is fast, easy, and completely voluntary.

### LIFETIME'S PROMISE TO YOU:

*Maintaining your privacy is our long-standing policy at Lifetime. And you can rest assured that Lifetime will not sell or provide your personal data to other third parties, or allow them to use your personal data for their own purposes.*

We invite you to read our privacy policy at [www.lifetime.com](http://www.lifetime.com)

**REGISTER today!**

**Save this instruction in the event that the manufacturer has to be contacted for replacement parts.**

**\*\*U.S. and Canada customers ONLY\*\***

IF ASSISTANCE IS NEEDED,

**DO NOT CONTACT THE STORE!**

**CALL OUR CUSTOMER SERVICE DEPARTMENT at 1 (800) 225-3865**

HOURS: 7:00 a.m. to 5:00 p.m. Monday through Friday (Mountain Standard Time)

\*\*Call, or visit our Web site for Saturday hours\*\*

\*\*For customers outside the U.S. or Canada, please contact the store for assistance.\*\*



## SAFETY INSTRUCTIONS



**FAILURE TO FOLLOW THESE WARNINGS MAY RESULT IN SERIOUS INJURY OR PROPERTY DAMAGE AND WILL VOID WARRANTY.**

To ensure safety, do not attempt to assemble this system without following the instructions carefully. Check entire box and inside all packing material for parts and/or additional instruction material. Before beginning assembly, read the instructions and identify parts using the hardware identifier and parts list in this document. Proper and complete assembly, use and supervision are essential for proper orientation and to reduce the risk of accident or injury. A high probability of serious injury exists if this system is not installed, maintained, and/or operated properly.

- If using a ladder during assembly, use extreme caution.
- Two capable adults are recommended for this operation.
- Check base daily for leakage. Leaks may cause system to fall.
- Assemble the pole sections properly. Failure to do so could cause the pole sections to separate during play or transport.

***Most injuries are caused by misuse and/or not following instructions. Use caution when using this system.***



### WARNING

To ensure your safety, do not attempt to assemble this system without reading and following all instructions carefully. Identify and inventory the parts using the Parts List. Failure to comply with any of the warnings in these instructions may result in serious personal injuries such as cuts, broken bones, nerve damage, paralysis, brain injury, or death. Failure to comply may also result in property damage. Please heed all warnings and cautions.

## BEFORE BEGINNING ASSEMBLY

- A. Keep the hardware bags and their contents separate. If any parts are missing, call our Customer Service Department.
- B. Test fit all Bolts by inserting them into their respective holes. If necessary, carefully scrape away any excess powder coating buildup from inside the holes. Do not scrape away all of the powder coating. Bare metal may rust. You may need to pound some Bolts into place with a hammer or mallet.

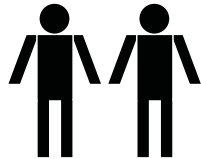

***\*Two adults required to complete assembly\****



## TOOLS AND PARTS REQUIRED FOR THIS ASSEMBLY

7/16" Wrench



(2)

1/2" Wrench



(2)

9/16" Wrench



(2)

Phillips Screwdriver



(1)

Pliers



(1)

Funnel

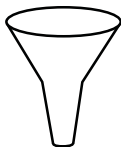

(1)

Scrap Wood



(1)

Sand



(120 lb)

Water Hose



(1)

## ASSEMBLY GUIDES

*Refer to the following areas throughout the instructions to assist in the assembly process:*

This area is located at the top, left-hand corner of the page and indicates which tools and hardware are needed to complete the assembly steps on a page.



**TOOLS AND HARDWARE REQUIRED FOR THIS PAGE**



This area is located at the top, right-hand corner of the page and shows an image of the product with shaded parts indicating which section is being assembled.

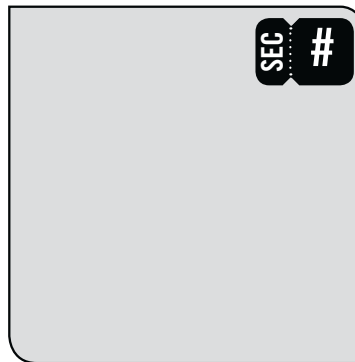

This area is usually located in the bottom, left-hand corner of a step and indicates that special attention is needed to perform a particular part of a step.



*Note:*

These areas are usually located in the bottom, right-hand corner of a step and indicate that damage to the product or serious injury may occur if the caution or warning is not heeded.



**CAUTION**



**WARNING**

## PARTS LIST

<u>ID</u>	<u>Description</u>	<u>Qty</u>	<u>✓</u>
ALH	Top Pole	1	<input type="checkbox"/>
ALF	Middle Pole	1	<input type="checkbox"/>
ALE	Bottom Pole	1	<input type="checkbox"/>
ALK	Right Brace Assembly	1	<input type="checkbox"/>
ALI	Left Brace Assembly	1	<input type="checkbox"/>
AJI	Backboard	1	<input type="checkbox"/>
AMY	Backboard Bracket	2	<input type="checkbox"/>
ALX	Rim	1	<input type="checkbox"/>
AJM	Base	1	<input type="checkbox"/>
AMU	Wheel	2	<input type="checkbox"/>
AKZ	Net	1	<input type="checkbox"/>
AMT	Warning Sticker (Applied to Middle Pole)	1	<input type="checkbox"/>

## HARDWARE LIST

<u>ID</u>	<u>Description</u>	<u>Qty</u>	<u>✓</u>
<b>DUJ</b>	<b>Hardware Blister Pack</b>		
ACN	1/4" Adjustment Knob	1	<input type="checkbox"/>
ACL	1/4" x 2 1/2" Carriage Bolt	1	<input type="checkbox"/>
ADS	1/4" x 3/4" Screw	2	<input type="checkbox"/>
AJB	1/2" x 4" Axle	2	<input type="checkbox"/>
AJG	5/16" x 2" Axle	2	<input type="checkbox"/>
ACU	1/4" x 2.2" Shoulder Bolt	1	<input type="checkbox"/>
ABW	1/4" Hex T-Nut	1	<input type="checkbox"/>
AAT	3/8" Fender Washer	1	<input type="checkbox"/>
AAF	3/8" Flat Washer	1	<input type="checkbox"/>
ACO	3/8" x 1 1/4" Tap Bolt	1	<input type="checkbox"/>
ACM	5/16" x 2 3/4" Hex Bolt	2	<input type="checkbox"/>
AAN	5/16" Cap Nut	2	<input type="checkbox"/>
AEC	5/16" Flat Washer	4	<input type="checkbox"/>
ACV	5/16" x 5/8" Screw for Plastic	6	<input type="checkbox"/>
AZY	Base Plug	1	<input type="checkbox"/>

# PARTS IDENTIFIER

## MISCELLANEOUS PARTS

Parts shown at 10% of Actual Size

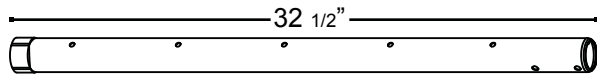

**ALH (x1)**  
Top Pole (Do not remove this pole from inside the Middle Pole)

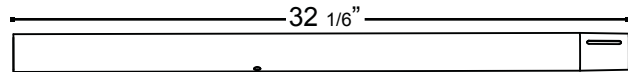

**ALE (x1)**  
Bottom Pole

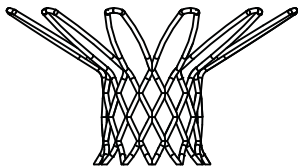

**AKZ (x1)**  
Net

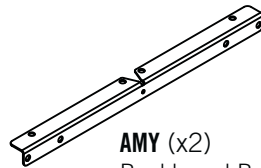

**AMY (x2)**  
Backboard Bracket

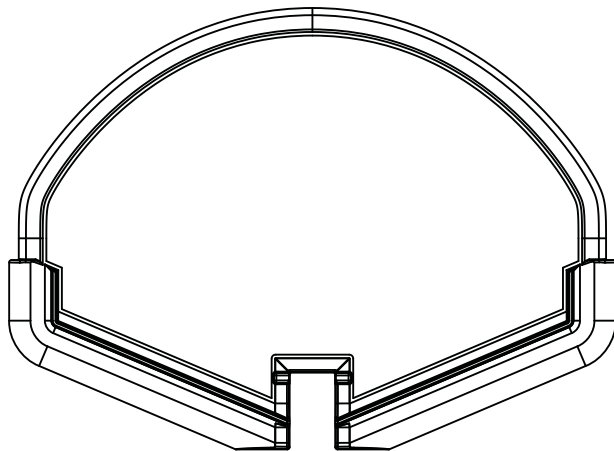

**AJI (x1)**  
Backboard

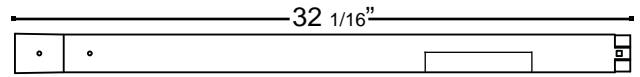

**ALF (x1)**  
Middle Pole



**ALK (x1)**  
Right Brace Assembly

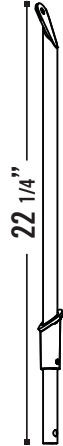

**ALI (x1)**  
Left Brace Assembly

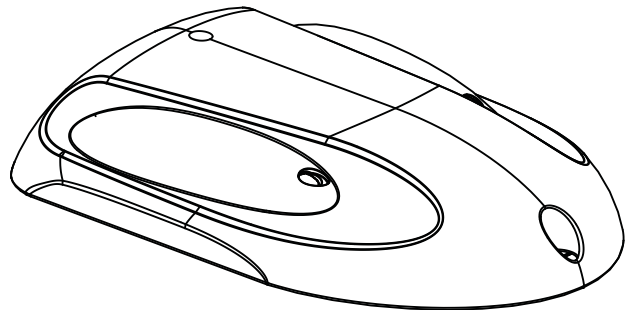

**AJM (x1)**  
Base

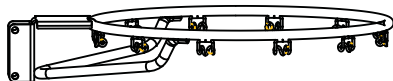

**ALX (x1)**  
Rim

Part shown at 25% of Actual Size

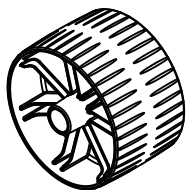

**AMU (x2)**  
Wheel

**AMT (x1)**  
Warning Sticker (on Middle Pole)



# PARTS IDENTIFIER

## HARDWARE BLISTER PACK

All hardware shown at actual size

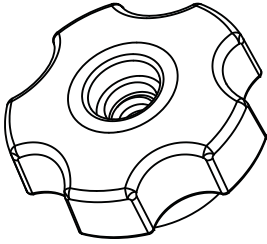

**ACN (x1)**  
1/4" Adjustment Knob

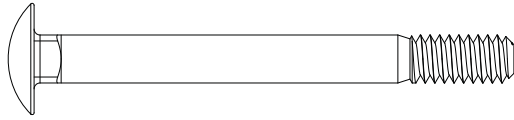

**ACL (x1)**  
1/4" x 2 1/2" Carriage Bolt

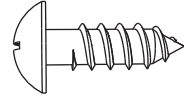

**ADS (x2)**  
1/4" x 3/4" Pole Joint Screw

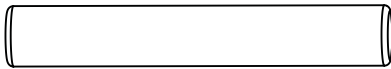

**AJG (x2)**  
5/16" x 2" Brace Axle

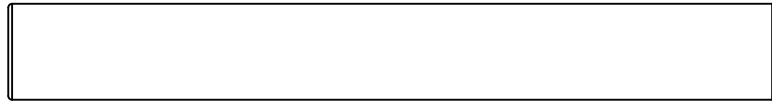

**AJB (x2)**  
1/2" x 4" Axle

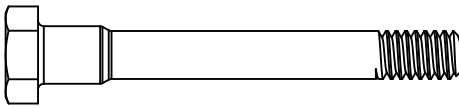

**ACU (x1)**  
1/4" x 2.2" Shoulder Screw

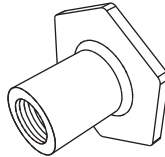

**ABW (x1)**  
1/4" Hex T-Nut

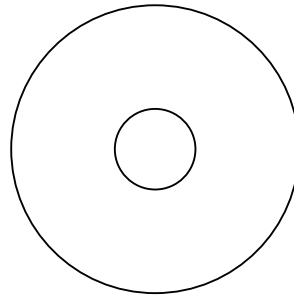

**AAT (x1)**  
3/8" Fender Washer

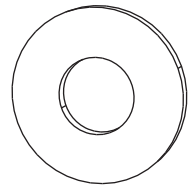

**AAF (x1)**  
3/8" Flat Washer

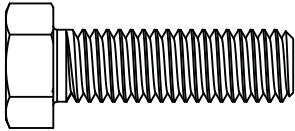

**ACO (x1)**  
3/8" x 1 1/4" Tap Bolt

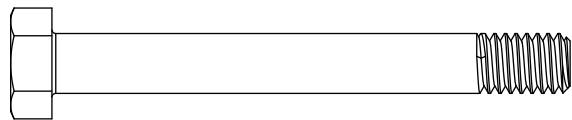

**ACM (x2)**  
5/16" x 2 3/4" Hex Bolt

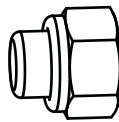

**AAN (x2)**  
5/16" Cap Nut

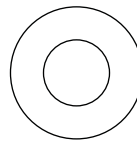

**AEC (x4)**  
5/16" Flat Washer

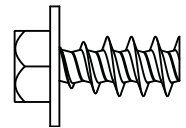

**ACV (x6)**  
5/16" x 5/8" Screw  
for Plastic

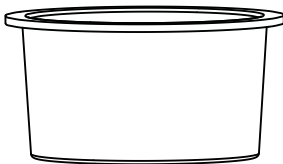

**AZY (x1)**  
1 1/4" Base Plug

# SEC 1 POLE ASSEMBLY

## HARDWARE REQUIRED

Hardware shown at Actual Size



**ACL (x1)**  
1/4" x 2 1/2" Carriage Bolt

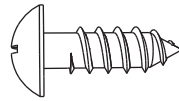

**ADS (x2)**  
1/4" x 3/4" Pole Joint Screw

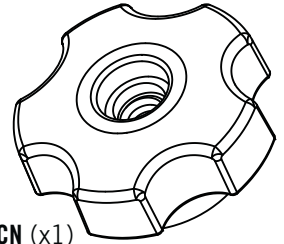

**ACN (x1)**  
1/4" Adjustment Knob

## PARTS REQUIRED

Parts shown at 10% of Actual Size

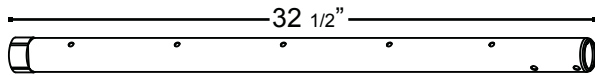

**ALH (x1)**  
Top Pole (Do not remove this pole from inside the Middle Pole)

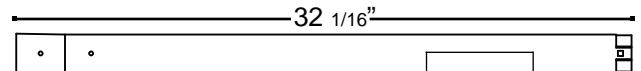

**ALF (x1)**  
Middle Pole

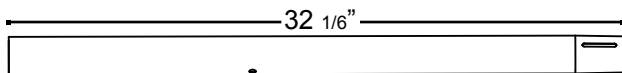

**ALE (x1)**  
Bottom Pole

## TOOLS REQUIRED

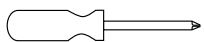

#2 Phillips Screwdriver





## TOOLS AND HARDWARE REQUIRED FOR THIS PAGE

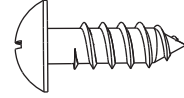
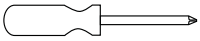

ADS (x1)

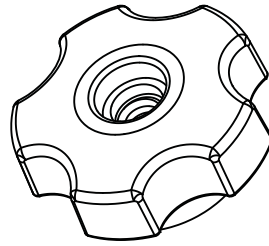

ACN (x1)

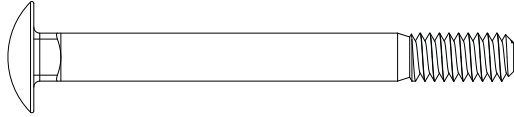

ACL (x1)

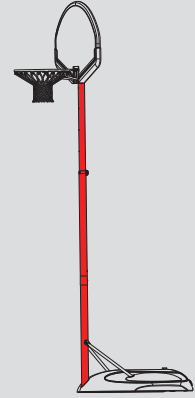

SEC 1

SEC

1.1

Do Not Remove the **Top Pole (ALH)** from inside the **Middle Pole (ALF)**. Remove the plastic from the Top Pole.

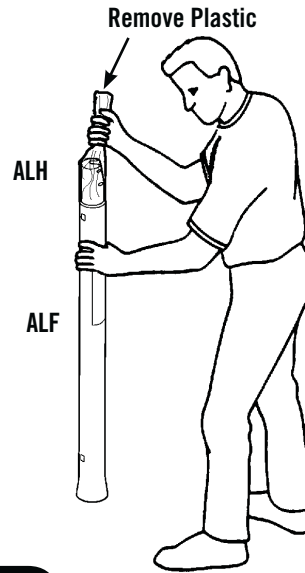

**!** *Note: If needed, reinsert the Top Pole into the Middle Pole by sliding the Top Pole up through the bottom of the Middle Pole.*

SEC

1.2

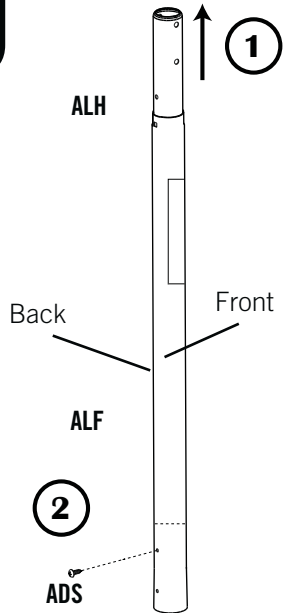

**!** *Note: Insert the Screw until the Screw Head is flush with the Pole. The Screw will spin freely once completely inserted.*

SEC

1.3

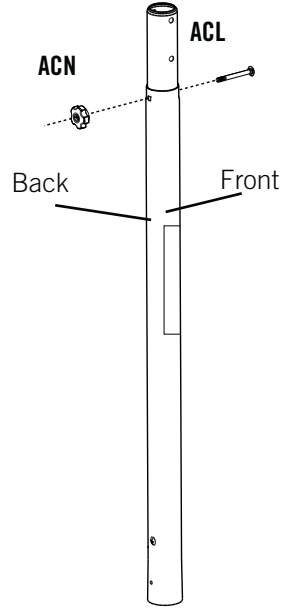

**!** *Note: The Knob (ACN) will face the back of the system.*



## TOOLS AND HARDWARE REQUIRED FOR THIS PAGE

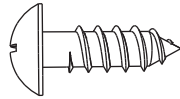
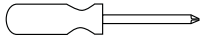

ADS (x1)

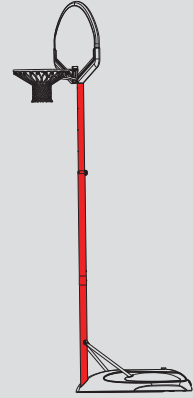

SEC 1

SEC 1.4

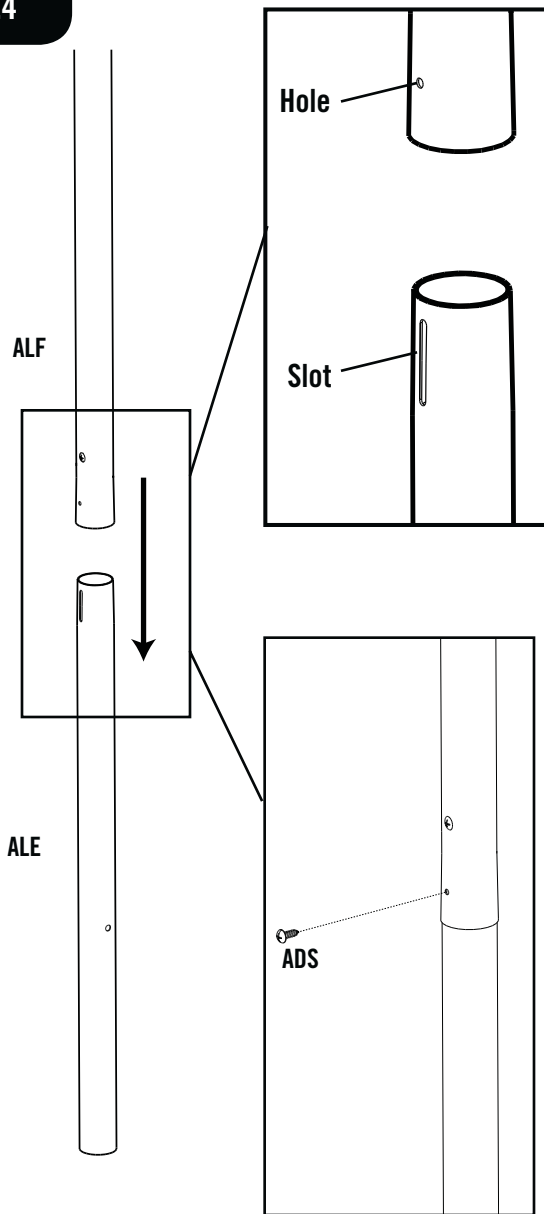

SEC 1.5

### \*THIS STEP CANNOT BE REVERSED\*

Strike the bottom end of the Pole firmly five to six times. If the **Middle Pole** does not completely cover the slot on the **Bottom Pole** after seating, **DO NOT COMPLETE ASSEMBLY**. Call Customer Service.

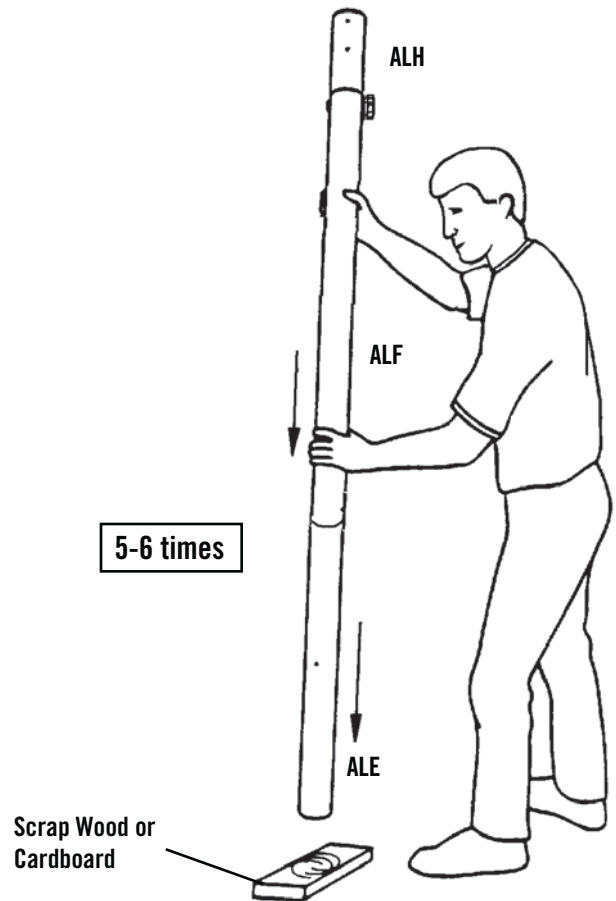

Scrap Wood or Cardboard



*Note: Do not hit your feet with the Pole sections, as serious injury could occur.*



## WARNING

The Poles must be seated together! Even if the Poles cover the slots before seating, they must be struck on a hard surface five to six times! Failure to seat the Poles correctly could allow the Poles to separate during use, which could lead to serious personal injuries or property damage.

**SEC 2 BASE ASSEMBLY**

**HARDWARE REQUIRED**

Hardware shown at Actual Size

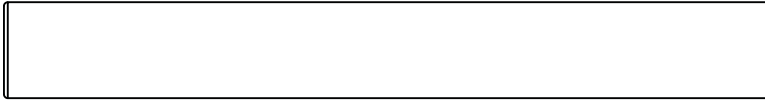

**AJB** (x2)  
1/2" x 4" Axle

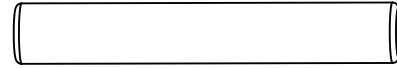

**AJG** (x2)  
5/16" x 2" Brace Axle

**PARTS REQUIRED**

Parts shown at 10% of Actual Size

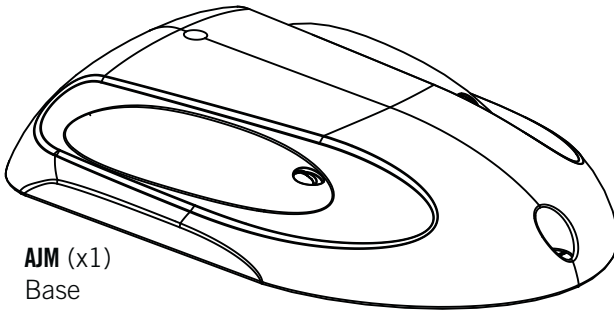

**AJM** (x1)  
Base

Parts shown at 25% of Actual Size

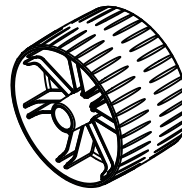

**AMU** (x2)  
Wheel



**ALK** (x1)  
Right Brace  
Assembly

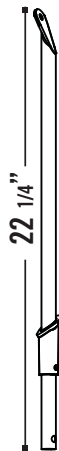

**ALI** (x1)  
Left Brace  
Assembly

**TOOLS REQUIRED**

**NO TOOLS REQUIRED FOR THIS SECTION**



**TOOLS AND HARDWARE REQUIRED FOR THIS PAGE**

**NO TOOLS REQUIRED FOR THIS PAGE**

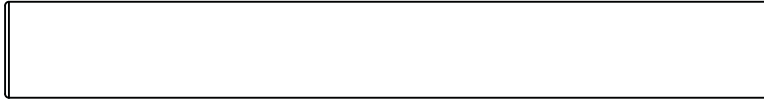

AJB (x2)

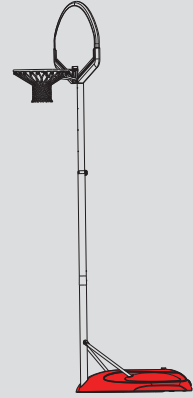

**SEC 2**

**SEC**

**2.1**

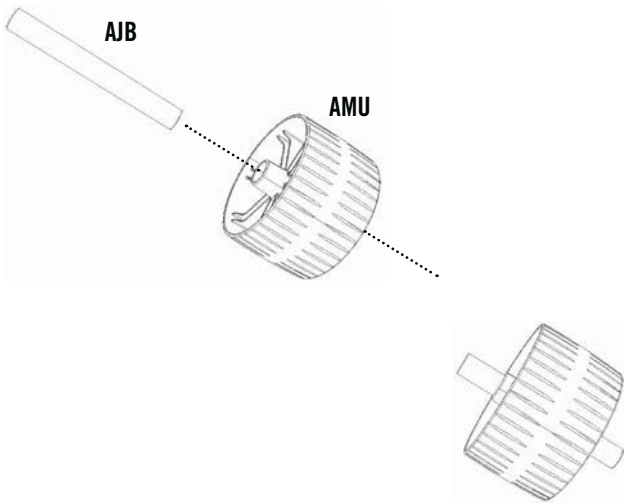

**SEC**

**2.2**

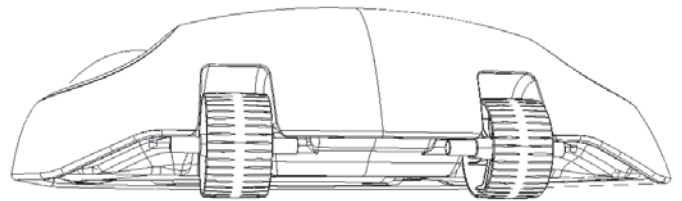

**SEC**

**2.3**

**Press down over the Wheels  
to snap the Axles in place.**

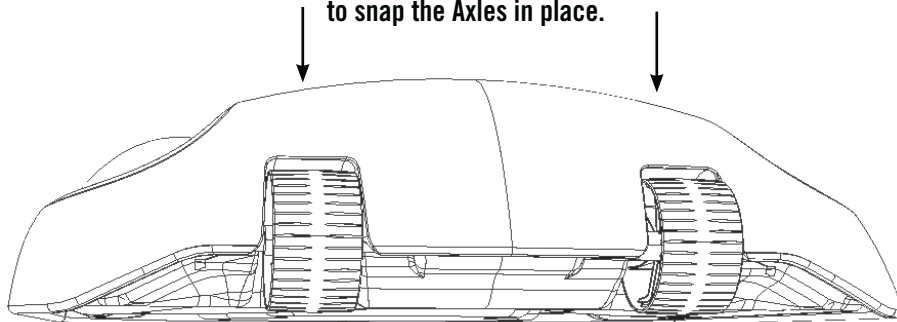

*Note: Check to be sure that both Axles snapped securely in place.*



**TOOLS AND HARDWARE REQUIRED FOR THIS PAGE**

**SEC 2**

**NO TOOLS OR HARDWARE REQUIRED FOR THIS PAGE**

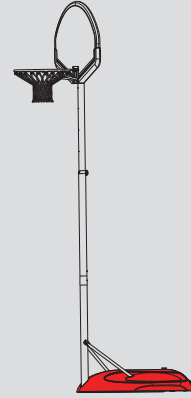

**Bottom View**

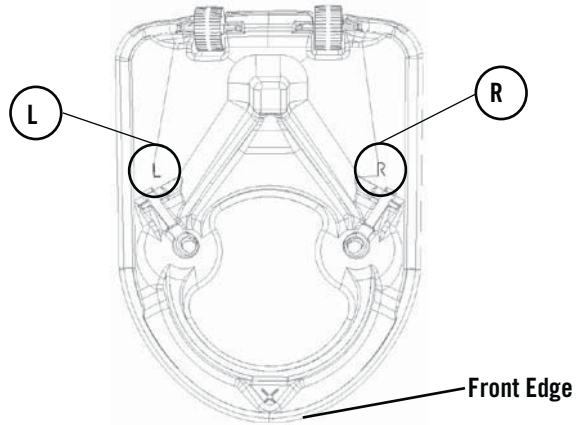

**SEC 2.4**

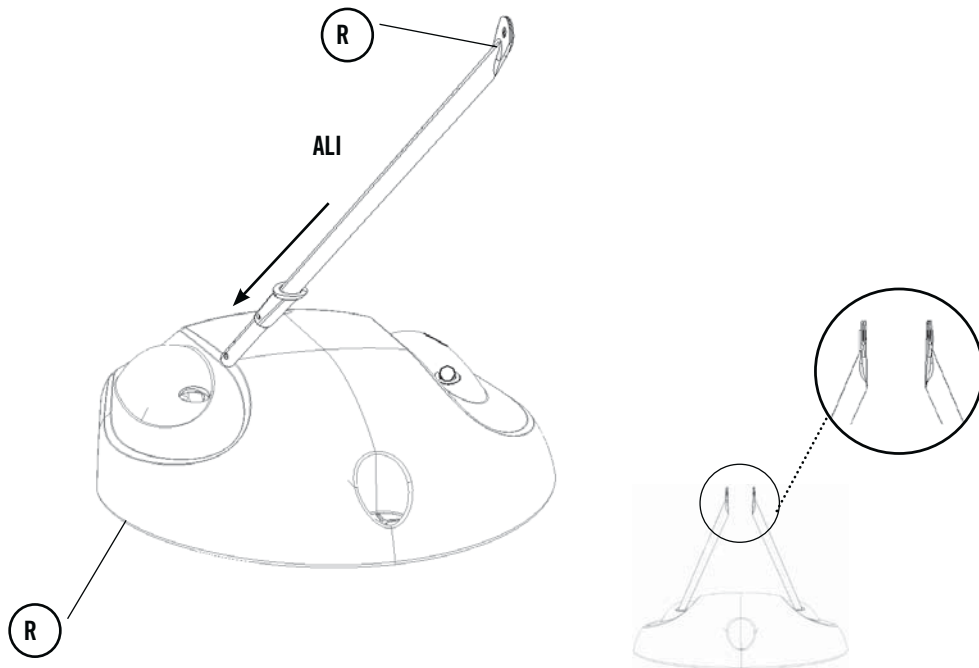



**TOOLS AND HARDWARE REQUIRED FOR THIS PAGE**

**NO TOOLS REQUIRED FOR THIS PAGE**

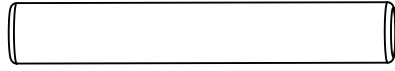

AJG (x2)

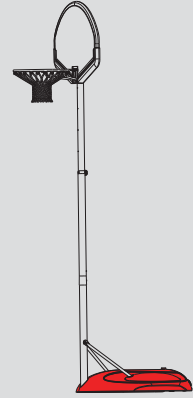

SEC 2

SEC

2.5

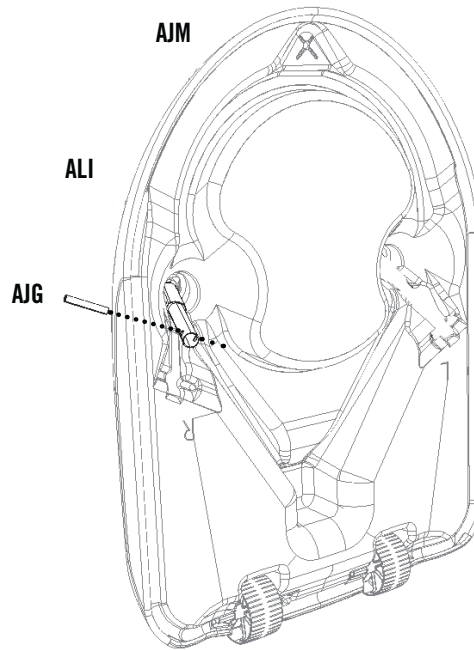

SEC

2.6

Repeat steps 2.4 - 2.6 for the **Left Brace Assembly (ALK)**.

Push Pole Brace forward to snap the Axle in place.

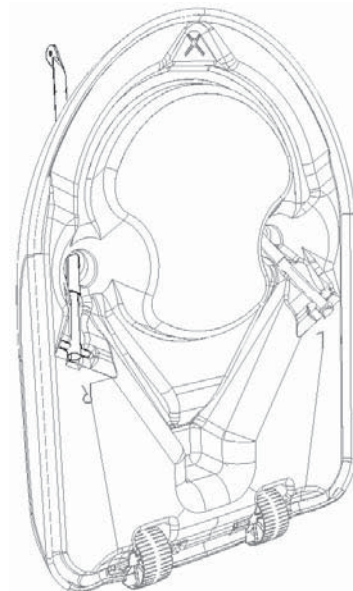
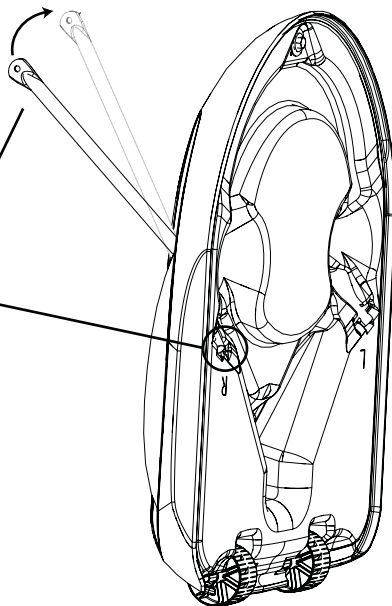

**SEC 3 POLE TO BASE ASSEMBLY**

**HARDWARE REQUIRED**

Hardware shown at Actual Size

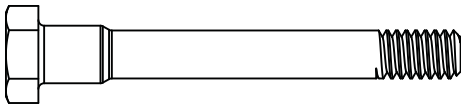

**ACU (x1)**  
1/4" x 2.2" Shoulder Bolt

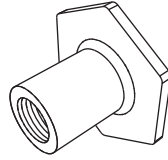

**ABW (x1)**  
1/4" Hex T-Nut

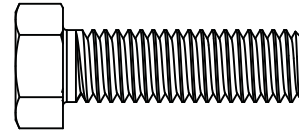

**ACO (x1)**  
3/8" x 1 1/4" Tap Bolt

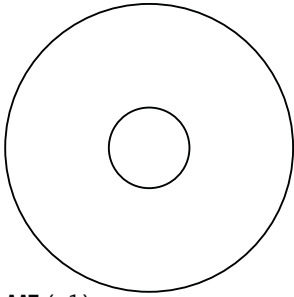

**AAT (x1)**  
3/8" Fender Washer

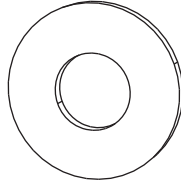

**AAF (x1)**  
3/8" Flat Washer

**PARTS REQUIRED**

**NO PARTS REQUIRED FOR THIS SECTION**

**TOOLS REQUIRED**



**9/16" Wrench**



**7/16" Wrench**



**Pliers**



## TOOLS AND HARDWARE REQUIRED FOR THIS PAGE



7/16"

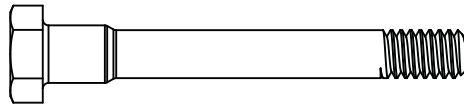

ACU (x1)

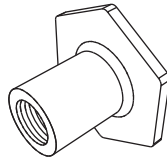

ABW (x1)

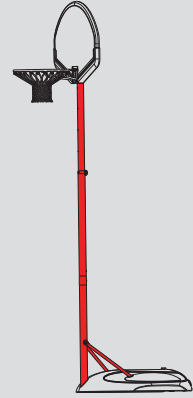

SEC 3

SEC  
3.1

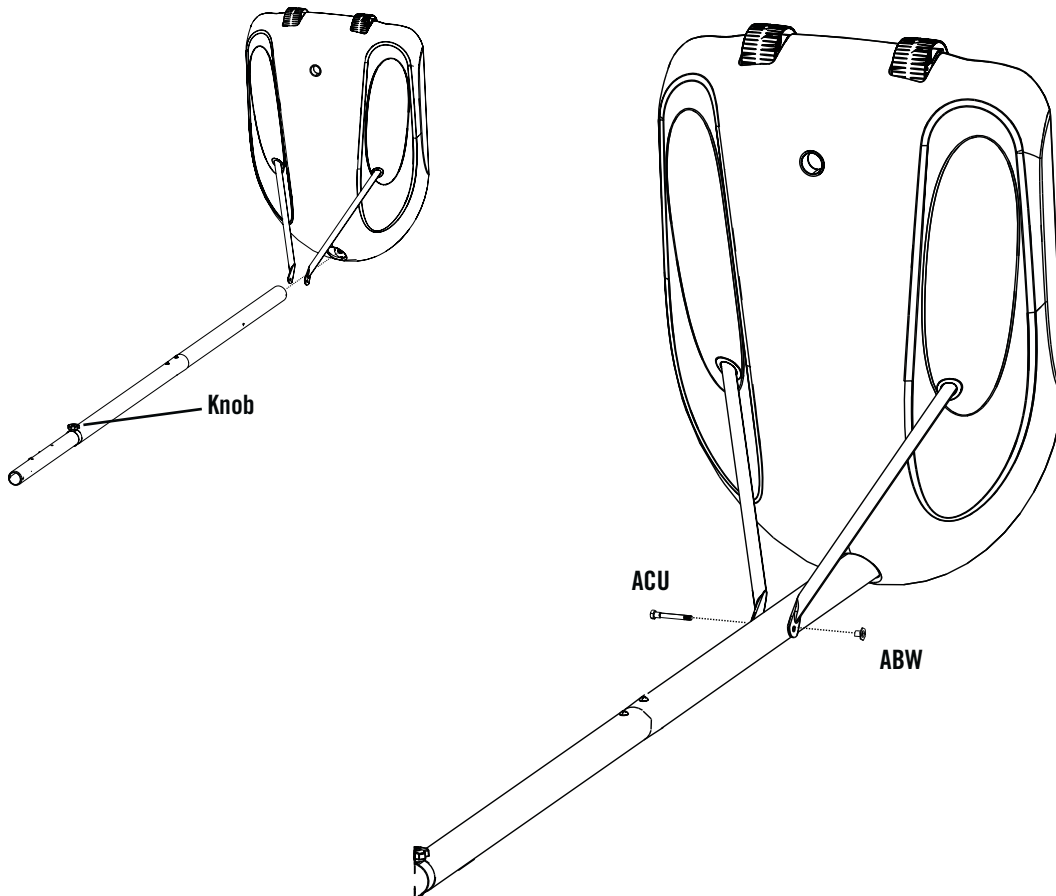

*Note: The Bolt will not go through the entire width of the Pole. Use Pliers to hold the T-Nut in place.*





# TOOLS AND HARDWARE REQUIRED FOR THIS PAGE



9/16"

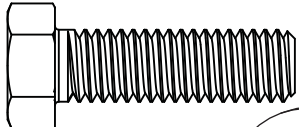

ACO (x1)

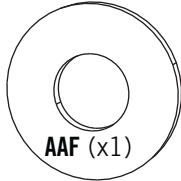

AAF (x1)

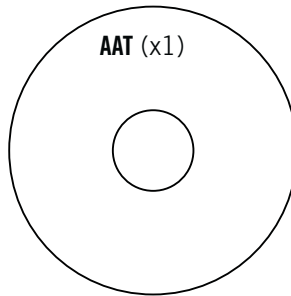

AAT (x1)

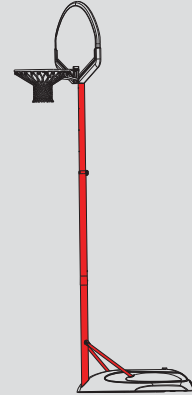

SEC 3

SEC

3.2

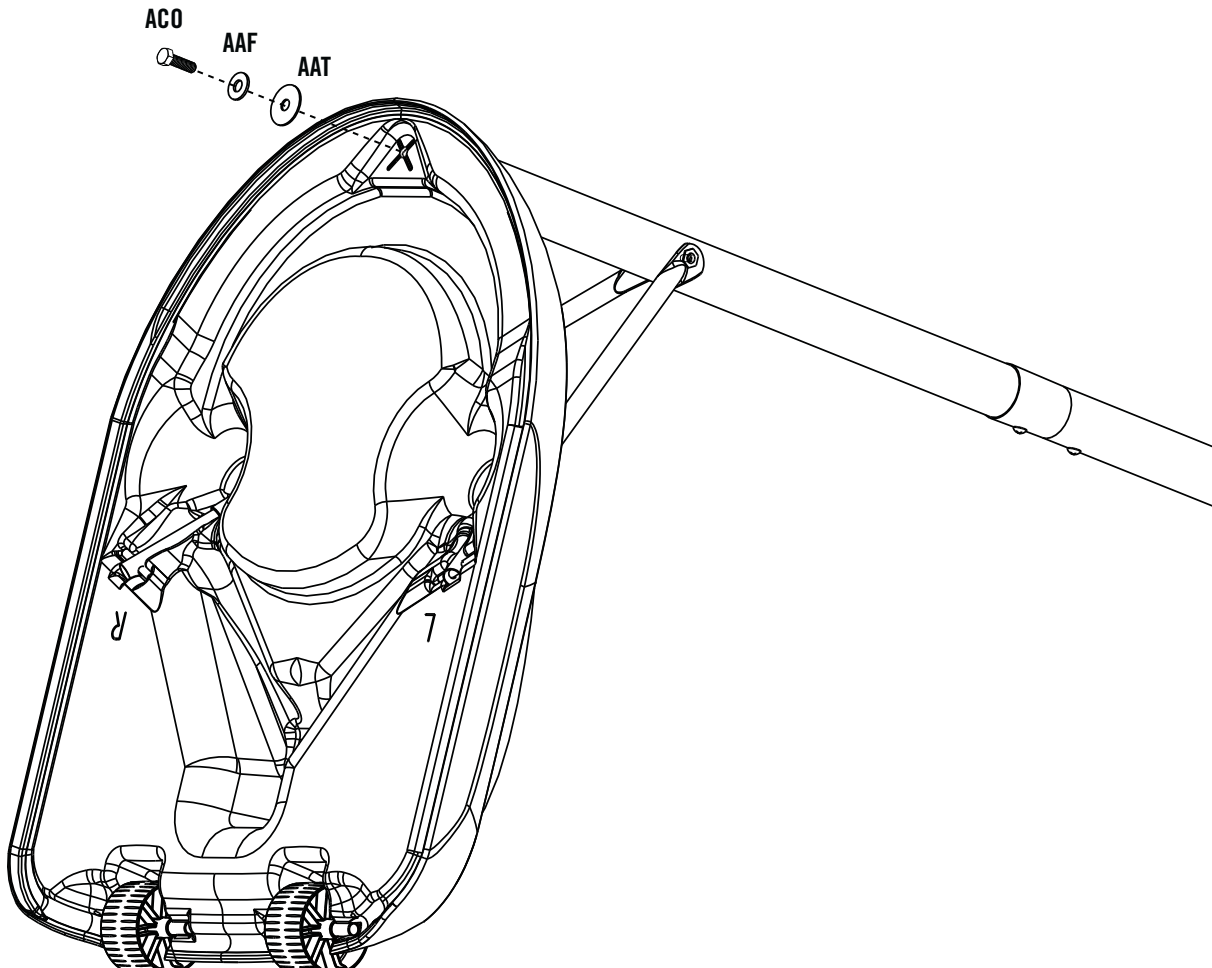

Note: Completely tighten the hardware.



## WARNING

Never put the system in an upright position without proper weight in the Base. The system may fall over and could result in serious personal injury or property damage.

## SEC 4 FILLING THE BASE

### *HARDWARE REQUIRED*

Hardware shown at Actual Size

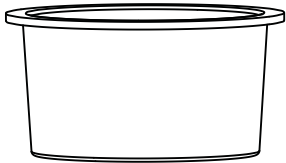

**AZY (x1)**  
Small Base Plug

### *PARTS REQUIRED*

**NO PARTS REQUIRED FOR THIS SECTION**

### *TOOLS REQUIRED*



**Sand**  
(120 lb)



**Water Hose**

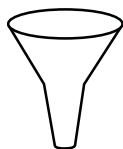

**Funnel**



## TOOLS AND HARDWARE REQUIRED FOR THIS PAGE

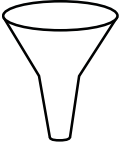

(120 lb)

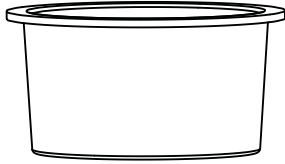

AZY (x1)

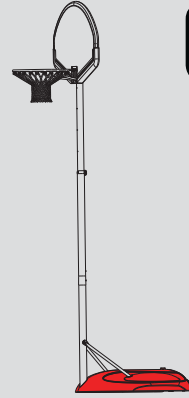

SEC 4

SEC

4.1

### FILLING THE BASE WITH SAND

While one adult holds the pole use a funnel to add sand through the hole in the top of the **Base (AJM)** until it is just below the hole (Fig. 1).

Using two adults, carefully pull the system up until it is almost upright..  
Finish filling the base with sand (Fig. 2).  
Insert the **Base Plug (AZY)** into the fill hole.

Figure 1

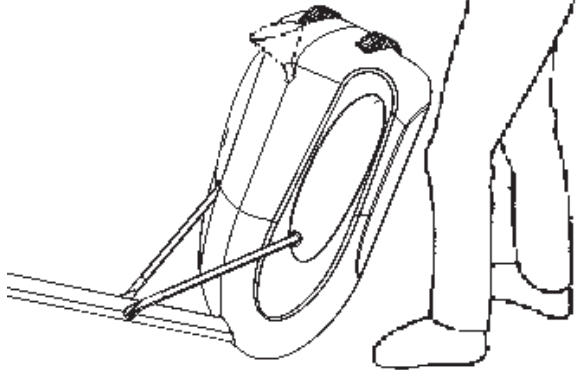
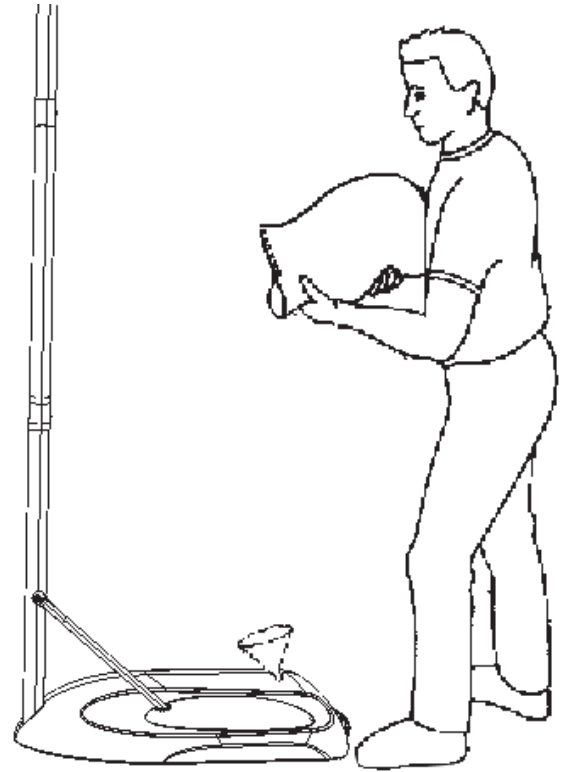

Figure 2



### WARNING

For safety reasons, we recommend that sand be used instead of water to fill the Base. If a leak develops, water could run out unnoticed, allowing the system to fall over, resulting in serious personal injuries, or property damage. If using Water, check the Base carefully for leaks. If a leak is found, lay the system down on the ground and call Customer Service. Do not use, stand up, or play on a leaking system.



## TOOLS AND HARDWARE REQUIRED FOR THIS PAGE

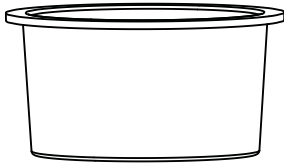

AZY (x1)

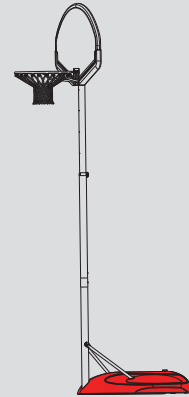

SEC 4

SEC

4.1

### FILLING THE BASE WITH WATER

While one adult holds the pole, add water through the hole in the top of the **Base (AJM)** until it is just below the hole (Fig. 1).

Add one tablespoon of chlorine bleach to the water in the Base.  
Using two adults, carefully pull the system up until it is almost upright.  
Finish filling the base with water (Fig. 2).  
Insert the **Base Plug (AZY)** into the fill hole.



Figure 1



Figure 2



### WARNING

For safety reasons, we recommend that sand be used instead of water to fill the Base. If a leak develops, water could run out unnoticed, allowing the system to fall over, resulting in serious personal injuries, or property damage. If using Water, check the Base carefully for leaks. If a leak is found, lay the system down on the ground and call Customer Service. Do not use, stand up, or play on a leaking system.

### When Using Water

1. Make sure the surface beneath the Base is smooth and free of stones, gravel, or sharp objects that could puncture the Base and cause leakage.
2. Check the Base frequently for cracks or punctures.
3. Always check the water level before play.
4. If the system is to be stored without weight in the base, tilt it forward and rest the Rim on the ground.
5. Every time the Base is filled with water, add one tablespoon of chlorine bleach to the water to prevent algae formation in the Base.

## SEC 5 BACKBOARD AND RIM ASSEMBLY

### HARDWARE REQUIRED

Hardware shown at Actual Size

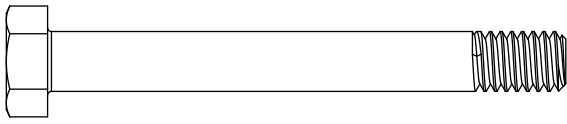

**ACM** (x2)  
5/16" x 2 3/4" Hex Bolt

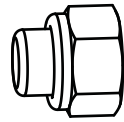

**AAN** (x2)  
5/16" Cap Nut

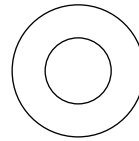

**AEC** (x4)  
5/16" Flat Washer

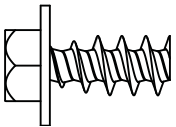

**ACV** (x6)  
5/16" x 5/8" Screw for Plastic

### PARTS REQUIRED

Parts shown at 10% of Actual Size

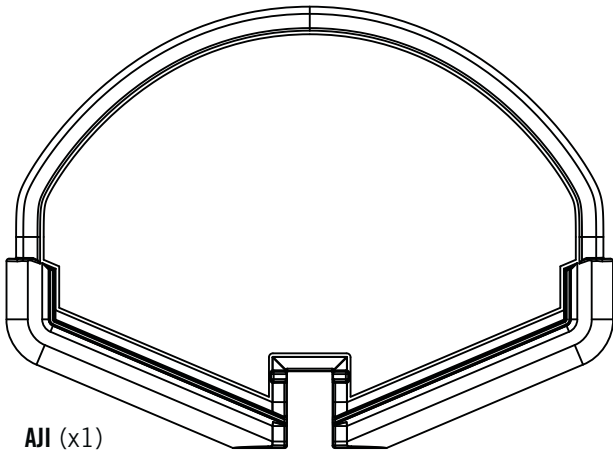

**AJI** (x1)  
Backboard

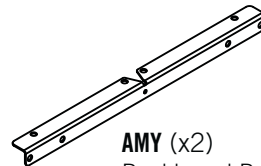

**AMY** (x2)  
Backboard Bracket

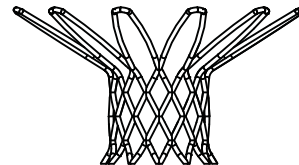

**AKZ** (x1)  
Net

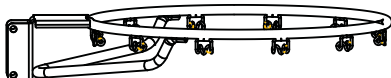

**ALX** (x1)  
Rim

### TOOLS REQUIRED



1/2" Wrench



## TOOLS AND HARDWARE REQUIRED FOR THIS PAGE



1/2"

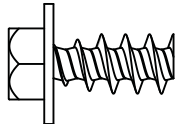

ACV (x6)

SEC 5

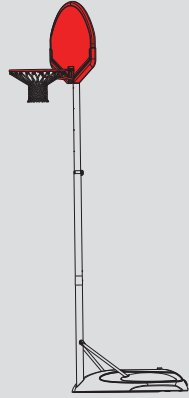

SEC

5.1

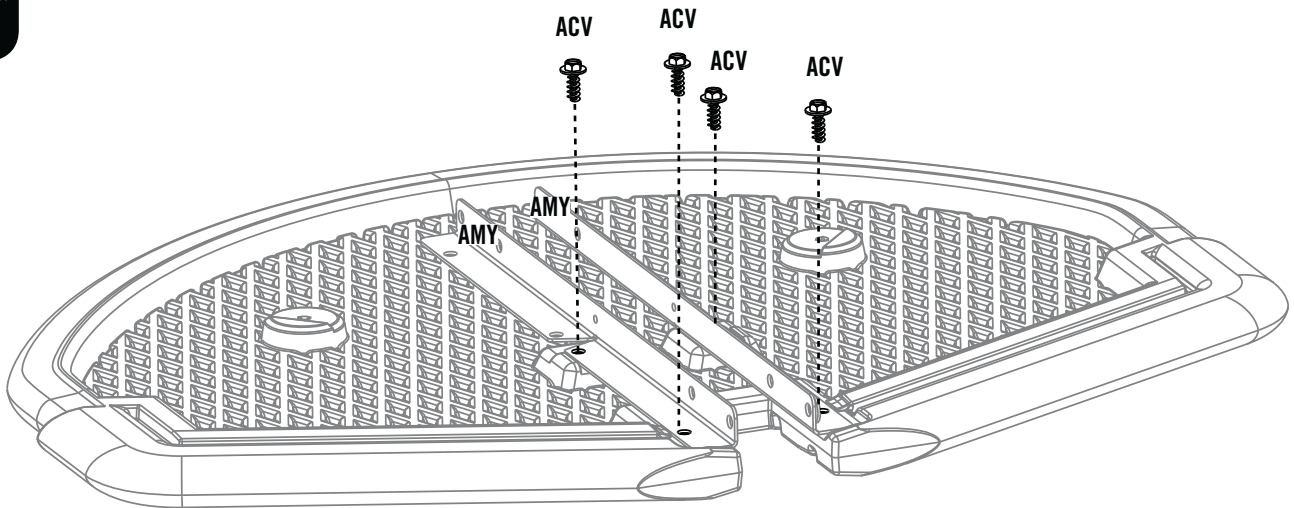

*Note: Do not overtighten the Screws.*

SEC

5.2

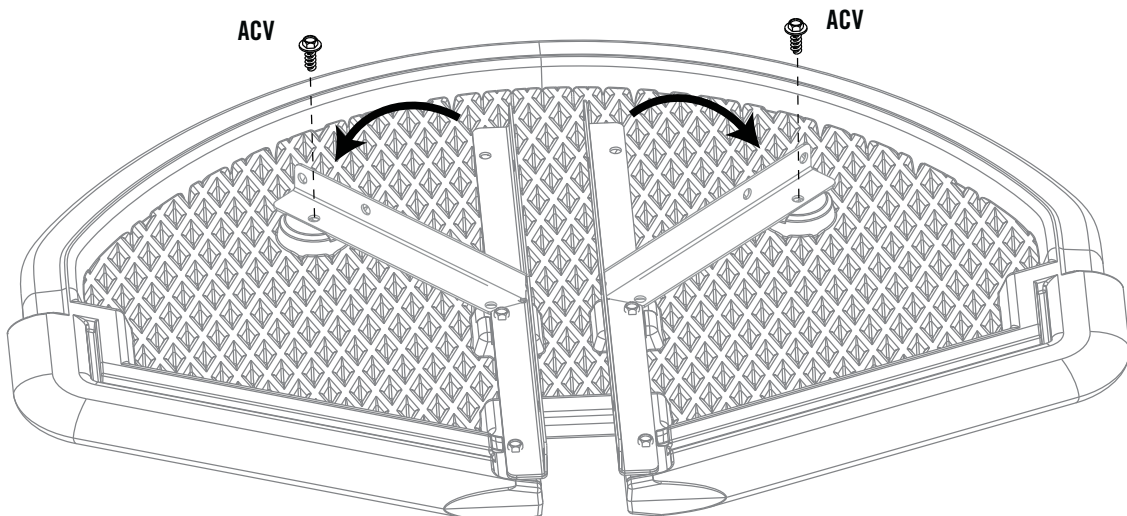



# TOOLS AND HARDWARE REQUIRED FOR THIS PAGE

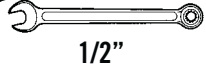

1/2"

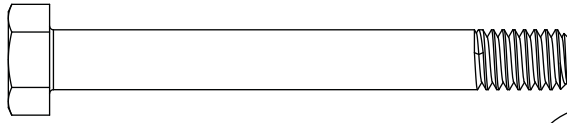

ACM (x2)



AAN (x2)

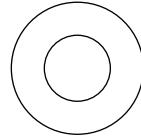

AEC (x4)

SEC 5

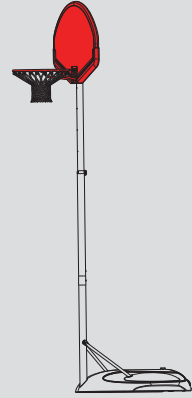

SEC

5.3

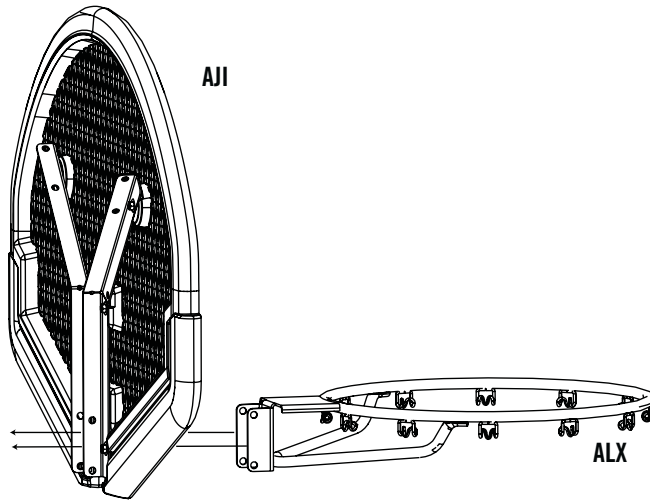

SEC

5.4

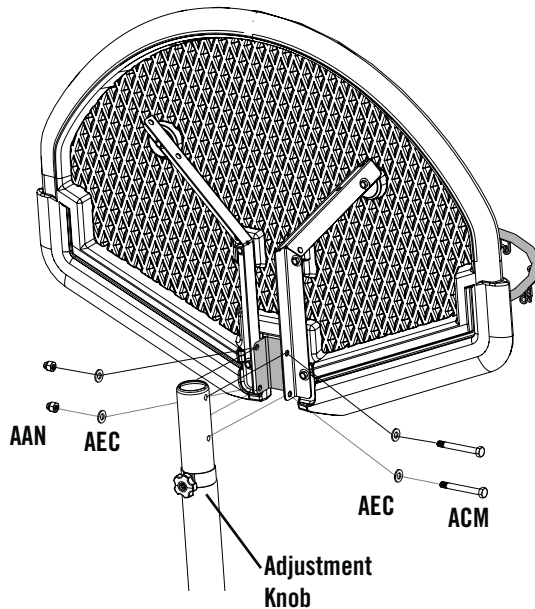

## WARNING

Do not overtighten the Cap Nut. If the end of the Bolt breaks through the plastic cap, call our Customer Service Department. Exposed threads on the end of the Bolt may cause serious injuries.



## TOOLS AND HARDWARE REQUIRED FOR THIS PAGE

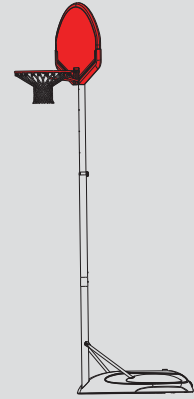

SEC 5

NO TOOLS OR HARDWARE REQUIRED FOR THIS PAGE

SEC  
5.5

Attach **Net (AKZ)** to the **Rim (ALX)**.

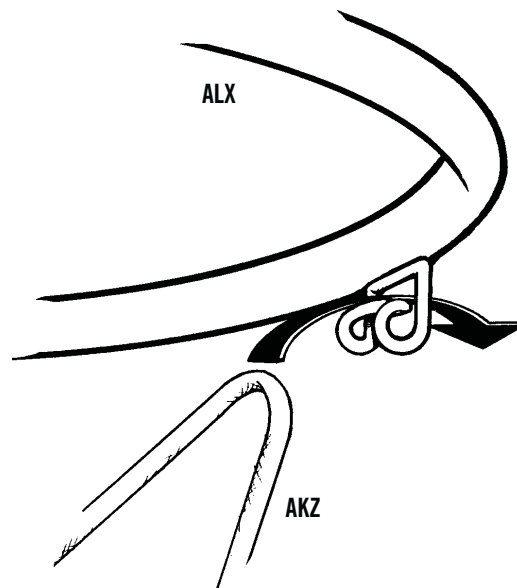

*Note: If a replacement Net is needed, please call our Customer Service Department. Our Nets are shorter than average to reduce the risk of entanglement.*



## OPERATION OF HEIGHT ADJUSTMENT SYSTEM

ONLY ADULTS SHOULD ADJUST THE HEIGHT OF THE SYSTEM.

- a. Adjust the system to its lowest position.
- b. Stand behind the system and pull on the pole until the unit is balanced on its Wheels.
- c. Move the system to the desired location and carefully set the Base down.

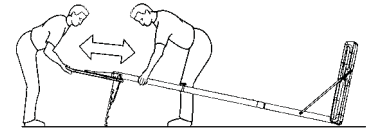

## MOVING THE SYSTEM

**WARNING:** The system must only be moved by people capable of handling its weight. Children should not be allowed to move the system.

- a. Adjust the system to its lowest position, and use caution to prevent the height mechanism from adjusting.
- b. Stand behind the system and pull on the Pole until the unit is balanced on its Wheels.
- c. Move the system to the desired location and carefully set the Base down.

**CAUTION:** The system must only be moved on its Wheels. Sliding the Base may damage the Base which could result in leakage and the system tipping over.

## POLE CARE AND SYSTEM MAINTENANCE

The life of your basketball system depends on many variables. The climate, exposure to corrosives such as salt, pesticides, or herbicides, and excessive use or misuse can all contribute to Pole failure, which may cause property damage or personal injury.

Check your basketball system frequently for loose hardware, excessive wear, and signs of corrosion. For safety reasons, and to prolong the life of your basketball system, you must take the following preventive measures.

- a. Check all Nuts and Bolts. If any are loose, tighten them.
- b. Check all parts for excessive wear and tear. If necessary, replace any parts that have been worn or damaged through usage. Contact our Customer Service Department for replacement parts.
- c. Inspect the Warning Sticker on the Pole. If it is ripped, faded, or illegible, call our Customer Service Department to request a replacement Sticker.
- d. Check all Pole sections for visible rust or chipped or cracked paint. If either are present, do the following:
  1. Use an emery cloth to completely remove any rust or chipped paint.
  2. Clean the area with a damp cloth and allow it to dry.
  3. Apply two coats of a rust preventative, high gloss enamel paint to the area. Allow the paint to dry between coats.

**IF RUST HAS PENETRATED THROUGH THE POLE ANYWHERE, REPLACE IT IMMEDIATELY!**

**ENHANCE YOUR LIFETIME® PURCHASE BY ADDING ACCESSORIES OR OTHER GREAT PRODUCTS:**

---

*To purchase accessories or other Lifetime Products, visit us at:*

***[www.lifetime.com](http://www.lifetime.com)***

***Or call: 1-800-424-3865***

---

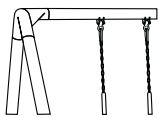



## WARNING



### FAILURE TO FOLLOW THESE WARNINGS MAY RESULT IN SERIOUS INJURY AND/OR PROPERTY DAMAGE.

- Owners must ensure that all players know and follow these rules for safe operation of the system.
- Do not hang from the rim.
  - During play, especially when performing dunk type activities, keep player's face away from the backboard, rim, and net. Serious injury could occur if teeth/face come in contact with the backboard, rim, or net. Player should wear a mouth guard during play.
  - Do not slide, climb, or play on base or pole.
  - Completely fill base according to manufacturer's instructions. Never leave the unit standing in an upright position without first filling the base with weight or the system will tip quickly causing serious personal injury.
  - When adjusting height or moving system, keep hands and fingers away from moving parts.
  - Do not allow children to move or adjust system.
  - Do not wear jewelry (rings, watches, necklaces, etc.) during play. Objects may entangle in net.
  - Keep organic material away from pole base. Grass, litter, etc. could cause corrosion and/or deterioration.
  - Surface beneath the base must be smooth and free of gravel or other objects. Punctures cause leakage and could cause system to tip over.
  - Once a month check pole and all metal parts for signs of corrosion (rust, pitting, chipping). Completely remove rust and repaint with exterior enamel. If rust has penetrated any steel part, replace that part immediately.
  - Check system before each use for proper ballast, loose hardware, excessive wear, instability, and signs of corrosion and repair before use.
  - Never play on damaged equipment.
  - Do not use system during windy or severe weather. System may tip over. Place system in an area protected from the wind or in an area away from property that may be damaged if the system falls, and from overhead power lines.
  - Do not hang anything from the rim or backboard as this will damage the system and void the warranty.



## ADVERTENCIA



## AVERTISSEMENT



### SI NO SE OBEDECEN ESTAS ADVERTENCIAS PUE- DEN PRODUCIRSE GRAVES LESIONES Y/O DAÑOS A LA PROPIEDAD.

- El propietario del sistema debe asegurarse de que todos los jugadores conozcan y respeten estas reglas para que el sistema se use en forma segura.
- No Cuélguese del aro.
  - Durante el juego, especialmente al embocar violentamente de alto, la cara de los jugadores debe mantenerse alejada del tablero, el aro y la red. Pueden producirse lesiones graves si los dientes o la cara entran en contacto con el tablero, el aro o la red. Los jugadores deben usar un protector bucal durante el juego.
  - No se deslice, no trepe ni juegue sobre la base o el poste.
  - Llene la base completamente siguiendo las instrucciones del fabricante. Nunca deje la unidad en posición de uso sin haber llenado previamente la base con material de contrapeso, pues el sistema podría tumbarse rápidamente y causar graves lesiones personales.
  - Mantenga las manos y los dedos alejados de las piezas móviles cuando regule la altura o desplace el sistema.
  - No deje que los niños regulen ni desplacen el sistema.
  - No use joyas (anillos, relojes, collares o gargantillas, etc.) durante el juego. Estos objetos pueden engancharse en la red.
  - La superficie donde se coloque la base debe estar lisa y desprovista de piedras, grava u otros objetos. Las perforaciones pueden originar pérdidas, y éstas pueden hacer que el sistema se tumbe.
  - No permita que la base del poste entre en contacto con materiales orgánicos. El pasto, los desechos animales, etc., pueden causar corrosión y/o deterioros.
  - Controle el poste y todas las piezas metálicas una vez al mes en busca de signos visibles de corrosión (oxidación, picaduras, escamado). Elimine todo rastro de óxido y vuelva a pintar con esmalte para exteriores. Si el óxido ha penetrado cualquier pieza de acero, reemplace esa pieza de inmediato.
  - Inspeccione el sistema antes de cada uso para verificar que esté adecuadamente contrapesado, que los elementos de fijación no estén flojos, que no haya desgaste excesivo, inestabilidad ni signos de corrosión. Si encuentra irregularidades, repárelas antes de usar el sistema. Nunca juegue con un equipo dañado.
  - No use el sistema en presencia de vientos fuertes o condiciones climáticas adversas, ya que puede tumbarse. Coloque la unidad en su posición de almacenamiento y/o en una zona a resguardo del viento, lejos de propiedades personales que puedan dañarse si el sistema se cae, y de líneas de suministro de energía.
  - No cuelgue nada del aro, ni el tablero, ya que esto puede dañar el sistema y anular la garantía.
  - Ne vous suspendez pas à l'anneau.
  - Lors d'un match, particulièrement dans le cas des smashes, le visage du joueur ne doit pas faire face au panneau, à l'anneau, ni au filet. Le joueur risque de graves blessures si ses dents ou son visage entrent en contact avec le panneau, l'anneau, ou le filet. Les joueurs doivent toujours porter un protège-dents lorsqu'ils jouent.
  - Ne glissez pas, ne grimpez pas, et ne jouez pas sur la base ou le poteau.
  - Remplissez complètement la base selon les instructions du fabricant. Ne laissez jamais l'unité debout de plein pied sans avoir d'abord rempli la base avec un poids ou l'équipement pourrait basculer rapidement et causer de graves blessures.
  - Lorsque vous ajustez la hauteur ou lorsque vous déplacez l'équipement, gardez vos mains et doigts loin des pièces mobiles.
  - Ne permettez pas aux enfants de déplacer ou d'ajuster l'équipement.
  - Ne portez pas de bijoux (bagues, montres, colliers, etc.) lorsque vous jouez. Ces objets pourraient s'accrocher au filet.
  - La surface sur laquelle est posée la base doit être lisse et sans gravier ou tout autre objet qui pourrait troubler la base entraînant ainsi une fuite ce qui pourrait faire basculer l'équipement.
  - La base ne doit pas non plus être posée sur aucun type de matière organique. L'herbe, les déchets, etc. peuvent entraîner la corrosion et la détérioration de l'équipement.
  - Une fois par mois, vérifiez que le Poteau et toutes les pièces en métal ne montrent pas de signes de corrosion (rouille, piqûres, écaillage). Enlevez toute la rouille et repeignez complètement avec une peinture pour extérieur. Si la rouille a pénétré une des pièces en acier, vous devrez remplacer immédiatement la pièce en question.
  - A chaque fois que vous allez utiliser l'équipement, vérifiez d'abord l'équilibre, la possibilité de pièces desserrées ou usées, la stabilité de l'équipement et tout signe de corrosion ou réparation nécessaire avant utilisation.
  - Ne jouez jamais avec un équipement endommagé.
  - N'utilisez pas l'équipement lors de fortes rafales de vent ou de mauvais temps. L'équipement pourrait basculer. Placez l'équipement dans un endroit abrité du vent ou loin des structures qu'il pourrait endommager s'il basculait et loin des fils électriques.
  - N'accrochez rien au manche, à l'anneau, ni au panneau sous peine d'endommager l'équipement et d'annuler la garantie.

# 1041050 08/6/2008

# **WARRANTY INFORMATION**

## **LIFETIME BASKETBALL EQUIPMENT**

### **5-YEAR LIMITED FACTORY WARRANTY**

**THE MANUFACTURER RESERVES THE RIGHT TO MAKE SUBSTITUTIONS TO WARRANTY CLAIMS IF PARTS ARE UNAVAILABLE OR OBSOLETE.**

1. Lifetime basketball systems are warranted to the original purchaser to be free from defects in material or workmanship for a period of five years from the date of original retail purchase. The word "defects" is defined as imperfections that impair the use of the product. Defects resulting from misuse, abuse or negligence will void this warranty. This warranty does not cover defects due to improper installation, alteration or accident. This warranty does not cover damage caused by vandalism, rusting, "acts of nature" or any other event beyond the control of the manufacturer.
2. This warranty is nontransferable and is expressly limited to the repair or replacement of defective basketball equipment. If the equipment is defective within the terms of this warranty, Lifetime Products, Inc. will repair or replace defective parts at no cost to the purchaser. Shipping charges to and from the factory are not covered and are the responsibility of the purchaser. Labor charges and related expenses for removal, installation or replacement of the basketball system or its components are not covered under this warranty.
3. This warranty does not cover scratching or scuffing of the product that may result from normal usage. In addition, defects resulting from intentional damage, negligence, unreasonable use or hanging from the net or rim will void this warranty.
4. Liability for incidental or consequential damages is excluded to the extent permitted by law. While every attempt is made to embody the highest degree of safety in all equipment, freedom from injury cannot be guaranteed. The user assumes all risk of injury resulting from the use of this product. All merchandise is sold on this condition, and no representative of the company may waive or change this policy.
5. This product is not intended for institutional or commercial use; Lifetime Products, Inc. does not assume any liability for such use. Institutional or commercial use will void the warranty.
6. This warranty is expressly in lieu of all other warranties, expressed or implied, including warranties of merchantability or fitness for use to extent permitted by Federal and state law. Neither Lifetime Products, Inc., nor any representative assumes any other liability in connection with this product. This warranty gives you specific legal rights, and you may also have other rights which vary from state to state.

**ALL WARRANTY CLAIMS MUST BE ACCOMPANIED BY A SALES RECEIPT.**

**REPORT PRODUCT DEFECTS IN WRITING TO:**

Lifetime Products, Inc., PO Box 160010 Clearfield, UT 84016-0010, or call (800) 225-3865 M-F 7 a.m. to 5 p.m. MST.

**\*\*Call or visit our Web site for Saturday hours\*\***

Please include your dated sales receipt and photographs of damaged parts.

**To register the product, visit our Web site at [www.lifetime.com](http://www.lifetime.com)**



[www.lifetime.com](http://www.lifetime.com)