

LED UTILITY LIGHT INSTALLATION INSTRUCTIONS

WARNING: These products may represent a possible shock or fire hazard if improperly installed or attached in any way. Products should be installed in accordance with the owners manual, current electrical codes and/or the current National Electric Code (NEC).

PARTS INCLUDED

- (1) 4 foot fixture with on/off switch
- (2) mounting screws
- (2) 6 inch hanging cables
- (1) 5 foot plug-in cord

THIS FIXTURE IS INTENDED TO BE ONLY INSTALLED DIRECTLY BENEATH A CEILING-MOUNTED RECEPTACLE.

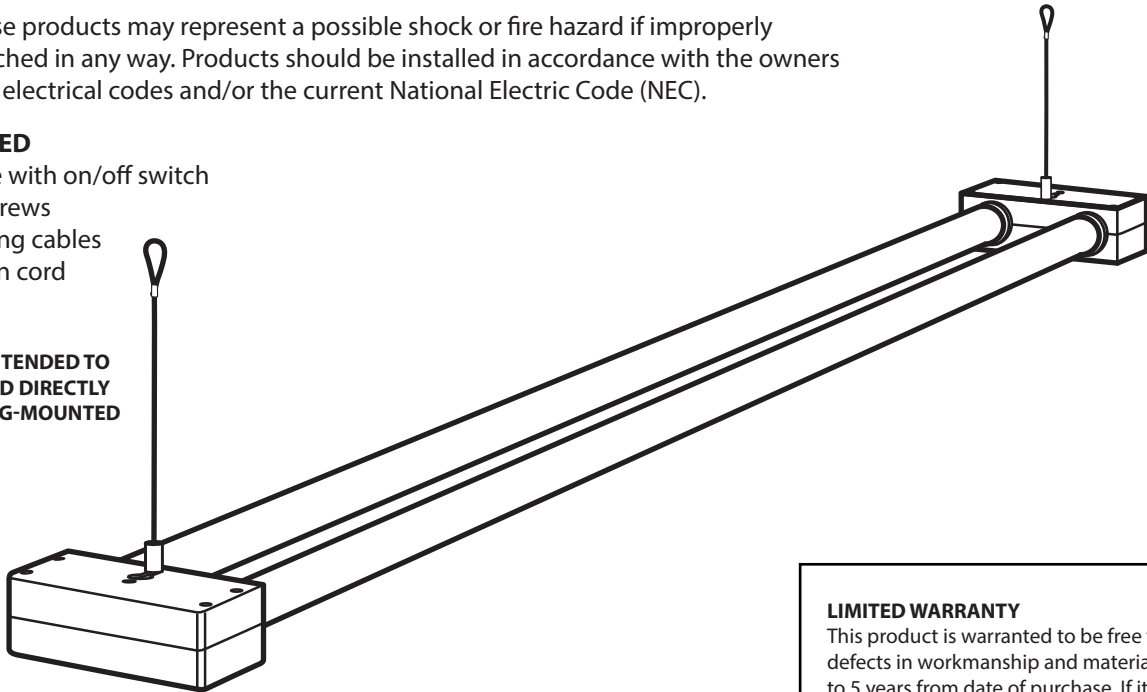

CAUTION, IMPORTANT SAFETY INSTRUCTIONS - This portable light-emitting-diode (LED) luminaire has a polarized plug (One blade is wider than the other) As a feature to reduce the risk of electric shock. This plug will fit in a polarized outlet only one way. If the plug does not fit fully in the outlet, reverse the plug. If it still does not fit, contact a qualified electrician. Never use with an extension cord unless plug can be fully inserted. Do not alter the plug."

LIMITED WARRANTY

This product is warranted to be free from defects in workmanship and materials for up to 5 years from date of purchase. If it fails to do so, please contact Feit Electric at info@feit.com or call 1-866 326-BULB (2852) for instructions on replacement. Do not return the product to the store.

For comments please write to:
 Feit Electric
 Customer Service Department
 4901 Gregg Road, Pico Rivera, CA 90660

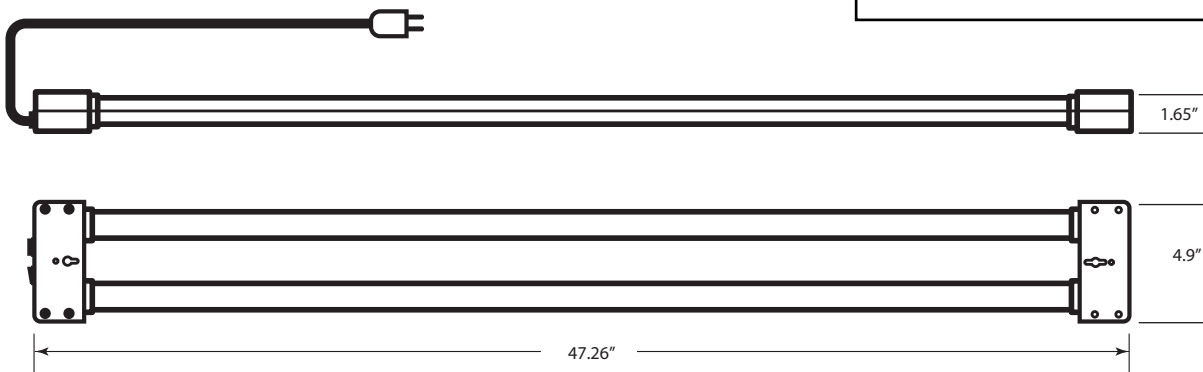

This device complies with part 15 of the FCC Rules. Operation is subject to the following two conditions: (1) This device may not cause harmful interference, and (2) this device must accept any interference received, including interference that may cause undesired operation. Note: This equipment has been tested and found to comply with the limits for a Class B digital device, pursuant to part 15 of the FCC Rules. These limits are designed to provide reasonable protection against harmful interference in a residential installation. This equipment generates, uses and can radiate radio frequency energy and, if not installed and used in accordance with the

instructions, may cause harmful interference to radio communications. However, there is no guarantee that interference will not occur in a particular installation. If this equipment does cause harmful interference to radio or television reception, which can be determined by turning the equipment off and on, the user is encouraged to try to correct the interference by one or more of the following measures: Reorient or relocate the receiving antenna. Increase the separation between the equipment and receiver. Connect the equipment into an outlet on a circuit different from that to which the receiver is connected. Consult the dealer or an experienced radio/TV technician for help.



WARNING: TURN OFF THE MAIN POWER AT THE CIRCUIT BREAKER BEFORE INSTALLING THE FIXTURE IN ORDER TO PREVENT POSSIBLE ELECTRIC SHOCK.

INSTALLATION OPTIONS

Install fixture by using included 6" hanging wire harness (Hooks not included)

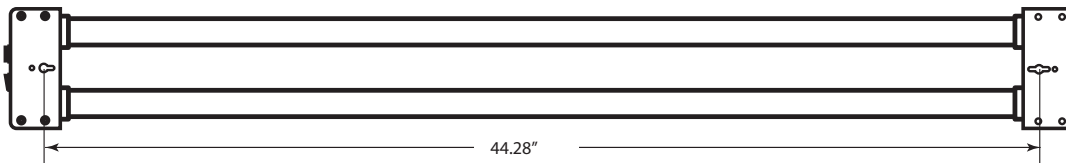
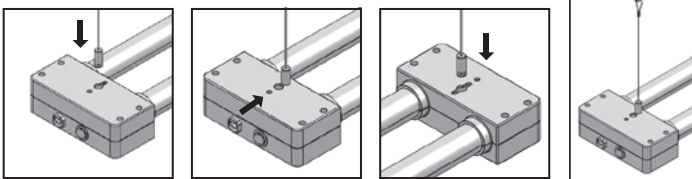

Figure A



1. Attach two hooks to ceiling, spacing between hooks should be 44.28".
2. Install the sliding screw on end-cap (see Figure A).
3. Hang wire harness on the hook.
4. Plug in power cord to outlet.

Install fixture flushmount using screws

1. Install two screws on mounting surface, spacing between screws should be 44.28". Gap (D) should be 0.079~0.099".
2. Lift fixture up to screws and slide to one side to secure into place. Fixture should be firmly fixed against screws.
3. Plug in power cord to outlet.

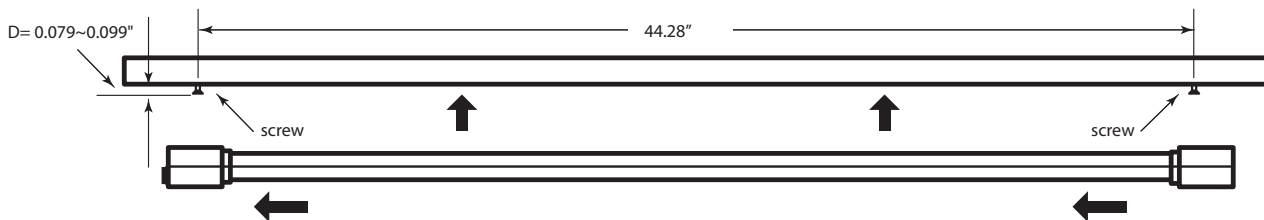

recommended screw dimensions: Head: 6.9~8.7mm, Screw: 4.0~4.2mm.

Install fixture using any length chain and S-hooks (Chain and S-hooks not included)

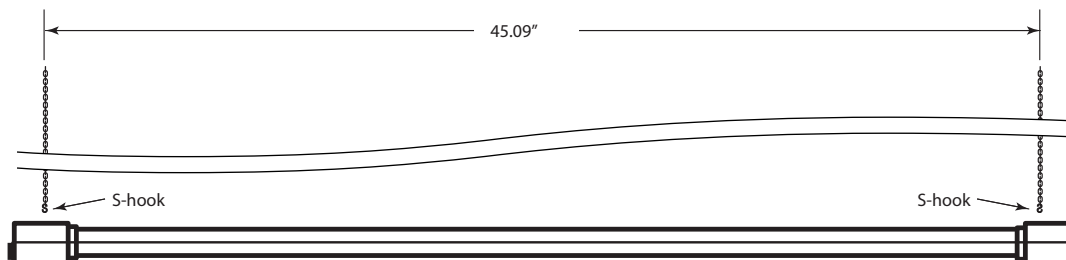
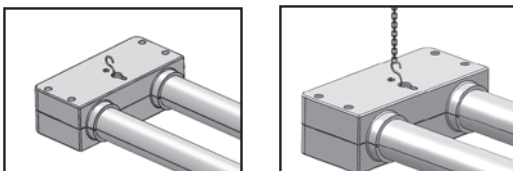

Figure B



1. Install the chain on the ceiling, spacing between suspension lines should be 45.09".
2. Use S-hook (1/8" x 1-1/4" recommended) to hang the key hole of end-cap, and hang the S-hook on chain (see Figure B).
3. Plug in power cord to outlet.