

Item #1000 288 829
 Item #1002 954 696
 Item #1002 954 693
 Item #1002 954 701

Model #PPSPAWHT24M
 Model #PPSPAWHT30M
 Model #PPSPADVR24M
 Model #PPSPADVR30M

Use and Care Guide Vanity Combo

TOOLS REQUIRED

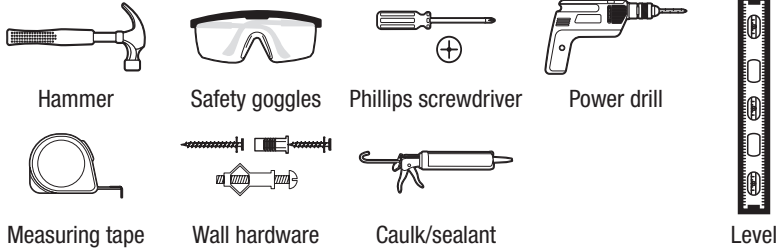

HARDWARE INCLUDED

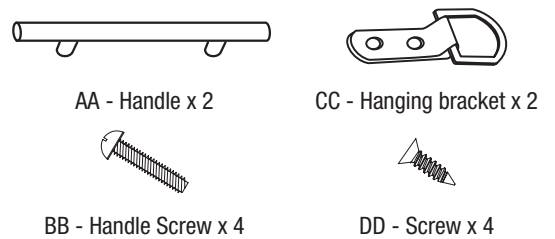

Installation

1 PREPARING FOR INSTALLATION



NOTE: Before installation, make sure all parts are present. Compare parts with the Hardware Included list. If any part is missing or damaged, do not attempt to install the product.

- Determine the desired mounting location, and mark the wall where the unit will be installed.



NOTE: For secure installation, the unit must be mounted to at least one wall stud.

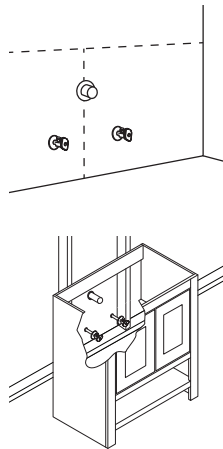

2 POSITIONING THE CABINET

- Move the cabinet into place, and use wood shims to level the cabinet against the wall.

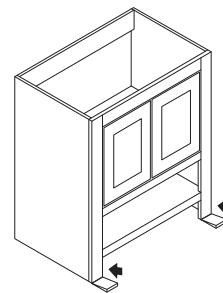

3 INSTALLING THE CABINET

- For wall stud installation, insert #12 x 3 in. screws with washers into the stud locations (not included).
- For drywall installation, drill holes at the appropriate locations and insert toggle bolts with washers (not included).
- For concrete wall installation, drill 1/4 in. holes at the appropriate locations and insert #12 wall anchors, followed by #12 x 3 in. screws (not included).

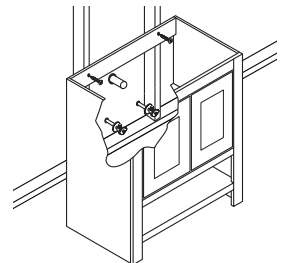
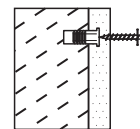
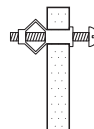
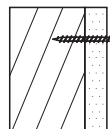

4 INSTALLING THE VANITY TOP



IMPORTANT: Do not use plumber's putty.



NOTE: The faucet, drain, and supply lines are not included. Install these parts to the vanity top according to the manufacturer's instructions.

- Apply silicone caulk/sealant (not included) to all four corners of the cabinet.
- Place the vanity top onto the cabinet.
- Position the top so that it has an equal amount of overhang on each side and use a level to ensure the vanity top surface is level.
- Apply silicone onto the seam between the edge of the vanity top and the wall, smooth the bead, and allow to cure before use.

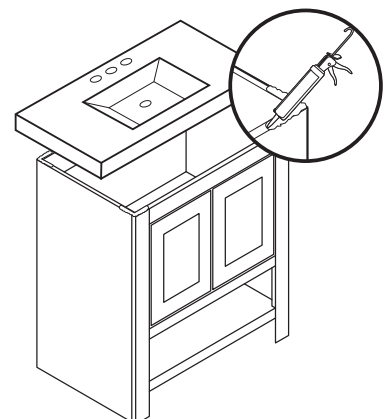

5 INSTALLING THE HARDWARE

- Attach the handles (AA) to the cabinet with the provided screws (BB).

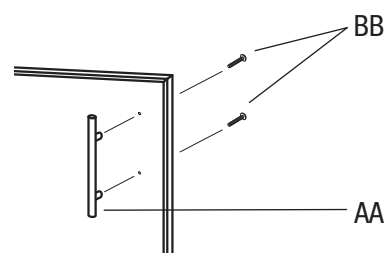

Installation (continued)

6 INSTALLING THE HANGING BRACKETS



NOTE: Before installing, make sure all parts are present. Compare parts with the Hardware Included list. If any part is missing or damaged, do not attempt to install the product.

- Attach the hanging brackets (CC) to the back of the mirror using the included screws (DD).

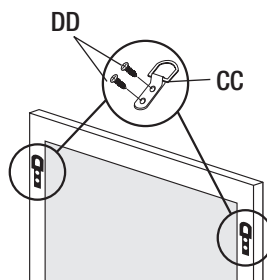

7 INSTALLING THE HANGING WIRE



NOTE: This step is optional, and the hanging hardware is not included.

- If you choose to use hanging wire (not included) attach it to brackets as shown below.

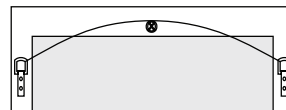

8 INSTALLING THE MIRROR

- For wall stud installation, insert #12 x 3 in. screws with washers into the stud locations (not included).
- For drywall installation, drill holes at the appropriate locations and insert toggle bolts with washers (not included).
- For concrete wall installation, drill 1/4 in. holes at the appropriate locations and insert #12 wall anchors, followed by #12 x 3 in. screws (not included).

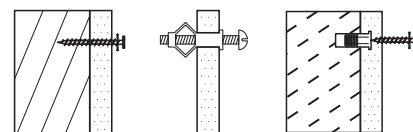

Troubleshooting

Problem	Possible Cause	Solution
The doors do not align or the space is too big or too tight between the doors.	The hinges are misaligned.	Hold the door while loosening screws. Align the doors properly, and re-tighten the screws.

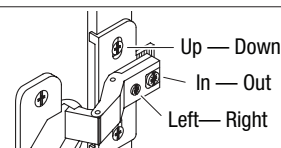

Safety Information

Please read and understand this entire manual before attempting to assemble, operate or install the product.

Care and Cleaning

- Use a water-dampened cloth to clean the cabinet. Avoid using abrasive cleaners.
- Use a mild liquid soap and a soft cloth to clean your vanity top. Avoid using any harsh, abrasive cleaners or mineral spirits.

Warranty

LIMITED 5-YEAR WARRANTY

WHAT IS COVERED

The manufacturer warrants its parts and products to be free of substantial defects in materials and workmanship from the original date of purchase under normal home use. This warranty is offered only to the original consumer purchaser and may not be transferred.

Coverage for vanity combos lasts for five years from the original date of purchase.

During the warranty period, the manufacturer, at its option, will repair or replace any part or product that proves to have substantial defects in materials or workmanship, or the manufacturer will provide an equivalent replacement product. In keeping with our policy of continuous product improvement, the manufacturer reserves the right to change specifications in design and materials without notice and with no obligation to retrofit products we previously manufactured.

This warranty gives you specific legal rights, and you may also have other rights that vary from state to state.

Because of the varying natural characteristics of wood and the effects of aging, product shown in displays and/or printed materials will not be an exact match to new cabinetry you will receive. Depending on the wood characteristics, the age of a sample and the environment of the showroom, samples will show some degree of variation from new product. In addition, you should not expect all doors, drawer fronts, trim or molding to match exactly in either finish or grain. Variation in wood is normal and unavoidable. In addition, it is not possible to exactly match our colors in printed materials. Therefore, you should view the actual samples when making your color selection.

WHAT IS NOT COVERED

This warranty does not cover any problems or damage which result from improper transportation, improper installation, mishandling, misuse, abuse, neglect, abnormal use, commercial use, improper maintenance, non-manufactured repairs, accidents, or acts of God, such as hurricanes, fire, earthquakes or floods. This warranty and any applicable implied warranties do not cover incidental or consequential damages arising from any defects in the product, such as labor charges for installation or removal of the product or any associated products. This warranty does not cover defects or damage caused by normal wear & tear, alterations, environmental conditions, humidity absorption, or mold. In addition, variations in wood grain, finish color, aging or other natural wood and stain characteristics are not considered defects and are not covered by this warranty. Some states do not allow the exclusion or limitation of incidental or consequential damages, so the above limitation or exclusion may not apply to you.

THE MANUFACTURER DISCLAIMS ANY IMPLIED WARRANTY OF MERCHANTABILITY, AND THERE ARE NO WARRANTIES THAT EXTEND BEYOND THE DESCRIPTIONS ON THE FACE HEREOF. TO THE EXTENT THAT SUCH DISCLAIMER IS NOT VALID UNDER APPLICABLE LAW, ANY IMPLIED WARRANTY SHALL BE COEXTENSIVE IN DURATION WITH THIS WARRANTY.

Products should be examined for defects prior to installation. This warranty does not cover labor charges for installation or removal of the product or any associated products. If upon inspection you find our product has a damaged or missing part, it may not be necessary to return the unit to the store of purchase. Please contact customer service to obtain a replacement part.

If you need replacement parts or would like to make a warranty claim, please contact customer service at 1-888-774-8062. All warranty claims must include the model number of the product, copy of the original receipt and the nature of the problem. In addition, the manufacturer may at its discretion require inspection of the installation site or authorize the prepaid return of the claimed defective part. Merchandise not pre-approved for return will not be accepted and the associated claim not accepted.

IMPORTANT HEALTH NOTICE

Some of the building materials used in this home (or these building materials) emit formaldehyde. Eye, nose, and throat irritation, headache, nausea and a variety of asthma-like symptoms, including shortness of breath, have been reported as a result of formaldehyde exposure. Elderly persons and young children, as well as anyone with a history of asthma, allergies, or lung problems, may be at greater risk. Research is continuing on the possible long-term effects of exposure to formaldehyde.

Reduced ventilation may allow formaldehyde and other contaminants to accumulate in the indoor air. High indoor temperatures and humidity raise formaldehyde levels. When a home is to be located in areas subject to extreme summer temperatures, an air-conditioning system can be used to control indoor temperature levels. Other means of controlled mechanical ventilation can be used to reduce levels of formaldehyde and other indoor air contaminants.

If you have any questions regarding the health effects of formaldehyde, consult your doctor or local health department.