



## 7' x 7' STORAGE BUILDING Assembly Instructions

COBERTIZO DE ALMACENAMIENTO DE 213 cm x 213 cm  
Instrucciones de armado

ABRI DE RANGEMENT 213 cm x 213 cm  
Instructions d'assemblage

1Q08

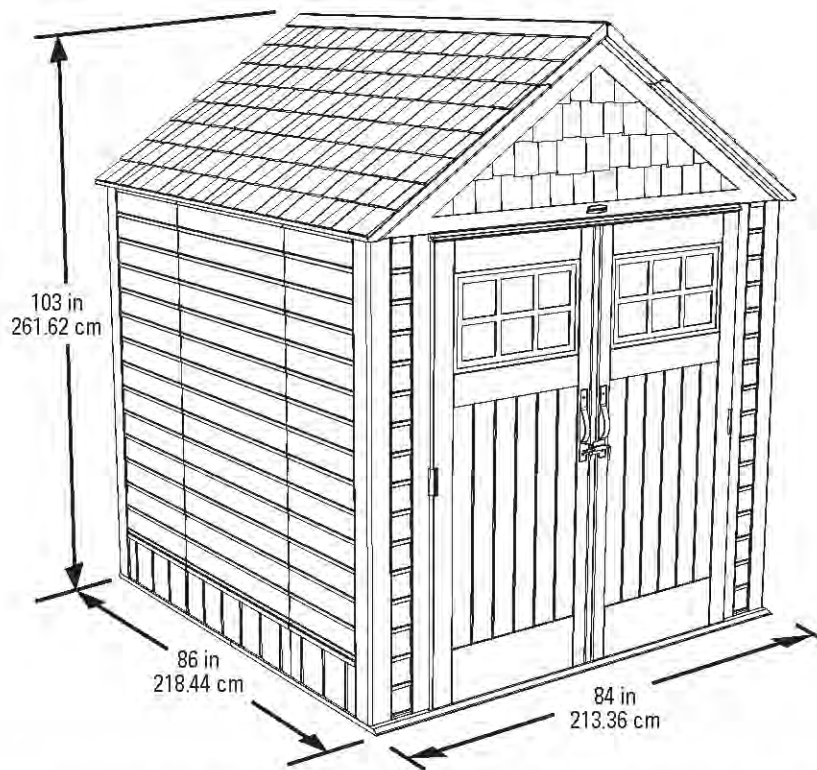

Thank you for purchasing this Rubbermaid® storage building. This dependable product was designed to look great outdoors and keep your yard organized. We want your experience to be a good one. Please read these instructions thoroughly before assembling the storage building.

Gracias por adquirir este cobertizo de almacenamiento Rubbermaid®. Este producto confiable ha sido diseñado para verse bien al aire libre y mantener su patio organizado. Queremos que tenga una buena experiencia. Por favor lea atentamente estas instrucciones antes de ensamblar el cobertizo de almacenamiento.

Merci d'avoir acheté cet abri de rangement Rubbermaid®. Ce produit fiable a été conçu pour avoir une belle apparence à l'extérieur et vous aider à garder votre cour en ordre. Nous souhaitons que votre expérience soit agréable. Veuillez lire attentivement ces instructions avant de construire l'abri.

## Before you begin

1. Building Codes – Check your local building codes, ordinances and restrictions and applicable neighborhood governances.
2. **Surface Preparation – To ensure proper assembly and performance, your storage building needs to be built on a solid, level surface. A concrete slab or treated-wood platform is recommended.**
3. Location – When choosing a location in your yard, make sure you choose an area with easy access and one that provides proper drainage for water to run away from the storage building location.
4. Preassembly – Review ALL assembly steps before beginning construction. Follow all cautions and warnings carefully.
5. Preassembly – Review the parts list and make sure that no parts are missing.

## If you need help

If assistance is needed, **do not contact or return to the store**. Call our Consumer Service Department at 1-888-895-2110 (Mon.–Fri. 8:30 a.m. to 5:00 p.m. EST). Keep this instruction booklet and your original store receipt to ensure our Consumer Service Department can accurately and quickly assist you.

**Rubbermaid® Consumer Service Department  
1-888-895-2110**

[www.Rubbermaid.com](http://www.Rubbermaid.com)

## Warnings, Use & Care

- Always wear gloves when handling metal components
- Always use eye protection/safety glasses during assembly.

 When installing screws, do not overtighten.

## Antes de comenzar

1. Códigos de construcción: revise las restricciones, las ordenanzas y los códigos de construcción locales así como también las disposiciones del vecindario correspondientes.
2. **Preparación de la superficie – Para asegurar un ensamble adecuado y buenos resultados, su cobertizo debe ser instalado sobre una superficie sólida, nivelada. Una superficie de cemento o madera tratada.**
3. Locación – Cuando elija la ubicación en su patio asegúrese de elegir un área con fácil acceso y que tenga buen drenaje de agua.
4. Prearmado: revise TODOS los pasos para el armado antes de comenzar. Siga atentamente todas las precauciones y las advertencias.
5. Prearmado: revise la lista de piezas y asegúrese de que no haya piezas faltantes.

## Si necesita ayuda

Si necesita asistencia, **no llame a la tienda ni devuelva el producto**. Llame a nuestro Departamento de Atención al Cliente al 1-888-895-2110 (de lunes a viernes, de 8:30 a.m. a 5:00 p.m. EST). Guarde este manual de instrucciones y la factura original de su tienda para garantizar que nuestro Departamento de Atención al Cliente pueda ayudarlo rápida y correctamente.

**Rubbermaid® Consumer Service Department  
1-888-895-2110**

[www.Rubbermaid.com](http://www.Rubbermaid.com)

## Advertencias, uso y mantenimiento

- Siempre use guantes al manipular los componentes metálicos.
- Siempre utilice protección para los ojos/gafas de seguridad durante el armado.

 No ajuste los tornillos en exceso.

## Avant de commencer

1. Codes du bâtiment – Vérifiez les codes du bâtiment locaux, les ordonnances et restrictions et les règlements de quartier applicables.
2. Préparation de la surface – Pour assurer un bon assemblage et une utilisation optimale votre abri de rangement doit être construit sur une surface solide et plane. Une dalle en béton, un patio ou une plate-forme en bois traité est recommandée.
3. Emplacement – Lorsque vous déterminez l'emplacement de l'abri dans votre jardin, assurez-vous de choisir une zone facile d'accès et avec une bonne évacuation de l'eau.
4. Préassemblage – Lisez attentivement TOUTES les étapes avant de commencer l'assemblage. Suivez attentivement toutes les précautions et mises en garde.
5. Préassemblage – Examinez la liste des pièces et assurez-vous qu'il n'en manque aucune.

## Si vous avez besoin d'aide

Si vous avez besoin d'aide, **ne communiquez pas avec le magasin et ne retournez pas le produit**. Appelez notre service aux consommateurs au 1-888-895-2110 (lun. au ven. de 8 h 30 à 17 h HNE). Veuillez garder le présent livret d'instructions et le reçu du magasin afin que notre service aux consommateurs puisse vous aider adéquatement.

**Rubbermaid® Consumer Service Department  
1-888-895-2110**

[www.Rubbermaid.com](http://www.Rubbermaid.com)

## Mises en garde, utilisation et entretien

- Toujours porter des gants lors de la manutention de composants en métal.
- Utilisez toujours une protection des yeux/lunettes de protection pendant l'assemblage.

 Ne serrez pas trop les boulons lorsque vous les installez.



Safety Glasses

Gafas de seguridad

Lunettes de sécurité



Gloves

Guantes

Gants



Phillips Screwdriver

Destornillador de cabeza Phillips

Tournevis Phillips



Drill

Taladro

Perceuse



Magnetic Phillips Bit #2 and #3

Cabezas magnéticas Phillips n.º 2 y 3

Mèche cruciforme magnétique n.º 2 et 3



7/16" Combination Wrench

Llave combinada 7/16"

Clé mixte 7/16 po

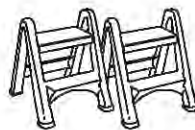

(2) Step Stools

Taburetes

Tabourets-escabeaux



7/16" Ratchet Wrench

Llave de torque 7/16"

Clé à cliquet 7/16 po

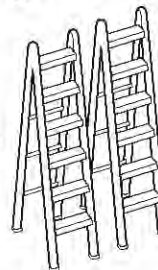

(2) 6 Foot Stepladders

(2) Escaleras de 6 escalones

(2) Escabeaux 6 pi



**DO NOT** overtighten screws!

¡NO ajuste los tornillos en exceso!

**ÉVITEZ** de trop serrer les boulons!



**A - 1**

Left Front Corner  
Esquina frontal izquierda  
Coin avant gauche



**B - 1**

Left Side  
Lado izquierdo  
Côté gauche



**C - 1**

Left Back Corner  
Esquina trasera izquierda  
Coin arrière gauche

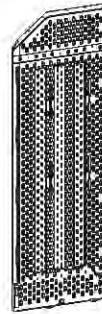

**D - 1**

Left Back  
Dorso izquierdo  
Arrière gauche



**E - 1**

Right Front Corner  
Esquina frontal derecha  
Coin avant droit



**F - 1**

Right Side  
Lado derecho  
Côté droit



**G - 1**

Right Back Corner  
Esquina trasera derecha  
Coin arrière droit



**H - 1**

Right Back  
Dorso derecho  
Arrière droit



**J - 1**

Front Floor  
Piso frontal  
Plancher avant

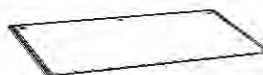

**K - 1**

Back Floor  
Piso trasero  
Plancher arrière

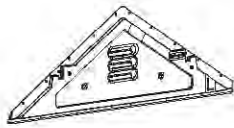

**L - 1**

Rear Gable  
Gablete posterior  
Pignon arrière

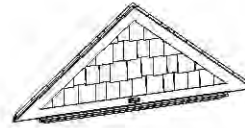

**M - 1**

Front Gable  
Techo frontal  
Pignon avant



**N - 1**

Left Door  
Puerta izquierda  
Porte gauche



**P - 1**

Right Door  
Puerta derecha  
Porte droite



**Q - 2**

Lower Roof  
Tejado inferior  
Toit inférieur



**R - 1**

Upper Roof  
Tejado superior  
Toit supérieur



**TL - 1**

Left Door Handle  
Manija de la puerta  
Poignée

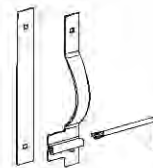

**TR - 1**

Right Door Handle  
Manija de la puerta  
Poignée

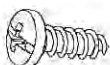

**AA - 140**

#14 x .75 Screws  
#14 x .75 Tornillos  
#14 x .75 Vis

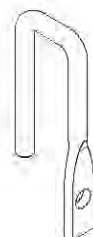

**AB - 12**

Accessory Bracket  
Ménsula accesoria  
Accessoire de fixation



**BB - 26**

#8 x .50 Flat Head Phillips  
Self Tapping Screws

Tornillos autorroscantes Phillips  
de cabeza chata #8 x .50

Vis autotaraudeuses  
Phillips à tête plate N°  
8 x 0,50

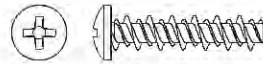

**CC - 42**

#8 x .75 Pan Head Phillips  
Self Tapping Screws

Tornillos autorroscantes Phillips  
de cabeza redonda #8 x .75

Vis autotaraudeuses  
Phillips à tête cylindrique  
N° 8 x 0,75



**CT - 1**

Collar Tie

Abrazadera para tirante

Entrait retroussé



**CTB - 4**

Collar Tie Bracket

Ménsula de abrazadera  
para tirante

Fixation pour entrait  
retroussé

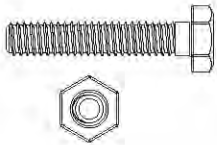

**DD - 6**

1/4\"-20 x 1.375 Hex Bolt

Tornillo hexagonal de  
1/4\"-20 x 1.375

Boulon hexagonal  
1/4 po- 20 x 1,375



**DR - 2**

Door Reinforcement

Refuerzo de puerta

Renfort de porte

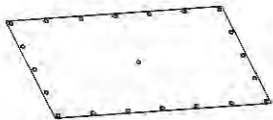

**DW - 2**

Door Window

Puerta ventana

Vitre de porte

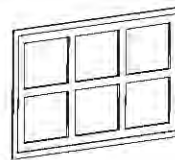

**DWF - 2**

Door Window Frame

Marco para puerta ventana

Encadrement de vitre  
de porte

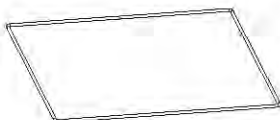

**DWG - 2**

Door Window Gasket

Junta para puerta ventana

Joint de vitre de porte

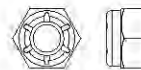

**EE - 6**

1/4\"-20 Hex Nylon Lock Nut

Contratuera hexagonal  
de nylon de 1/4\"-20

Contre-écrou hexagonal  
à garniture de nylon  
1/4 po - 20

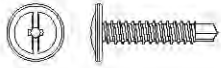

**FF - 12**

#8 x .75 Truss Washer  
Self Drilling Screws  
Arandela de celosía #8 x .75  
tornillos auto perforantes  
Vis cruciforme N° 8 x 0,75  
vis autoperceuses



**GG - 4**

1/4" SAE Flat Washer  
Arandela plana SAE 1/4"  
Rondelle plate SAE 1/4 po



**HB - 2**

Door Middle Hinge  
Bisagra de puerta central  
Charnière milieu de porte



**HD - 2**

Header  
Cabecera  
Linteau



**JJ - 42**

#8 Neoprene Washer  
Arandela de neopreno #8  
Rondelle en néoprène N° 8



**KK - 4**

Carriage Bolt  
Perno de cuello cuadrado de  
cabeza redonda  
Boulon à tête carrée à  
tête ronde



**RPN - 8**

Roof Pin  
Pasador para  
el techo  
Barrette de toit



**RPR - 2**

Roof Purlin  
Travesaño  
Panne de charpente

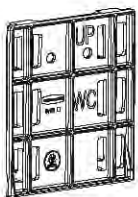

**WC - 29**

Wall Connector  
Conector de pared  
Connecteur mural

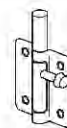

**HH - 2**

Barrel Bolt  
Cerrojo pasado  
Pêne rond

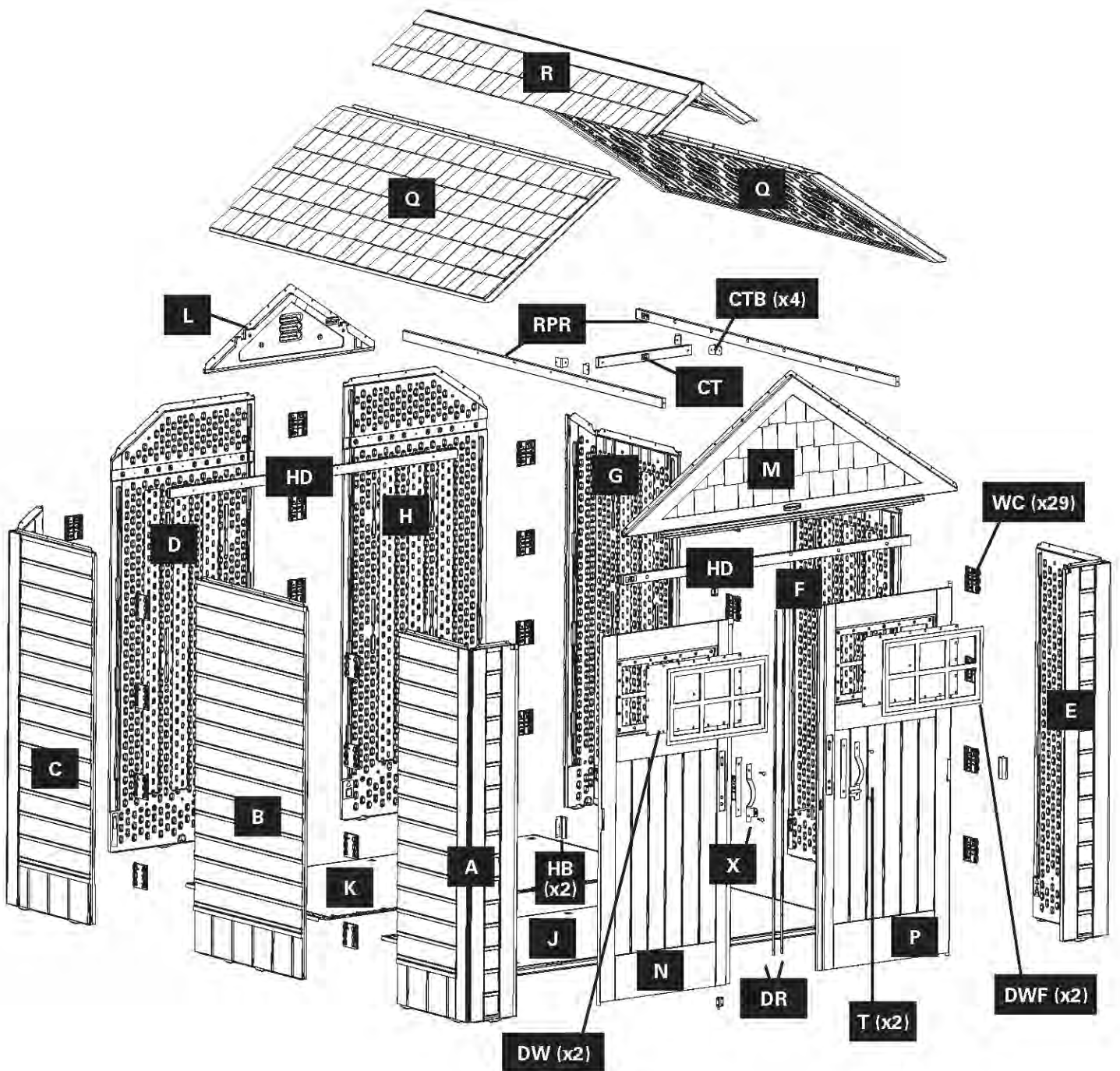



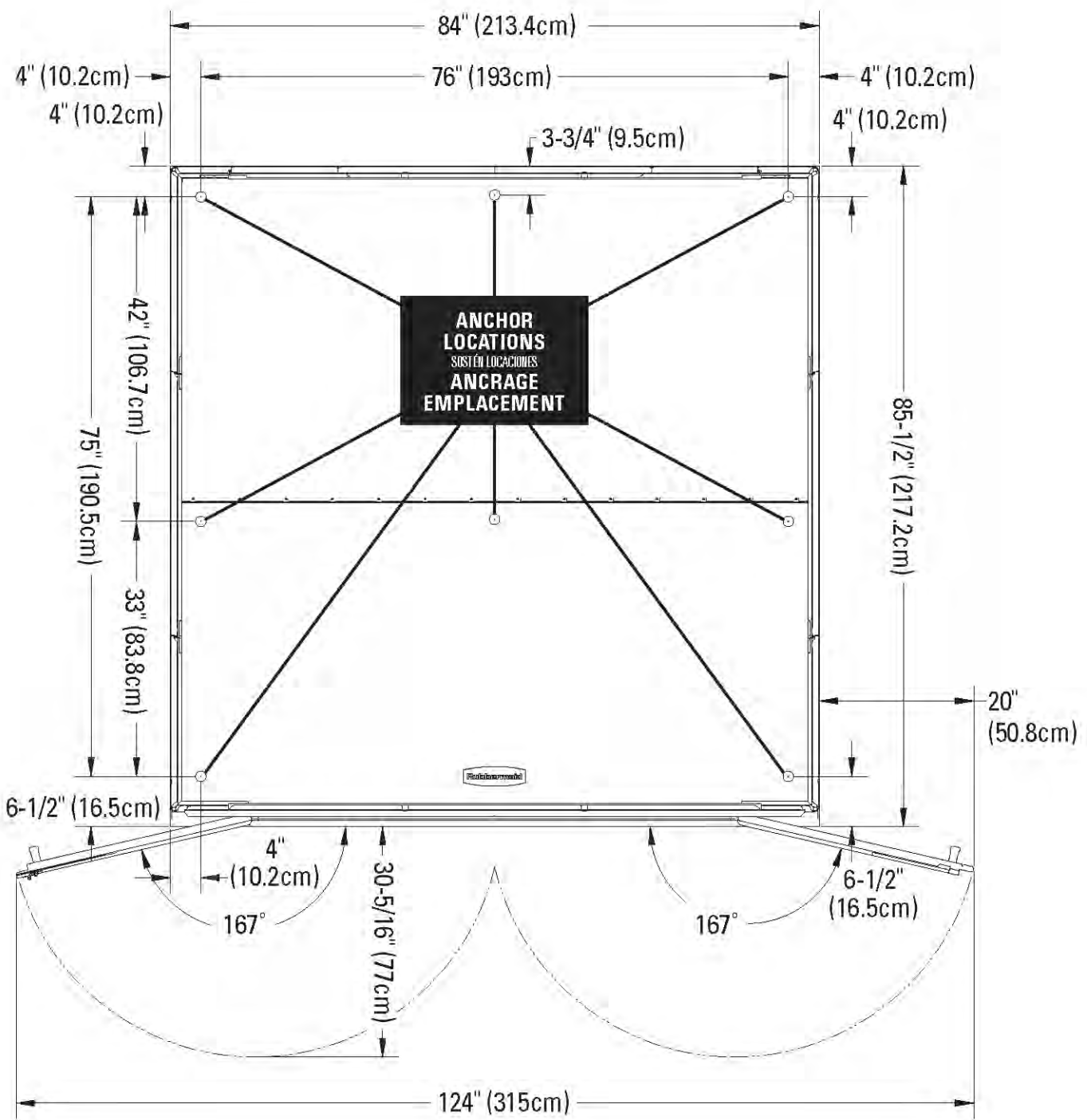
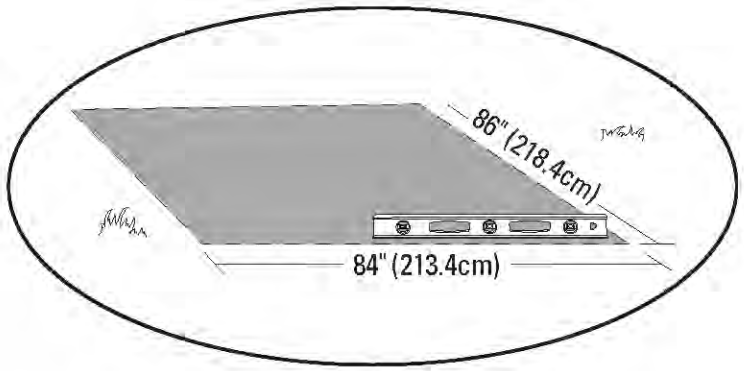
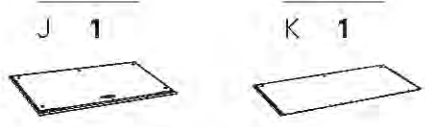

1



2

	AA	14
	J	1
	K	1



**DO NOT**  
overtighten screws!  
(NO ajuste los tornillos en exceso!  
**ÉVITEZ**  
de trop serrer les boulons!

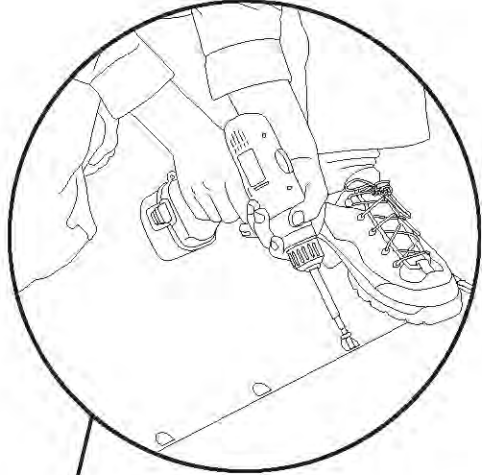

AA x 14

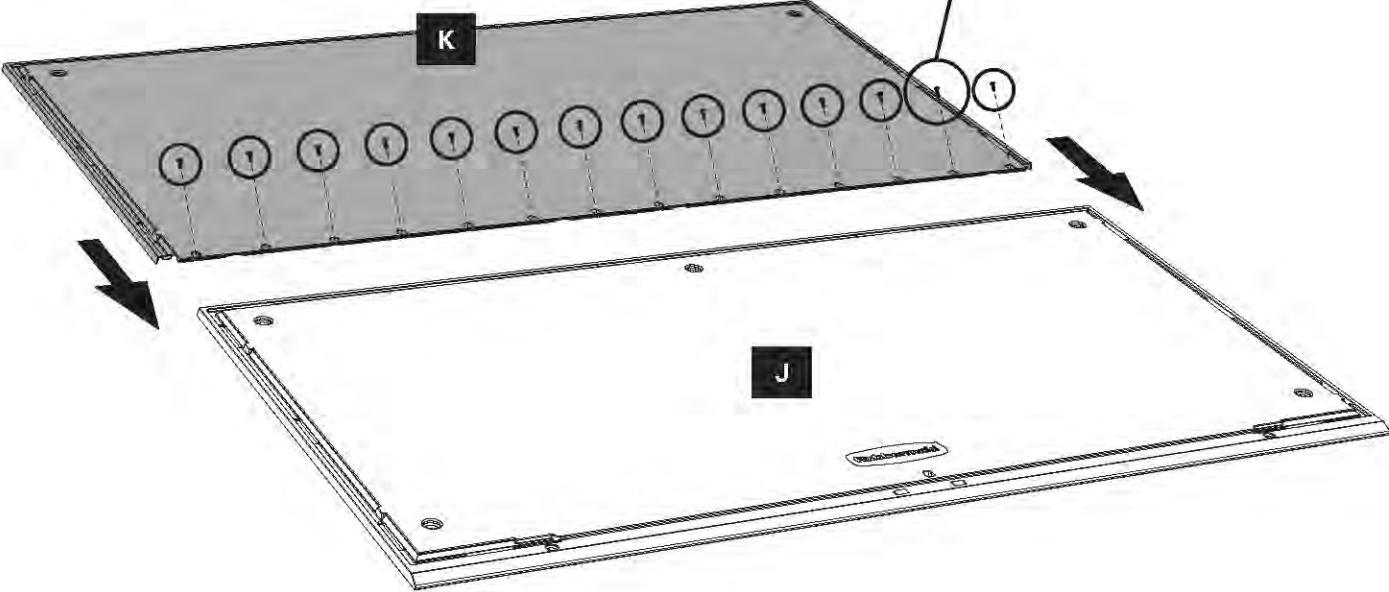

**3a**

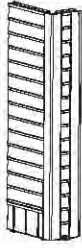

A 1

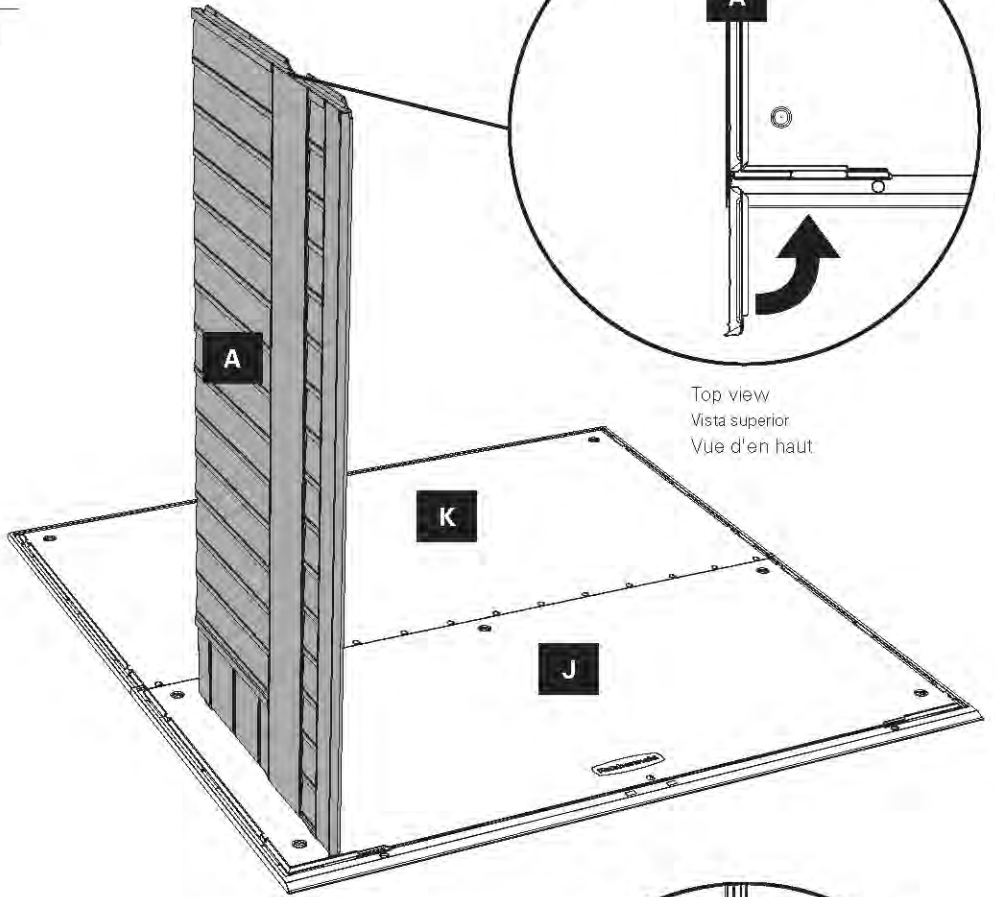

Top view  
Vista superior  
Vue d'en haut

**3b**

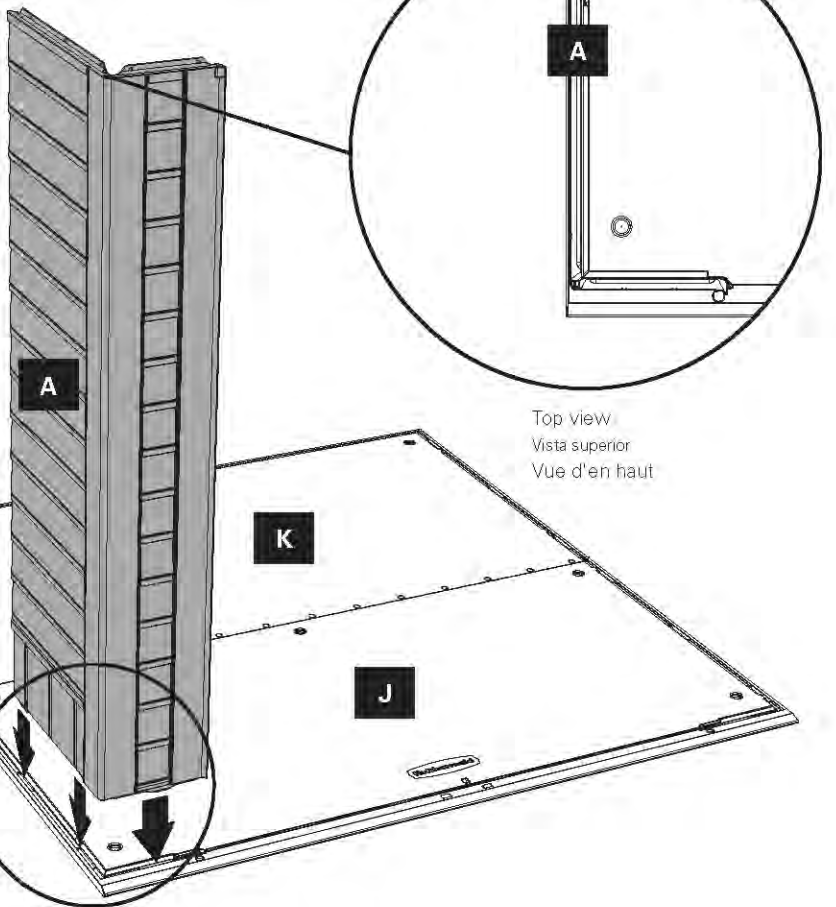
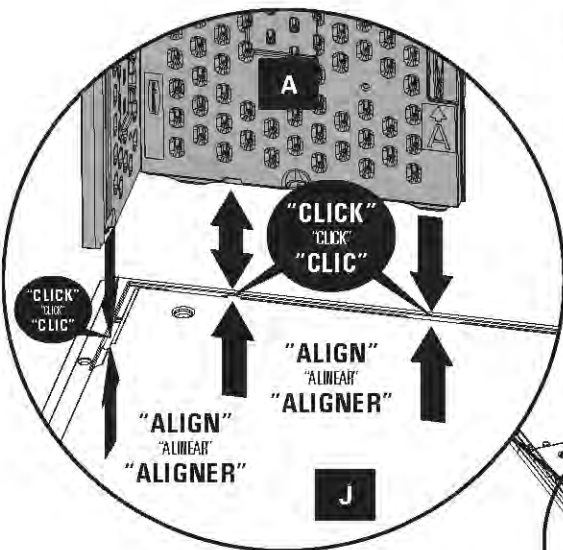

Top view  
Vista superior  
Vue d'en haut

**4a**

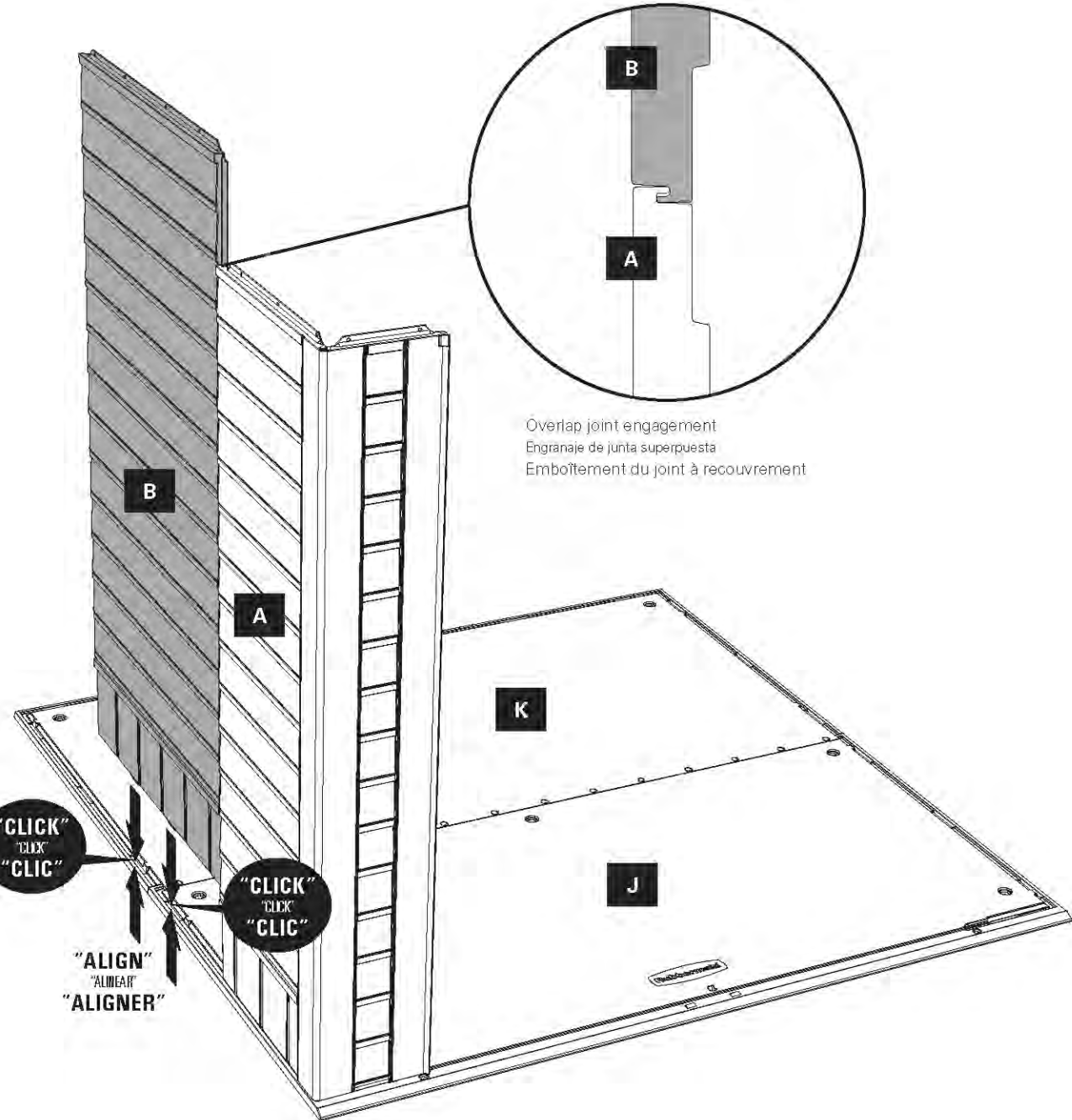
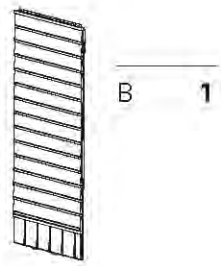

Overlap joint engagement  
Engranaje de junta superpuesta  
Emboîtement du joint à recouvrement

4b



WC 4

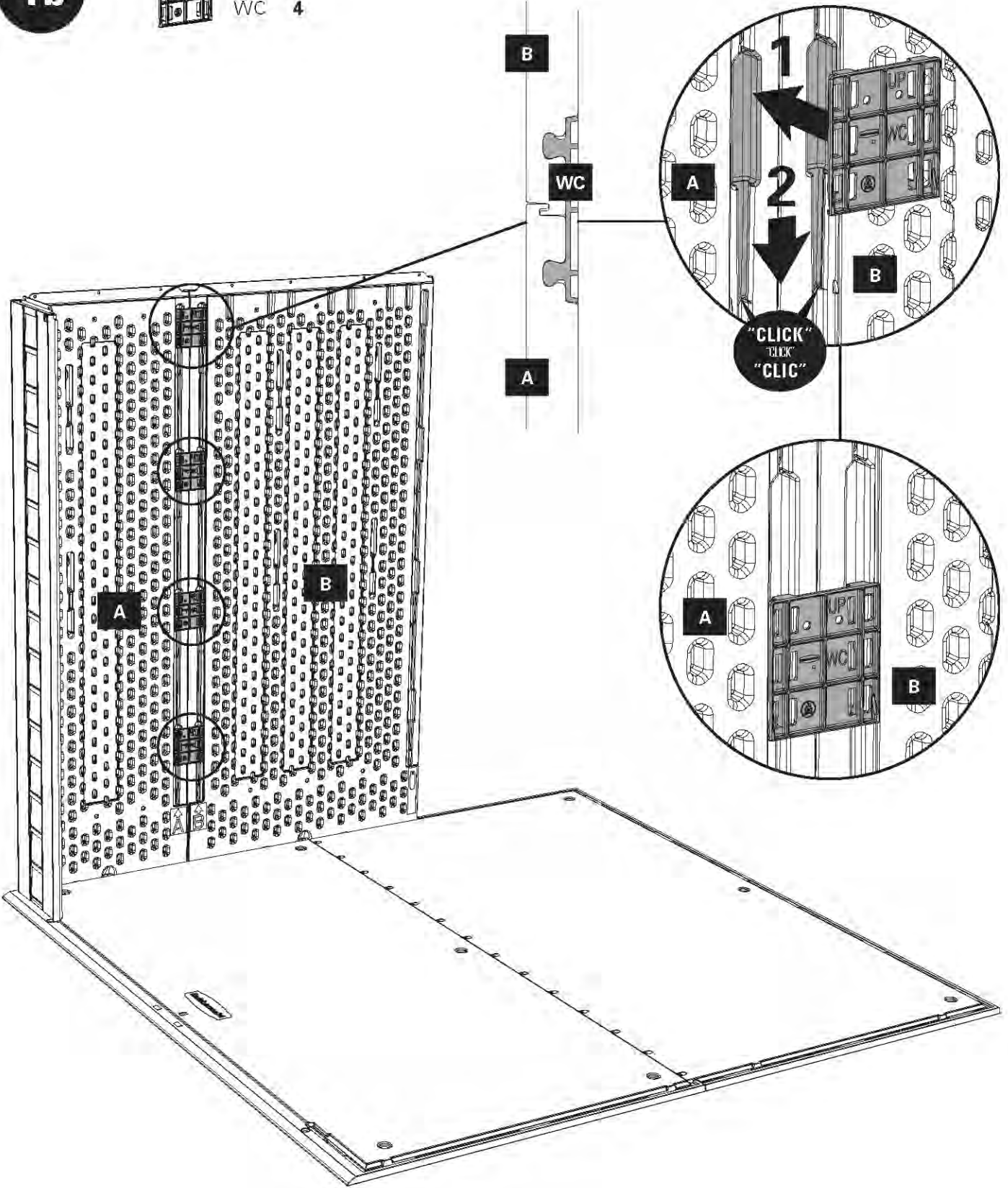

**5a**



C 1

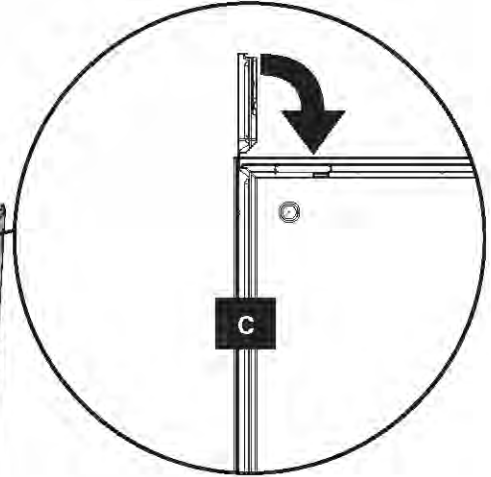

Top view  
Vista superior  
Vue d'en haut

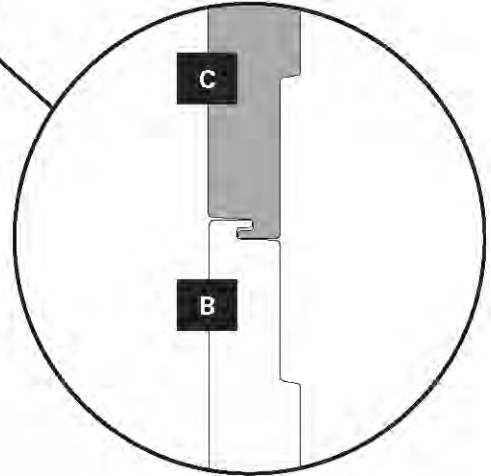

Overlap joint engagement  
Engranaje de junta superpuesta  
Emboîtement du joint à recouvrement

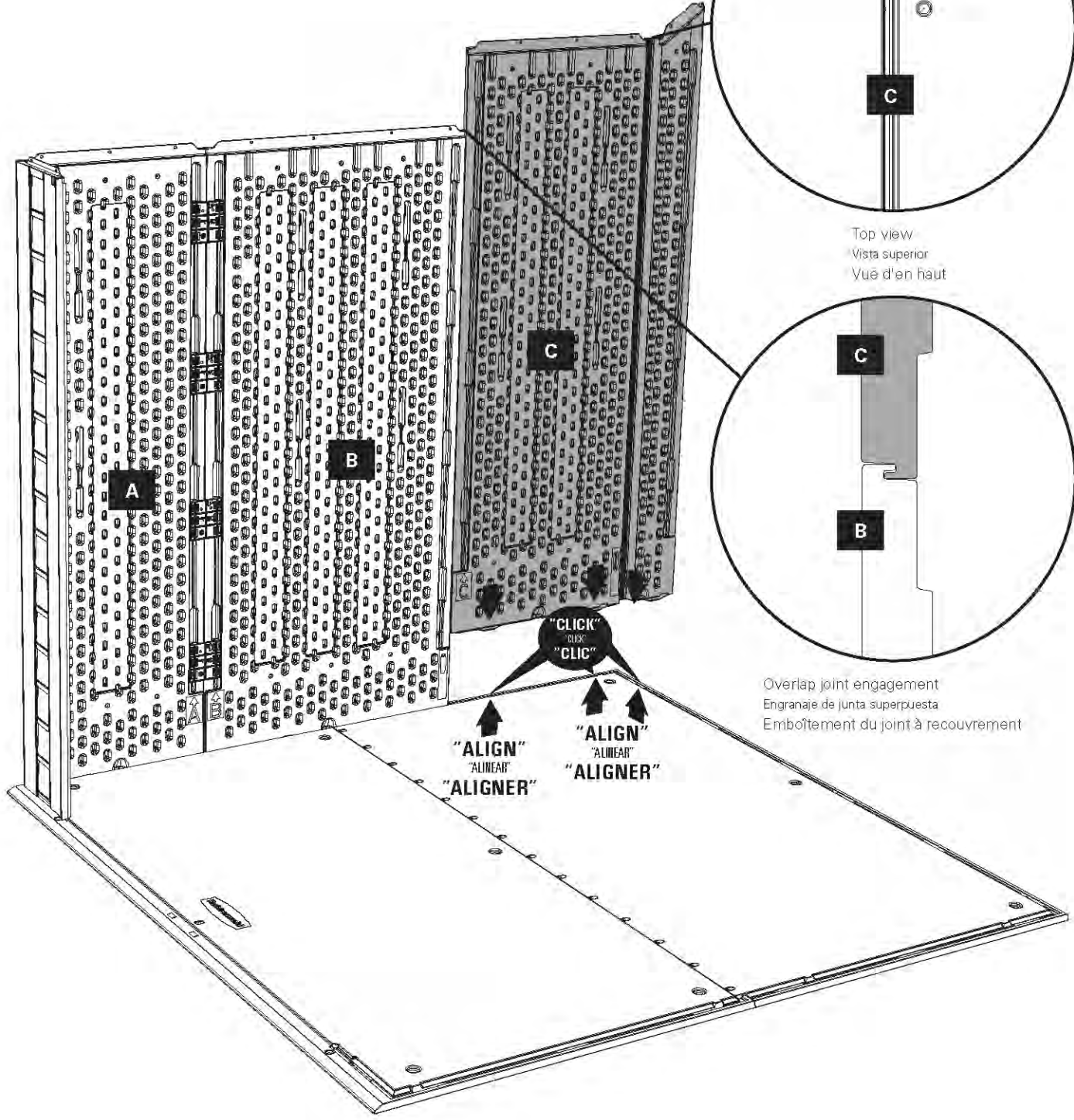

# 5b



WC 4

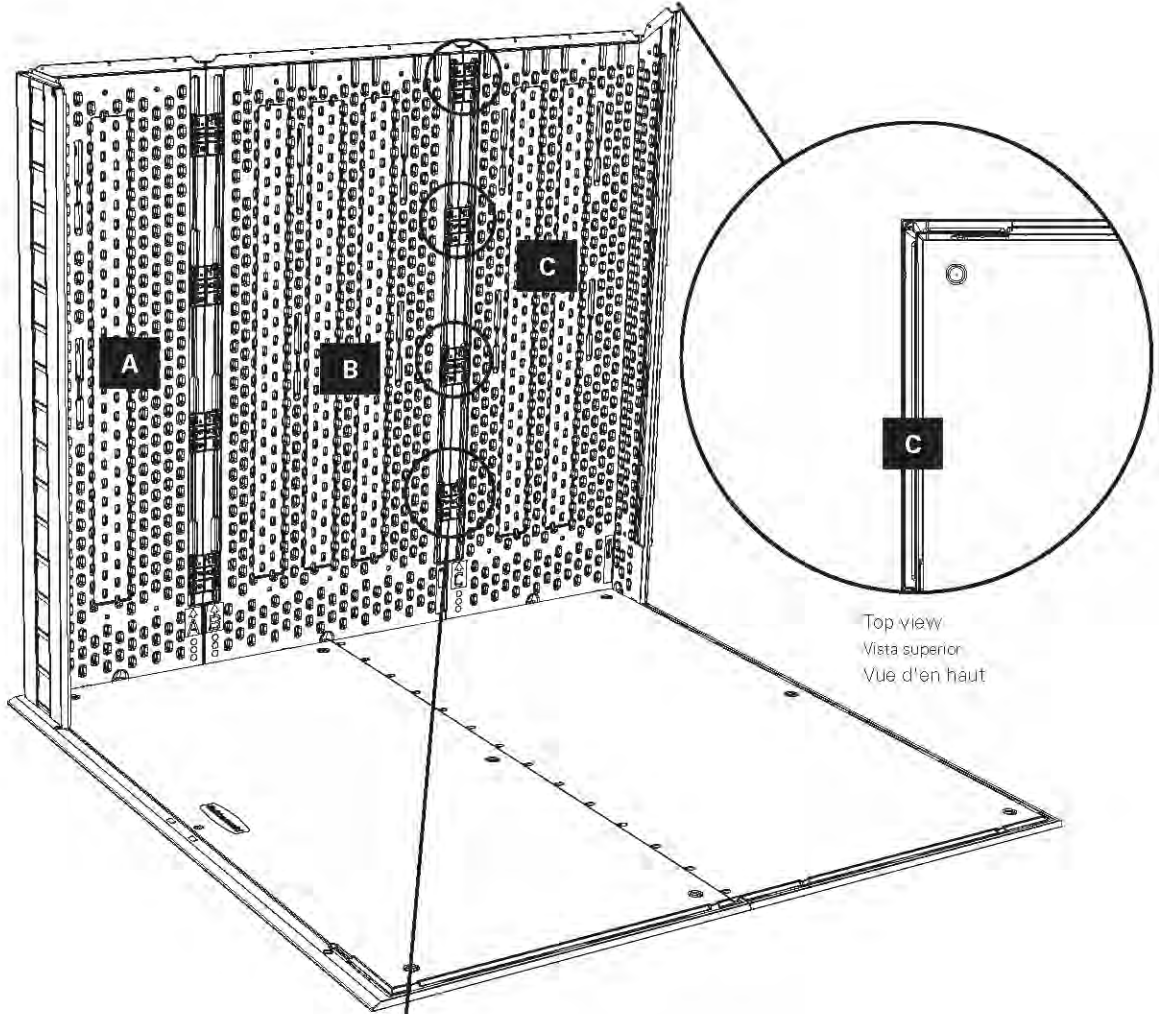

Top view  
Vista superior  
Vue d'en haut

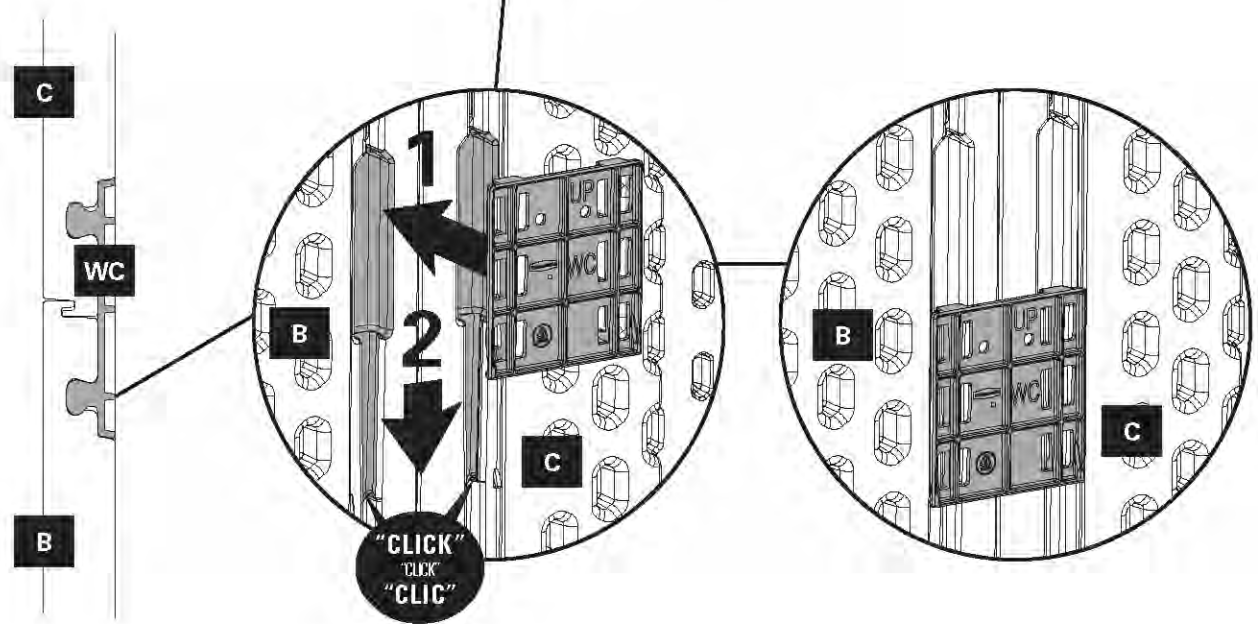

**6a**



D 1

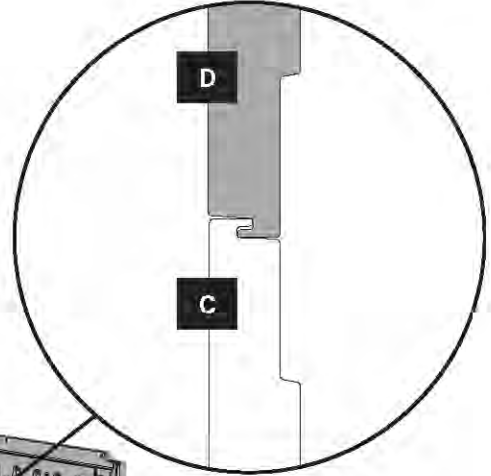

Overlap joint engagement  
Engranaje de junta superpuesta  
Emboîtement du joint à recouvrement

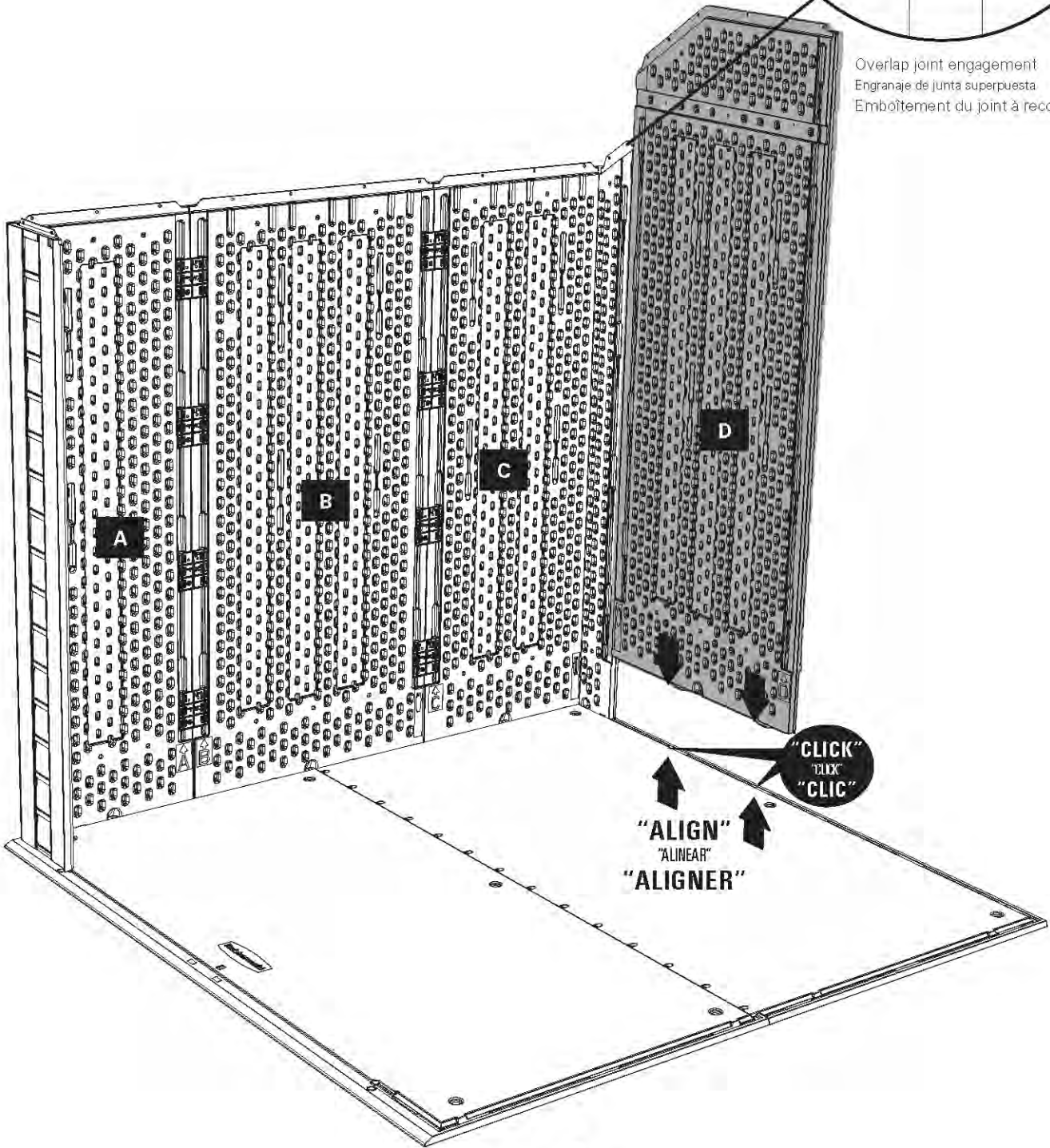



6b



WC 4

D installed into floor.

D instalada en el piso.

D installé dans le plancher.

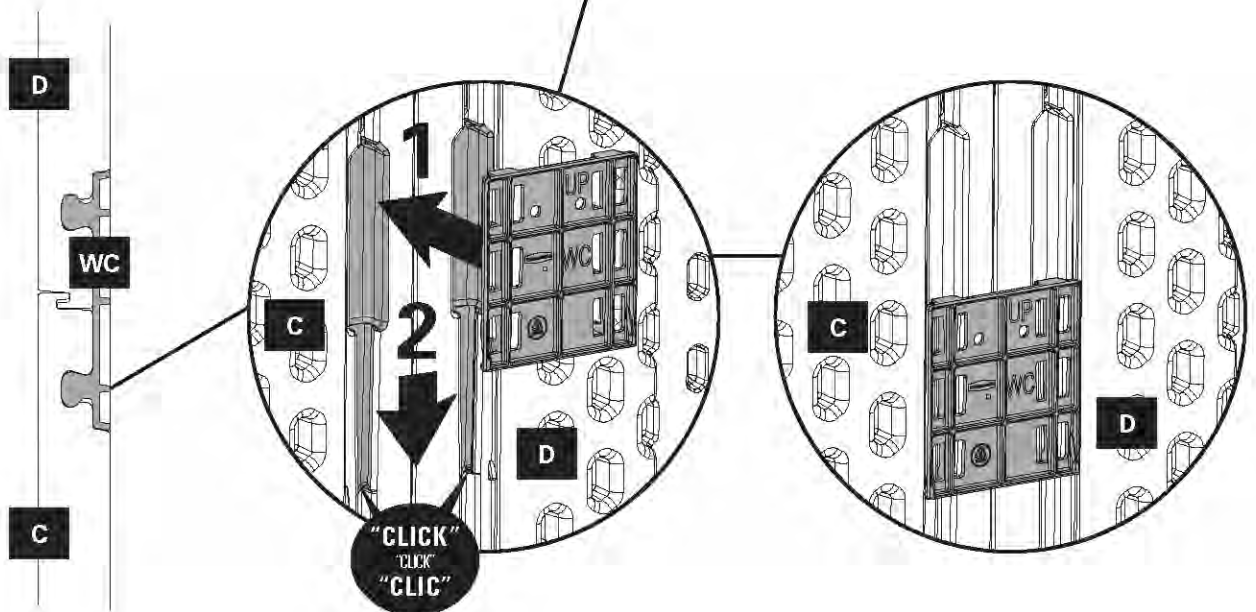
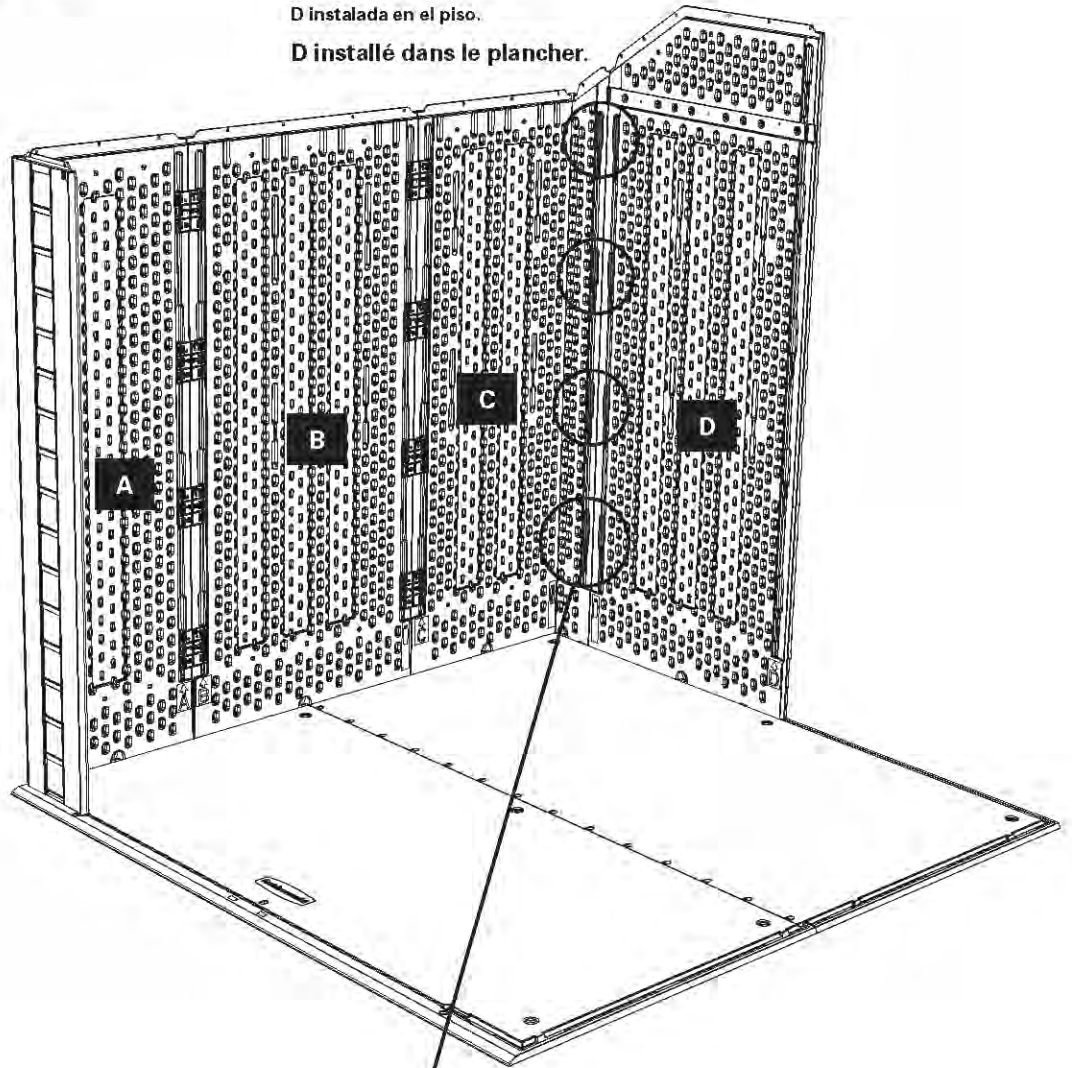

**7a**



G 1

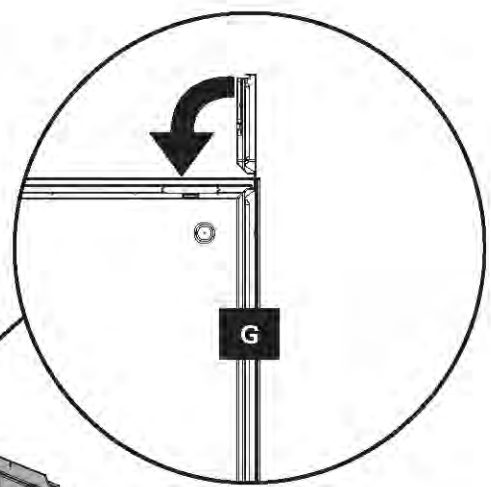

Top view  
Vista superior  
Vue d'en haut

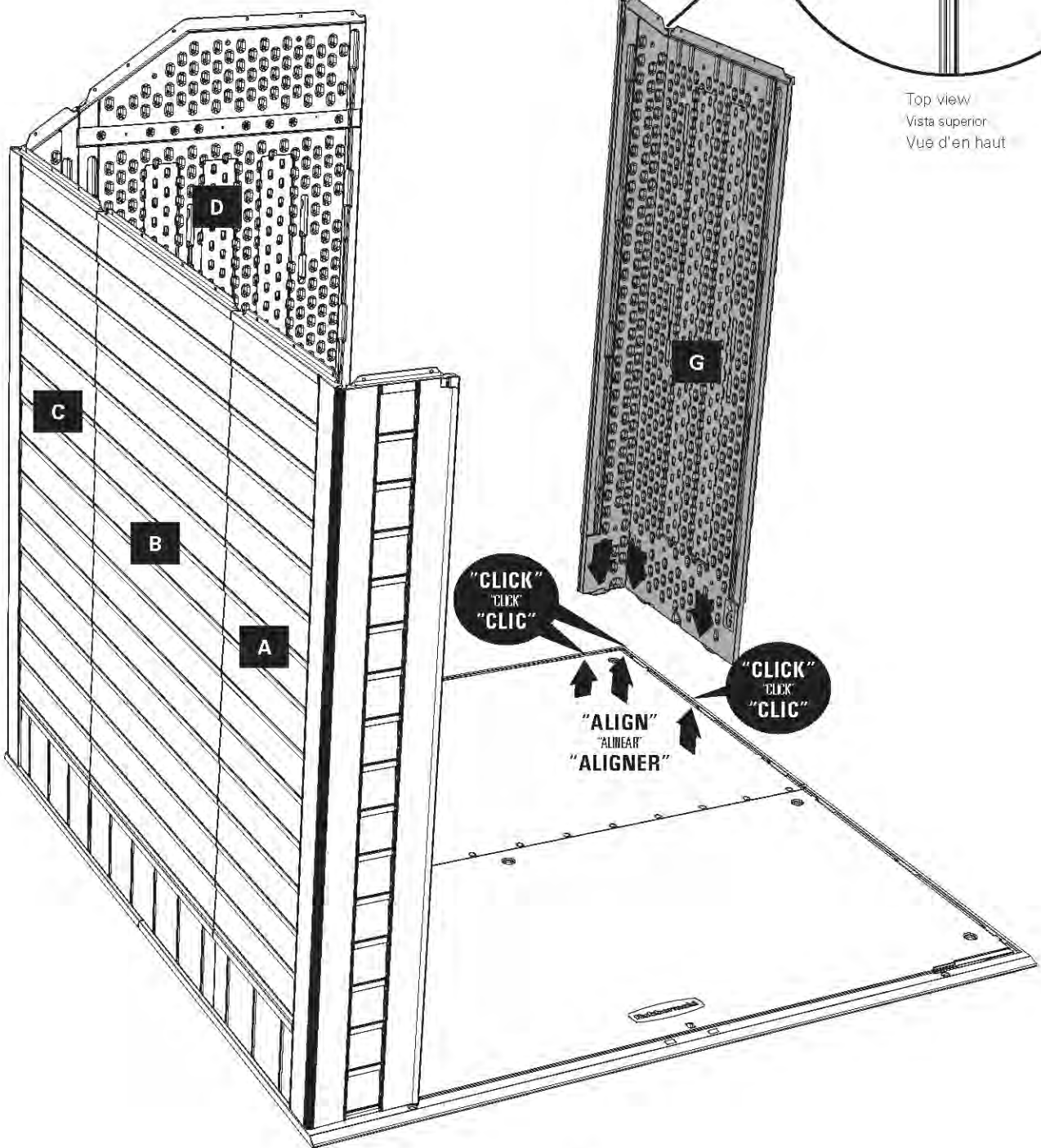

7b

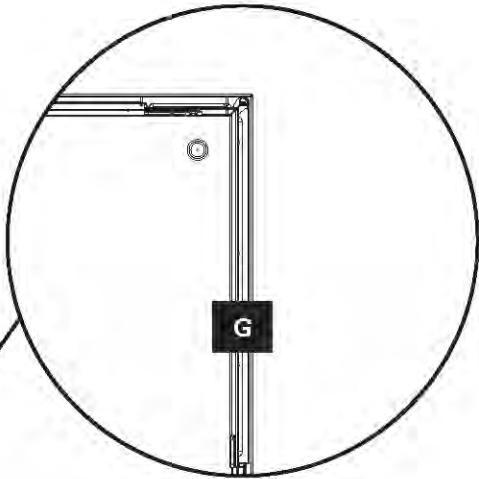
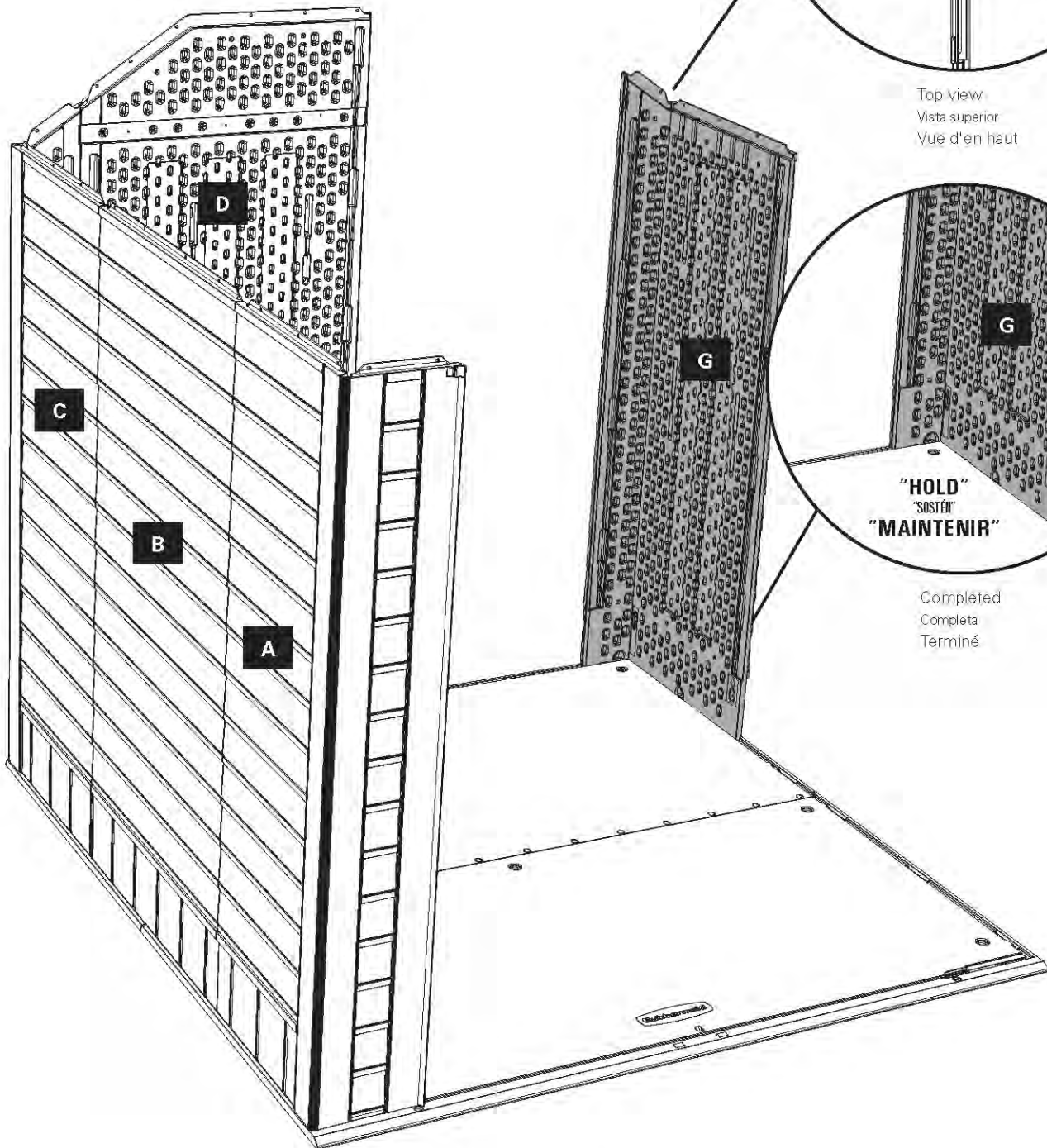

Top view  
Vista superior  
Vue d'en haut

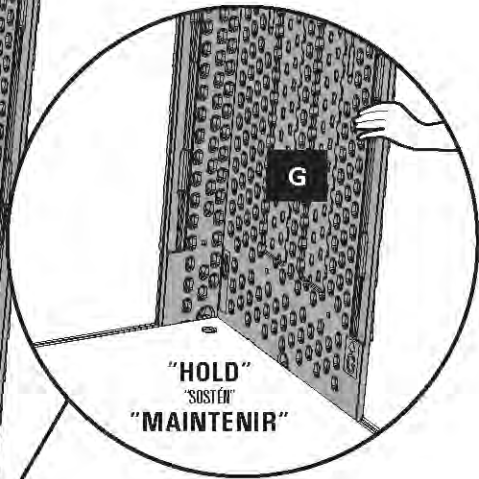

Completed  
Completa  
Terminé

**8a**

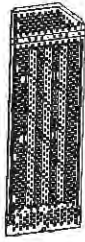

H 1

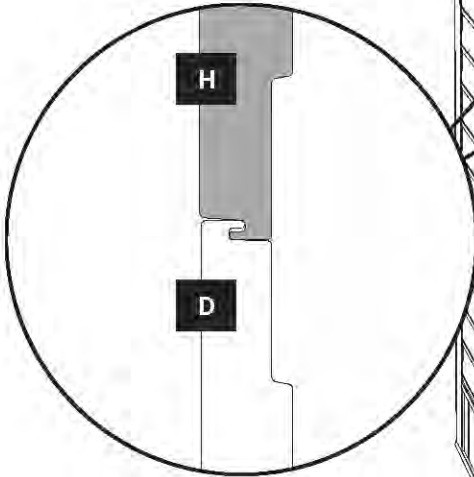

Overlap joint engagement  
 Engranaje de junta superpuesta  
 Emboîtement du joint à recouvrement

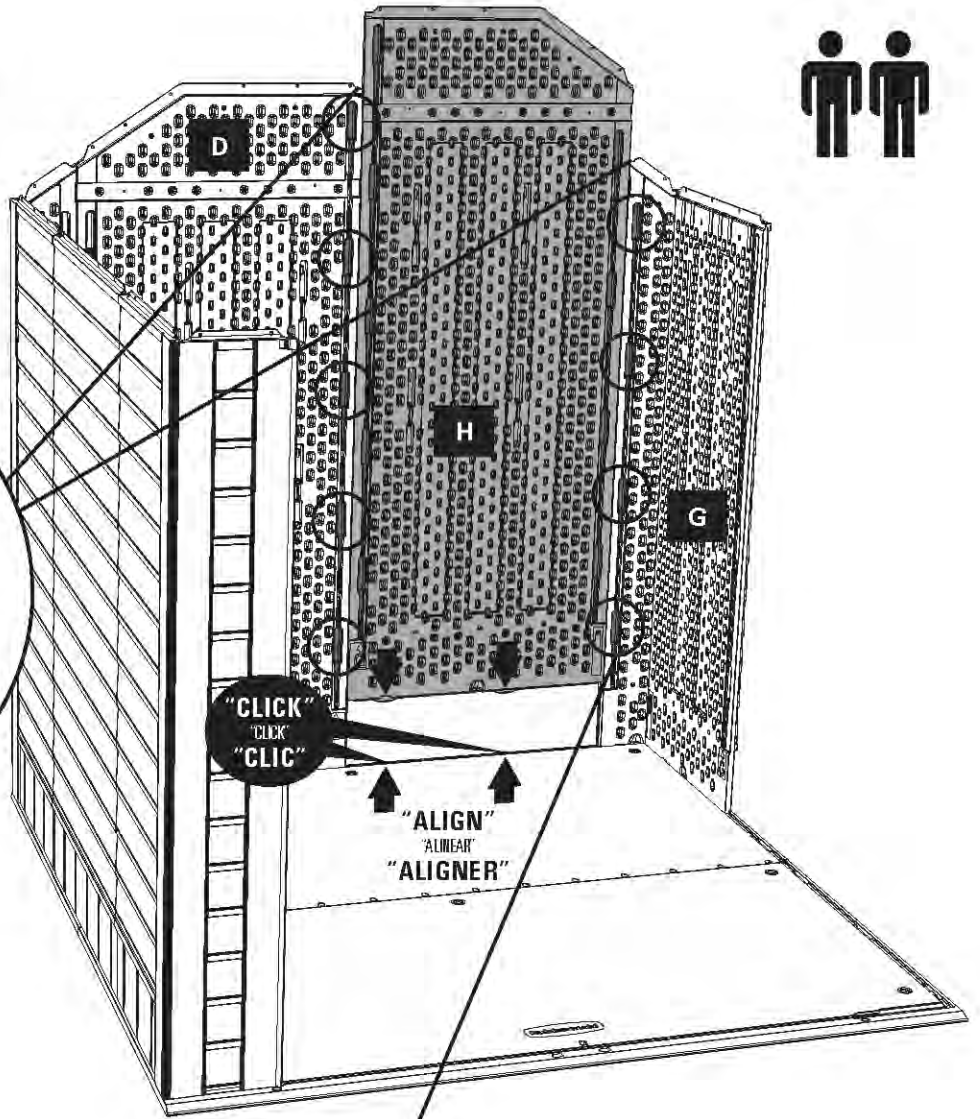

**"CLICK"**  
 "CLICK"  
 "CLIC"

**"ALIGN"**  
 "ALINEAR"  
 "ALIGNER"

**8b**



WC 9

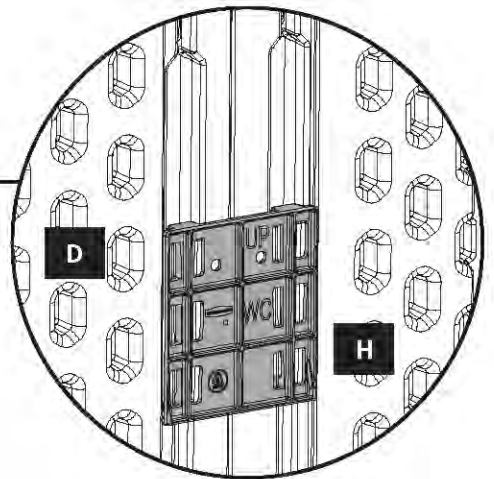
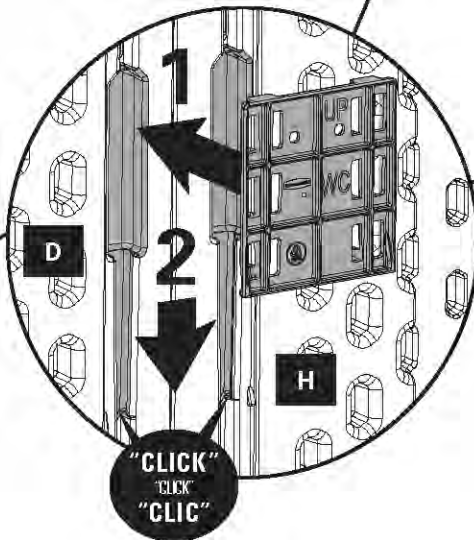
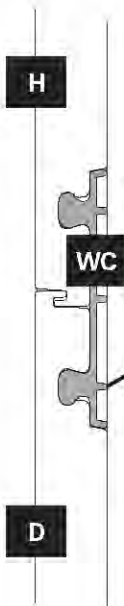

**9a**



F 1

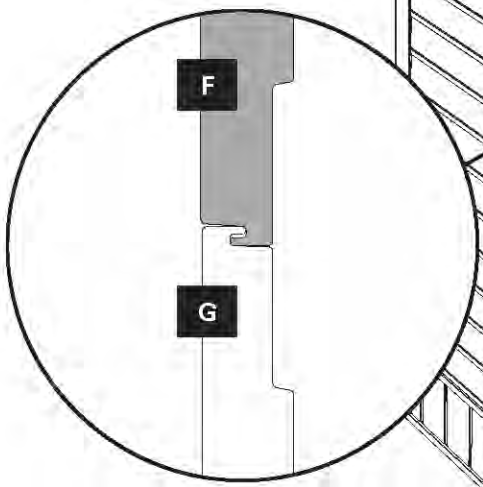

Overlap joint engagement  
 Engranaje de junta superpuesta  
 Emboîtement du joint à recouvrement

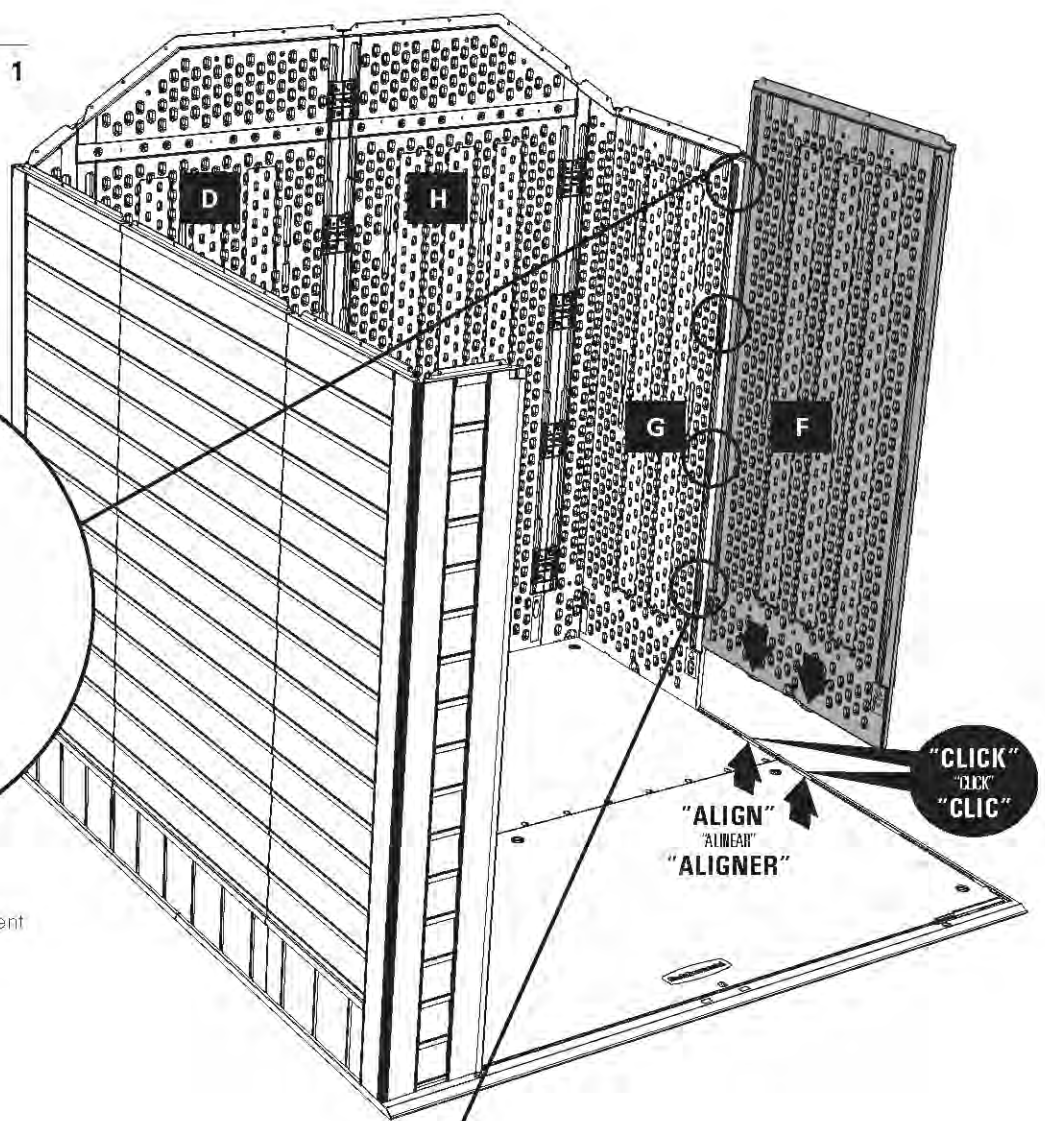

"CLICK"  
 "CLIK"  
 "CLIC"  
 "ALIGN"  
 "ALINEAR"  
 "ALIGNER"

**9b**



WC 4

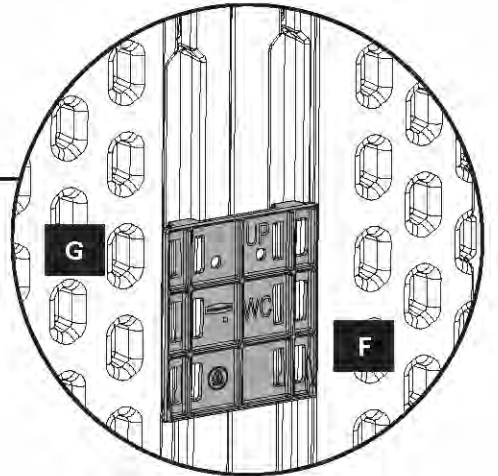
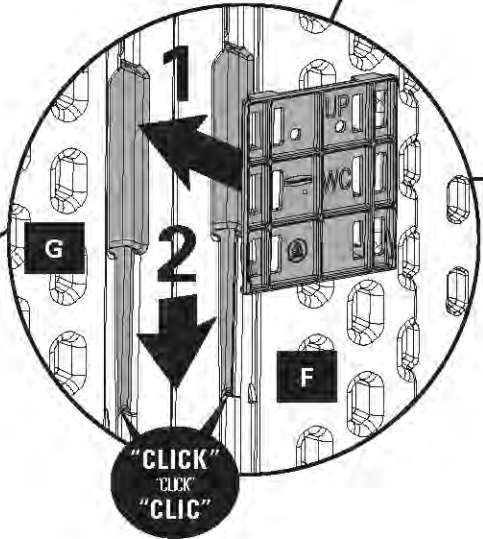
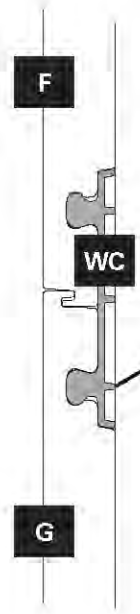

"CLICK"  
 "CLIK"  
 "CLIC"

10a



E 1

Overlap joint engagement  
Engranaje de junta superpuesta  
Emboîtement du joint à recouvrement

Top view  
Vista superior  
Vue d'en haut

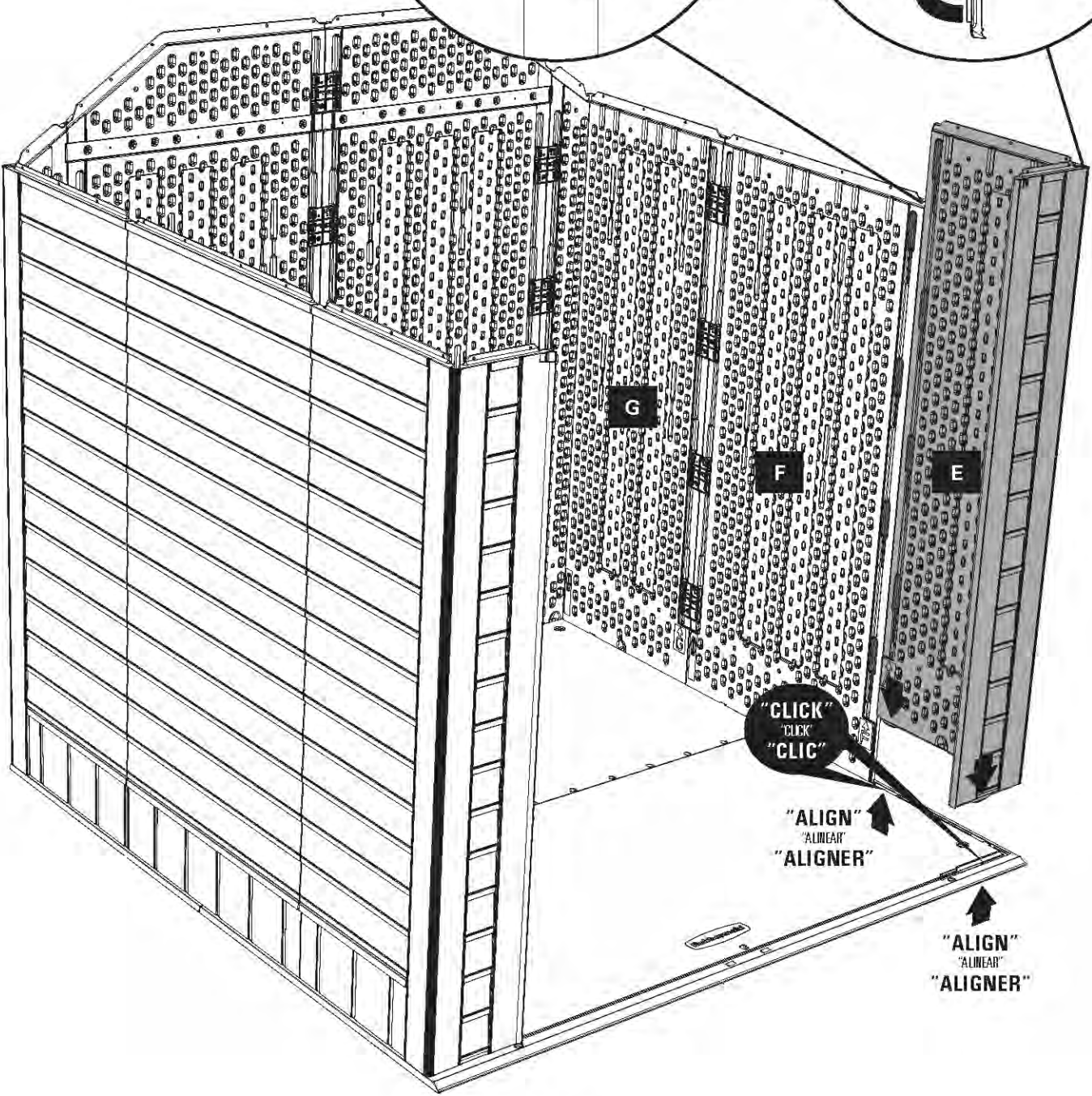
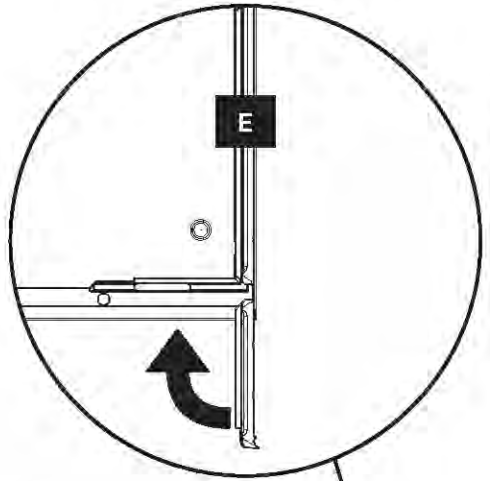
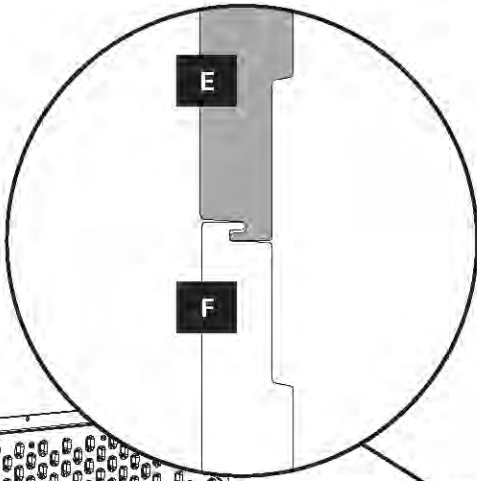

# 10b



WC 4

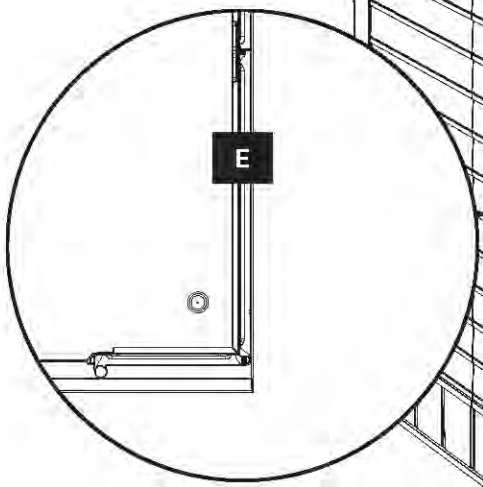

Top view  
Vista superior  
Vue d'en haut

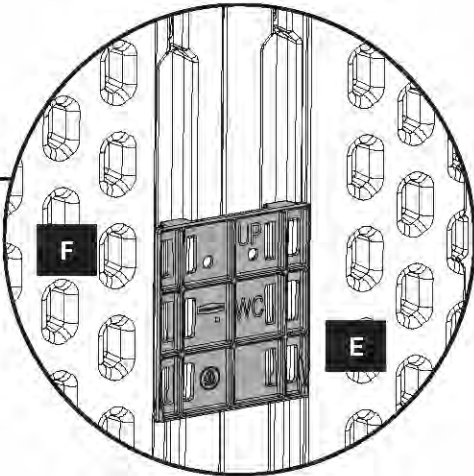
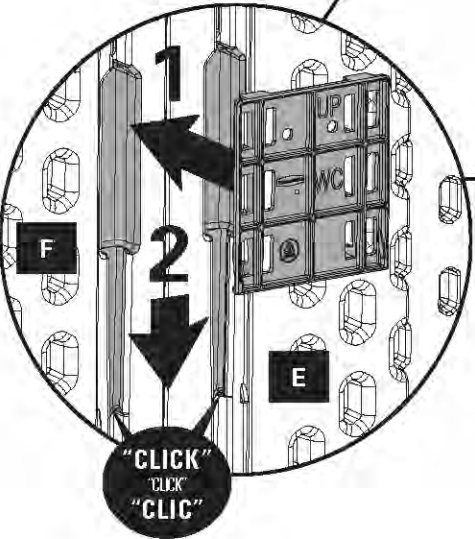
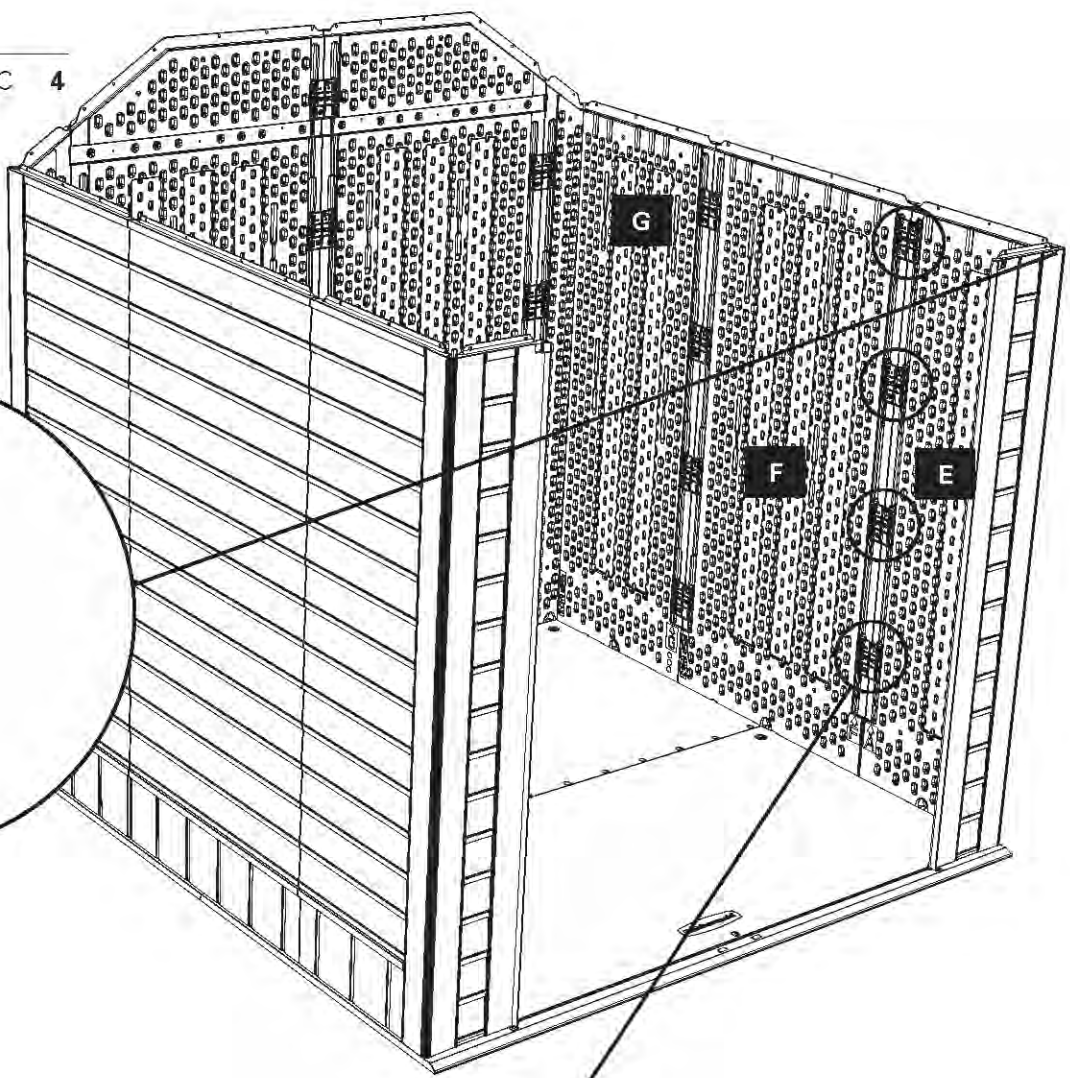

11



L 1

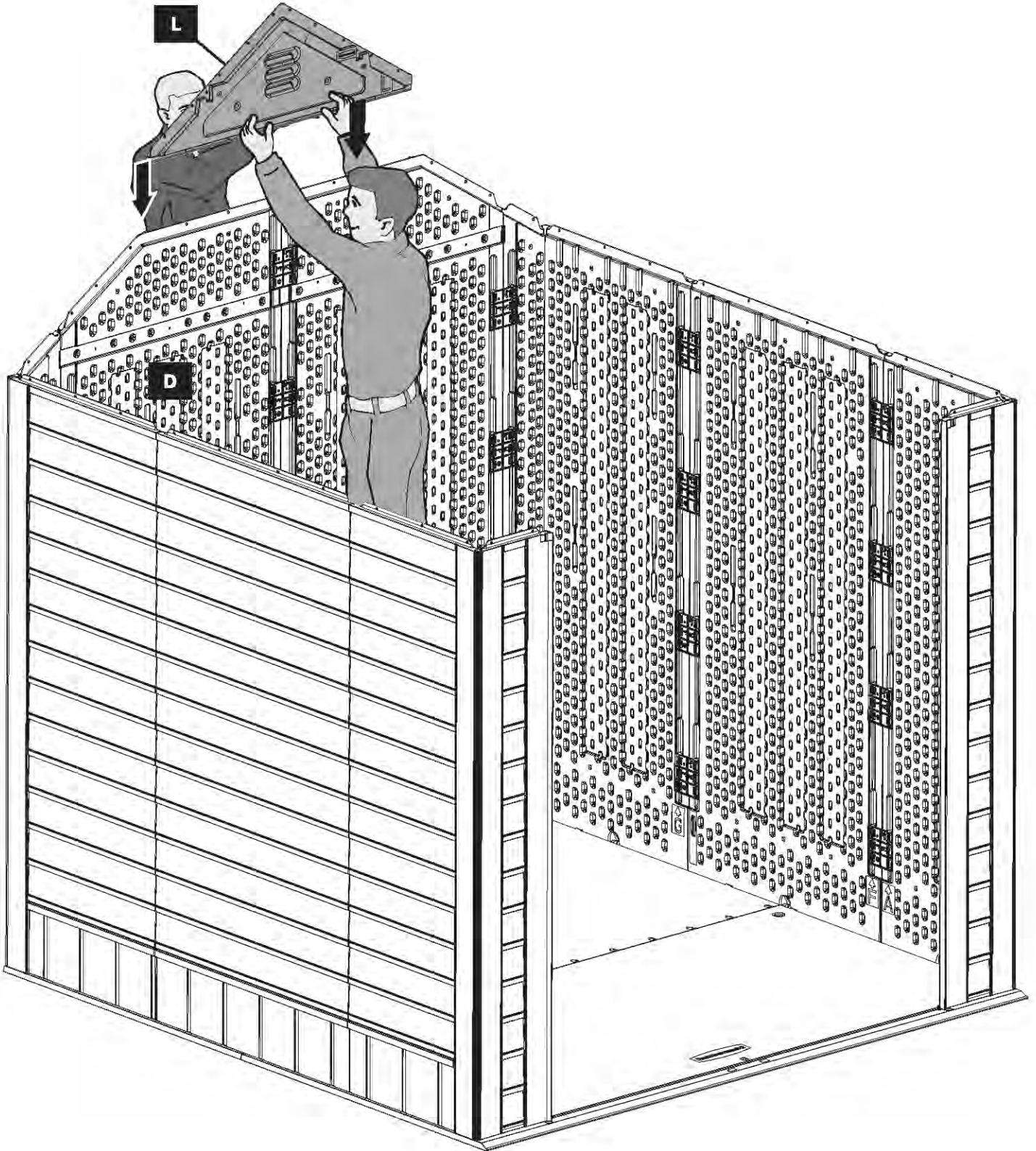
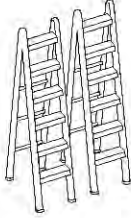



11

Continued.  
Continúa.  
Suite.



AA

6



**DO NOT**  
overtighten screws!  
¡NO ajuste los tornillos en exceso!

**ÉVITEZ**  
de trop serrer les boulons!

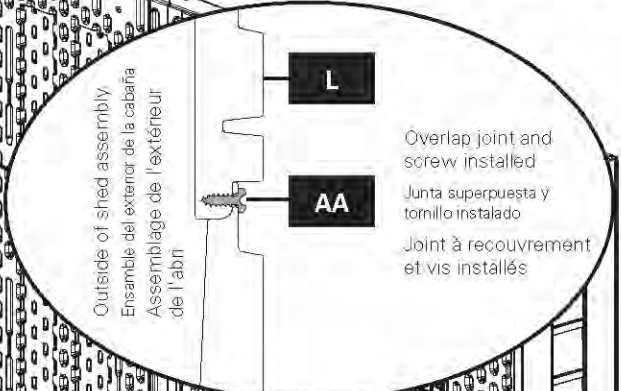
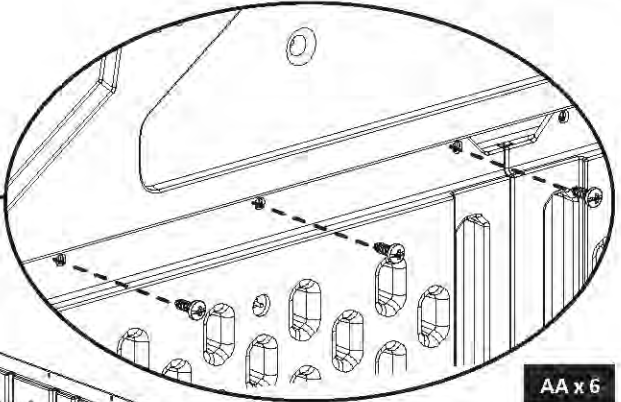
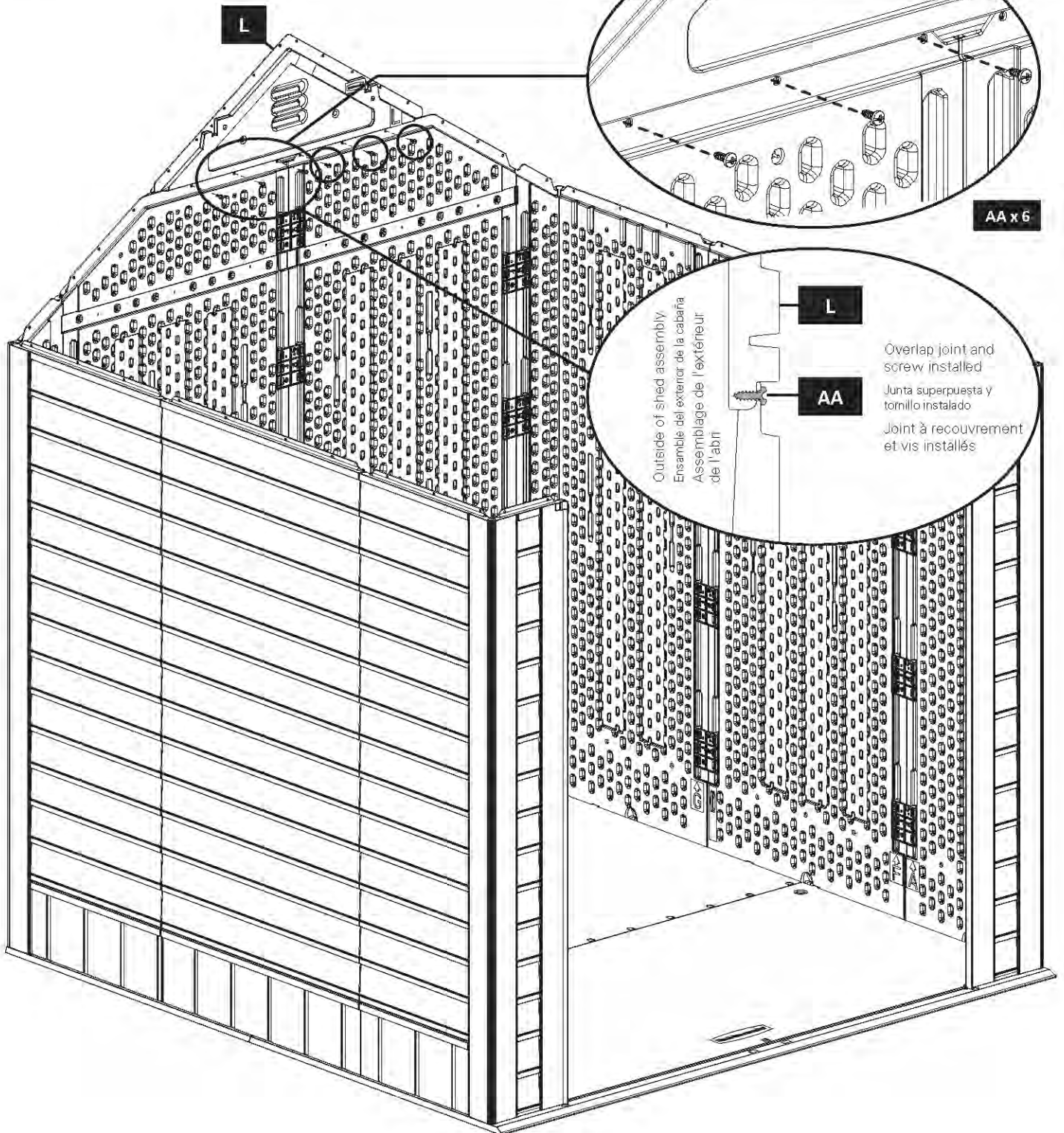
12a

DR 1



N 1

BB 10



**DO NOT**  
overtighten screws!  
(N) ajuste los tornillos en exceso!

**ÉVITEZ**  
de trop serrer les boulons!

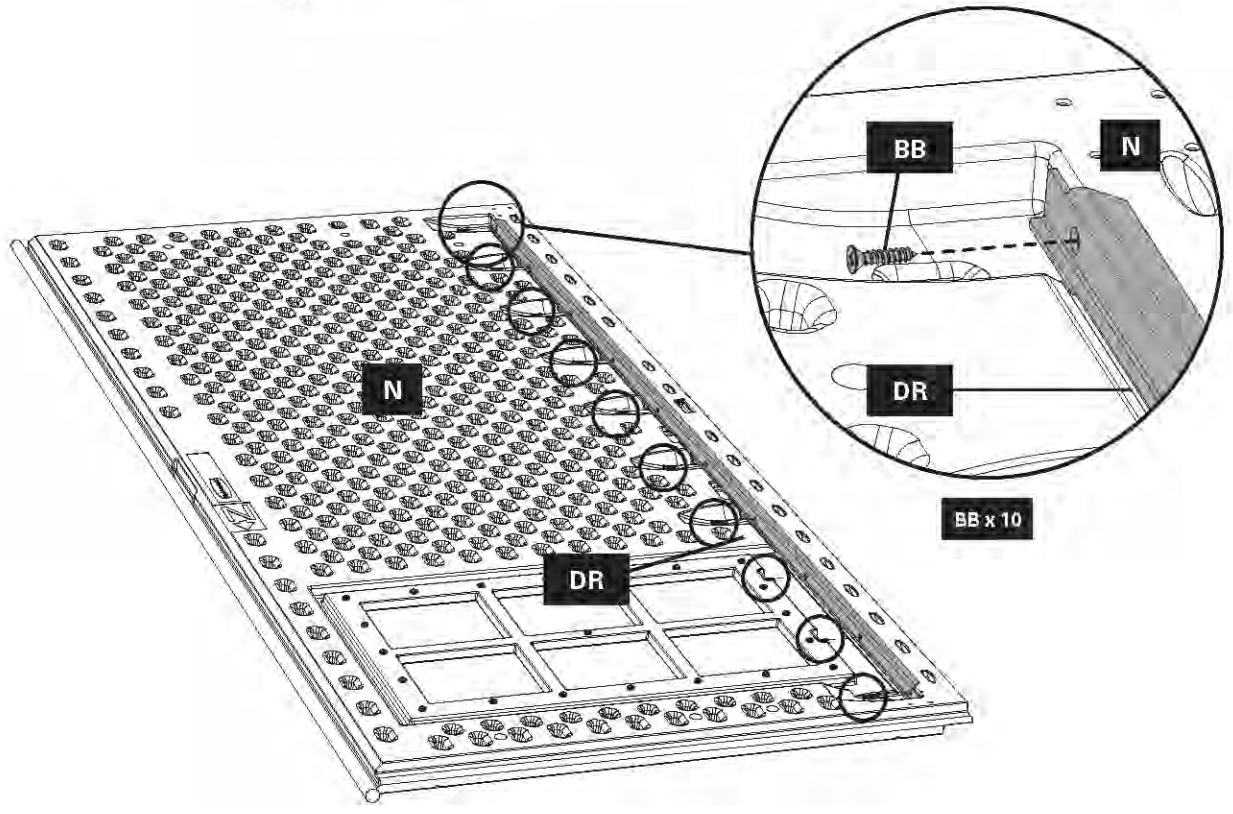
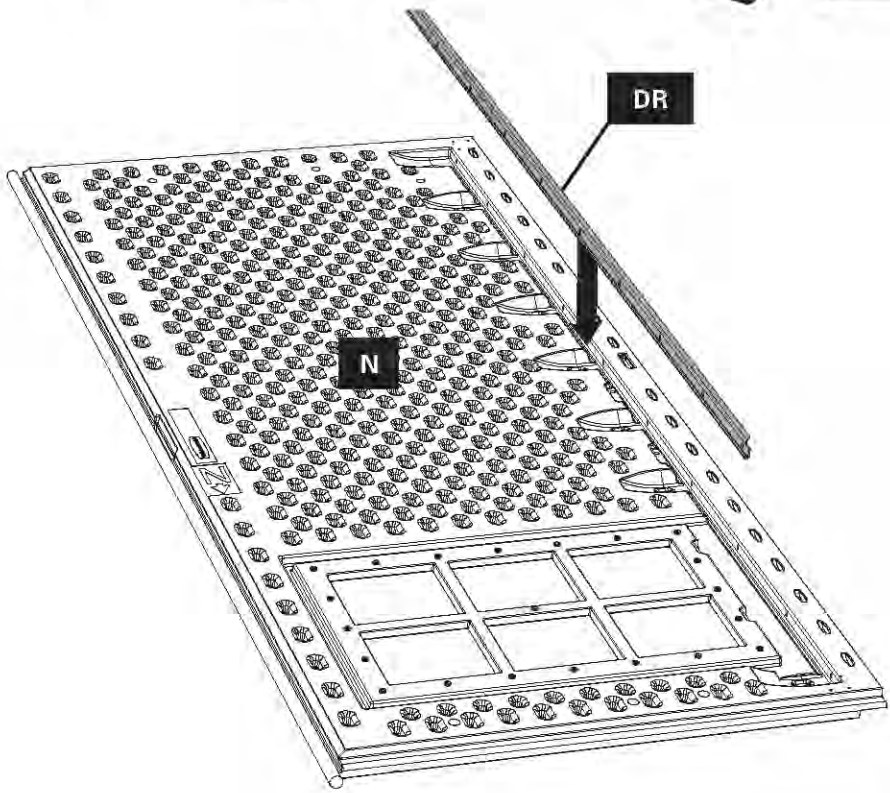

12b

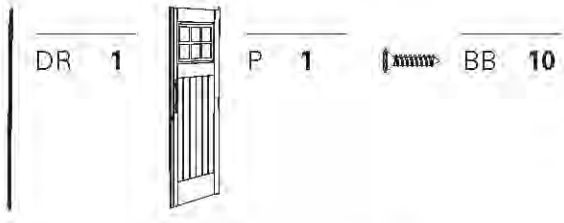

**DO NOT**  
overtighten screws!  
(NO ajuste los tornillos en exceso)

**ÉVITEZ**  
de trop serrer les boulons!

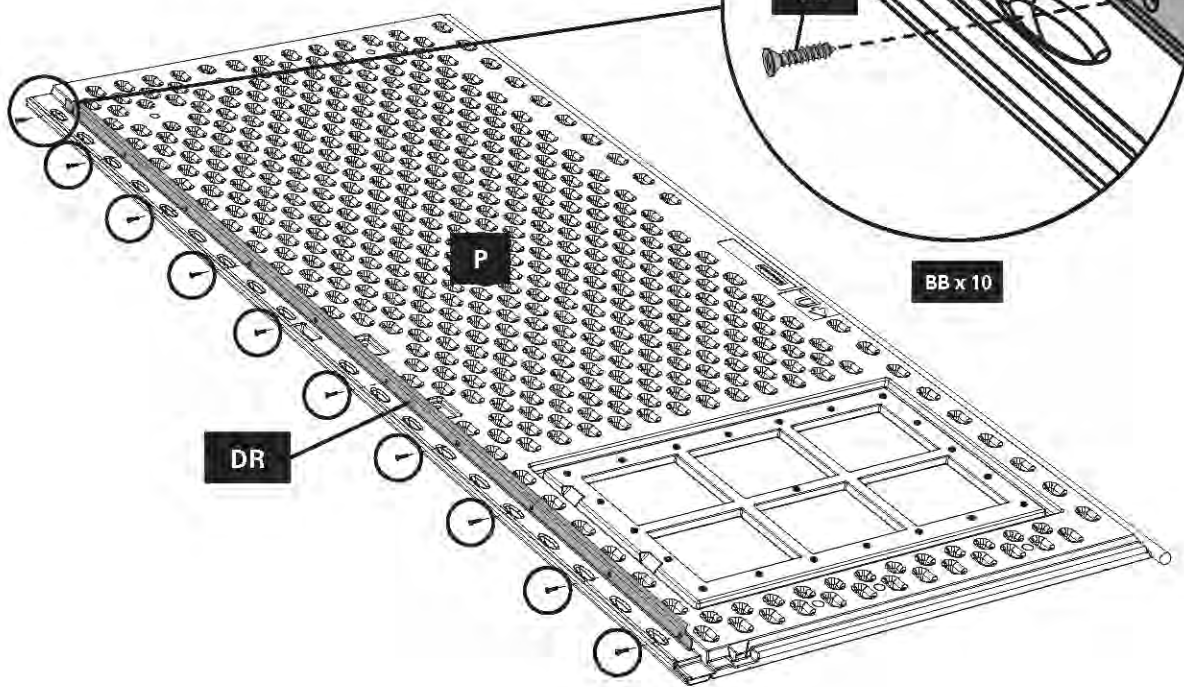
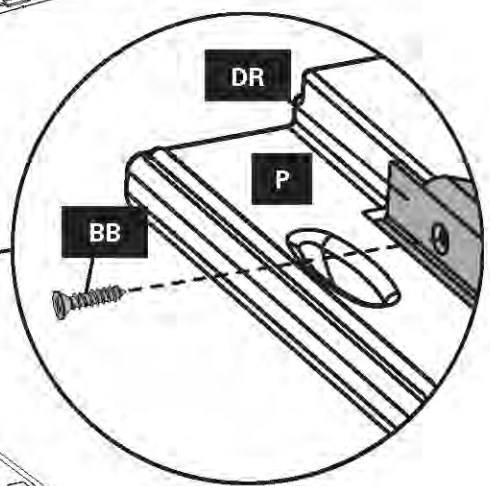
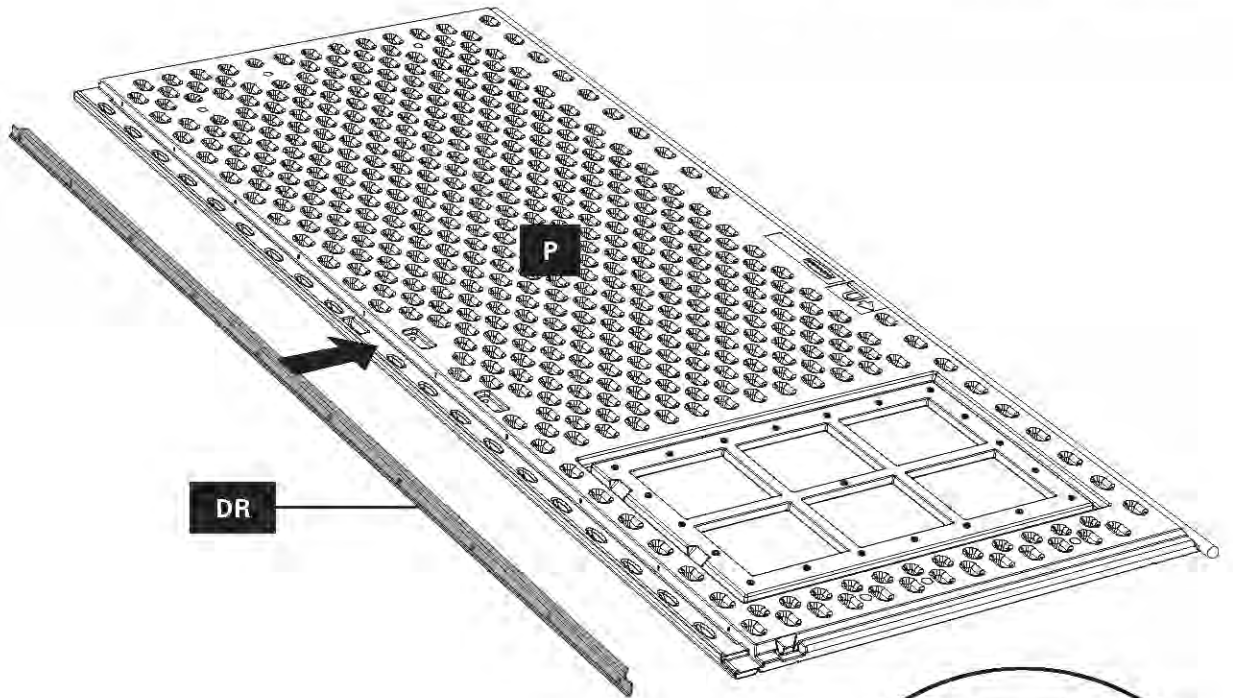

BB x 10

# 13a



DWF 2



DWG 2

Repeat steps 13a-13b for other DWF.

Repita los paso 13a a 13b para otro DWF.

Répéter les étapes 13a-13b pour d'autres DWF.

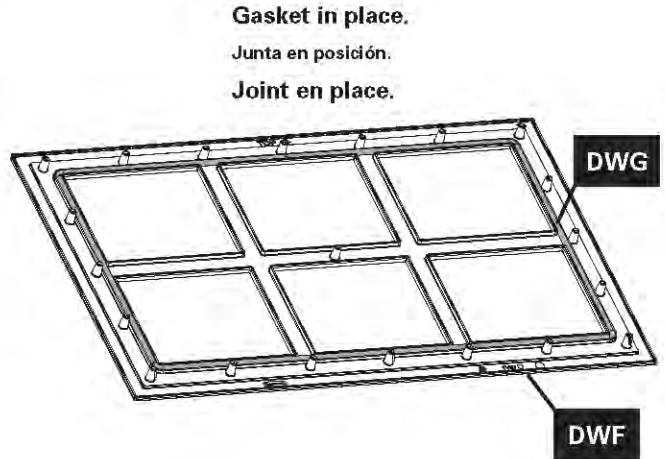
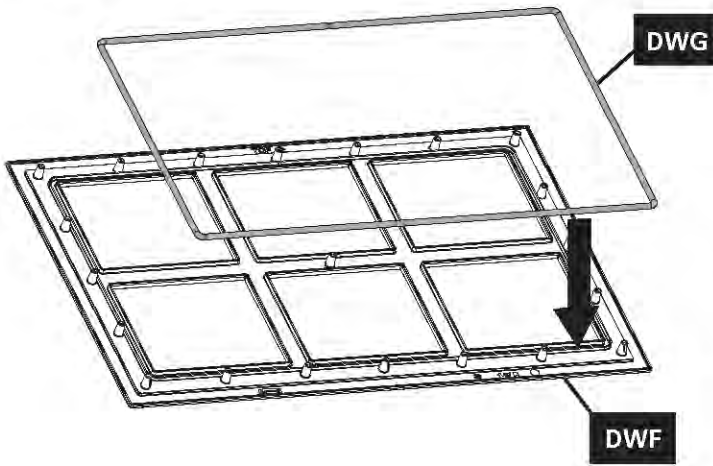

Gasket in place.

Junta en posición.

Joint en place.

# 13b



DW 2

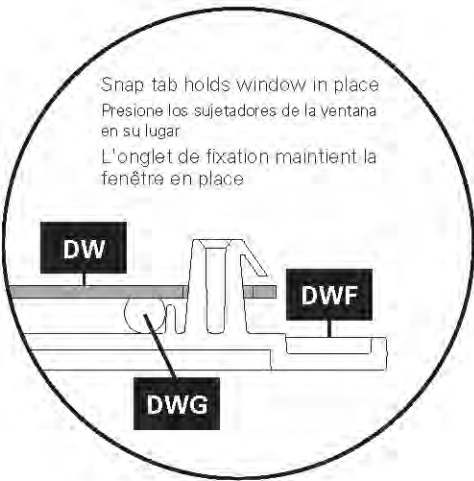
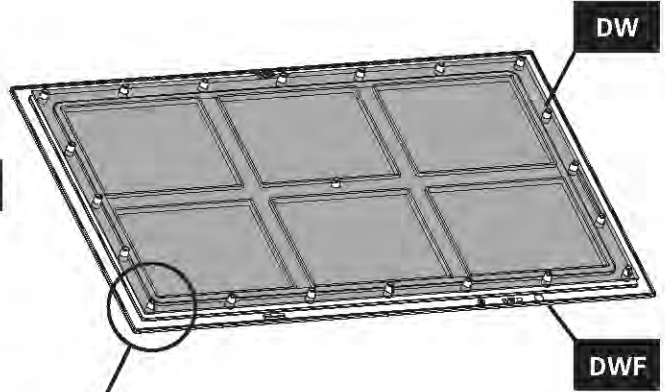
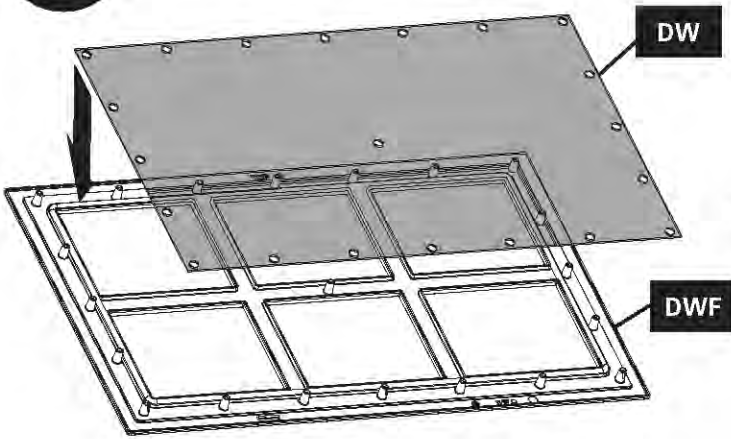

Snap tab holds window in place  
 Presione los sujetadores de la ventana  
 en su lugar  
 L'onglet de fixation maintient la  
 fenêtre en place

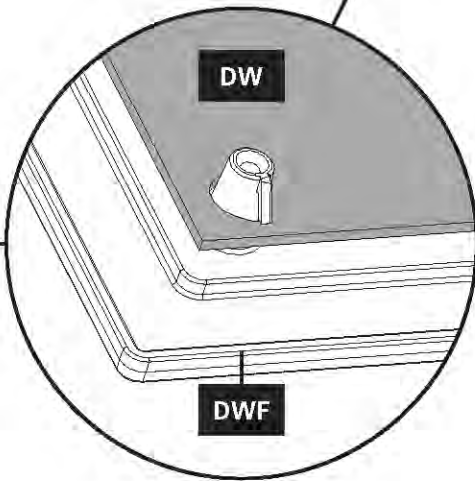

13c

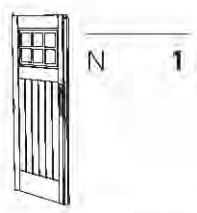

⊕ CC 38

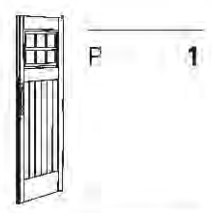

⊙ JJ 38

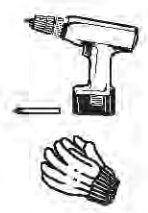

**DO NOT**  
overtighten screws!  
(NO ajuste los tornillos en exceso!)

**ÉVITEZ**  
de trop serrer les boulons!



Repeat for right door P.  
Repita para puerta derecha P.  
Répéter l'opération pour  
la porte de droite P.

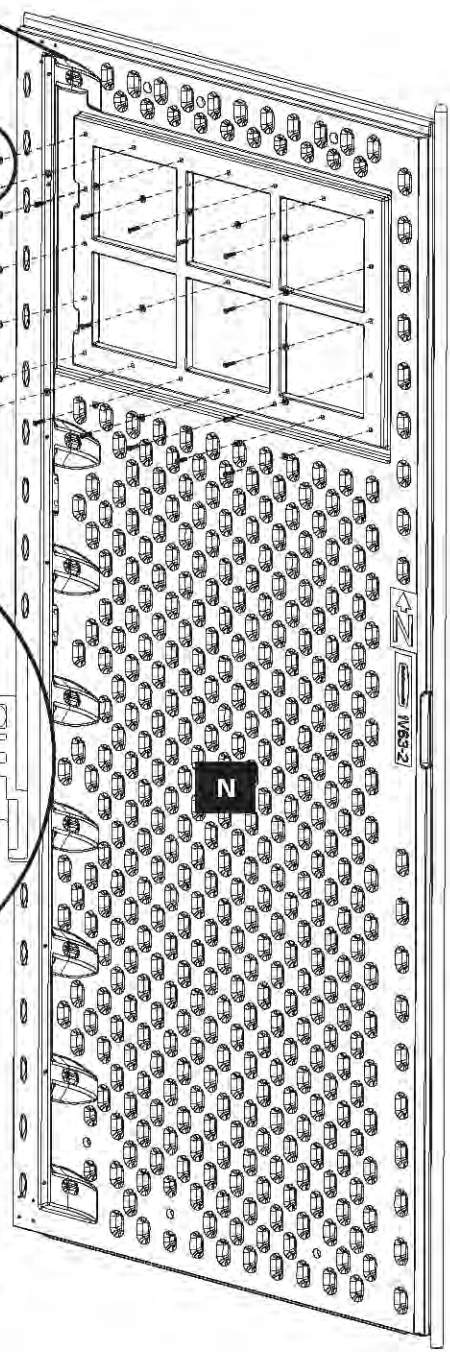
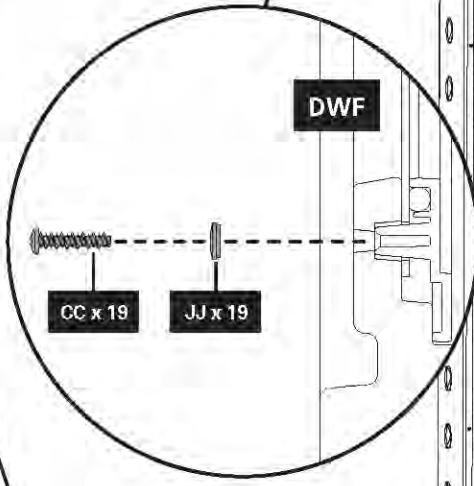

DW/DWG/DWF assembly.  
Ensemble de DW/DWG/DWF.  
Assemblage DW / DWG / DWF.

14

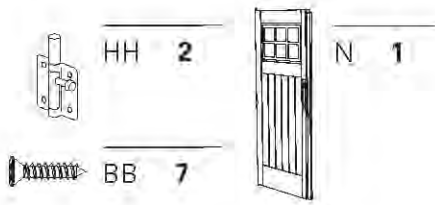

**DO NOT**  
overtighten screws!  
*(NI ajuste los tornillos en exceso)*

**ÉVITEZ**  
de trop serrer les boulons!

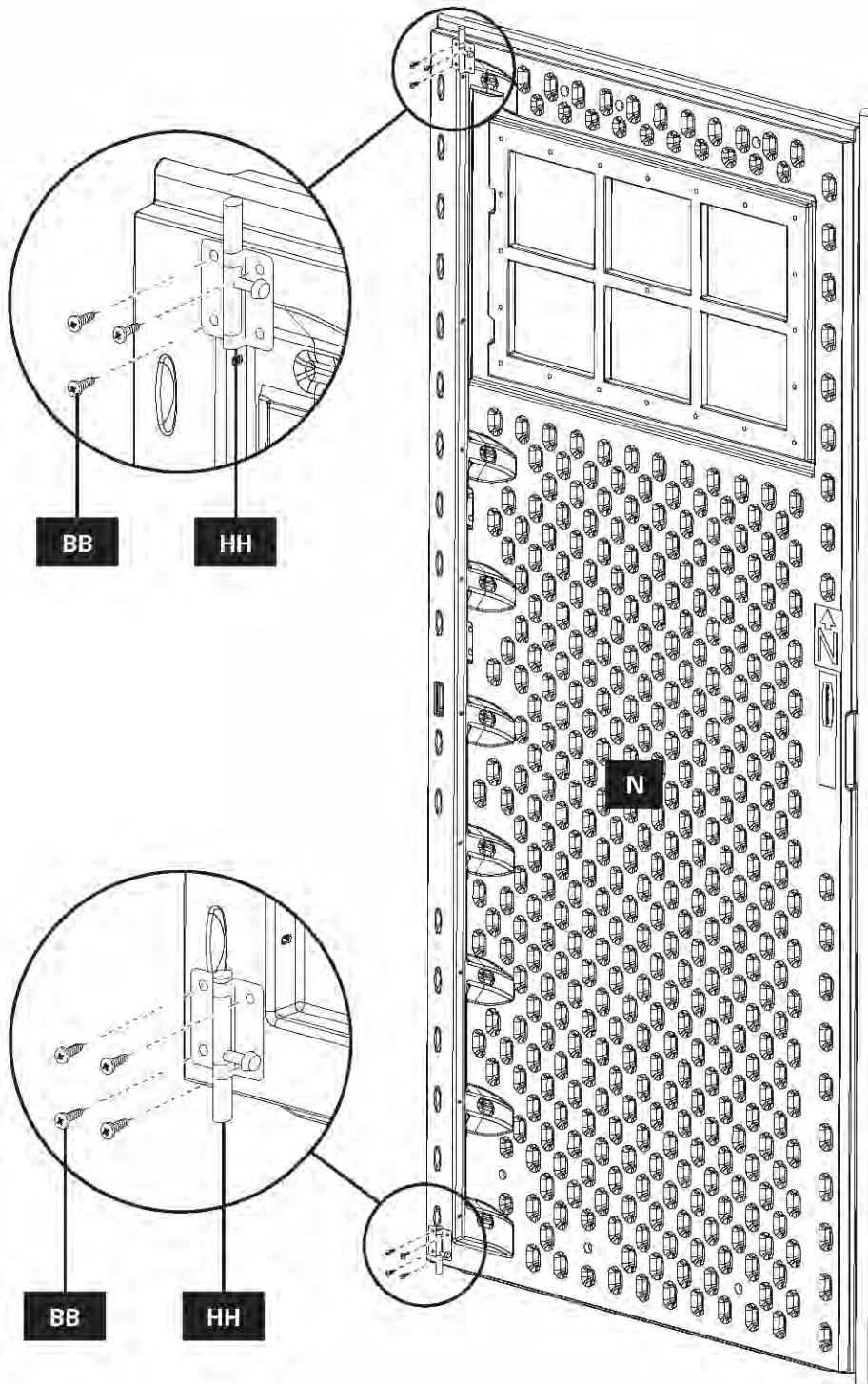

# 14a

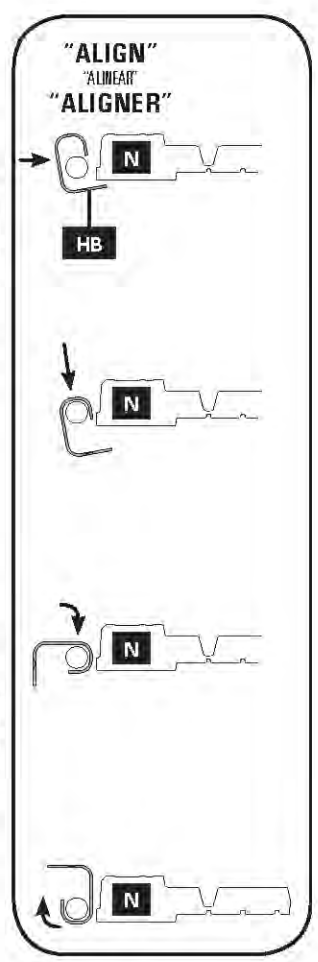
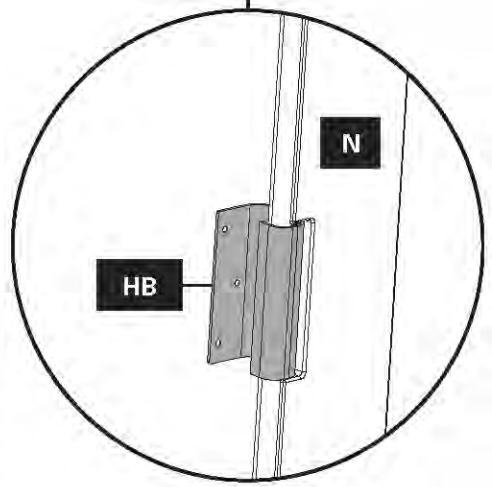
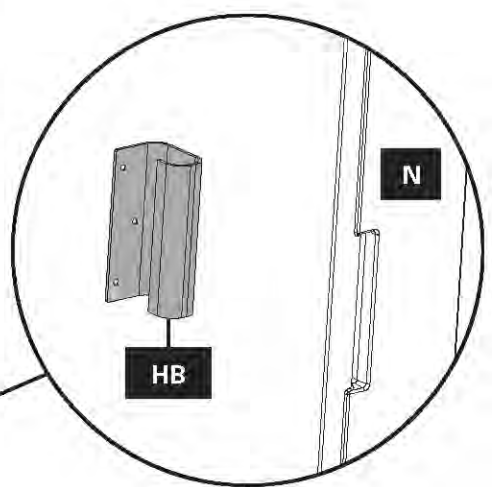
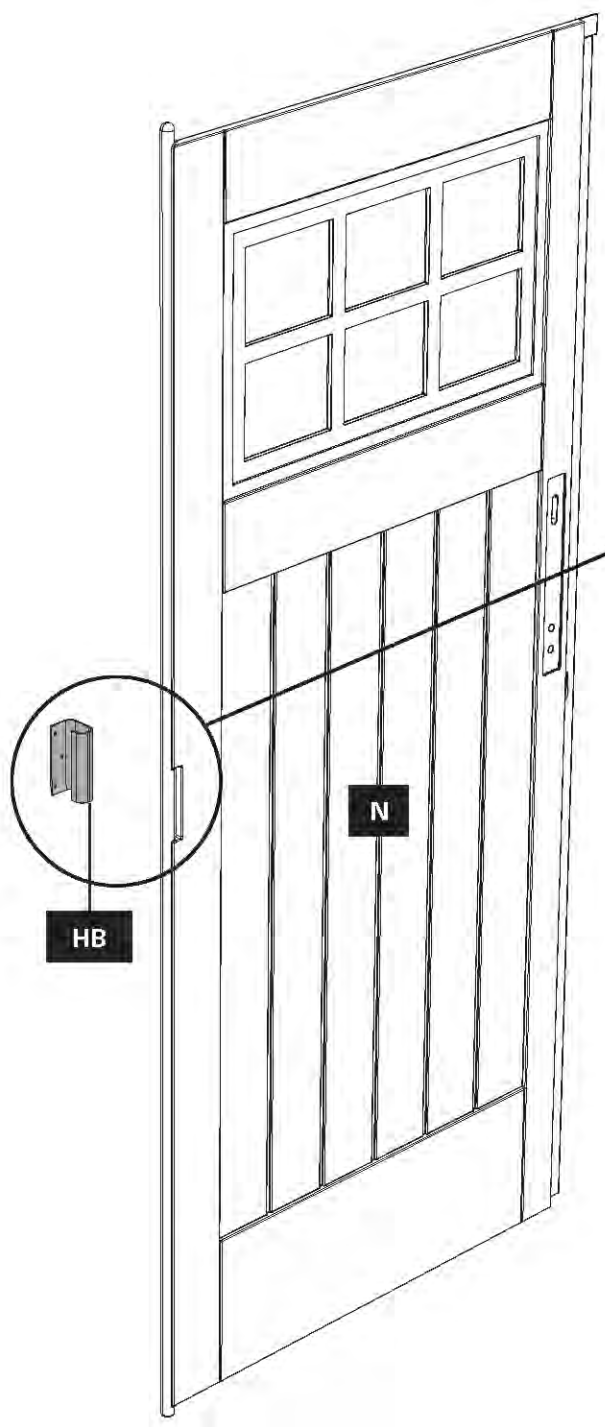
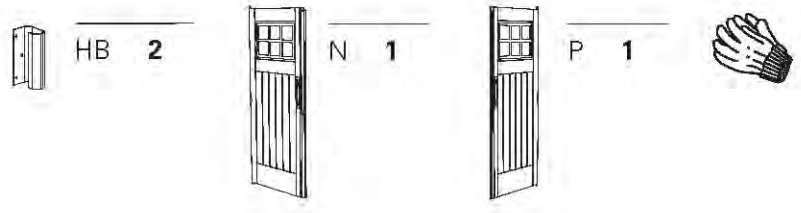

Repeat for right door P.  
Repita para puerta derecha P.  
Répéter l'opération pour la porte de droite P.

14b

BB 6



**DO NOT**  
overtighten screws!

¡NO apriete los tornillos en exceso!

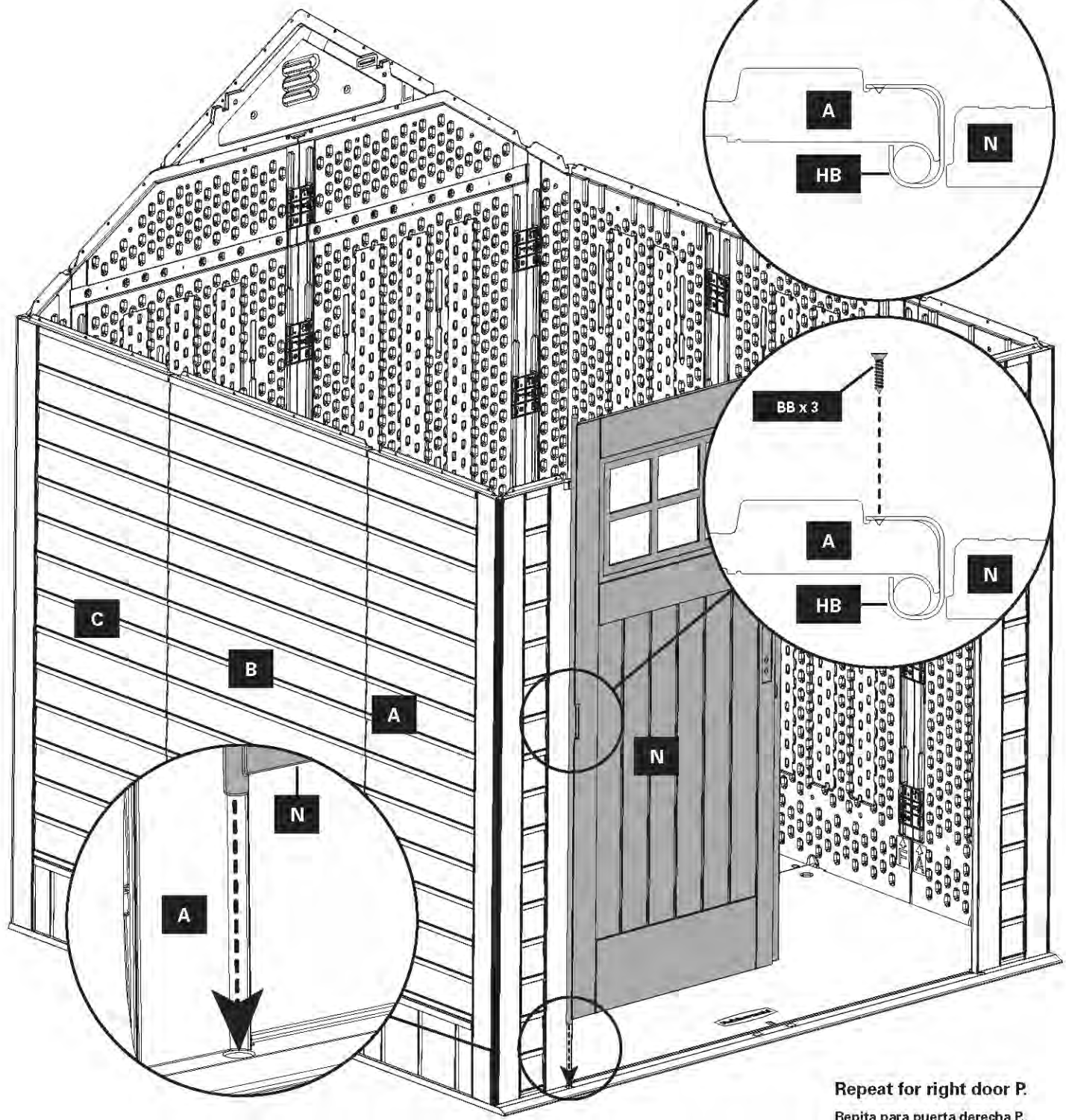

**ÉVITEZ**  
de trop serrer les boulons!



Repeat for right door P.  
 Repita para puerta derecha P.  
 Répéter l'opération pour  
 la porte de droite P.



# 15a

- |   |    |   |
|---|----|---|
|  | AA | 6 |
|  | HD | 1 |
|  | M  | 1 |



**DO NOT**  
overtighten screws!

(NO ajuste los tornillos en exceso)

**ÉVITEZ**  
de trop serrer les boulons!

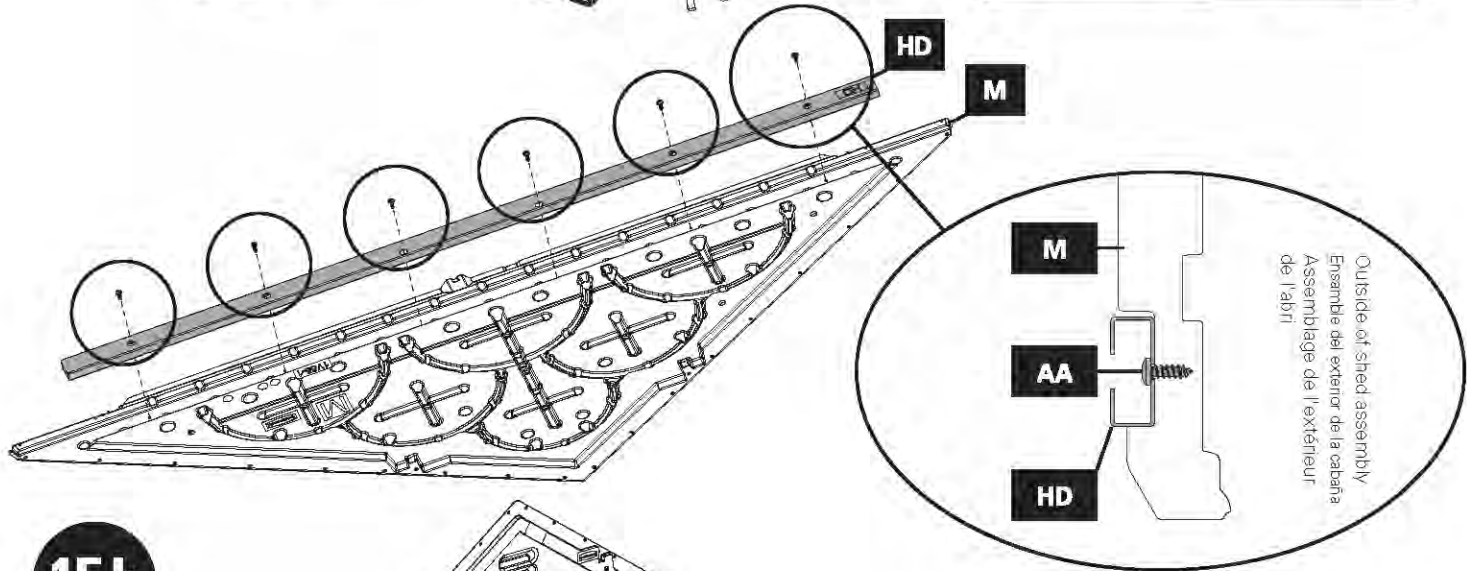
# 15b

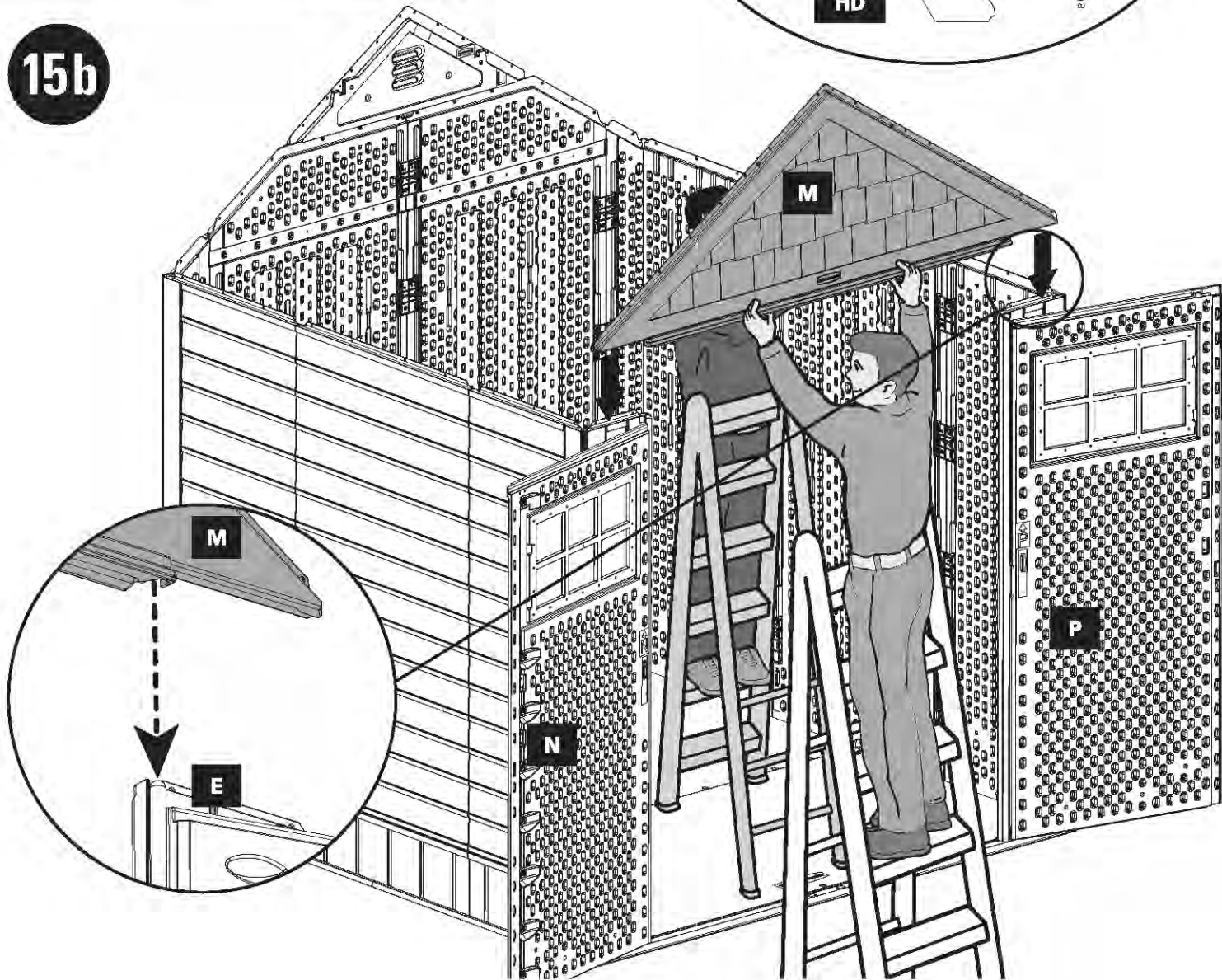

15c

AA 4



**DO NOT**  
overtighten screws!  
*(NO ajuste los tornillos en exceso!)*  
**ÉVITEZ**  
de trop serrer les boulons!

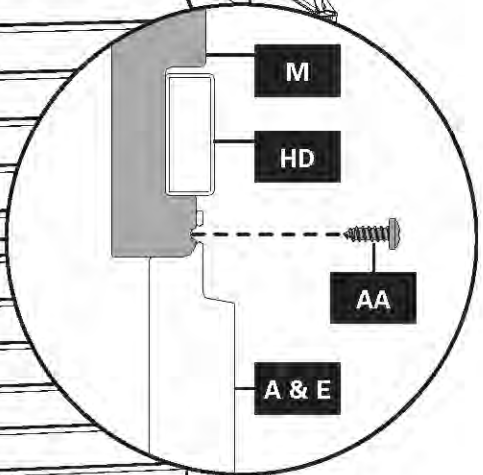
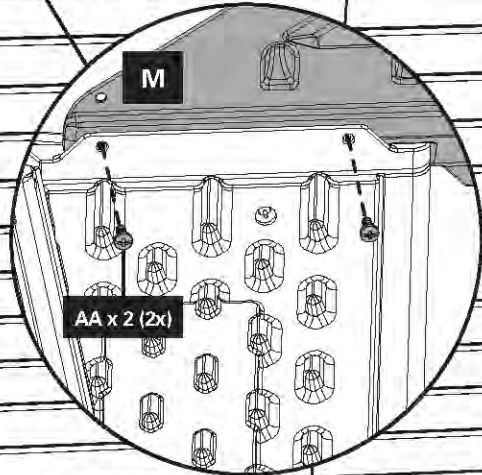
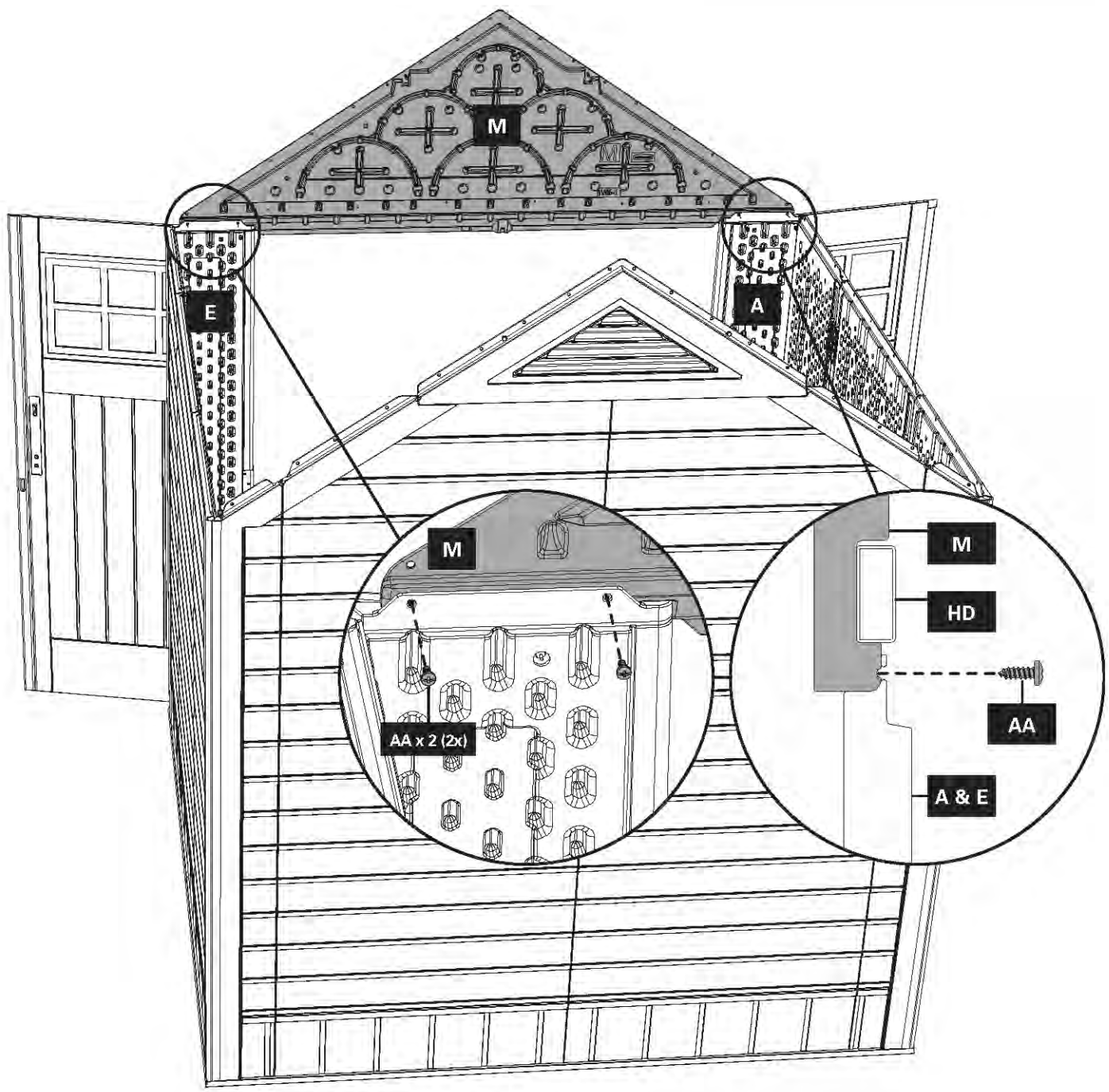

# 16a

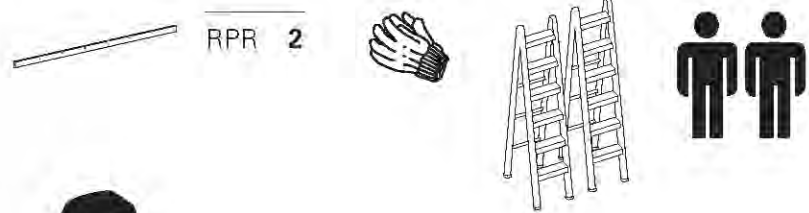

Front and back installation are the same.

La instalación del frente y de la parte trasera son iguales.

Les installations avant et arrièresont les mêmes.

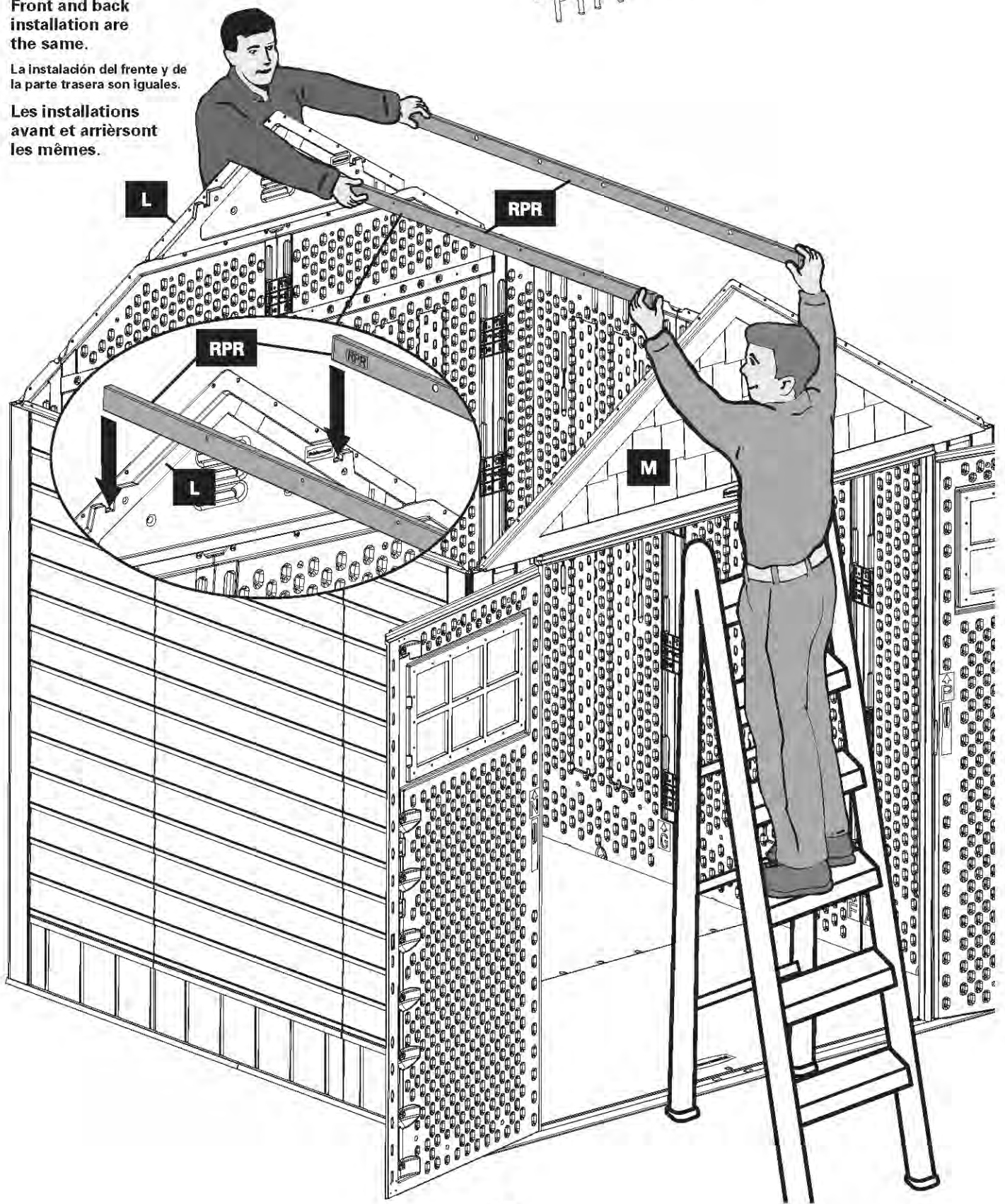



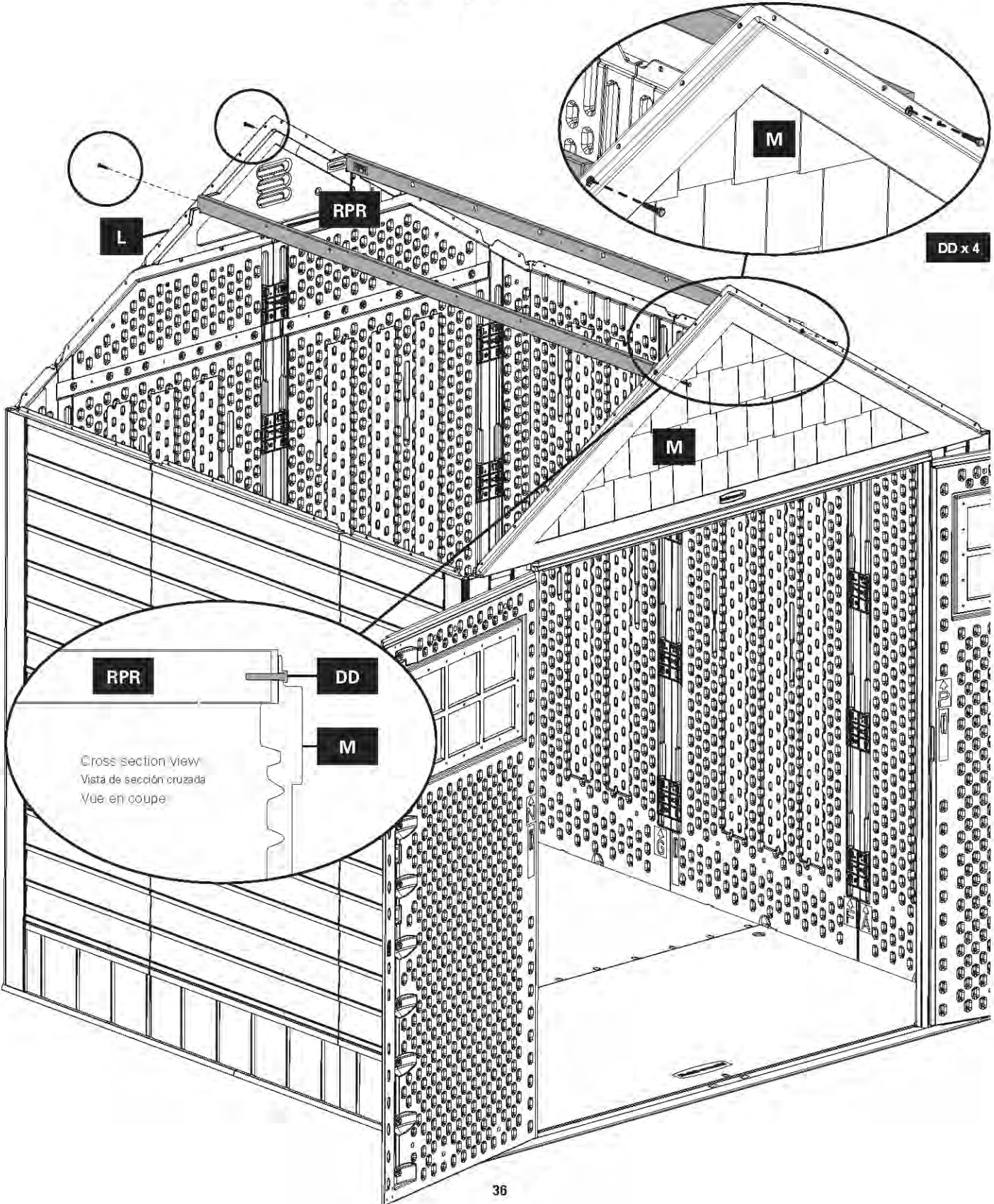





16b



Cross section view  
Vista de sección cruzada  
Vue en coupe

**17a**

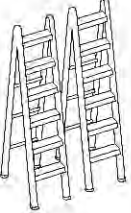
- |   |     |   |
|---|-----|---|
|  | DD  | 2 |
|  | EE  | 2 |
|  | CT  | 1 |
|  | CTB | 4 |
|  | GG  | 2 |
-   
  
  

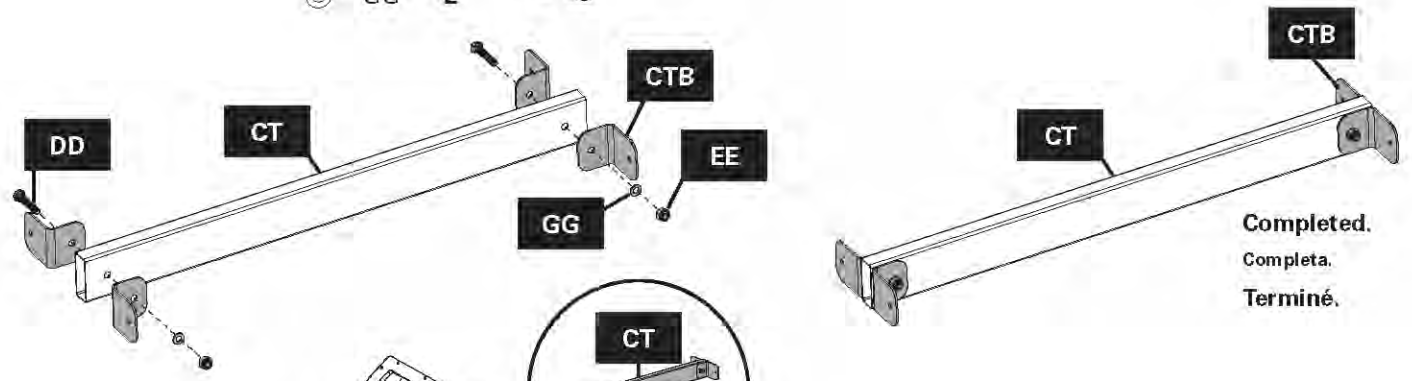

**17b**

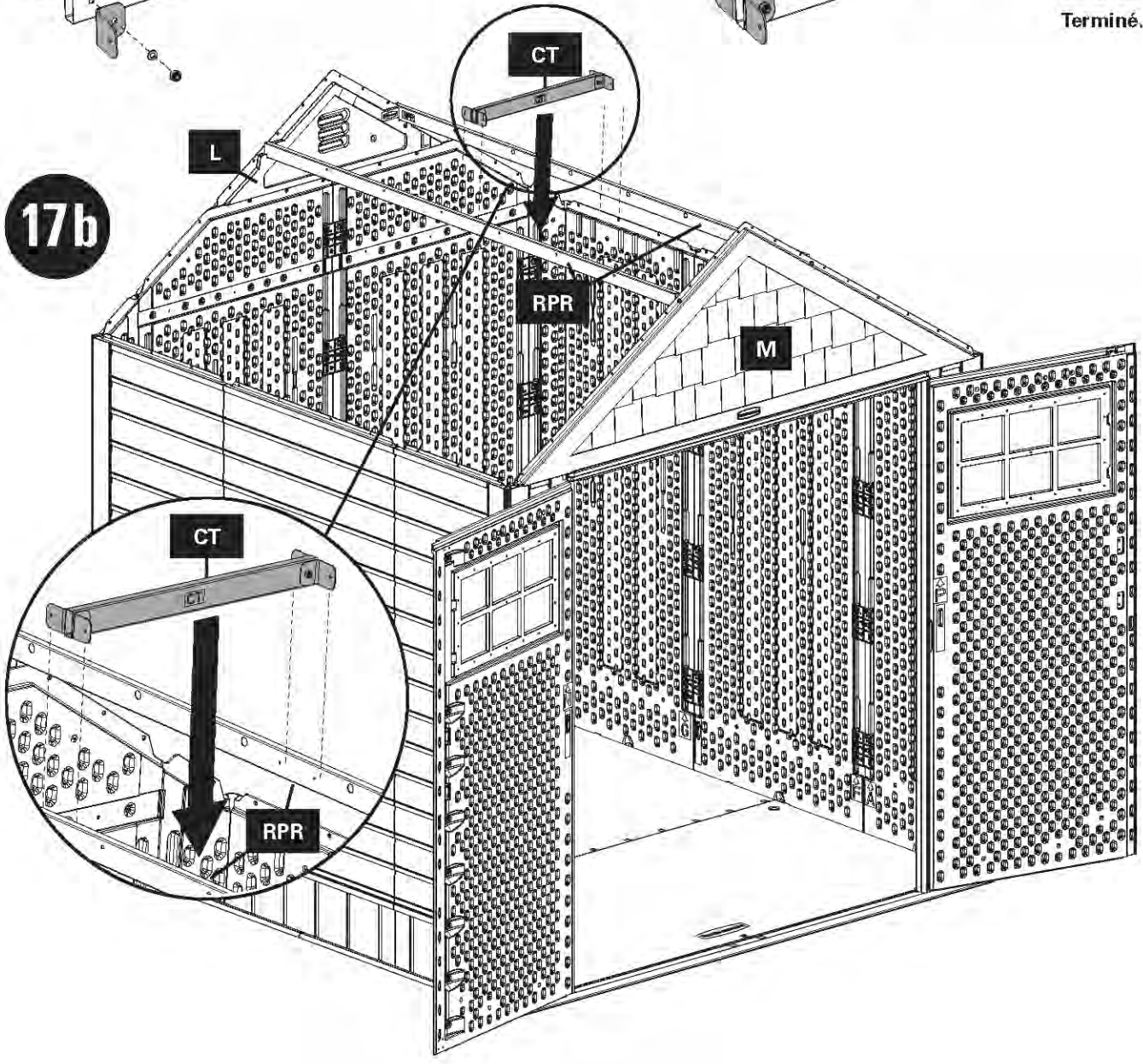

17c

① FF 4



**DO NOT**  
overtighten screws!  
(NO ajuste los tornillos en exceso!)  
**ÉVITEZ**  
de trop serrer les boulons!

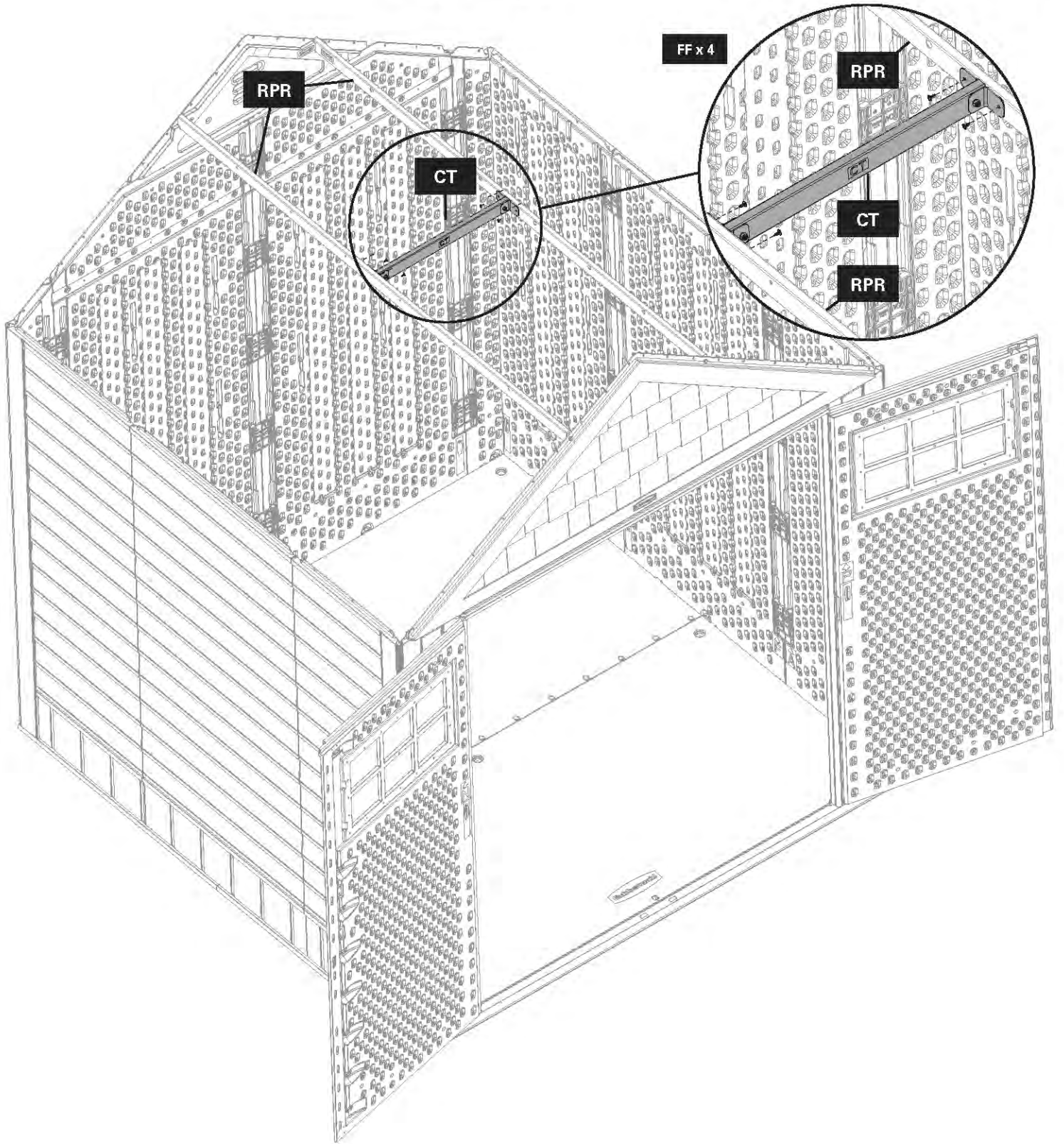

18a

HD 1

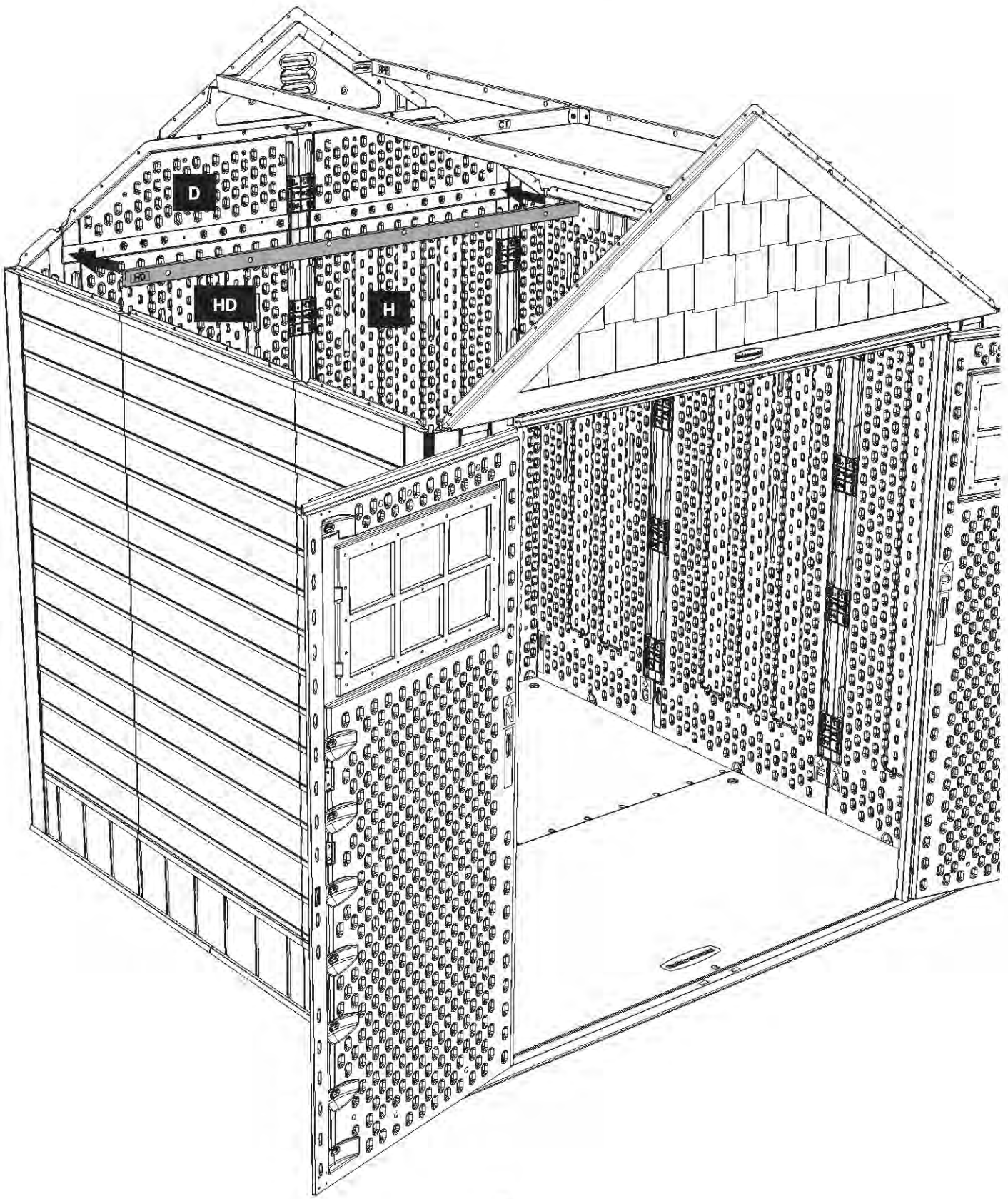
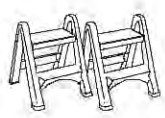

18b

AA 6



**DO NOT**  
overtighten screws!

(NO ajuste los tornillos en exceso)

**ÉVITEZ**  
de trop serrer les boulons!

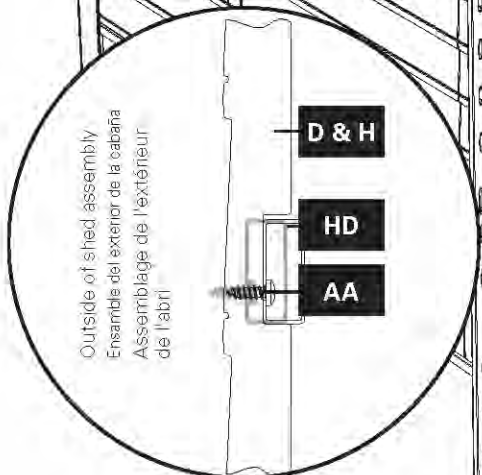
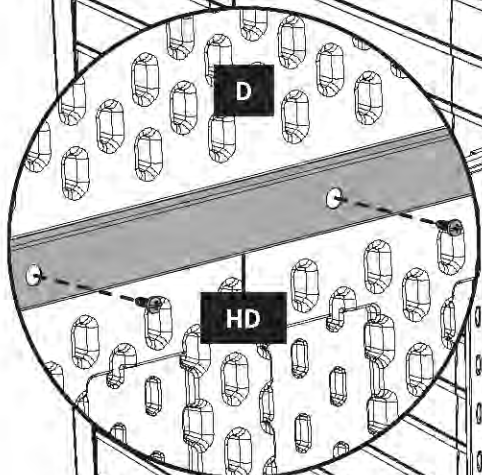
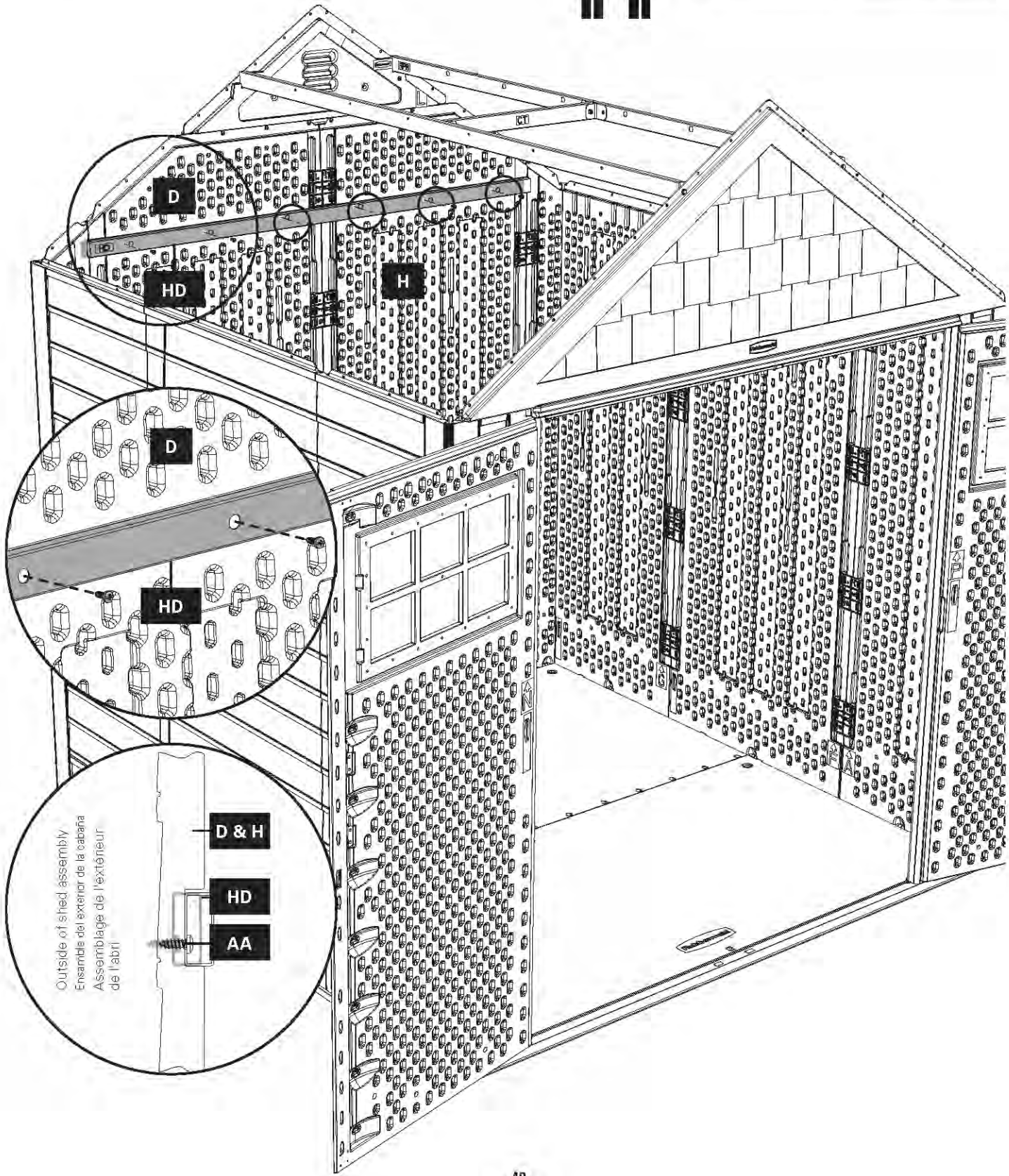

Outside of shed assembly  
Ensamble del exterior de la cabina  
Assemblage de l'extérieur  
de l'abri



19a



Q 2

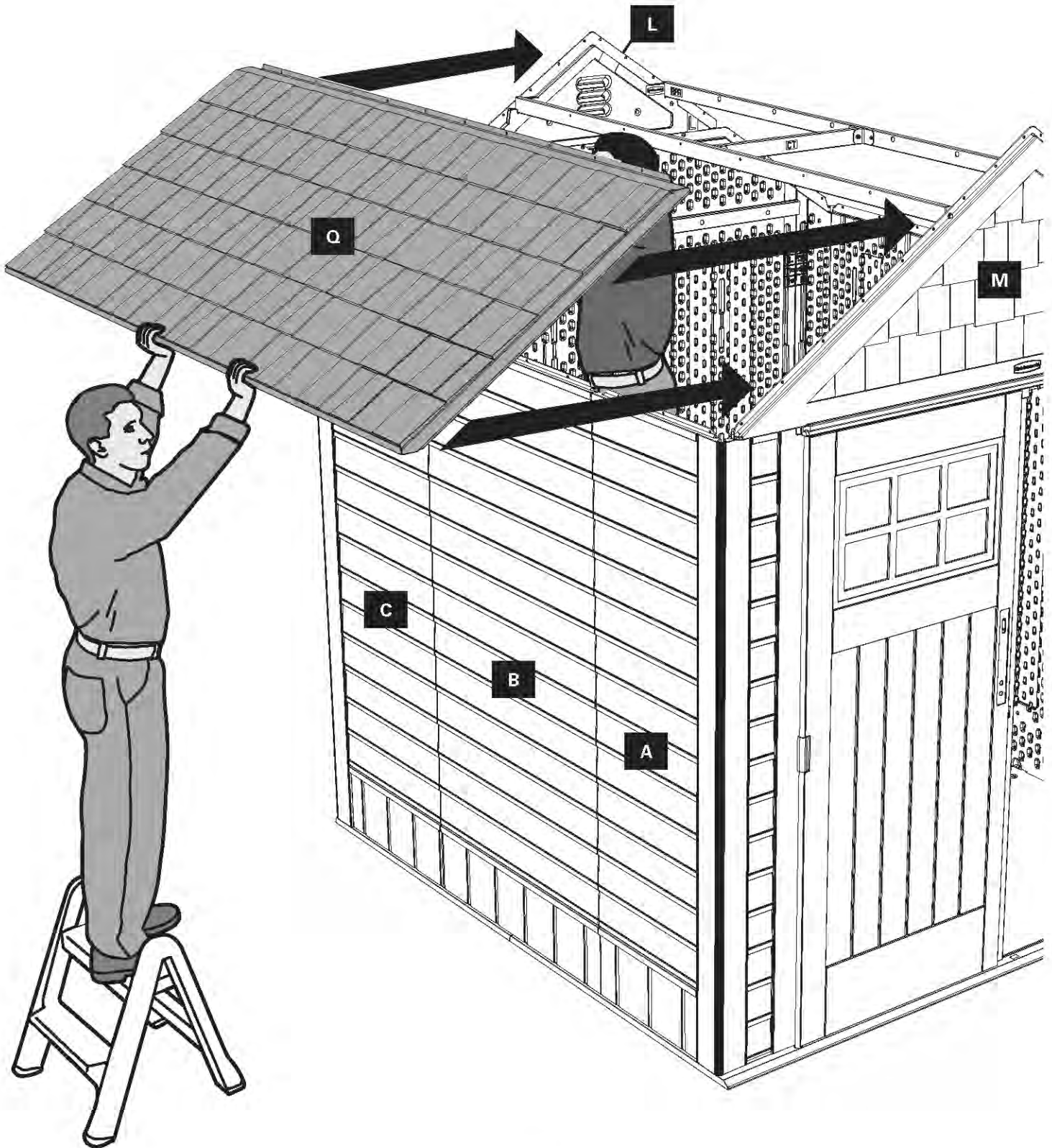
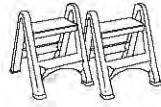

19b

AA 12

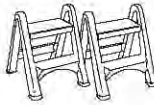

**DO NOT**  
overtighten screws!  
(NO ajuste los tornillos en exceso)

**ÉVITEZ**  
de trop serrer les boulons!

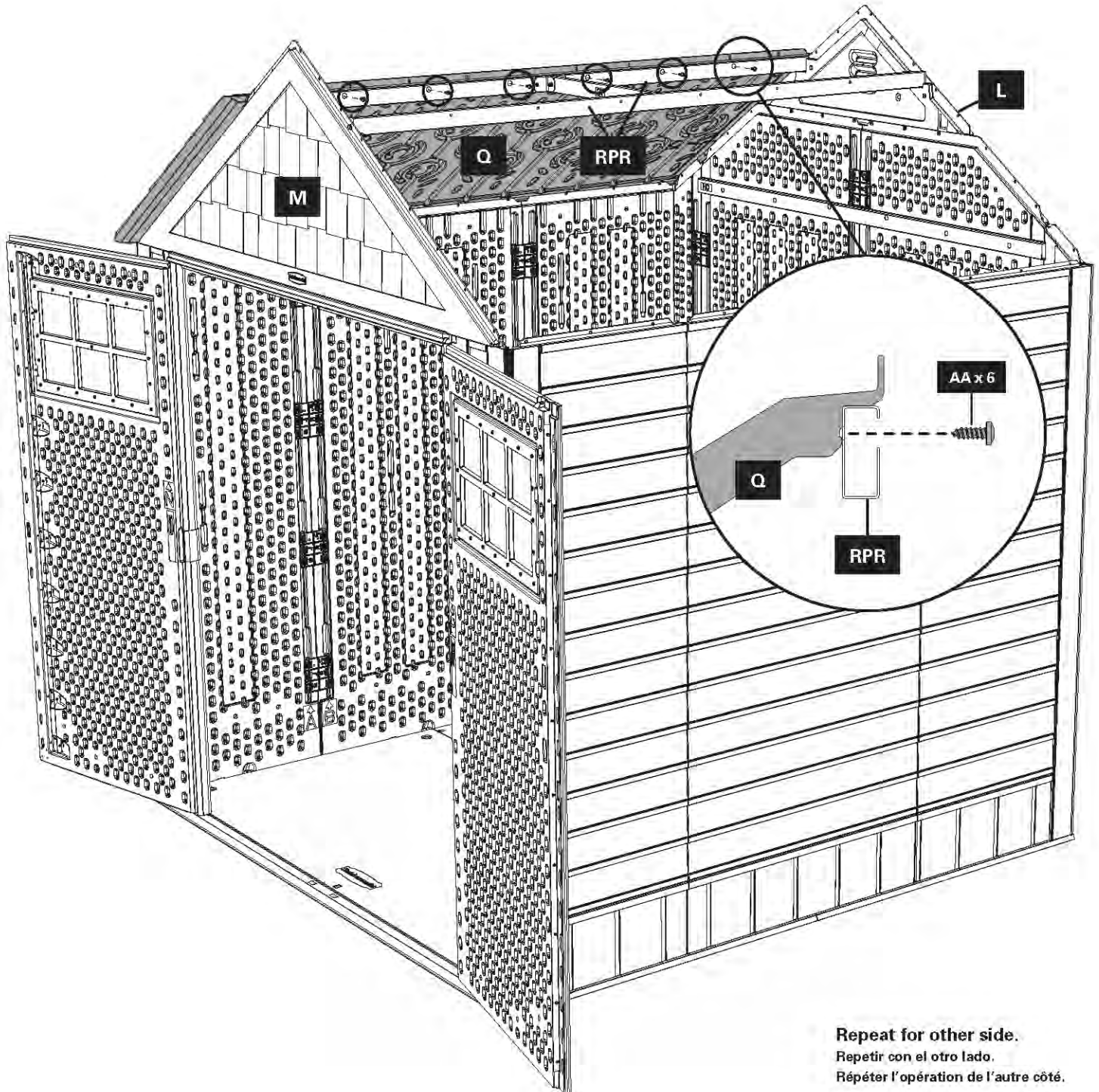

Repeat for other side.  
Repetir con el otro lado.  
Répéter l'opération de l'autre côté.

20a

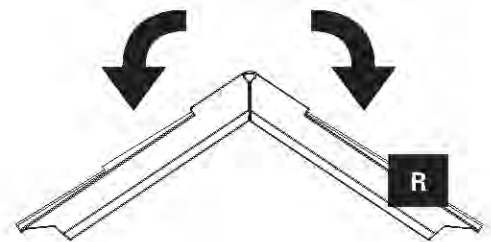
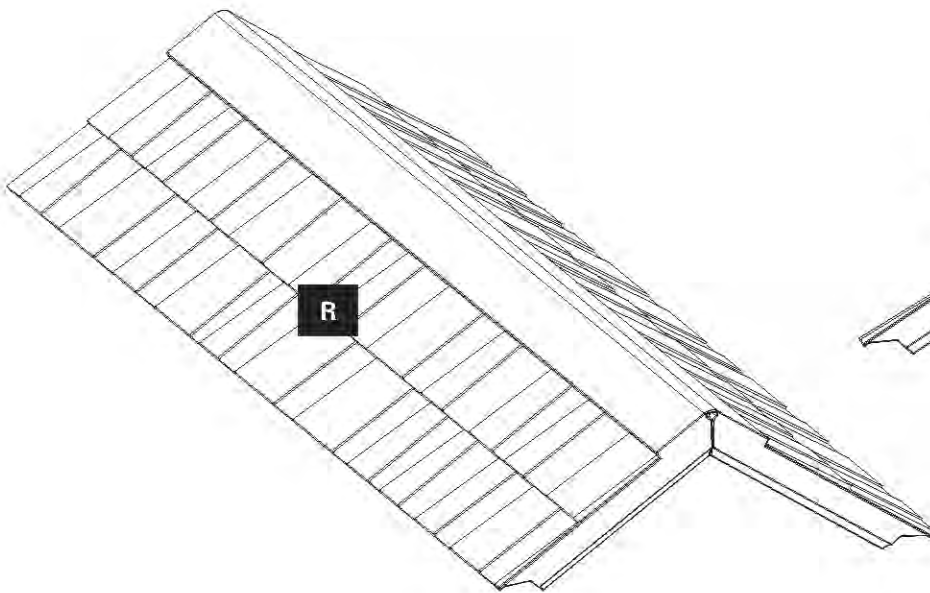
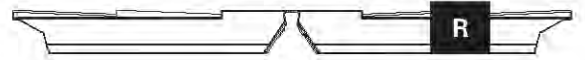
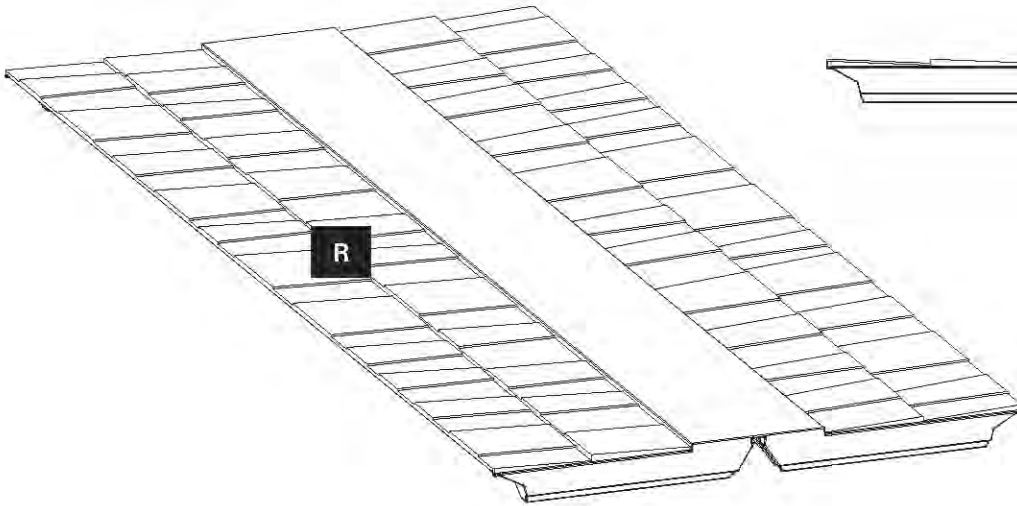



20b

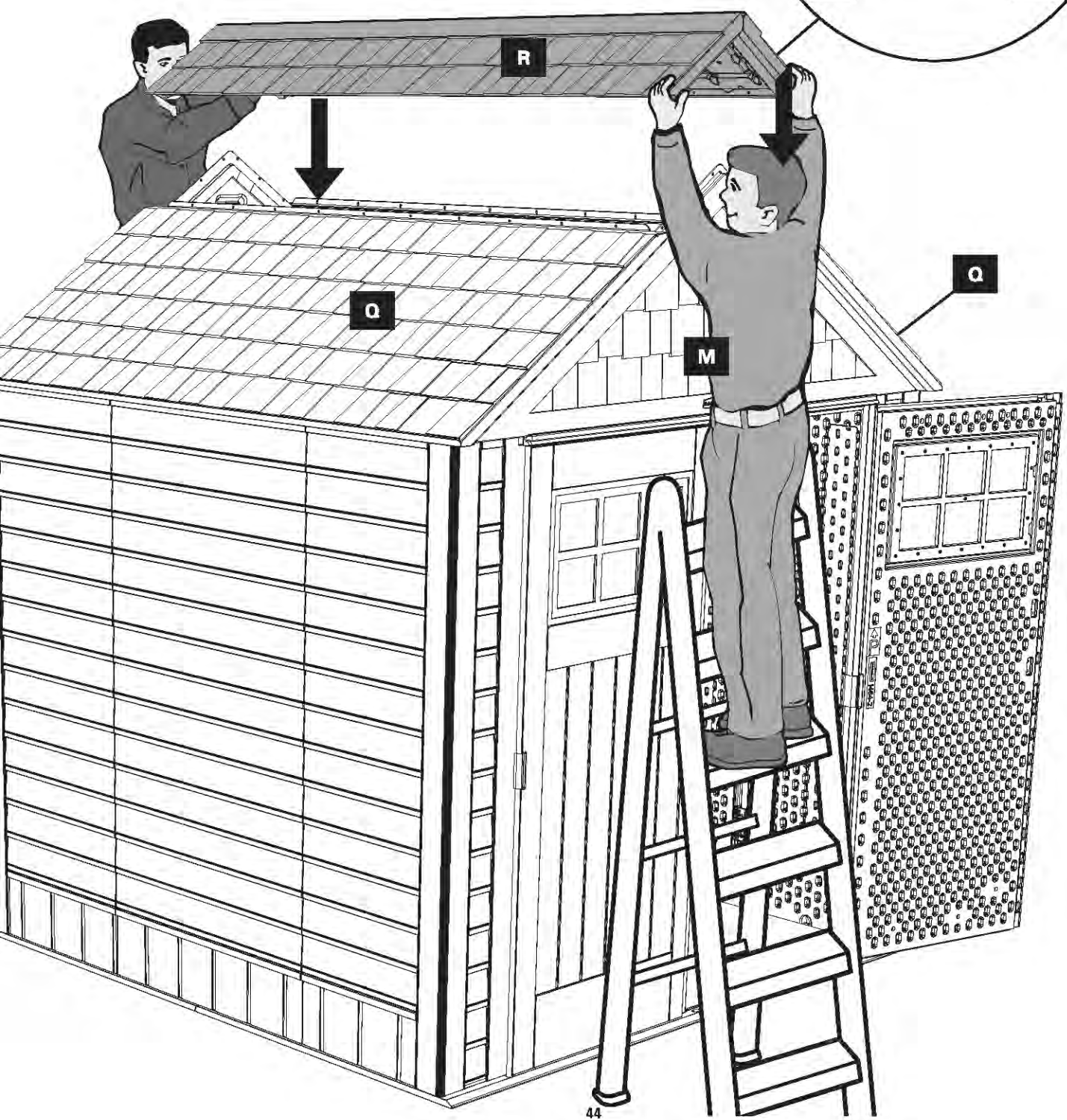
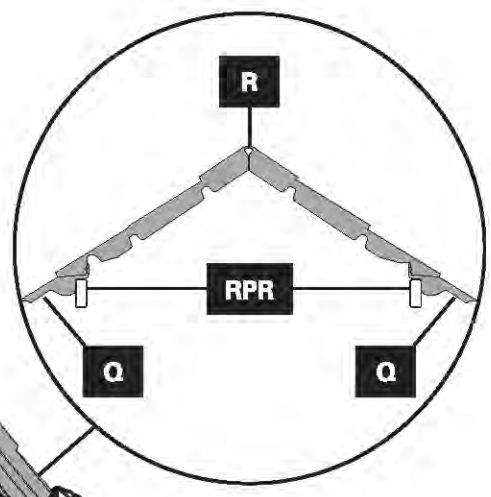
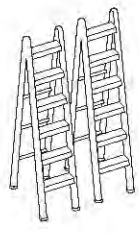

R 1



**20c**

- 
**FF** 4 per side  
 4 por lado  
 4 de chaque côté
- 
**RPN** 4 per side  
 4 por lado  
 4 de chaque côté

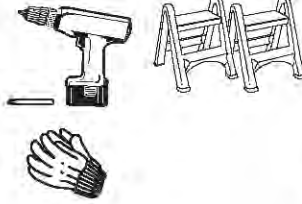

**DO NOT**  
overtighten screws!  
(NO ajuste los tornillos en exceso)

**ÉVITEZ**  
de trop serrer les boulons!

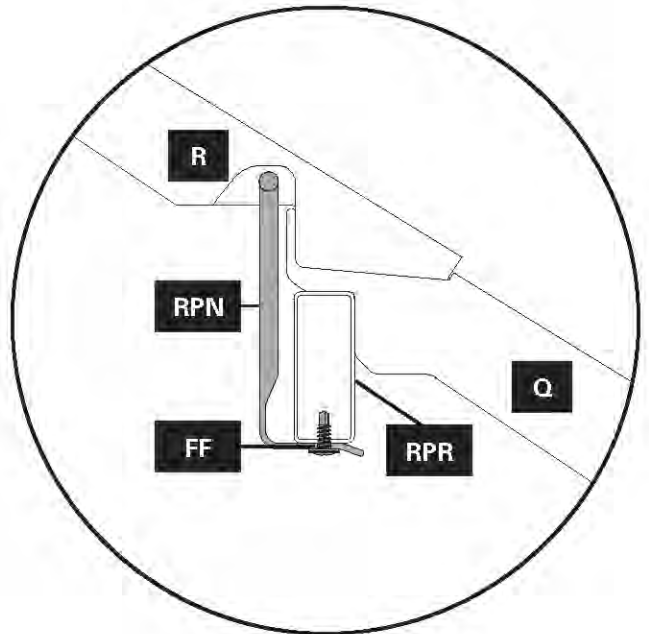
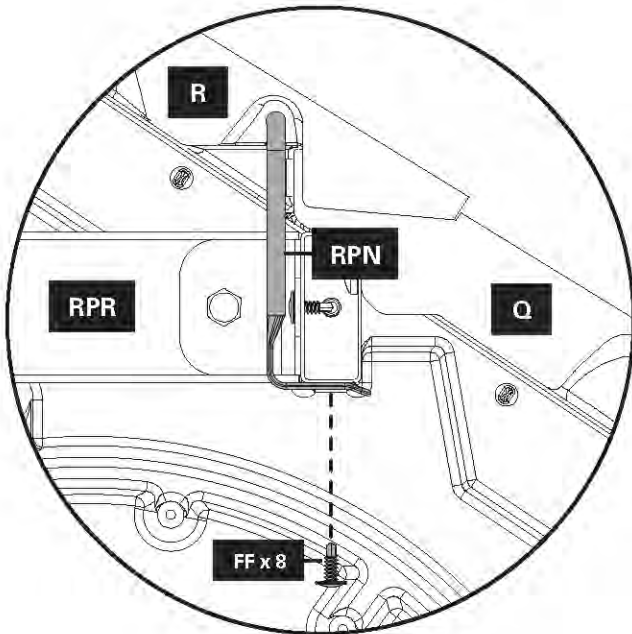
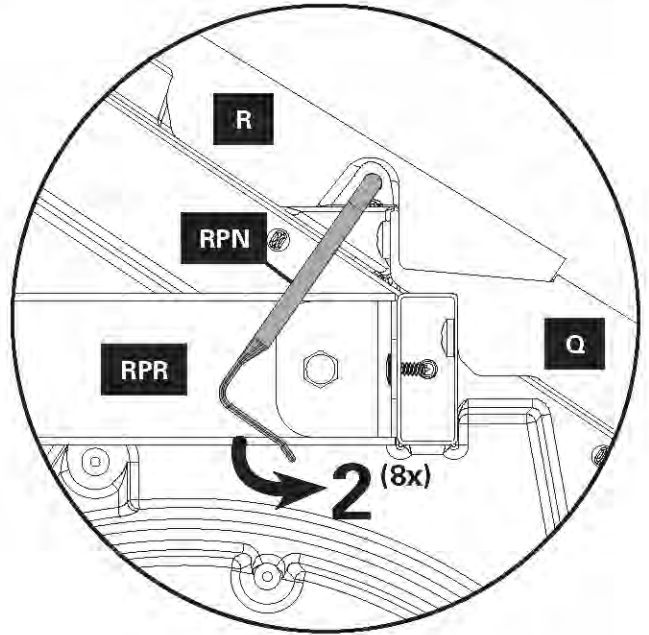
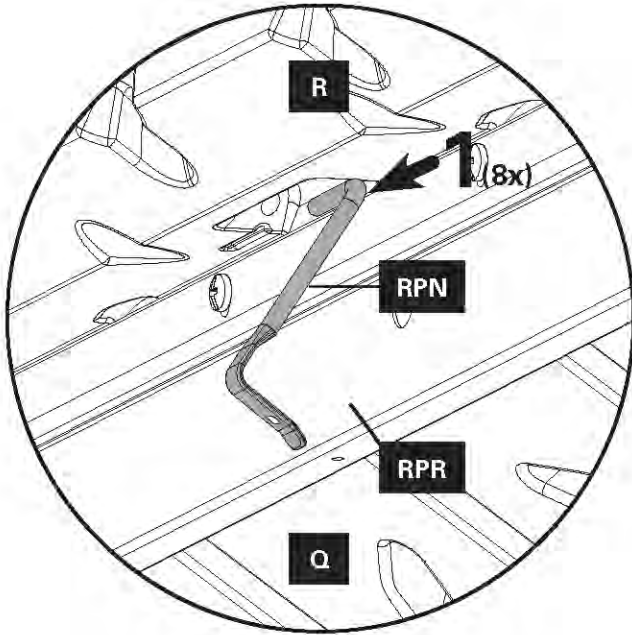
RPN in place (repeat 7x)  
 RPN en posición (repetir 7 veces)  
 RPN en place (répéter 7x)

RPN installation complete  
 Instalación completa de RPN  
 L'installation RPN est terminée

20d

AA 20



**DO NOT**  
overtighten screws!  
(NI ajuste los tornillos en exceso)

**ÉVITEZ**  
de trop serrer les boulons!

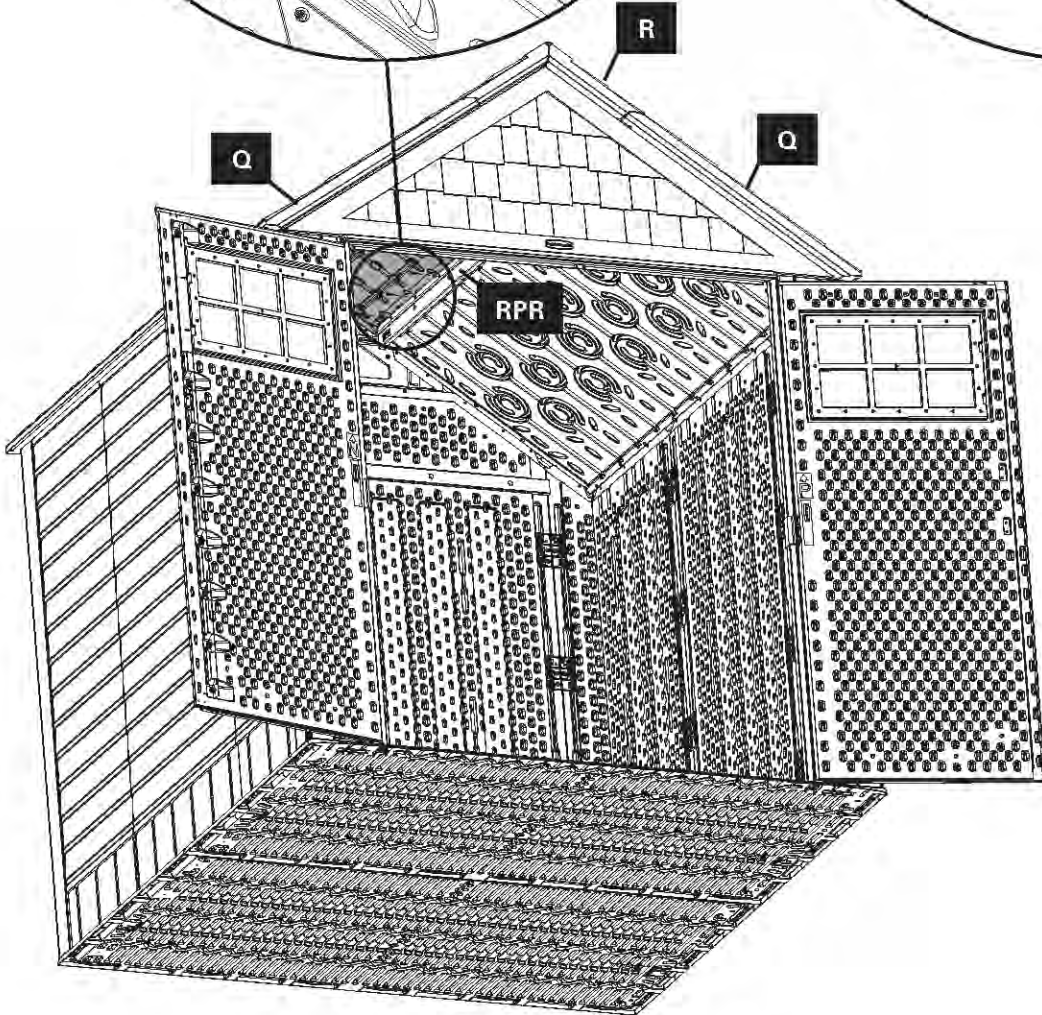
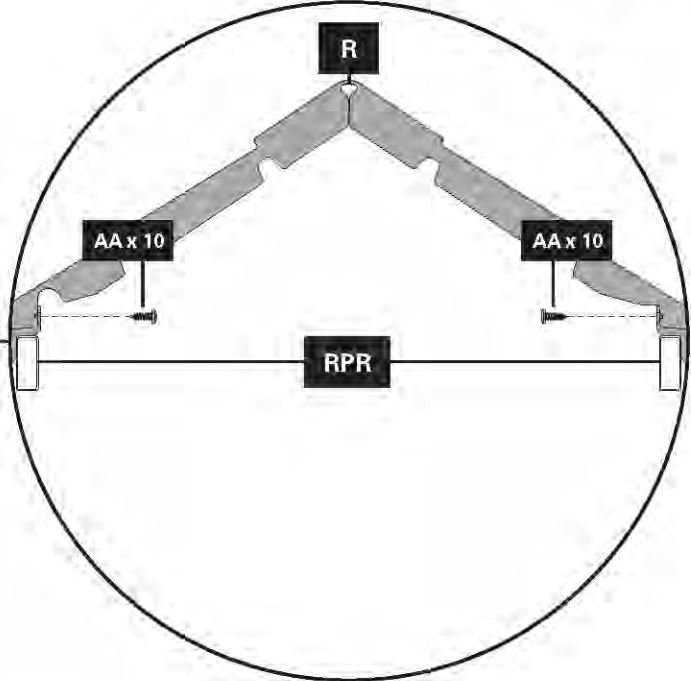
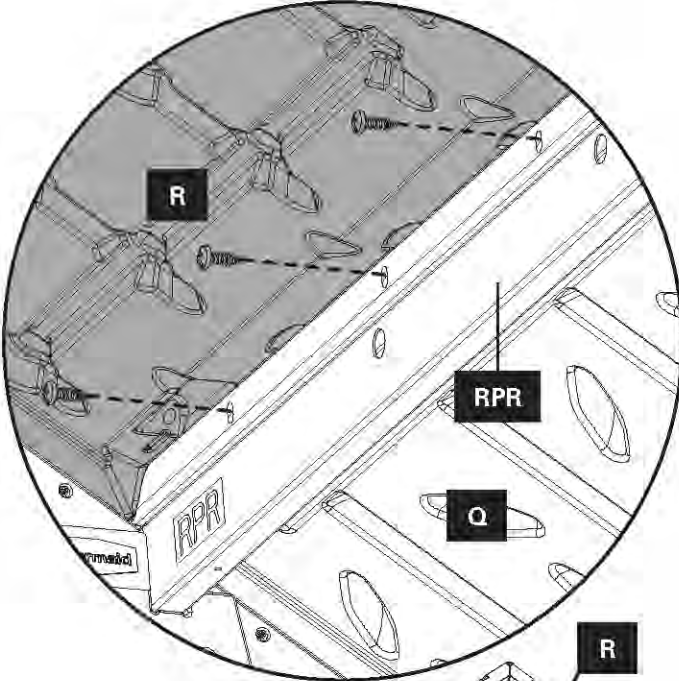

21

AA 56

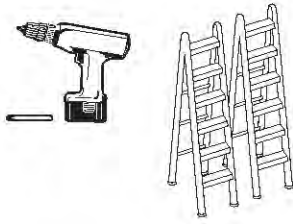

**DO NOT**  
overtighten screws!  
(NO ajuste los tornillos en exceso!

**ÉVITEZ**  
de trop serrer les boulons!

A warning symbol consisting of a large exclamation mark inside a triangle, with a small 'X' at the bottom, indicating a critical instruction.

**Anchor roof perimeter to walls and gables.**  
Fijar el perímetro del techo en las paredes y los gabletes.  
Ancrer le pourtour du toit aux murs et aux pignons.

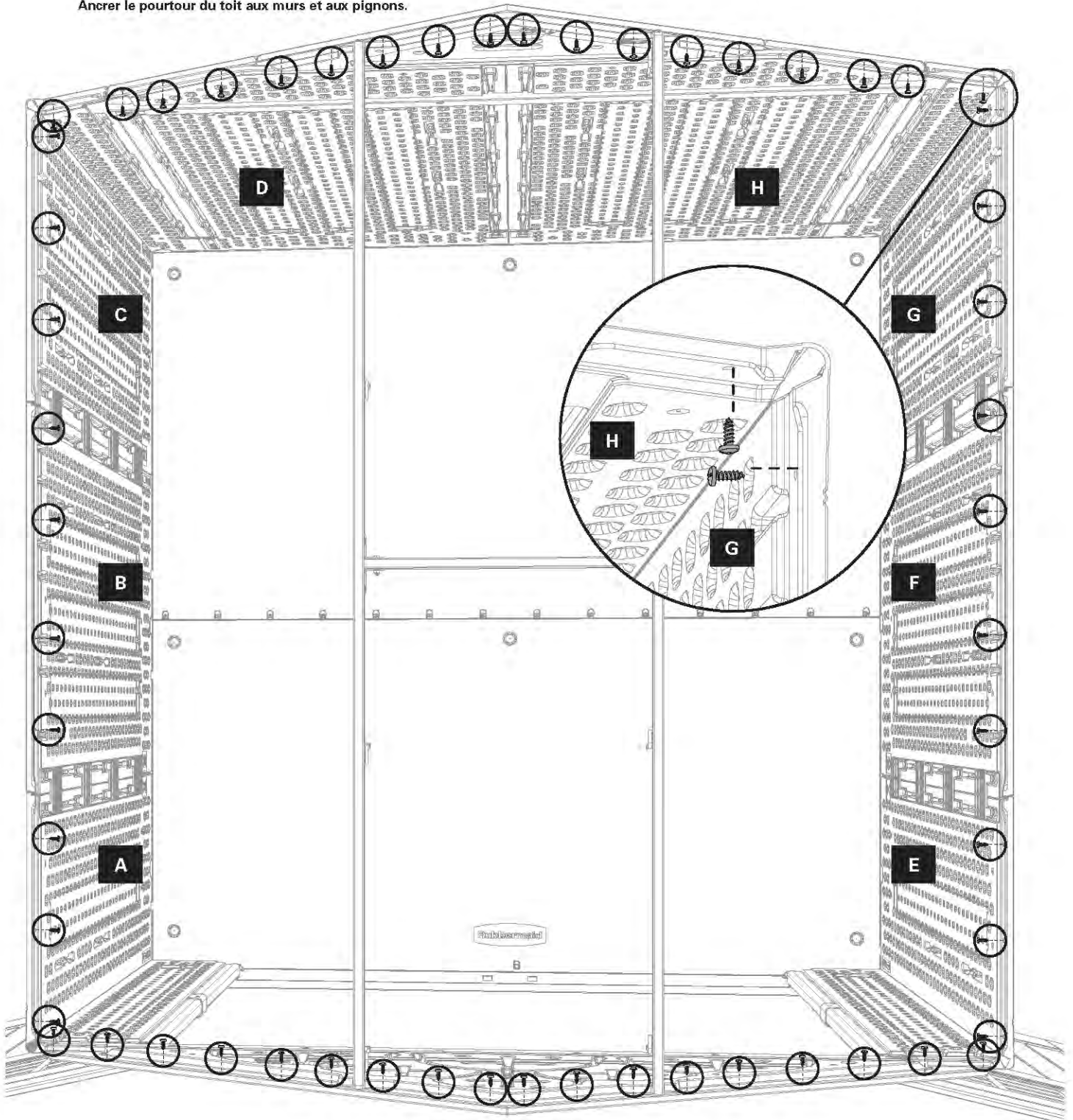

Continued.  
 Continúa.  
 Suite.

**Additional images.**

Imágenes adicionales.

Images supplémentaires.

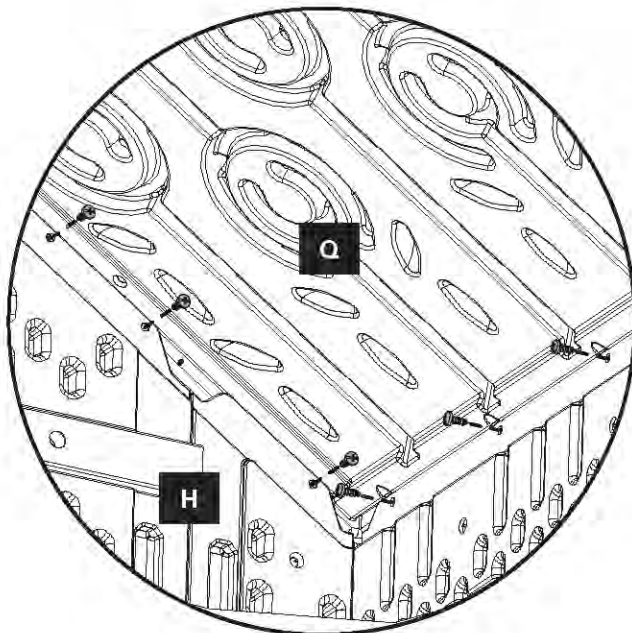
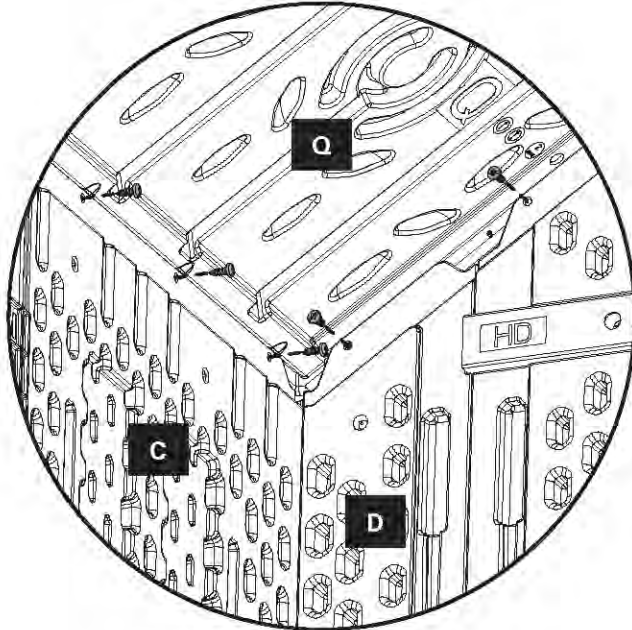

**Additional section images.**

Imágenes de sección adicionales.

Images de coupes supplémentaires.

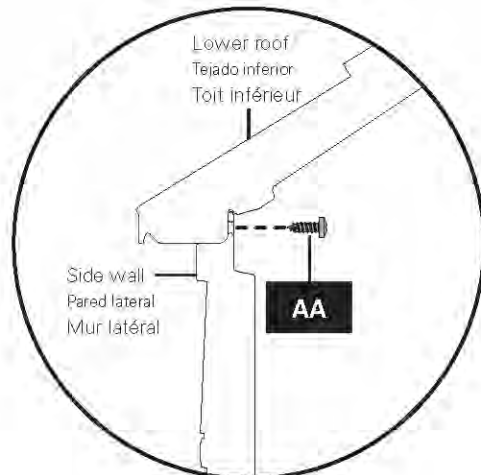
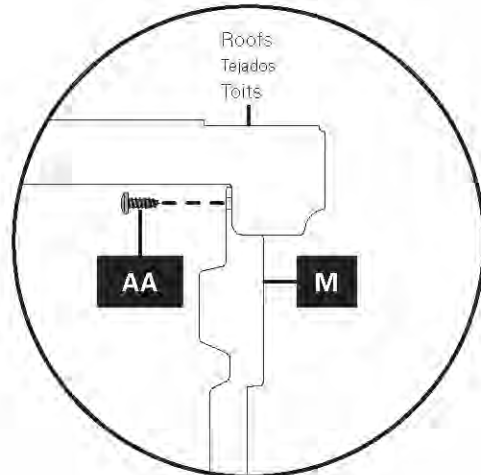
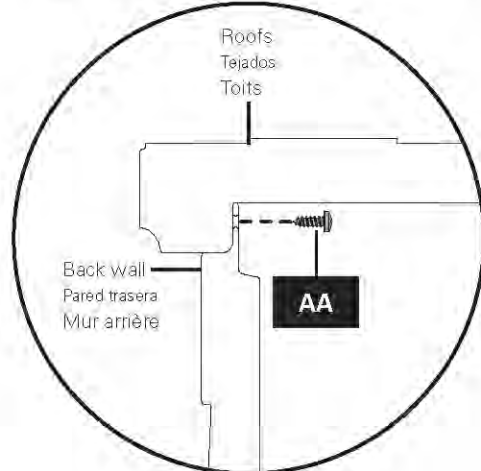



22a

- KK 2
- ← N 1
- TL 1
- EE 2

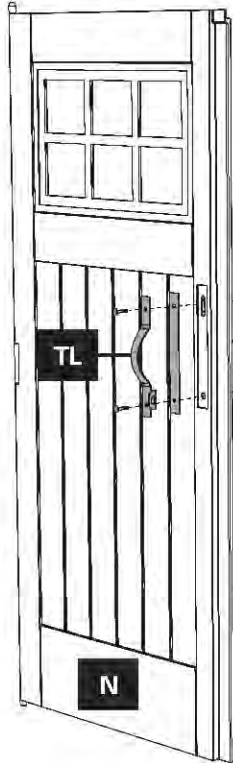

**DO NOT**  
overtighten screws!  
*(NO ajuste los tornillos en exceso!)*  
**ÉVITEZ**  
de trop serrer les boulons!

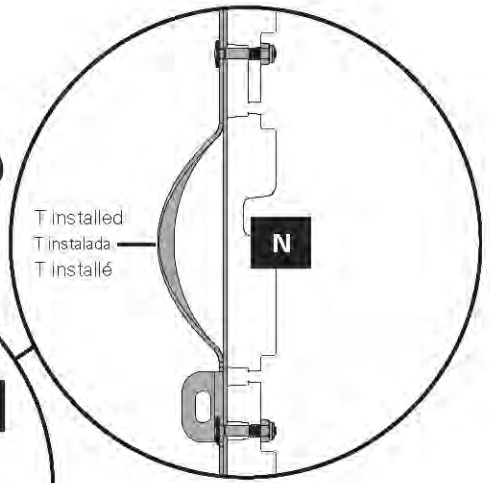
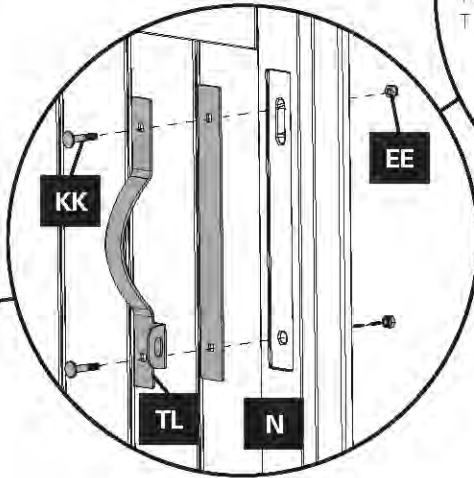

22b

- KK 2
- ← P 1
- TR 1
- EE 2

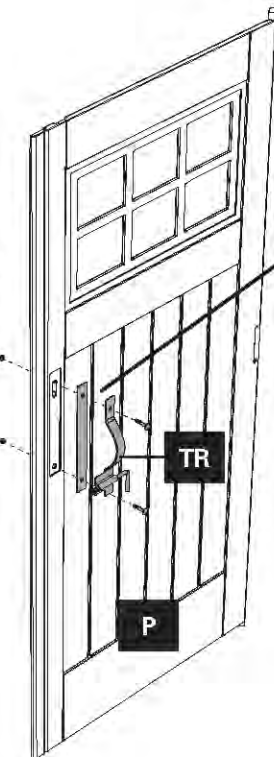

**DO NOT**  
overtighten screws!  
*(NO ajuste los tornillos en exceso!)*  
**ÉVITEZ**  
de trop serrer les boulons!

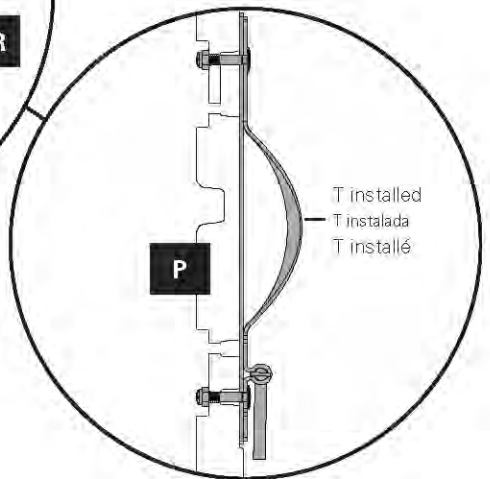
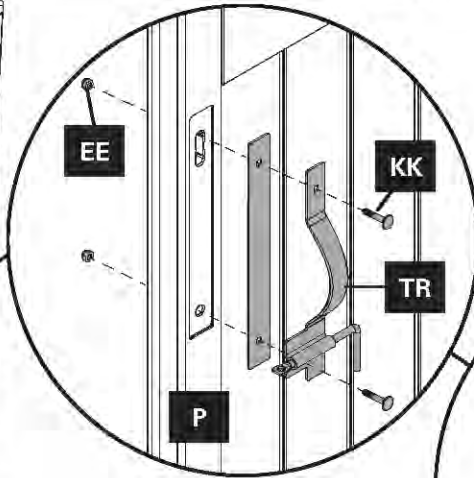

23

AA 12



**DO NOT**  
overtighten screws!  
¡NO ajuste los tornillos en exceso!  
**ÉVITEZ**  
de trop serrer les boulons!

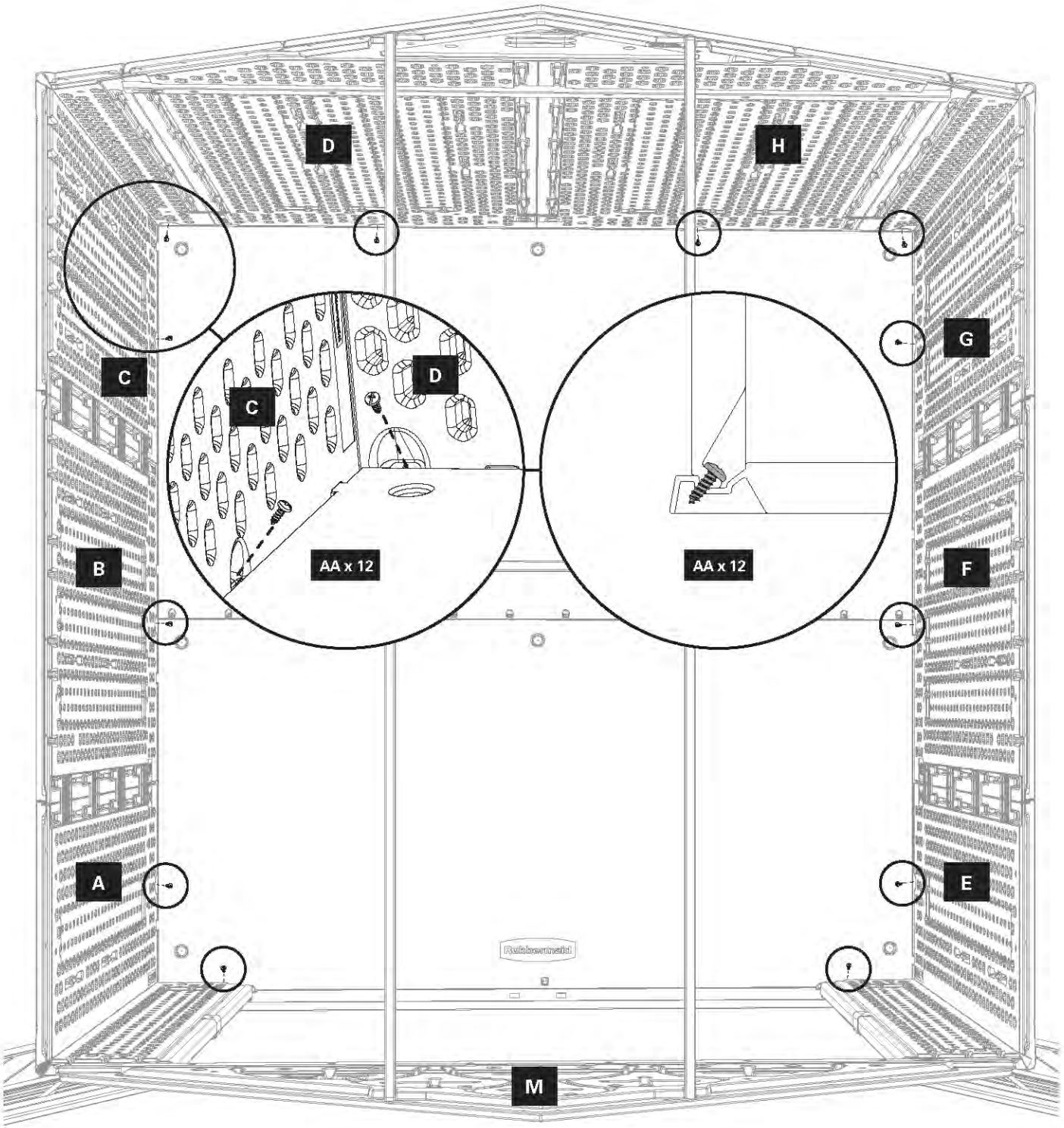

## Maintenance & Safety

- Periodically check storage building to ensure it remains stable and the site remains level.
- In areas of extreme high winds it is recommended to anchor storage building to platform or ground by drilling holes in the floor at designated location and secure with the proper fasteners (not included).
- Wash storage building with a garden hose or a mild detergent. Do not use abrasive detergents, materials or cleaning tools.
- Hot items such as recently used grills or fire pits should not be stored in the building.
- Heavy items should not be leaned against the walls, as this may cause distortion.
- Keep doors closed and secured when not in use to prevent wind damage.
- To maximize your product's performance, remove excessive snow and debris accumulation from the roof.
- Do not climb onto roof.
- Storage building is not designed for habitation.

## Mantenimiento y seguridad

- Periódicamente revise el cobertizo para asegurarse de que permanece estable y el sitio sigue estando nivelado.
- En áreas de fuertes vientos se recomienda anclar el cobertizo a una plataforma o al suelo, haciendo perforaciones en el piso en lugares indicados y asegurarlo con los bulones apropiados (no incluidos).
- Limpie el cobertizo con una manguera de jardín o un detergente suave. No utilice detergentes, materiales o herramientas de limpieza abrasivas.
- No debe almacenar en el cobertizo elementos calientes como braseros o parrillas recién usados.
- No deben apoyarse elementos pesados en las paredes, ya que esto podría provocar deformación.
- Mantenga las puertas cerradas y sujetas cuando no use el producto para prevenir daños.
- Para maximizar su desempeño del producto, quite el exceso de nieve o la acumulación de escombros del techo.
- No debe treparse al techo.
- El cobertizo no está diseñado para ser habitado.

## Entretien et sécurité

- Il est recommandé de vérifier l'abri de temps en temps pour vous assurer qu'il demeure stable et que le site reste à niveau.
- Dans les zones de vents puissants, il est recommandé d'ancrer l'abri à une plateforme ou au sol, en perçant des trous dans le plancher aux endroits désignés et de fixer avec des attaches appropriées (non fournies).
- Il est recommandé de laver l'abri de rangement avec un tuyau d'arrosage ou un détergent doux. Ne pas utiliser de détergents abrasifs, du matériel ou des outils de nettoyage.
- Les objets chauds comme les barbecues venant d'être utilisés ou les foyers ne doivent pas être rangés dans la remise.
- Les objets lourds ne doivent pas être appuyés contre un mur, car ils risqueraient de causer une déformation.
- Lorsque la remise n'est pas utilisée, gardez les portes fermées et verrouillées pour éviter tout dommage.
- Afin de prolonger la durée de vie de l'article, enlevez la neige et les débris qui s'accumulent sur le toit.
- Ne grimpez pas sur le toit.
- L'abri de rangement n'est pas conçu pour l'habitation.



visit [www.rubbermaid.com/outdoorliving](http://www.rubbermaid.com/outdoorliving) for helpful tips and information

---

visite [www.rubbermaid.com/outdoorliving](http://www.rubbermaid.com/outdoorliving) para información y consejos útiles

---

Visitez [www.rubbermaid.com/outdoorliving](http://www.rubbermaid.com/outdoorliving) pour des conseils pratiques et de l'information



**YOU'RE DONE!** Remember, if you have any trouble, don't call or return to the store. Call our Consumer Service Department at 1-888-895-2110 (Mon.–Fri. 8:30 a.m. to 5:00 p.m. EST). Keep this instruction booklet and your original store receipt to ensure our Consumer Service Department can accurately and quickly assist you.

---

**¡YA ESTÁ!** Recuerde, si tiene problemas, no llame a la tienda ni devuelva el producto. Llame a nuestro Departamento de Atención al Cliente al 1-888-895-2110 (de lunes a viernes, de 8:30 a. m. a 5:00 p. m. EST). Guarde este manual de instrucciones y la factura original de su tienda para garantizar que nuestro Departamento de Atención al Cliente pueda ayudarlo rápida y correctamente.

---

**TERMINÉ!** Rappel : si vous avez des difficultés, appelez au magasin ou retournez l'article. Appelez notre service aux consommateurs au 1-888-895-2110 (lun. au ven. de 8 h 30 à 17 h HNE). Veuillez garder le présent livret d'instructions et le reçu du magasin afin que notre service aux consommateurs puisse vous aider adéquatement.