

# User Manual

ATS- 907 | 908 | 909 | 1000

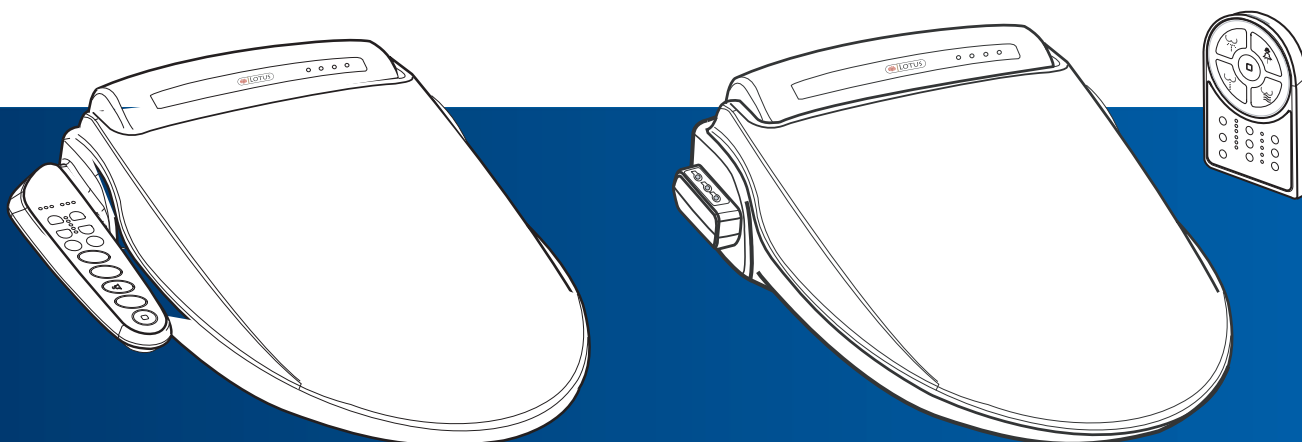

- This Product should be installed according to this manual.
- Please read this manual carefully and install properly.
- Please keep this manual for future reference.
- Please register Warranty for proper service.

**Supreme...**  
**HYGIENE AND COMFORT**

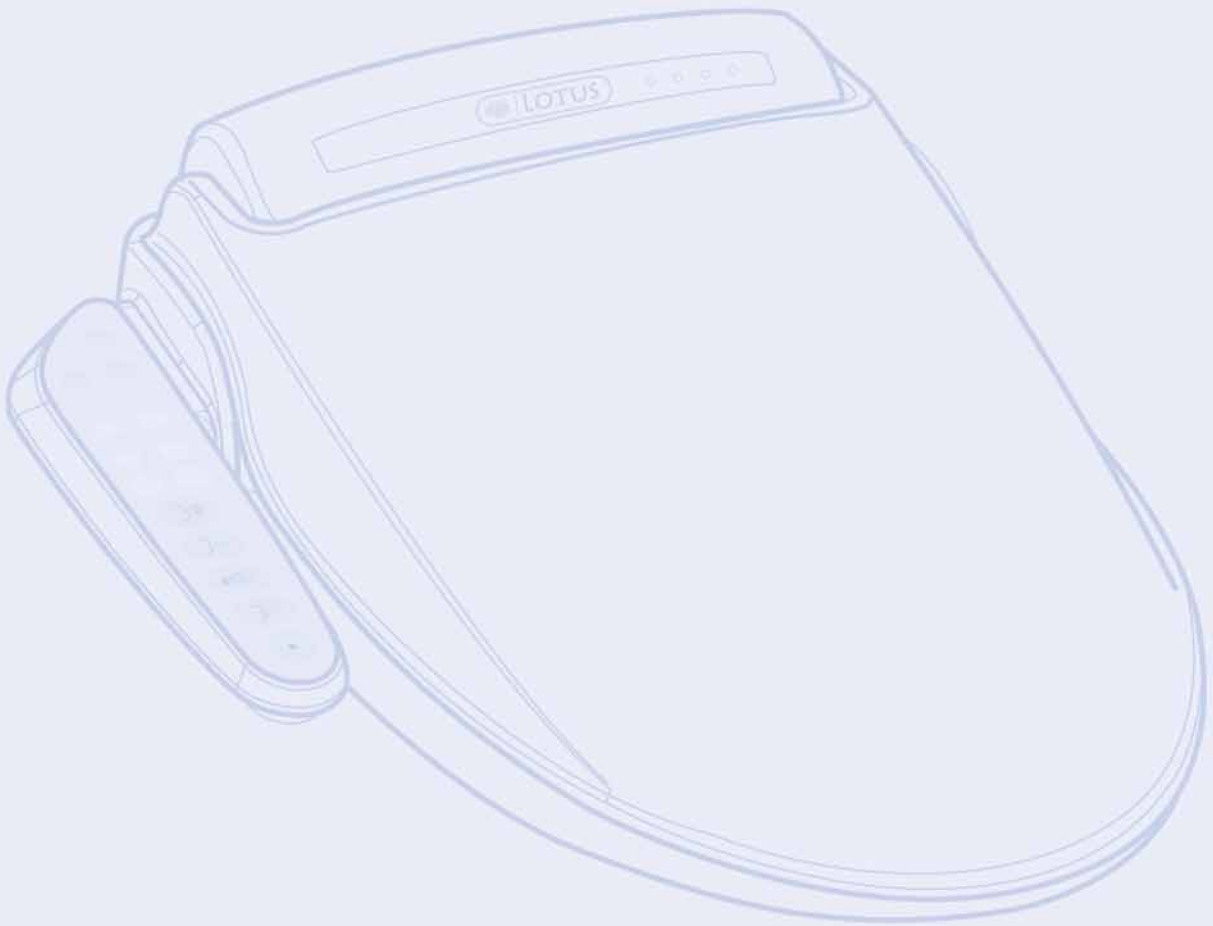

 LOTUS

# Contents

- IMPORTANT SAFEGUARDS / ..... 4
- GENERAL CAUTIONS
- CAUTIONS BEFORE INSTALLATION ..... 6

PREPARATION

- IDENTIFICATION ..... 8
- OPERATION (BASIC) ..... 9
- OPERATION (DETAILED) ..... 10

OPERATION  
907 - 908 - 909

- IDENTIFICATION ..... 14
- OPERATION (BASIC) ..... 15
- OPERATION (DETAILED) ..... 16

OPERATION  
1 000

- INSTALLATION ..... 20
- SEPERATION OF THE UNIT FROM  
THE TOILET BOWL ..... 23

INSTALLATION

- MAINTENANCE ..... 24
- WATER DRAINING ..... 25
- TROUBLE SHOOTING ..... 26
- SPECIFICATIONS ..... 27
- INFORMATION TO THE USER ..... 28
- WARRANTY ..... 29

MAINTENANCE

# 1

## IMPORTANT SAFEGUARDS/GENERAL CAUTIONS

### ● READ ALL INSTRUCTIONS BEFORE INSTALLATION AND USE

The following terms are used in this manual to indicate hazards of varying degrees of severity

<b>DANGER</b>	indicates an imminently hazardous situation which, if not avoided, will result in death or serious injury.
<b>WARNING</b>	indicates potentially hazardous situation which, if not avoided, could result in death or serious injury.
<b>CAUTION</b>	indicates potentially hazardous situation which, if not avoided, may result in minor or moderate injury or in damage to the product or other property.



**DANGER** - To reduce the risk of electrocution



**WARNING** - To reduce the risk of burns, electrocution, fire, or injury to persons



**PLEASE OBSERVE THE FOLLOWING PRECAUTION BEFORE USING THIS PRODUCT**



Do not dismantle

Do not open the product to repair or remodel. Only qualified service personnel should service this product. Do not use attachments not recommended by the manufacturer.



Prohibited

Do not connect to an industrial water supply line that does not carry water of drinking quality. This will negatively effect hygiene and performance.

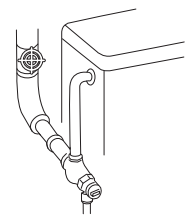

Prohibited

A low temperature burn may occur when the skin has been in contact with an object at relatively low temperature (about 104°F ). Close supervision is necessary when this product is used by, children or people with sensitive skin.



Prohibited

Do not use benzene or any acid chemical detergent. Only neutral detergents permitted.





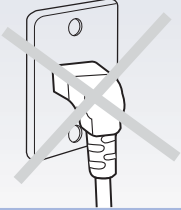

Do not plug in the power cord before connecting the water supply hose.



Prohibited



This product must be grounded before use. Refer to the grounding instructions on page 7. A Ground Fault Circuit Interrupt (GFCI) outlet is highly recommended.



Grounding

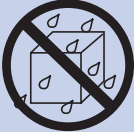

Do not splash water on this product. Please provide adequate ventilation to avoid damage to electronic components due to high levels of humidity.



Do not spray water



Do not touch the power cord with wet hands. Do not reach for a product that has fallen into water. Unplug immediately!

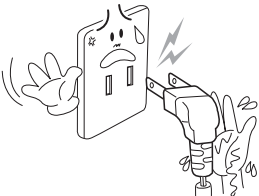

Wet hands prohibited



This product must be connected to a standard voltage power source. Do not connect power cord if the cord is damaged or broken. Do not plug the unit into a loose electric outlet.

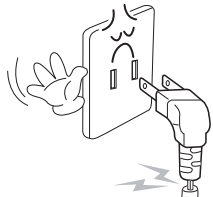

Observe at all times



Unplug the power cord when you detach this product from toilet bowl. Do not supply electrical power to the unit until the plumbing work has been completed.

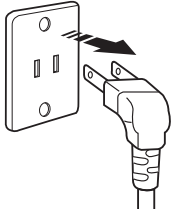

Observe at all times



Keep the cord away from heated surfaces. And keep any flammable materials away from this product.



Use of fire prohibited

# ⚠ CAUTION



Prohibited

Never operate this product if it is not working properly, if it has been dropped or damaged, or dropped into water. Return the product to a service center for examination and repair



Prohibited

Do not obstruct or put anything into the dry air outlet. Do not apply excessive force to the nozzle.



Prohibited

Do not stand or sit on the seat cover lid.



Prohibited

Allow the seat and lid to close automatically. Do not force the seat and lid.



Prohibited

Do not strain or pull the connected hose and tube connector; it may cause water leakage. Never drop or insert any object into any opening or hose. Use proper plumbing supplies if any modification is to be made.

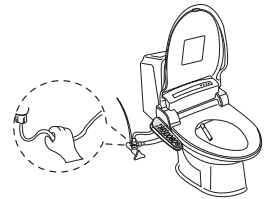

Observe at all times

Use this product only as described in the operating instructions.



Observe at all times

Use carefully to keep this product clean at all times.



Observe at all times

Drain the water from unit and unplug the power if it is not going to be used for an extended period of time. Refer to page 19.

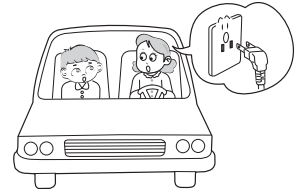

- SAVE THESE INSTRUCTIONS -

## 2

## CAUTIONS BEFORE INSTALLATION

### WIRING REQUIREMENT

THIS PRODUCT MUST BE PLUGGED into a regular voltage Grounded GFCI outlet (North America 120V AC, 60Hz / Europe 230V AC, 50Hz). The rated power consumption is 660W / 660W. In locations where only a standard two-prong outlet is available, it is the responsibility of the user to install a grounded three-prong outlet.

## GROUND INSTRUCTIONS

- (1) This product has a three-prong grounding plug, which must be plugged into an outlet that is properly installed and grounded. In the event of an electrical short circuit, grounding reduces the risk of electric shock by providing an escape wire for the electric current. If repair or replacement of the cord or plug is necessary, do not connect the grounding wire to either flat blade terminal. The wire with insulation having an outer surface that is green with or without yellow stripes is the grounding wire. Check with a qualified electrician or service man if the grounding instructions are not completely understood, or if in doubt as to whether the product is properly grounded.
- (2) This product is for use on a nominal 120V circuit, and has a grounding plug that looks like the plug illustrated in sketch A in Figure 1. A temporary adapter, which looks like the adapter illustrated in sketches B and C, may be used to connect this plug to a 2-pole receptacle as shown in sketch B if a properly grounded outlet is not available. The temporary adapter should be used only until a properly grounded outlet (sketch A) can be installed by a qualified electrician. The green colored rigid ear, lug, or the like extending from the adapter must be connected to a permanent ground such as a properly grounded outlet box cover. Whenever the adapter is used, it must be held in place by the screw.

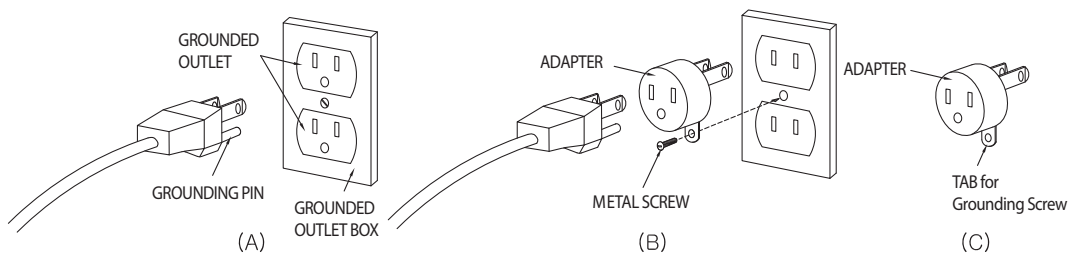

- Figure 1-

## OPTIONAL GROUND INSTRUCTIONS

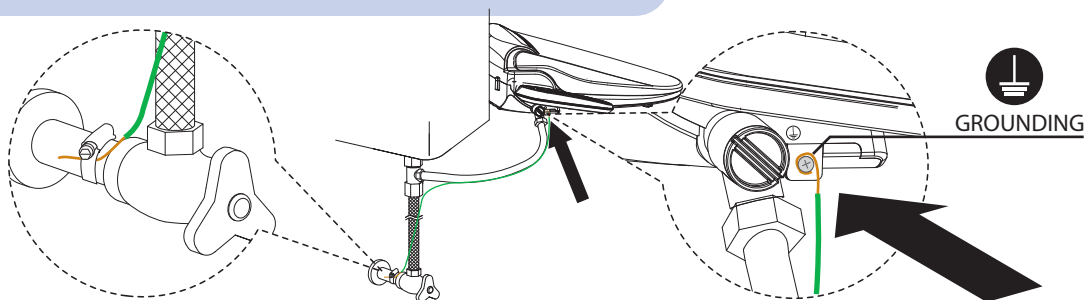

**⚠ DANGER**

IMPROPER GROUNDING CAN RESULT IN A RISK OF ELECTRIC SHOCK.

Electric wiring has to be done in accordance with all local codes, or in the absence of local codes, with the National Electrical Codes.

The use of an extension cord is not recommended or advised. If it is necessary to use an extension cord, use only a three-prong extension cord (one to one), and a three slot built-in GFCI receptacle that will accept the plug on this product. The marked rating of the extension cord should be equal to or greater than the electrical rating of the unit (10amp). Consult a qualified electrician or service person if you are not sure.

# 3

## IDENTIFICATION

### 1 MAIN UNIT

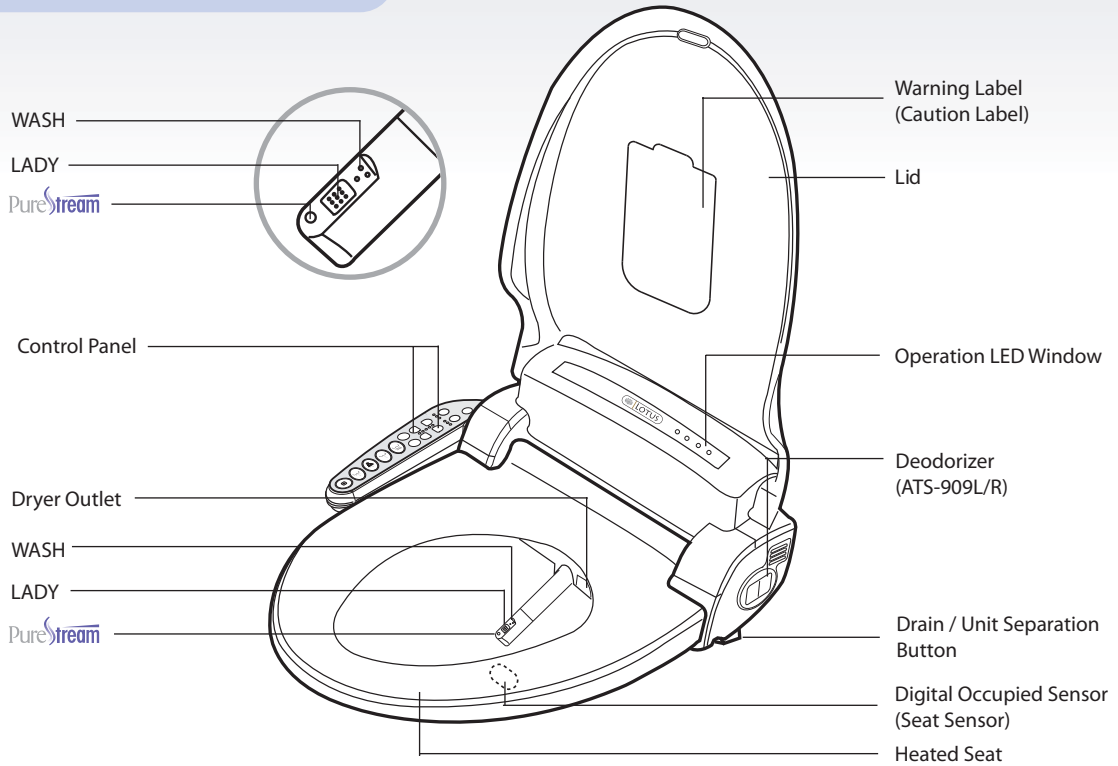

### 2 IN THE BOX

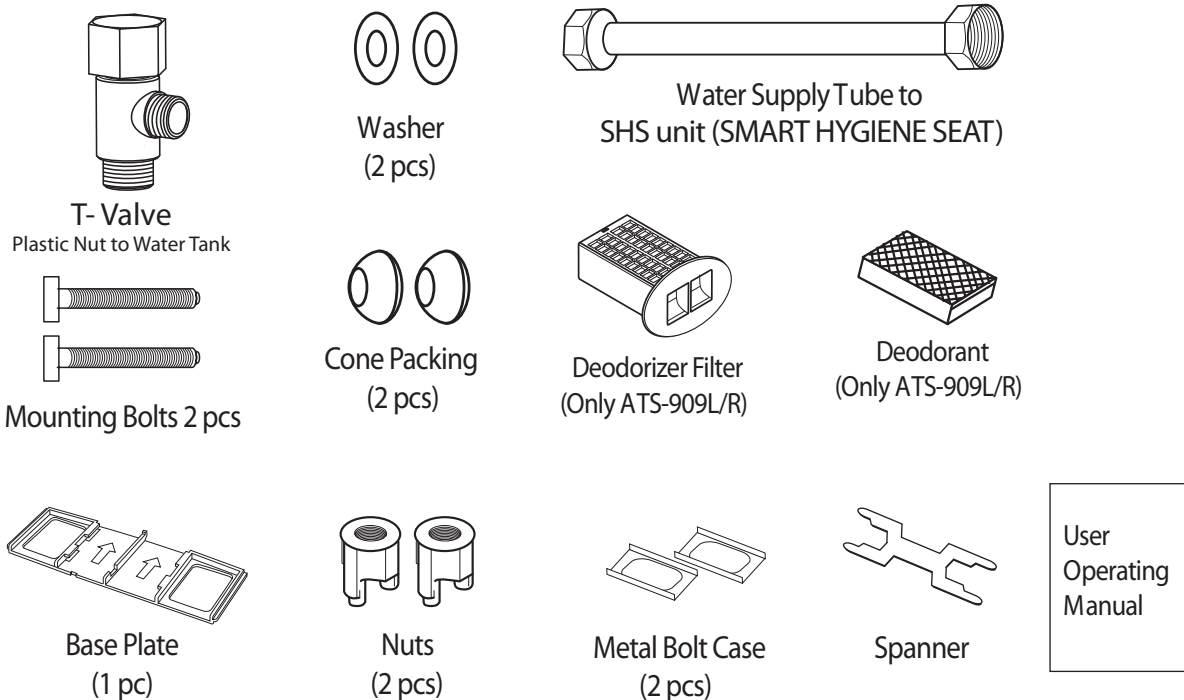



# 4 OPERATION (BASIC)

OPERATION  
907-908-909

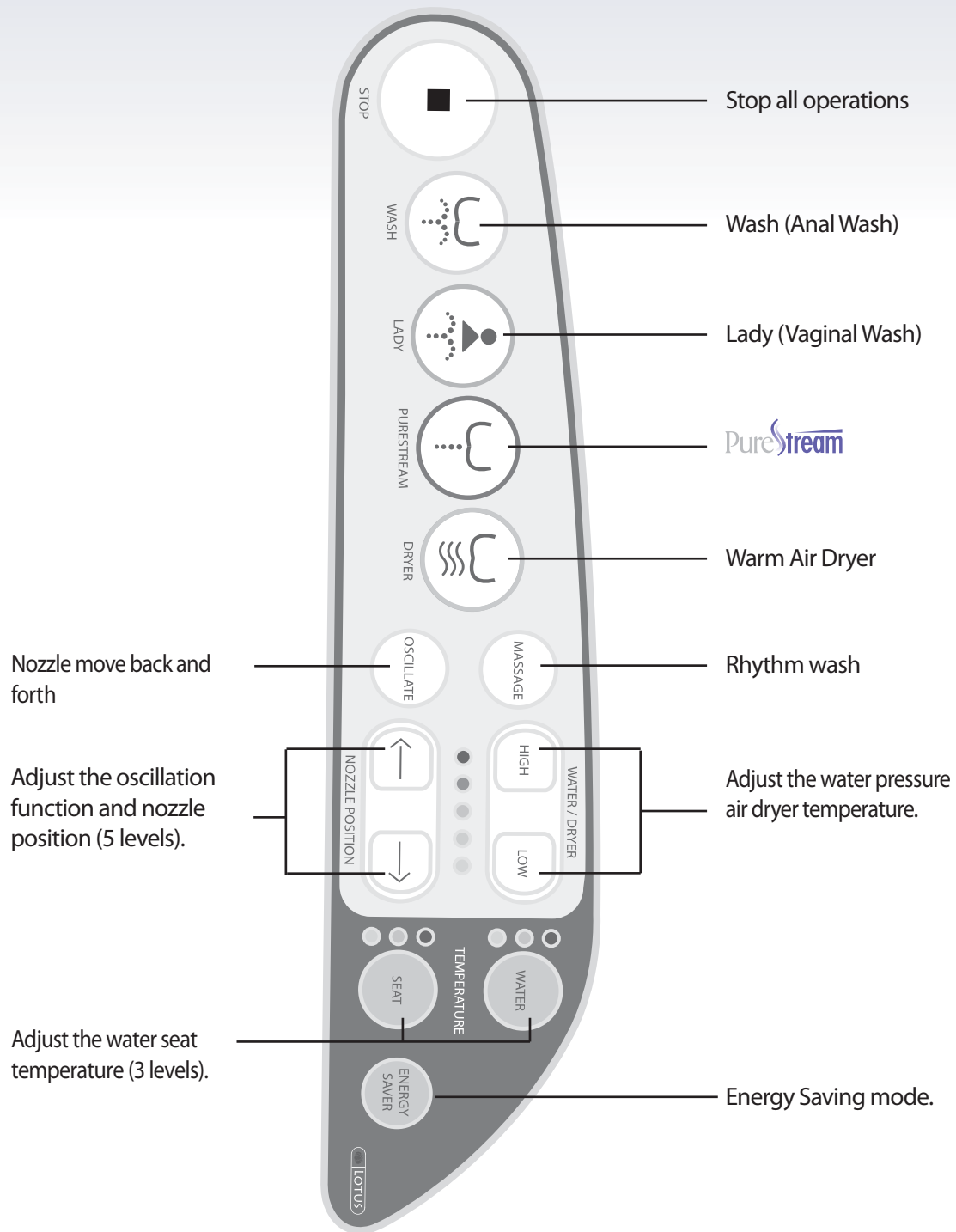



■ After an extended wash, allow about three minutes for water to reheat.

# 5

## OPERATION (DETAILED)

### 1 PREPARATION

- Check for any water leaks.
- Plug the unit into the proper power source and the RED LED power light will start flashing.
- Wait until the RED LED power light stops flashing and becomes solid red.
- The water tank will be filled after pushing a "Wash" ( or ) button.
  - When the water tank is filling the buzzer "Beeps" continuously, after the water tank is full the buzzer will end with "One Solid Beep".

### 2 OPERATION









#### SIT DOWN ON THE SEAT

- When you sit down on the seat, the ORANGE LED lamp on the power panel will light up.
- When the unit is occupied the deodorizer will start working automatically. (909L/R models)



#### STOP

- Press this button to stop all operations.







#### CLEANSING

- **CLEANSING 1. (WASH)** 
  - Press "WASH" () , the nozzle comes out and sprays warm water to posterior. If you press "OSCILLATE", the nozzle moves back and forth automatically. Press again to stop nozzle move.
- **CLEANSING 2. (LADY)** 
  - Press "LADY" () , the nozzle comes out and sprays warm water to vaginal area. If you press "OSCILLATE", the nozzle moves back and forth automatically.
- **CLEANSING 3. (PureStream)** 
  - Press "PURESTREAM" () , the nozzle sprays a highly concentrated water stream that can induce a smooth bowel movement.
  - Press "water pressure-High & Low button" (, ) to adjust the water pressure.



## WARM AIR DRYER

- Press "Dry(  )"; to turn on dryer. Adjust the warm air temperature with "High (  )" and "Low (  )" button. The dryer automatically stop in 3 minutes.  
Warmer Cooler

## WATER PRESSURE / DRYER TEMPERATURE ADJUSTMENT

- After sitting down on the seat, the LED lamp(  ) for water pressure should light at 3 levels(  ). You can adjust the water pressure with "High (  )" and "Low(  )" button. Adjust the "Warm Air Dryer" temperature with "High (  )" and "Low (  )" button. In addition, the unit memorizes the air temperature of prior use.

## WATER/SEAT TEMPERATURE ADJUSTMENT

- The temperature of water and seat can be adjusted to the desired level by 'WATER(  )' and 'SEAT(  )' button.

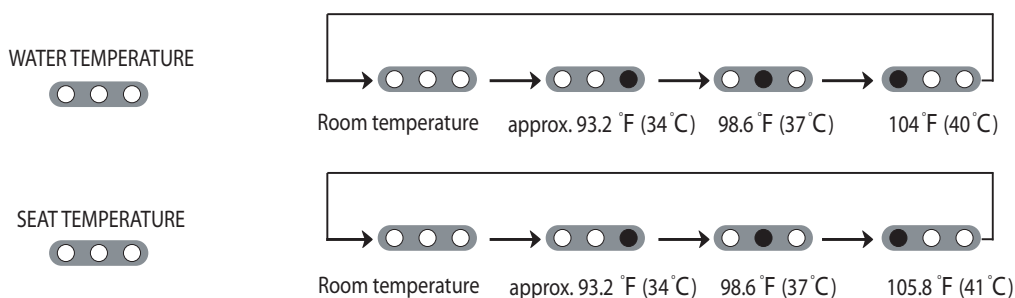

# 5

## OPERATION (DETAILED)

### NOZZLE POSITION ADJUSTMENT

- Nozzle position is adjustable to the desired position by pressing “( ← )” or “( → )” button. After use the nozzle will return to position 3.

### DEODORIZER (ATS-909L, R Only)

- The deodorizer is activated when the unit is occupied. It automatically stops in about 1 minute after user leaves.
- The deodorized air velocity can be adjusted to the desired level by holding “STOP”( ■ ) button down, and pressing “WATER”( WATER ), simultaneously. (Without occupying the seat)

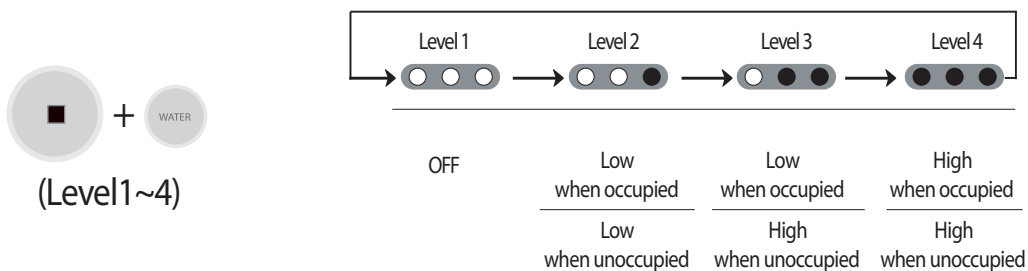

### OSCILLATE ( Nozzle Move )



- When using “WASH” or “LADY”, press the “OSCILLATE” button to get oscillating spray for wider area cleansing. This function is not available during “PURESTREAM”.
- The oscillation can be adjusted to the desired position by pressing “OSCILLATE” and “( ← )” or “( → )”, simultaneously.
- If you push “OSCILLATE” again, the oscillation will stop.

#### \* Auto-Setting of Oscillation

: Without occupying the seat, press “OSCILLATE” button for 3 seconds to set up “Automatic Oscillation”. The oscillation function will operate automatically when “WASH” or “LADY” is pressed.

/ If you press “OSCILLATE” button for 3 seconds again, the Auto-Setting of Oscillation will stop.

## ● MASSAGE (Rhythm Wash)

- In using "WASH" or "LADY" mode, pressing "MASSAGE" button will provide pulsating spray. In addition, the water pressure can be adjusted by pushing "(  ) High or (  ) Low" and "MASSAGE", simultaneously.

### \* Auto-Setting of Massage

: Without occupying the seat, press "MASSAGE" button for 3 seconds to set up Auto-Setting of "MASSAGE". After set up the "MASSAGE" function will operate Automatically in CLEANSING mode.

- If you press "MASSAGE" button for 3 seconds again, the Auto-Setting of MASSAGE will stop.

## ● ENERGY SAVER (Energy Save Mode)

- The ENERGY SAVER is not on when the LED light is off.
- Press button once to choose "ENERGY SAVE 1"
- Press button again to choose "ENERGY SAVE 2".
- Press button the third time to turn "ENERGY SAVER" off.



\* ENERGY SAVER 1 : the water temperature will be kept at 90°F

\* ENERGY SAVER 2 (SMART MODE) : the unit will lower the water temperature to 90°F when it is not being used, and raise the water temperature back to normal level during the time of use. It takes about four days for the unit to "learn," and "remember," the usage pattern of the user(s).

## ● NOZZLE CLEANING (Automatic)

- This product has an automatic nozzle self-cleaning function that cleans the nozzle before and after each use.

## ● NOZZLE CLEANING (Manual)

- Nozzle can be cleaned manually at any time without seat being occupied. Press "WASH (  )" button for 3 seconds and nozzle will come out without Spraying water. After cleaning the nozzle, Press "STOP (  )" button to retract nozzle.

## ● BUZZER SOUND

- Occupying the seat Press "OSCILLATE" button for 3 seconds, you can set the buzzer sound to on or off.

# 3

## IDENTIFICATION (ATS-1000)

### 1 MAIN UNIT

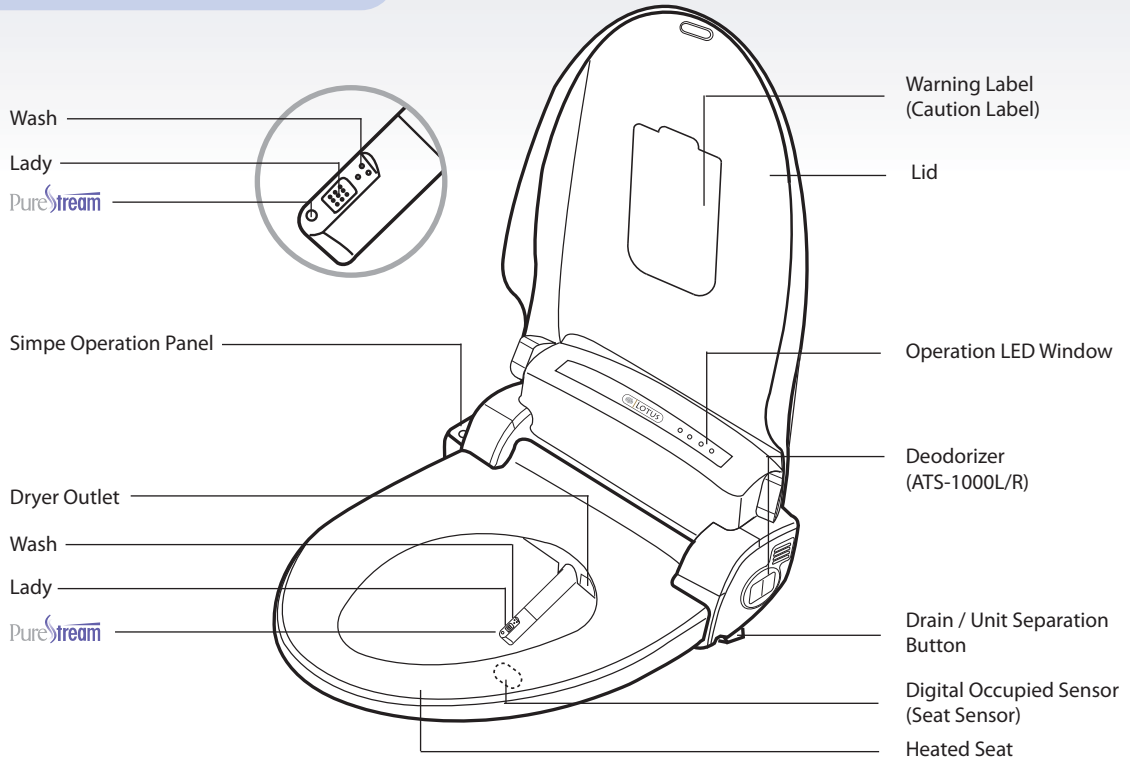

### 2 IN THE BOX

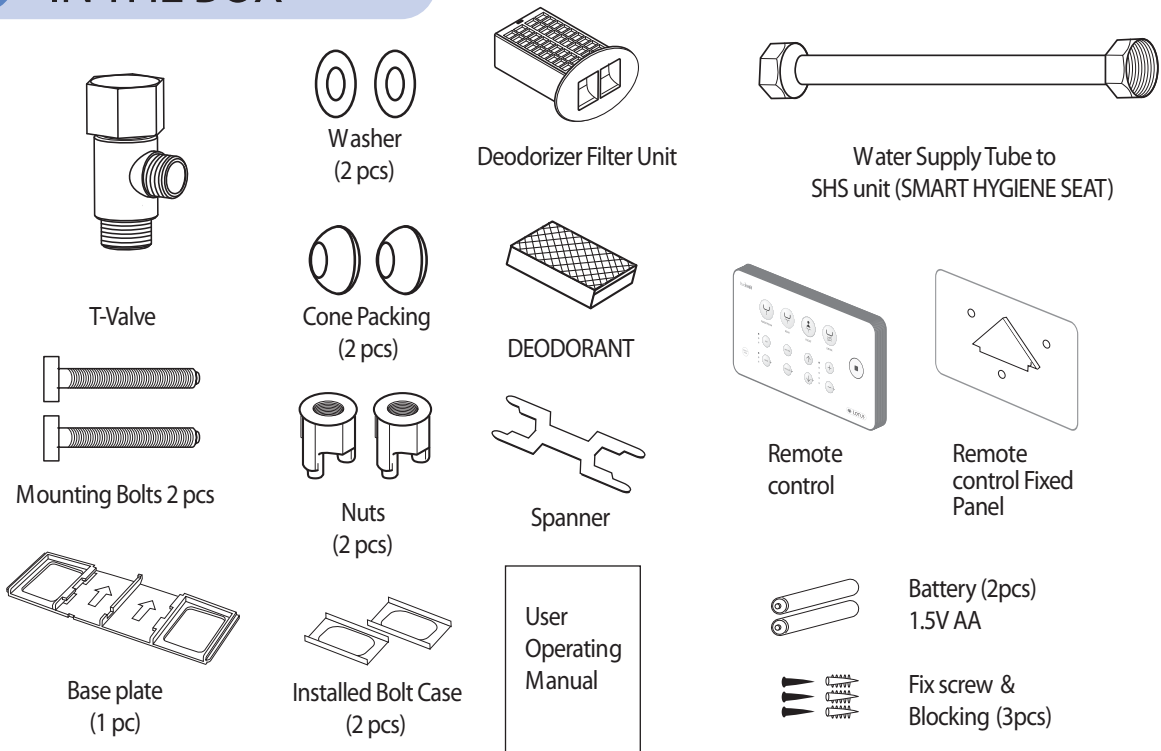

# 4 OPERATION (BASIC)

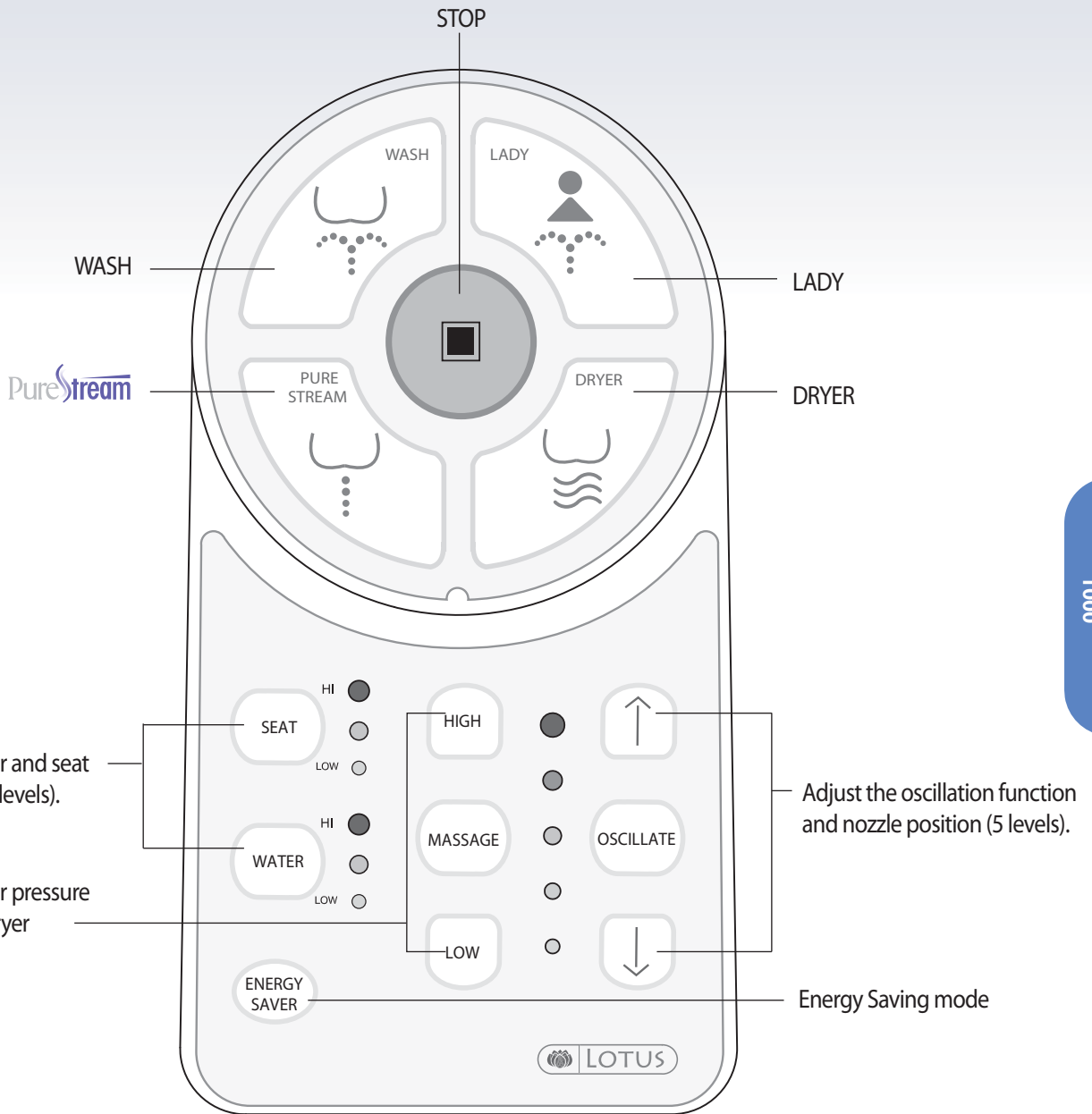

OPERATION 1000

Simple Operation Panel

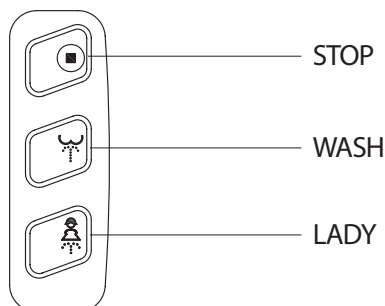

- When you sit on the unit, please sit down on the central position in order to activate the sensor.
- After an extended wash, allow about three minutes for water to reheat.

# 5

## OPERATION (DETAILED)

### 1 PREPARATION

- Check for any water leaks.
- Plug the unit into the proper power source and the RED LED power light will start flashing.
- Wait until the RED LED power light stops flashing and becomes solid red.
- The water tank will be filled after pushing a "Wash" () button on the simple operation panel.
  - *When the water tank is filling the buzzer "Beeps" continuously, after the water tank is full the buzzer will end with "One Solid Beep".*

### 2 OPERATION

#### SIT DOWN ON THE SEAT

- When you sit down on the seat, the ORANGE LED lamp on the power panel will light up.
- When the unit is occupied the deodorizer will start working automatically.

#### STOP

- Press this button to stop all operations.

#### CLEANSING



##### CLEANSING 1. (WASH)

- Press "WASH" () , the nozzle comes out and sprays warm water to posterior. If you press "OSCILLATE (Move)", the nozzle moves back and forth automatically. Press again to stop nozzle move.

##### CLEANSING 2. (LADY)

- Press "LADY" () , the nozzle comes out and sprays warm water to feminine area. If you press "OSCILLATE (Move)", the nozzle moves back and forth automatically. Nozzle stops moving when the switch is pressed again and it automatically stops after two minutes.

##### CLEANSING 3. (PureStream)

- Press "PURESTREAM" () , the nozzle sprays a highly concentrated water stream that can induce a smooth bowel movement.
- Press "water pressure-High & Low button" () to adjust the water pressure.



## ☺ WARM AIR DRYER

- Press "Dry( ☺ )"; to turn on dryer. Adjust the warm air temperature with "High( ⊕ )" and "Low( ⊖ )" button. The dryer automatically stop in 3 minutes.  
Warmer
Cooler

## ● WATER PRESSURE / DRYER TEMPERATURE ADJUSTMENT

- After sitting down on the seat, the LED lamp( ○○○○○ ) for water pressure should light at 3 levels( ○○●●● ). You can adjust the water pressure with "High( ⊕ )" and "Low( ⊖ )" button. Adjust the "Warm Air Dryer" temperature with "High( ⊕ )" and "Low( ⊖ )" button. In addition, the unit memorizes the air temperature of prior use.

## ● WATER / SEAT TEMPERATURE ADJUSTMENT

- The temperature of water and seat can be adjusted to the desired level by 'WATER( WATER )' and 'SEAT( SEAT )' button.

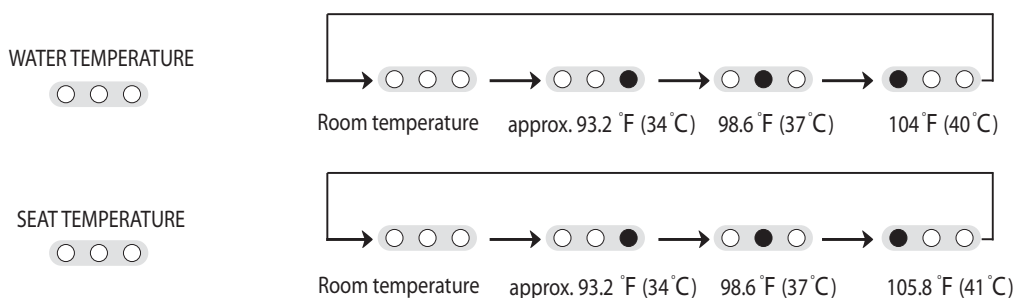

# 5

## OPERATION (DETAILED)

### NOZZLE POSITION ADJUSTMENT

- Nozzle position is adjustable to the desired position by pressing “(↑)” or “(↓)” button. After use the nozzle will return to position 3.

### DEODORIZER (ATS-1000L, R Only)



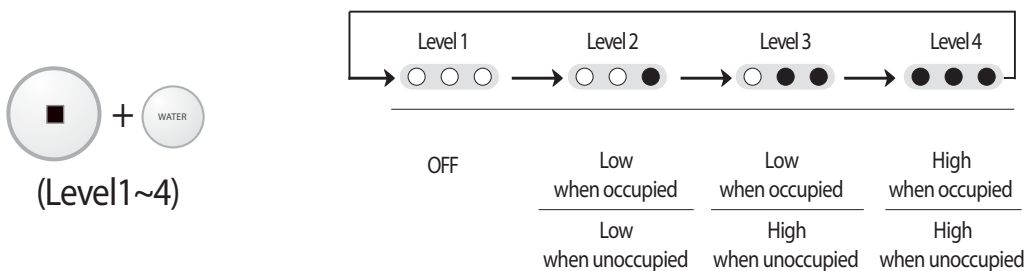

- The deodorizer is activated when the unit is occupied. It automatically stops in about 1 minute after user leaves.
- The deodorized air velocity can be adjusted to the desired level by holding “STOP”(■) button down, and pressing “WATER”(WATER), simultaneously. (Without occupying the seat)



### OSCILLATE ( Nozzle Move )

- When using “WASH”(WASH) ” or “LADY”(LADY)”, press the “OSCILLATE” button to get oscillating spray for wider area cleansing. This function is not available during “PURESTREAM”.
- The oscillation can be adjusted to the desired position by pressing “OSCILLATE” and “front (↑)” or “back (↓)”, simultaneously.
- If you push “OSCILLATE” again, the oscillation will stop.
  - \* Auto-Setting of Oscillation
    - : Without occupying the seat, press “OSCILLATE” button for 3 seconds to set up “Automatic Oscillation”. The oscillation function will operate automatically when “WASH” or “LADY” is pressed.
    - / If you press “OSCILLATE” button for 3 seconds again, the Auto-Setting of Oscillation will stop.

## ● MASSAGE (Rhythm Wash)

- In using "WASH (  )" or "LADY (  )" mode, pressing "MASSAGE" button will provide pulsating spray. In addition, the water pressure can be adjusted by pushing "(  ) High or (  ) Low" and "MASSAGE", simultaneously.

### \* Auto-Setting of Massage

: Without occupying the seat, press "MASSAGE" button for 3 seconds to set up Auto-Setting of "MASSAGE". After set up the "MASSAGE" function will operate Automatically in CLEANSING mode.

/ If you press "MASSAGE" button for 3 seconds again, the Auto-Setting of MASSAGE will stop.

## ● ENERGY SAVER (Energy Save Mode)

- The ENERGY SAVER is not on when the LED light is off.
- Press button once to choose "ENERGY SAVE 1"
- Press button again to choose "ENERGY SAVE 2".
- Press button the third time to turn "ENERGY SAVER" off.



\* ENERGY SAVER 1 : the water temperature will be kept at 90°F

\* ENERGY SAVER 2 (SMART MODE) : the unit will lower the water temperature to 90°F when it is not being used, and raise the water temperature back to normal level during the time of use. It takes about four days for the unit to "learn," and "remember," the usage pattern of the user(s).

## ● NOZZLE CLEANING (Automatic)

- This product has an automatic nozzle self-cleaning function that cleans the nozzle before and after each use.

## ● NOZZLE CLEANING (Manual)

- Nozzle can be cleaned manually at any time without seat being occupied. Press "WASH (  )" button for 3 seconds and nozzle will come out without Spraying water. After cleaning the nozzle, Press "STOP (  )" button to retract nozzle.

**NOTE: only works on the simple operation control panel.**

# 6 INSTALLATION



## CAUTION BEFORE INSTALLATION

- Please, do not plug in before installation.
- If you need an electric power outlet or extension, please consult a qualified electrician.

## STEPS

- 1** Shut off water supply then flush toilet. Remove the water supply hose to toilet tank (Part A).

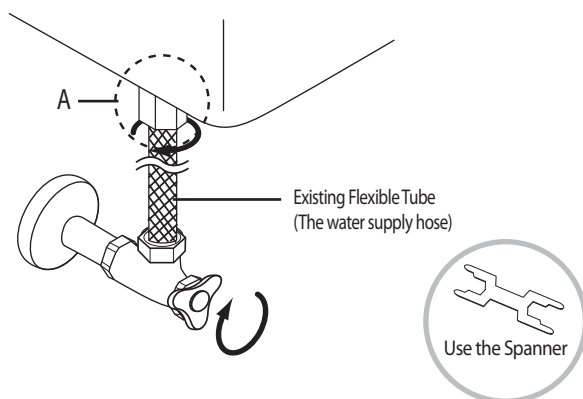

- 2** Connect T-Valve. Install T-Valve as shown.

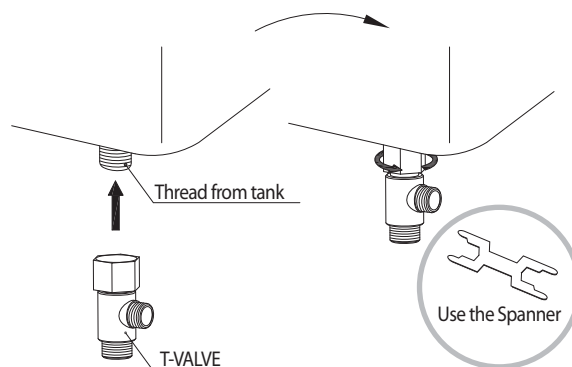

- 3** Connect Water supply hose to the T-Valve.

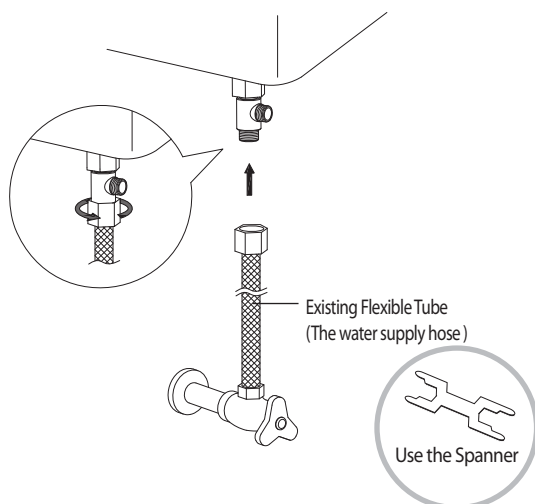

- 4** Removing existing seat and lid.



5

Put the BOLT into METAL BOLT CASE and align with the top of the BASE PLATE. Insert BOLT with METAL BOLT CASE onto the BASE PLATE.

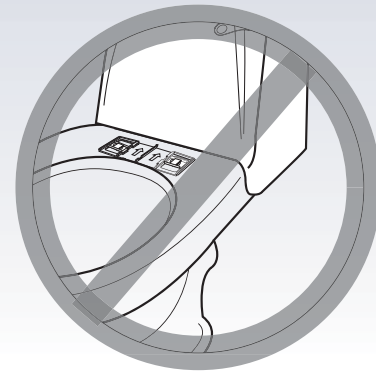
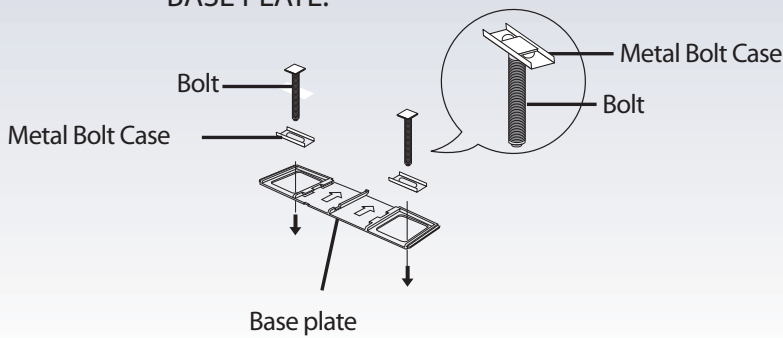

**DO NOT MOUNT Base Plate to toilet bowl. Follow step 6.**

6

Flip the base plate with bolt/metal bolt case upside-down and slide into the grooves at the bottom of the unit, slide until it snaps in place.

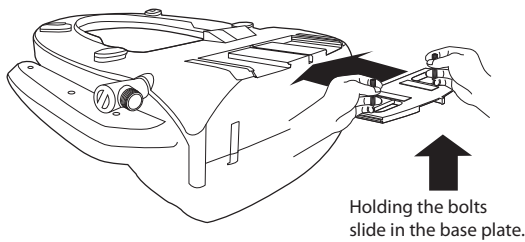

7

Install the main unit and insert the mounting bolts to the toilet mounting holes.

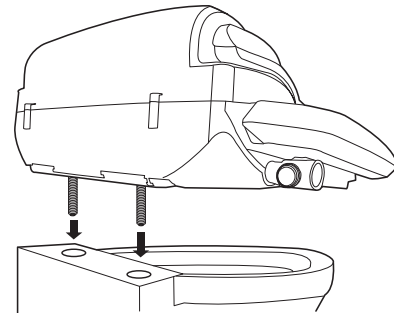

8

Fit the cone packing and plastic washers onto the bolts from below the toilet, and then tighten the nuts securely.

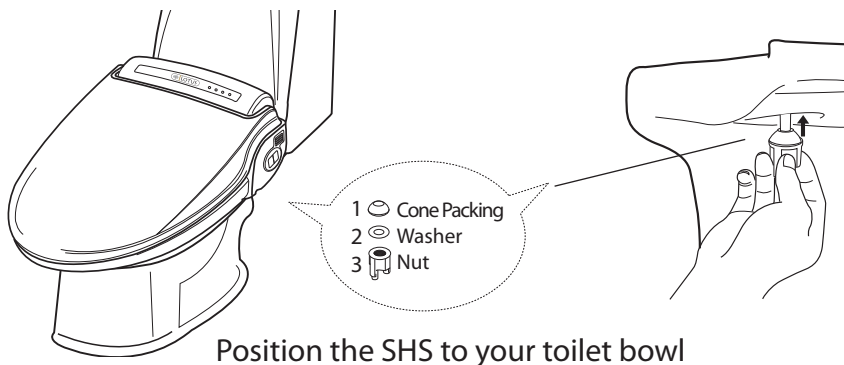

9

Connect the flexible tube from side of T-Valve to SHS unit, Open the Angle Stop valve to fill water.

\* Check for any water leaks.

*(TEFLON tape is strongly recommended to prevent leakage at all T-Valve and flexible tube connections.)*

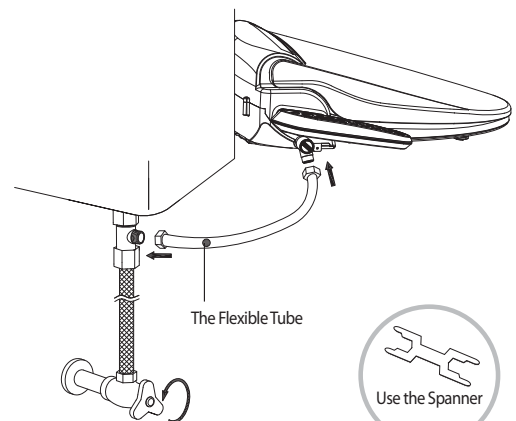

# 6 INSTALLATION

10 Insert the deodorant catalyst into the unit. (ATS-909L/R, ATS-1000L/R)

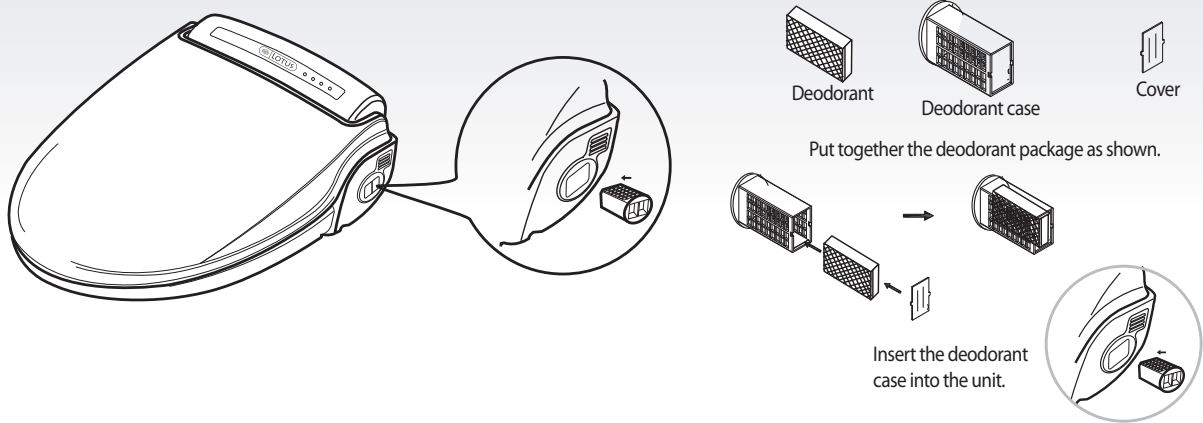

# 6 INSTALLATION - FIRST TIME SETUP

1

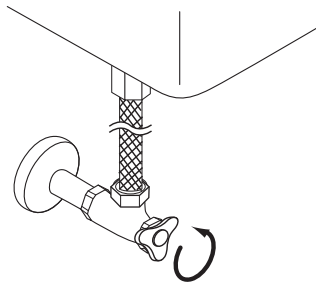

Turn on water valve.

2

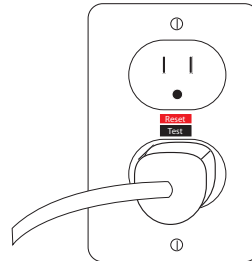

Plug into power outlet.

3

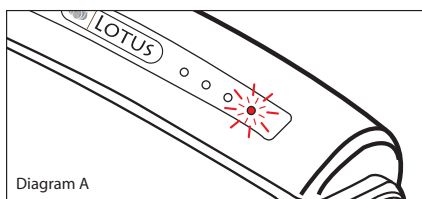

Diagram A

Power Red LED blinking

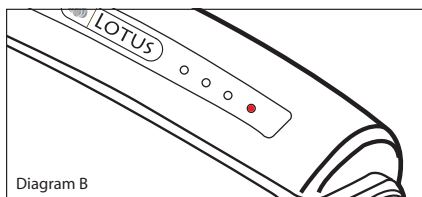
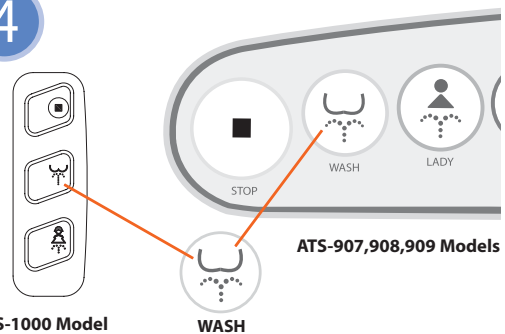

Diagram B

Power Red LED solid

Wait until power LED turns solid red shown in diagram B before proceeding.

4



ATS-1000 Model  
(Simple side control)

ATS-907,908,909 Models

Without sitting on seat, push rear soft to fill water tank completely. Water tank will start filling and making a beeping sound. Make sure you hear water filling. Wait until it stops beeping before proceeding.

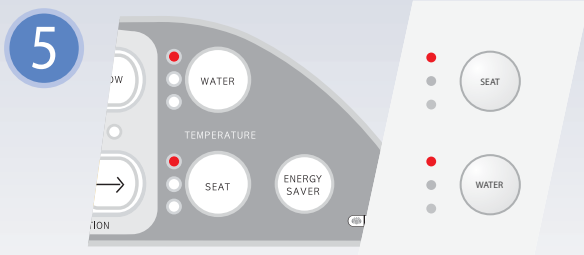

5 Once the water tank is full, push the water and seat temperature button to red LED.



6 Please wait five minutes and once you feel the seat/water is hot then the unit is ready to be adjusted to your desired temperature

## 7 SEPARATION OF UNIT FROM THE TOILET BOWL

In case you need to remove the SHS unit from the toilet bowl, follow these steps.

- 1 Disconnect the power plug
- 2 Shut off the Water Supply Angle Valve. Turn off water and seat temperature.
- 3 Push and hold the button on the right side of the unit to completely drain the water from water tank.
- 4 Separate the unit from toilet as Shown below.

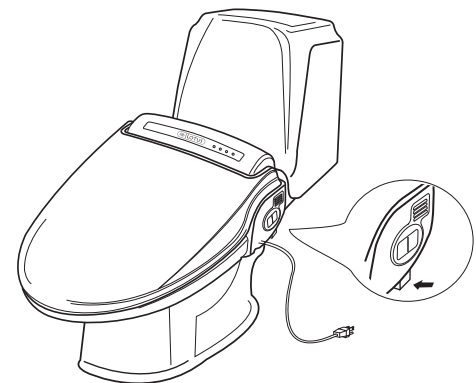

▪ If you pull the unit without pushing the drain button, the unit will not be separated from base plate.

⚠ Do not turn unit upside down.

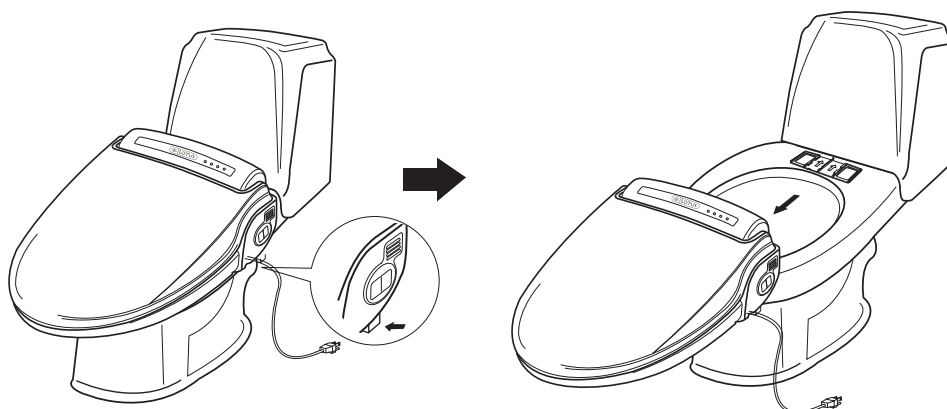

- 5 Disconnect the hose from the T-Valve unit (Refer to page # 20).

INSTALLATION

# 8

## MAINTENANCE

### CLEANING THE NOZZLE

In case the nozzle is soiled and needs to be cleaned, press "WASH" (  ) button for 3 seconds without occupying the seat, the nozzle will extend out without spraying water.

After cleaning, Press "STOP" (  ) button to retract nozzle.

\* For ATS-1000 model use , .

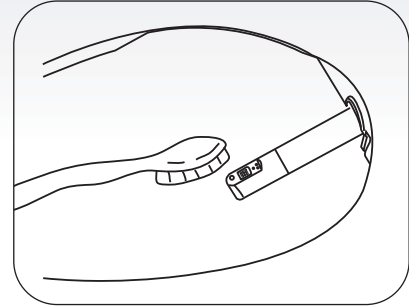

### CLEANING THE BODY OF UNIT

- When you clean the body, do not use "thinner", "benzene" or "NaClO". It causes defects to the surface of unit.
- Please use a damp cloth when you clean the unit.
- Do not spray water directly on the unit.
- When you clean the unit, please disconnect the power plug.

### CLEANING THE STRAINER

The product will not operate properly if the strainer is clogged. Please clean the strainer regularly.

- 1) Close the shut off valve.
- 2) Flush the toilet to empty the water reservoir.
- 3) Unscrew the water strainer nut.
- 4) Clean the strainer with a small brush or water.
- 5) Re-screw the water strainer nut.
- 6) Open the shut off valve.

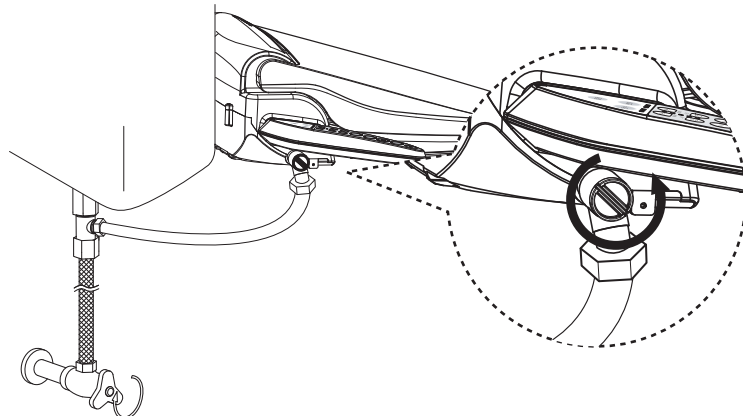
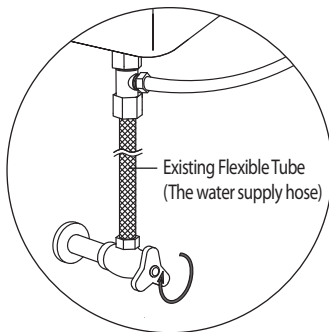



# 9 WATER DRAINING

## ● DRAIN THE WARM WATER TANK IN THE UNIT

If you are going to leave the unit unused for a long time, please drain water from the unit's warm water tank.

1) Disconnect the power plug.

2) Close the shut off valve.

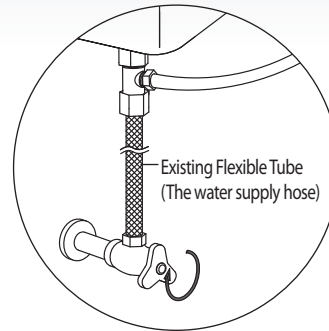

3) Press and hold the drain button until the water is completely drained from the unit's water tank.

4) To re-supply water after draining, open the shut off valve.

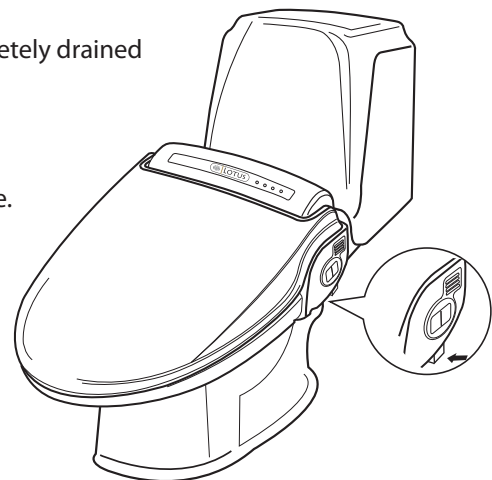

Before draining, unplug the power cord and wait 30 minutes until the unit has cooled down.

- 1 Check that the power cord is plugged in securely.
- 2 Set water temperature at "Middle or High" to prevent water from freezing.
- 3 If you are going to leave the unit unused for a long time, please disconnect the power plug and drain the water.

Trouble	Cause	Remedy
The water does not spray	<ol style="list-style-type: none"> <li>1. The water tank is not filled.</li> <li>2. The shutoff valve is closed.</li> <li>3. Freezing inside the main unit or the water supply pipe.</li> </ol>	<ol style="list-style-type: none"> <li>1. Wait about one minute.</li> <li>2. Press the desired washing button once again.</li> <li>3. Turn on the shutoff valve to open.</li> <li>4. Heat the room (for about two hours). Operating the unit while parts are frozen will cause a malfunction.</li> </ol>
The unit is not operating	<ol style="list-style-type: none"> <li>1. Disconnected the power cord.</li> <li>2. The seat is not occupied.</li> <li>3. The battery of remote controller is exhausted.(Only ATS-1000L/R model)</li> </ol>	<ol style="list-style-type: none"> <li>1. Connect the power cord.</li> <li>2. Check the power supply system in your house.</li> <li>3. Occupy the seat (It does not operate unless occupied).</li> <li>4. Replace the battery. (Only ATS-1000L/R model)</li> </ol>
Water is leaking	<ol style="list-style-type: none"> <li>1. Check the water supply system</li> </ol>	<ol style="list-style-type: none"> <li>1. If water is leaking from the main unit, call the service center or the place you purchased.</li> </ol>
Water pressure is weak	<ol style="list-style-type: none"> <li>1.The water pressure level is set to "LOW". (⊖)</li> <li>2. The strainer is clogged.</li> </ol>	<ol style="list-style-type: none"> <li>1.Set the water pressure to "HIGH". (⊕)</li> <li>2. Clean the strainer.</li> </ol>
Water is not warm	<ol style="list-style-type: none"> <li>1. The water temperature is set to "LOW". (⊖)</li> <li>2. Continuous operation has depleted the supply of warm water.</li> </ol>	<ol style="list-style-type: none"> <li>1.Set the water temperature to "HIGH" (⊕)</li> <li>2. Wait about three minutes.</li> </ol>
The seat and dryer is not warm	<ol style="list-style-type: none"> <li>1.The seat &amp; dryer temperature is set to "LOW" (⊖)</li> </ol>	<ol style="list-style-type: none"> <li>1. Set the seat &amp; dryer temperature to "HIGH". (⊕)</li> </ol>

# 11

# SPECIFICATIONS

Specifications		ATS-907	ATS-908	ATS-909	ATS-1000
Power Rating		AC 120V 60Hz 660W			
Water inlet type	Type	Direct Inlet flow type			
	Water inlet pressure	0.4 ~ 7.5 kgf/cm <sup>2</sup> (5.69 psi ~ 106.7psi)			
Power cord		1.2m (4 feet)			
Wash Device	WASH	Max. 1.2ℓ/min ( Max. 0.32 GPM)			
	LADY	Max. 1.2ℓ/min ( Max. 0.32 GPM)			
	Water Pressure Adjustable	5 Levels			
	Warm Water Temperature	Room Temp - 40°C (Room Temp. 104 °F )			
	Heater	600 W			
	Safety Devices	Thermal fuse, Thermal switch, Float switch			
Heated Seat	Temperature	Room Temp ~ 41°C (Room Temp. ~ 105.8°F )			
	Heater	55W			
	Safety Device	Thermal fuse			
Warm Air Dryer Device	Adjustable Dry Temperature (Room Temp~45°C)				
	Heater (250W)	—	○	○	○
	Safety Device (Thermal fuse, bimetal)				
Purestream		○	○	○	○
Deodorizer		—	—	○	○
Remote control		—	—	—	○
Inlet water temperature		3°C~ 35°C(37.4 °F~ 95 °F )			
Ambient Temperature		3°C~ 40°C(37.4 °F~ 104°F )			
Dimension	<b>ATS-907L, 908L, 909L</b>		<b>ATS-1000</b>		
	Round L : 493mm(19.4 inch) W : 473 mm(18.6 inch) H : 185mm(7.28 inch)	Elongated L : 525mm(20.6 inch) W : 473 mm(18.6 inch) H : 185mm(7.28 inch)	Round L : 493mm(19.4 inch) W : 475 mm(18.7 inch) H : 185mm(7.28 inch)	Elongated L : 525mm(20.6 inch) W : 475 mm(18.7 inch) H : 185mm(7.28 inch)	
Weight (kg, lbs)		5.1kg (11.2 lbs)	5.3kg (11.7 lbs)	5.4kg (11.9 lbs)	5.2kg (11.5 lbs)

## 12 INFORMATION TO THE USER

This equipment has been tested and found to comply with the limits for a Class B digital device, pursuant to part 15 of the FCC Rules. These limits are designed to provide reasonable protection against harmful interference in a residential installation. This equipment generates, uses and can radiate radio frequency energy and, if not installed and used in accordance with the instructions, may cause harmful interference to radio communications. However, there is no guarantee that interference will not occur in a particular installation. If this equipment does cause harmful interference to radio or television reception, which can be determined by turning the equipment off and on, the user is encouraged to try to correct the interference by one more of the following measures:

- Reorient or relocate the receiving antenna.
- Increase the separation between the equipment and receiver.
- Connect the equipment into an outlet on a circuit different from that to which the receiver is connected.
- Consult the dealer or an experienced radio/TV technician for help.

### WARNING

Changes or modifications not expressly approved by the manufacturer could void the user's authority to operate the equipment.

*"Note : The manufacturer is not responsible for any Radio or TV interference caused by unauthorized modifications to this equipment. Such modifications could void the user's authority to operate the equipment."*

## 13 WARRANTY

### Lotus Hygiene Systems Inc. Limited Warranty

This limited warranty gives you specific legal rights, and you may also have other rights that may vary from state to state or according to other conditions.

General Limited Warranty Covered The Manufacturer, *Lotus Hygiene Systems Inc.* will warrant to the original retail buyer only, which fails in normal use and within the applicable periods specified below, following the terms of this warranty. *Lotus Hygiene Systems Inc.* replacement will be warranted to the original purchaser of the products.

The Parts Warranty If the parts fail within Twelve (12) months after original installation following the installation manual and normal operation, *Lotus Hygiene Systems Inc.* will furnish a replacement part(s).

## ● This Warranty does not cover the following

1. Defects and/or malfunctions from failure to properly install, operate and/or maintain the unit in accordance with the installation manual.
2. Damage from abuse, fire, flood, freeze, and any other acts of Nature.
3. Damage resulting from unauthorized alterations, attachments and/or repairs.
4. If the product was not installed properly to residential water closets.
5. Damage from installing the unit in an environment with animals, mice or insects.
6. Damage caused by excess moisture or from water clogging the water closet.
7. Damage from not being installed in accordance with all applicable local codes, ordinances and good trade practices.
8. Color fading due to use in wrong environments.
9. Damage from consumable chemicals.
10. The warranty will not be covered without providing the date of purchase with original receipts.
11. Damage from misuse due to not following the installation manual.

### WARRANTY REGISTRATION

To ensure your warranty protection you must complete and return this card to Lotus Hygiene Systems Inc. within 15 days after date of purchase.

Model \_\_\_\_\_ \*Serial Number # \_\_\_\_\_

Purchaser

\_\_\_\_\_

Company \_\_\_\_\_

Address \_\_\_\_\_

City \_\_\_\_\_ Country \_\_\_\_\_

Phone \_\_\_\_\_ Fax \_\_\_\_\_ E-mail \_\_\_\_\_

Dealer (Company)

\_\_\_\_\_ Dealer Code \_\_\_\_\_

Address \_\_\_\_\_

\_\_\_\_\_

PLACE  
STAMP  
HERE

Service  
Department  
Inquiries and Support

### Lotus Hygiene Systems Inc.

1621 E. St. Andrew Pl.,  
Santa Ana, CA 92705  
1.877.808.0055  
www.LotusSeats.com

\* The serial number is located in the back of the unit.



1.877.808.0055

[www.LotusSeats.com](http://www.LotusSeats.com)

Inquiries and Support

**Lotus Hygiene Systems Inc.**

1621 E. St. Andrew Pl., Santa Ana, CA 92705

1.877.808.0055

[www.LotusSeats.com](http://www.LotusSeats.com)