

DRAPERY ROD SET INSTALLATION GUIDE

Note:

Finial shown is for illustration purposes only. It may not represent the style of finial purchased. For larger width windows, two persons may be required for easier leveling.

Tools needed:

Tape Measure, Pencil, Drill & Bit Set, Philips head Screwdriver, Level

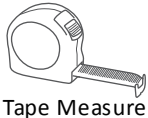

Tape Measure



Pencil



Drill & Bit Set



Philipshead Screwdriver



Level

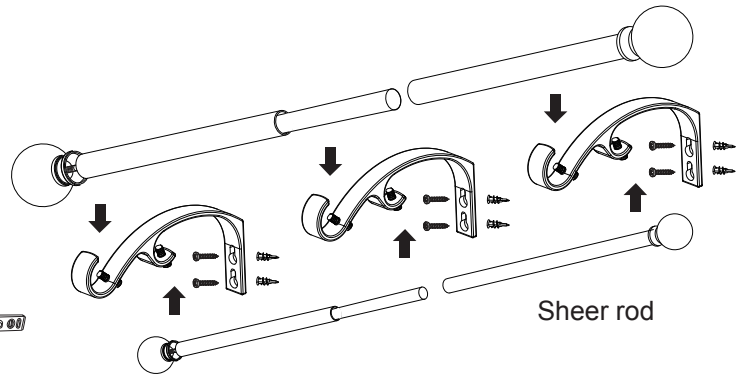

BRACKET INSTALLATION

STEP 1.

Place brackets against wall at desired locations and mark screw holes. Use tape measure and level to make sure marked screw holes are horizontal to each other.

STEP 2A. (FOR MOUNTING TO DRYWALL OR PANELING)

Pre-drill two pilot holes for each bracket (1/4" drill bit) and insert anchors into wall and insert screws into wall anchors.

STEP 2B. (FOR MOUNTING TO WOOD OR STUDS)

If mounting directly into wood or studs, pre-drill two pilot holes for each bracket (1/4" drill bit) and install bracket on the wall with screws provided.

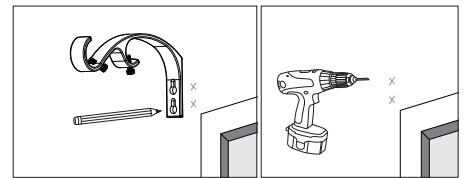

1



2A

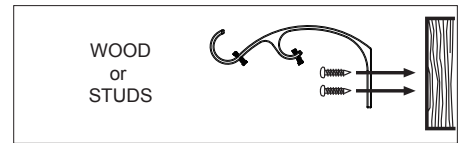

2B

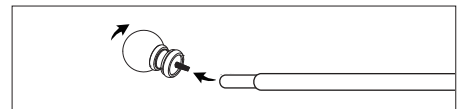

3

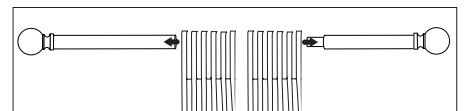

4

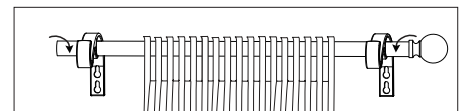

5

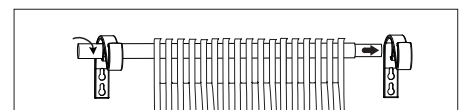

6

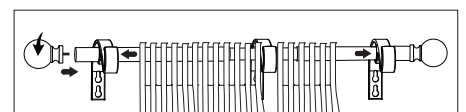

7

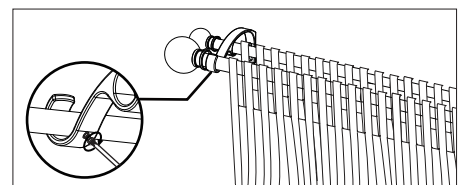

8

ROD INSTALLATION

STEP 3.

Unscrew finial from the smaller diameter telescopic sheer rod.

STEP 4.

Feed half of the sheer panels (not included) onto the sheer telescopic rod and the other half of the sheer panels (not included) onto the other sheer rod.

STEP 5.

Place the telescopic sheer rod on the center and right bracket.

STEP 6.

Place the other sheer rod on the left bracket. Connect the sheer rods to make it a 3 piece telescopic sheer rod.

STEP 7.

Attach finial onto the telescopic sheer rod.

FINAL ADJUSTMENT

STEP 8.

Secure each rod by tightening screws provided.

STEP 9.

Repeat step 3 to 8 for the larger diameter telescopic curtain rod.