

ITEM NO.	P/N	Description	QTY.
1	FRBP	BACKPLATE	2
2	FR-PST	POST	4
3	TU1-12	TUBE	2
4	CARD-1	CAP	4
5	RGGVT	HUB	4

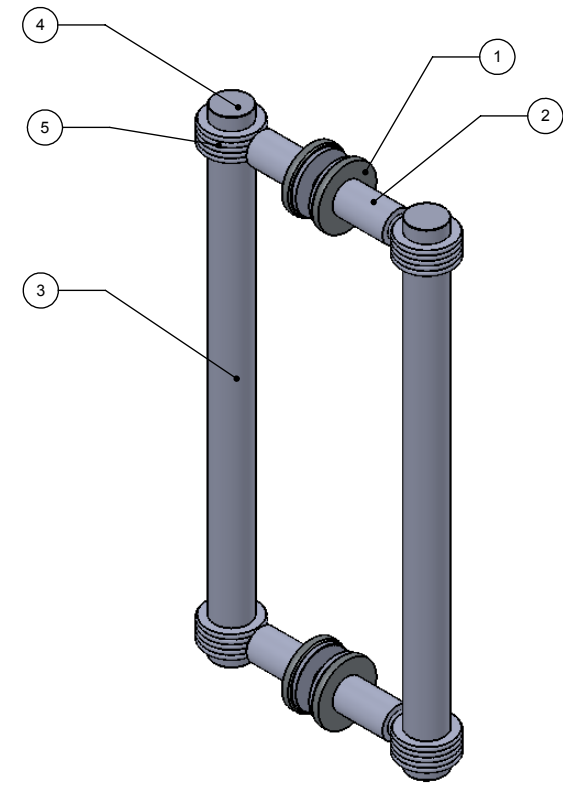
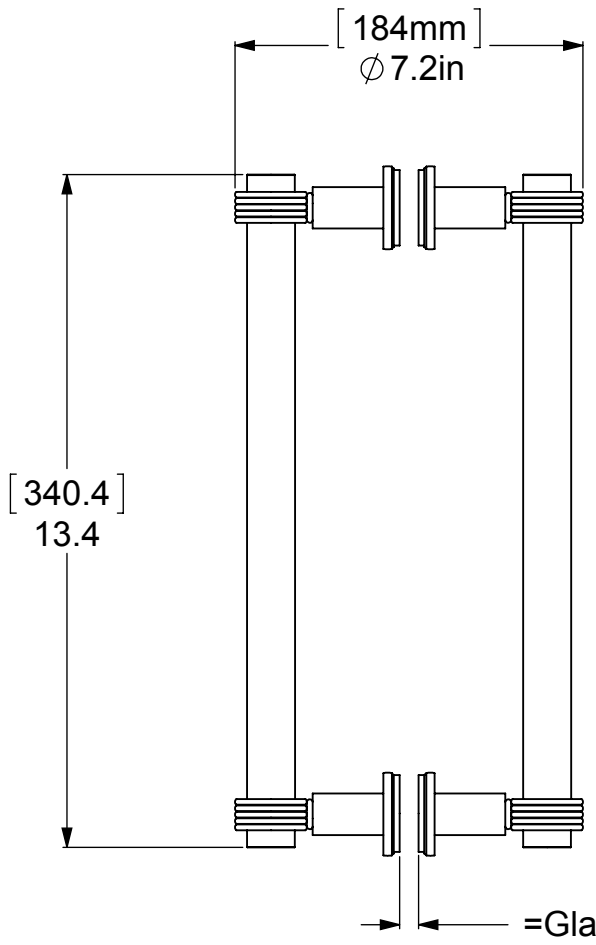

UNLESS OTHERWISE STATED

.X	± .3mm
.XX	± .15mm
.XXX	± .008mm

COPYRIGHT © Allied Brass 2016

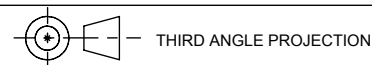

DRAWN	8/14/2016	I.M
CHECKED	8/14/2016	P.D
APPROVED	8/14/2016	R.A

MATERIAL:	BRASS
DESCRIPTION:	SHOWER DOOR PULL

FINISH	TBD
QUANTITY	TBD
DRAWING No.	404G-12BB
REV	0
SCALE	1:4
SHEET: 01	A4