

NEW!

**Screen wall panel
for openings up to
8 ft. (w) x 10 ft. (h)**

**Same Day Shipping
Arrives in 4 days
or less**



Made in the USA

EZ Screen Room



PRSR STD
US Postage Paid
Lake Ozark, MO
Permit No. 11

Is sitting and enjoying your patio not possible due to pest and insects? Are you tired of having to bath your family in bug spray to enjoy or play outside? Are you tired of leaves and debris being blown on to your patio? If you answered with even one yes, then you will love your EZ Screen Room.

Create the perfect outdoor environment with EZ Screen Room. EZ Screen Room is a knockdown pre-engineered screen room system delivered in kit form. The system is designed to be assembled between existing posts and/or railing and covers all sized openings up to 8' wide and 10' tall. Installation is a snap with a few simple tools ; enjoyment is a lifetime.

- ◆ Easy to follow illustrated instructions
- ◆ Residential & Commercial applications
- ◆ Available in White and Dark Bronze
- ◆ Engineered for ground and balcony installations
- ◆ Utilizes flat spline for superior screen retention
- ◆ Powder coat finish
- ◆ 10 year warranty



**Vendor No: 60083341
S/O SKU: 516-036**

**ORDER BY 2PM CST FOR SAME DAY SHIPPING
S/O SKU: 516-036**

CONGRATULATIONS

You are on your way to creating an outdoor living area that will provide years of maintenance free enjoyment. EZ Screen Room's quick and efficient approach to constructing screen walls will have you relaxing in your new outdoor environment in no time.

****PLEASE READ THESE INSTRUCTIONS ENTIRELY BEFORE YOU BEGIN ASSEMBLY****

INTRODUCTION

Please check the contents of EZ Screen Room box against the enclosed packing list. This will allow you to become familiar with the components of your new EZ Screen Room system.

- Inspect all component parts for familiarity
- Layout recommended tools
- Before cutting any component, know its use – “measure twice and cut once”
- Box contents are designed to fit all openings up to 8' wide x 10' tall
- Review all local building codes
- **THE INCLUDED FASTENERS ARE FOR WOOD, CONCRETE, AND BRICK APPLICATIONS**



Note: The screen wall featured to the left is square, The fascia trim is arched. Railing is installed separately.

TOOL CHECKLIST



40 - 80 tooth saw blade



Spline Roller



Variable speed drill



Tape measure



Miter, chop or circ. saw



Framing square



Level



1/4" driver



Pencil



1/8", 1/4" Drill bits



Ear protection



Metal file



Safety Glasses

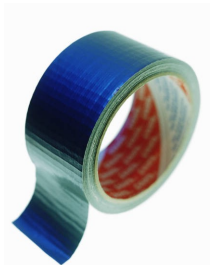

Tape

Understand how to use all power tools, and follow their safety instructions!

Concrete or block installations may require additional tools (hammer drill, masonry bits)

BOX CONTENTS — COMPONENTS: (not all components are viewable in photo)

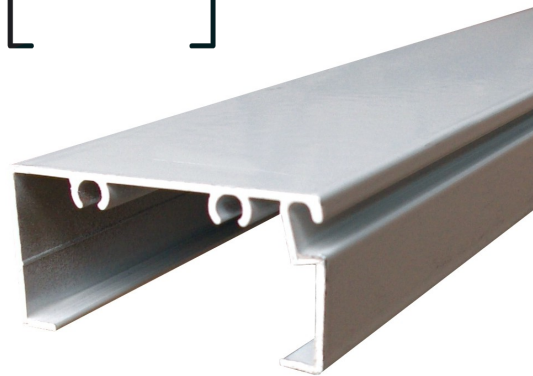
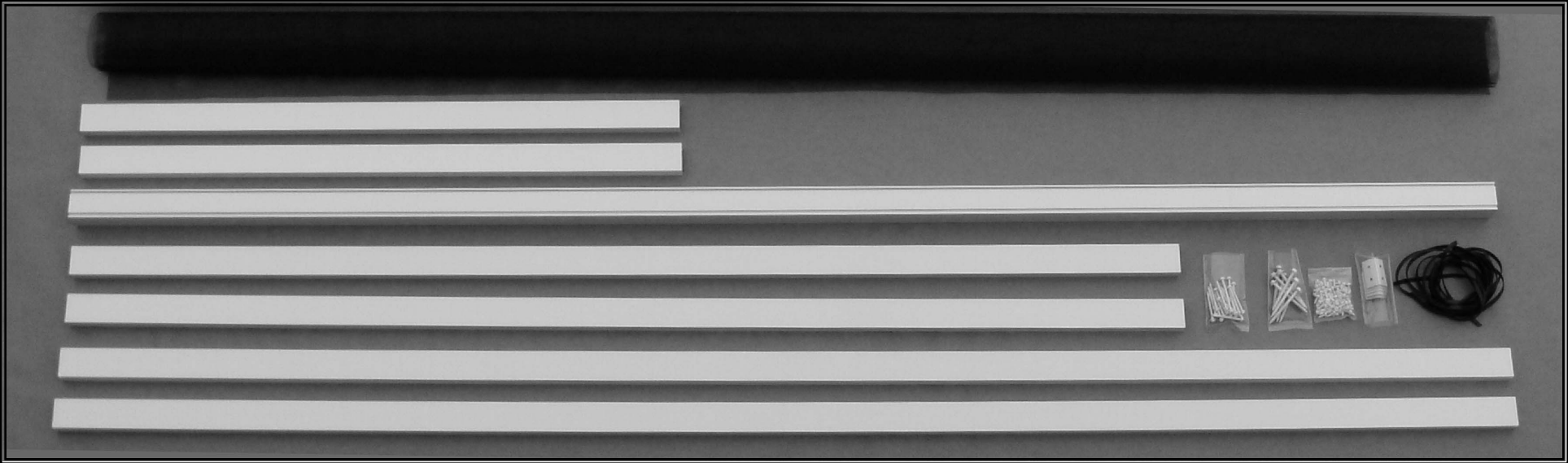

1x2 Open Back—Parts (A,B,D,E,F,G)

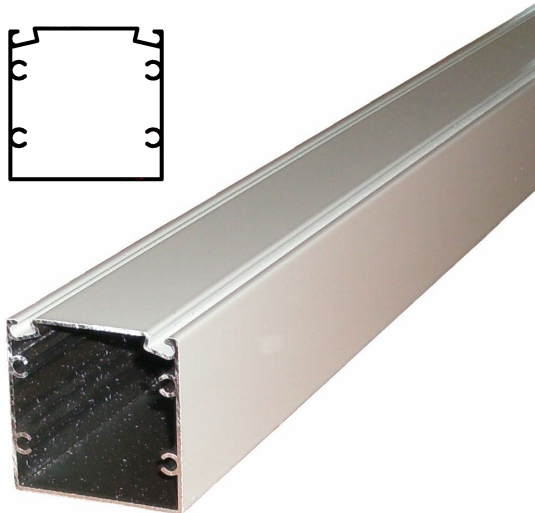
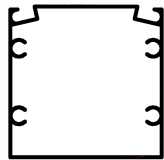

2x2 Post — Part (C)

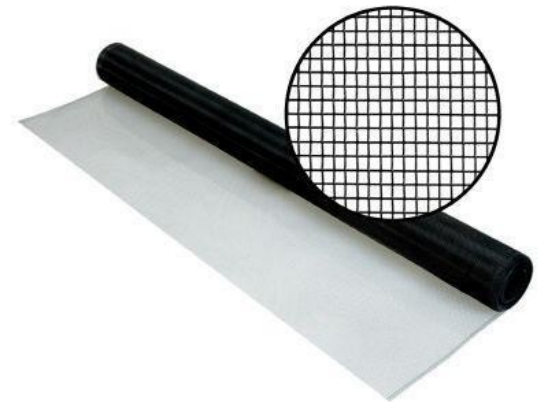

Fiberglass Screen—Part (S1), (S2)



Spline—Part (S3)



Capri Clip— Part (F2)



Fasteners: 2" (F1) , 1/2" ST (F3)

BOX CONTENTS continued — PACKING LIST: (not all components are viewable in photo)



Packing List:

<i>Qty</i>	<i>Length</i>	<i>Description</i>
4	8 ft	1x2 in. aluminum extrusion (Open Back Part# D,E,F,G)
2	4 ft	1x2 in. aluminum extrusion (Open Back Part# A,B)
1	8 ft	2x2 in. post w/ dual screen channels (Part# C)
1	12 ft	8' Fiberglass screen (Part# S1)
1	12 ft	4' Fiberglass screen (Part# S2)
8	2 in	Capri Clips (Part# F2)
10	12 ft	Spline (Part# S3)
50	1/2 in	Self tapping fastener (Part# F3)
30	2 in	Hex head metal/wood fastener (Part# F1)
20	3 in	Hex head metal/wood fastener (Part# F4)
20	4 in	Hex head metal/wood fastener (Part# F5)
20	2 1/4 in	Concrete fastener (Part# F6)

Note: For ACQ treated lumber use stainless 18-8 fasteners (not included)

PLANNING & LAYOUT- SCREEN WALL:

1. DETERMINE WHETHER THE FIBERGLASS SCREEN WILL BE INSTALLED FROM THE INTERIOR OR EXTERIOR OF THE SCREEN ROOM. BEFORE INSTALLING ANY FRAME COMPONENTS ENSURE ALL THE SCREEN CHANNELS FACE THE SAME DIRECTION (SHOWN BELOW).

Note: 2nd level screen rooms or higher are usually installed from the interior for safety and convenience.

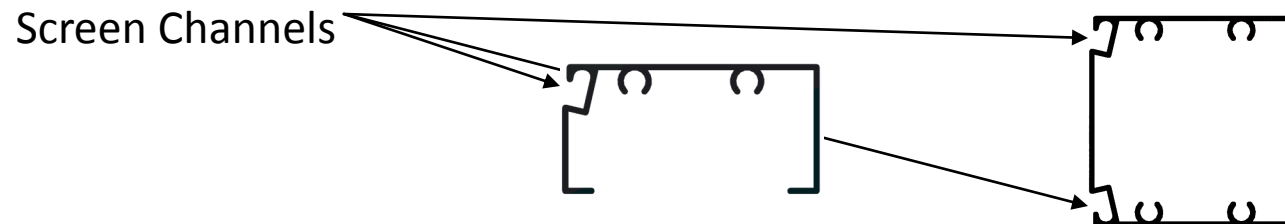

2. DETERMINE THE HEIGHT OF MIDRAIL (C).

THE STANDARD HEIGHT IS USUALLY 36”.

Note: If you have existing railing, position the new Midrail at same height as the top of the existing railing. Be sure that you will have access to the screen channels on the midrail.

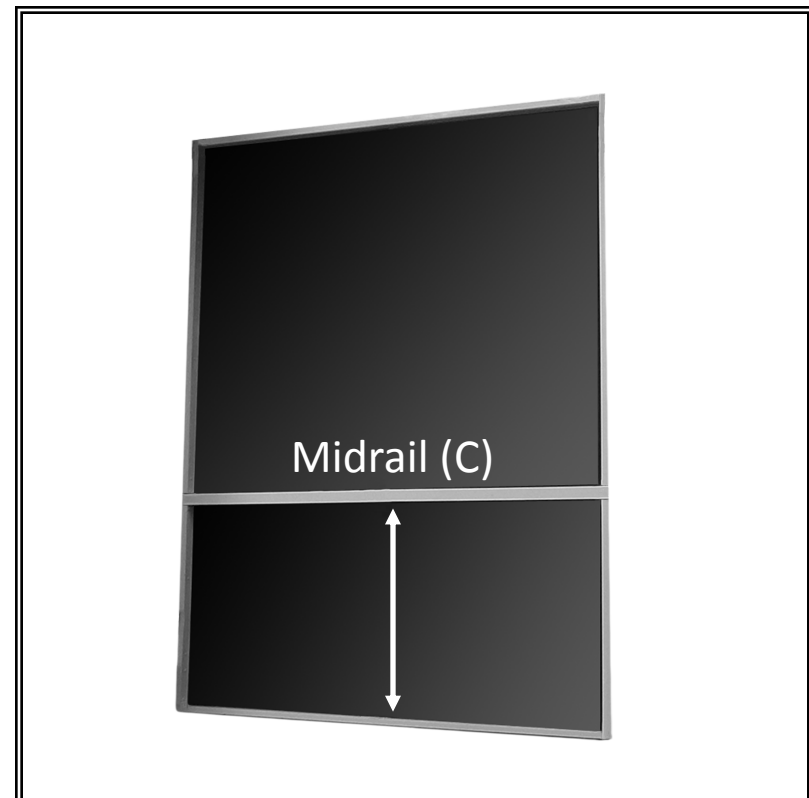

Important: SCREEN DOORS: IF YOU ARE PLANNING A SCREEN DOOR, THE DOOR FRAME MUST BE INSTALLED PRIOR TO CONSTRUCTING THE SCREEN WALL. REFER TO PAGE 18.

MEASURE AND CUT- LOWER SCREEN PANEL:

3. MEASURE AND CUT MIDRAIL (C) TO FIT HORIZONTALLY BETWEEN EXISTING POSTS OR WALLS AT THE DETERMINED HEIGHT, DO NOT INSTALL MIDRAIL UNTIL STEP# 6. MAKE A SMALL PENCIL MARK INDICATING EXISTING HANDRAIL LOCATION.
4. MEASURE AND CUT BOTTOM LEG (A) AND BOTTOM LEG (B) TO FIT BELOW MIDRAIL (C) AND EXTEND TO THE FLOOR. (See illustrations below) DO NOT INSTALL UNTIL NEXT STEP.

IMPORTANT: *Ensure the Midrail (C) will be level when placed on top of Leg (A) and (B). (Illus. A)*

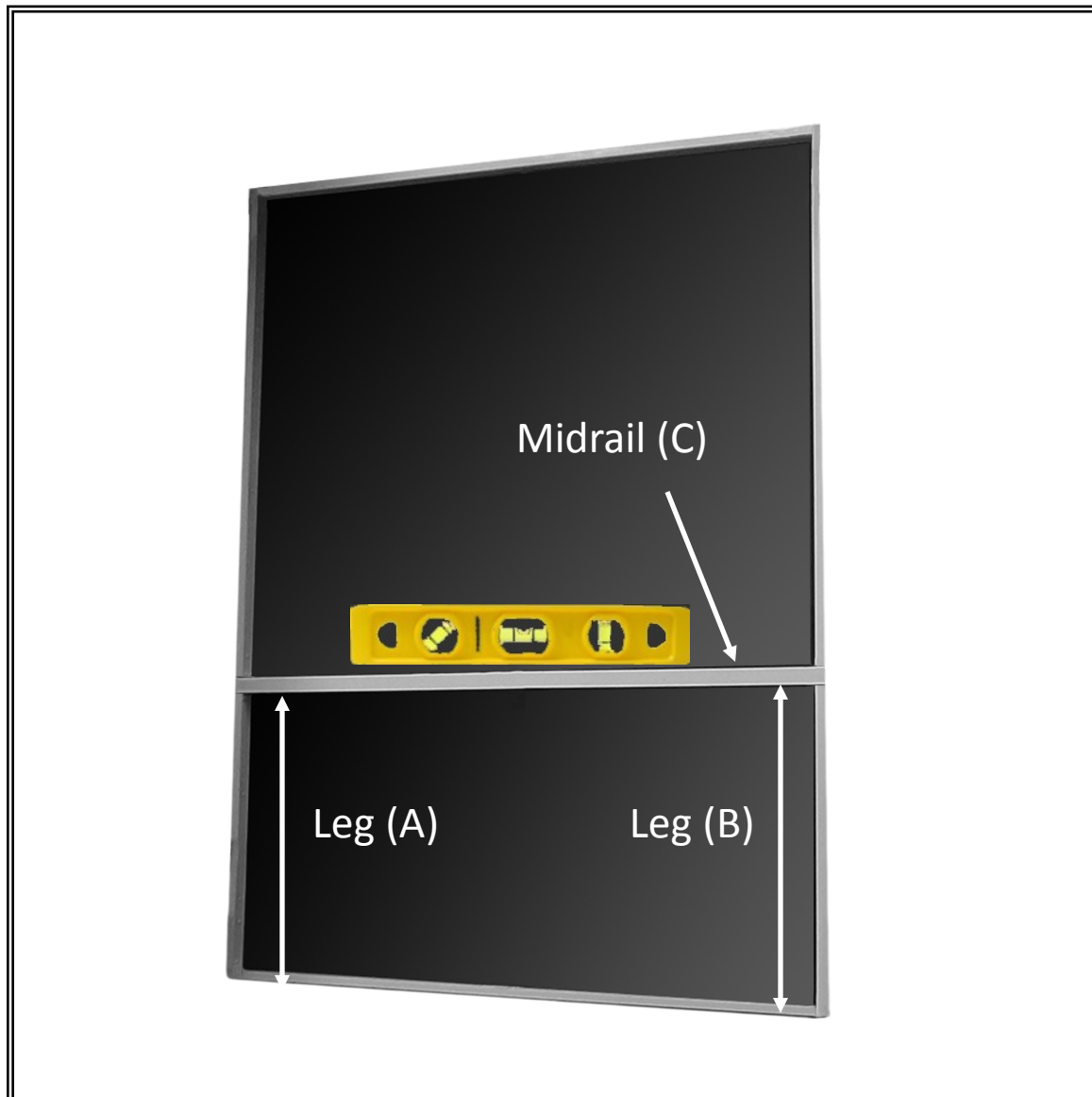

Illus. A

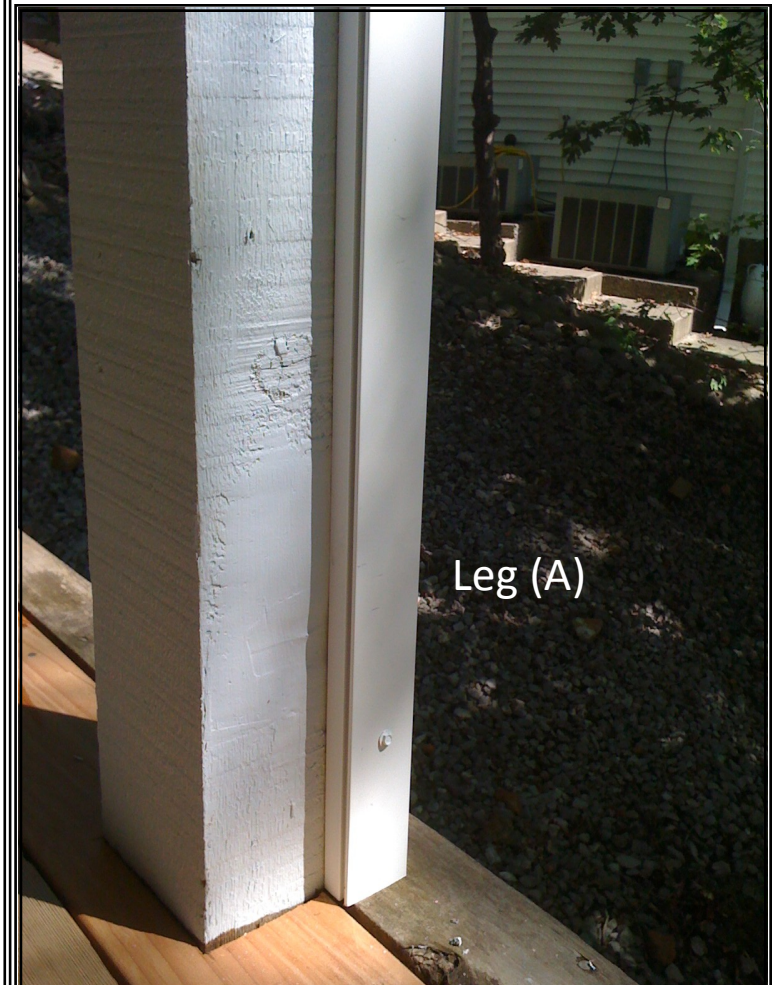

Illus. B

ASSEMBLY- LOWER SCREEN PANEL:

5. INSTALL (A) AND (B) WITH 2" FASTENERS (F1) SPACED EVERY 2 FT. Use the appropriate fastener for the existing application. (i.e. wood, concrete, or brick construction).

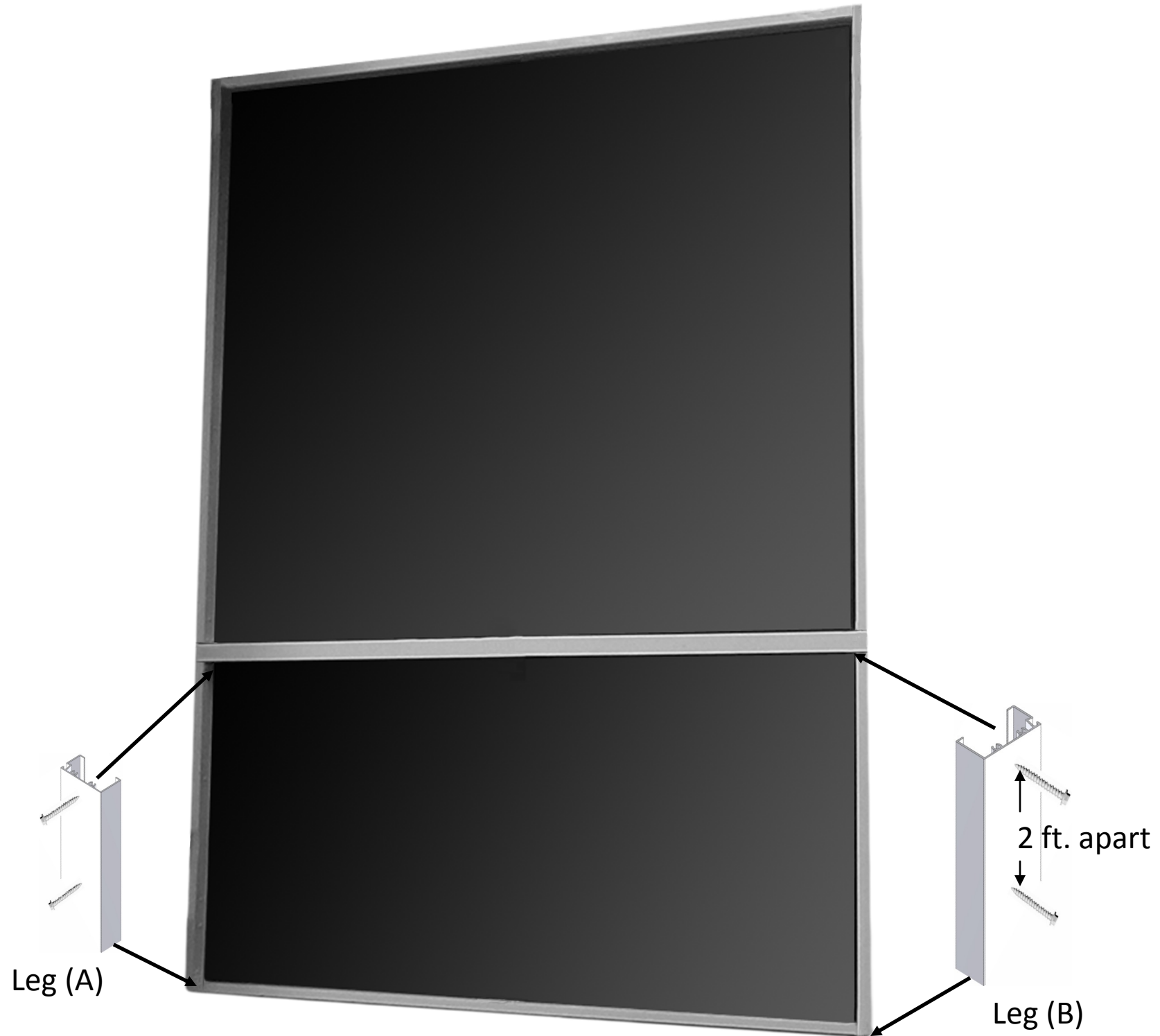

ASSEMBLY continued- THE MIDRAIL:

6. ATTACH MIDRAIL (C) ON TOP OF LEGS (A) AND (B) USING CAPRI CLIPS (F2) AND ½" SELF TAP- PING FASTENERS (F3). See NOTE below prior to installation.

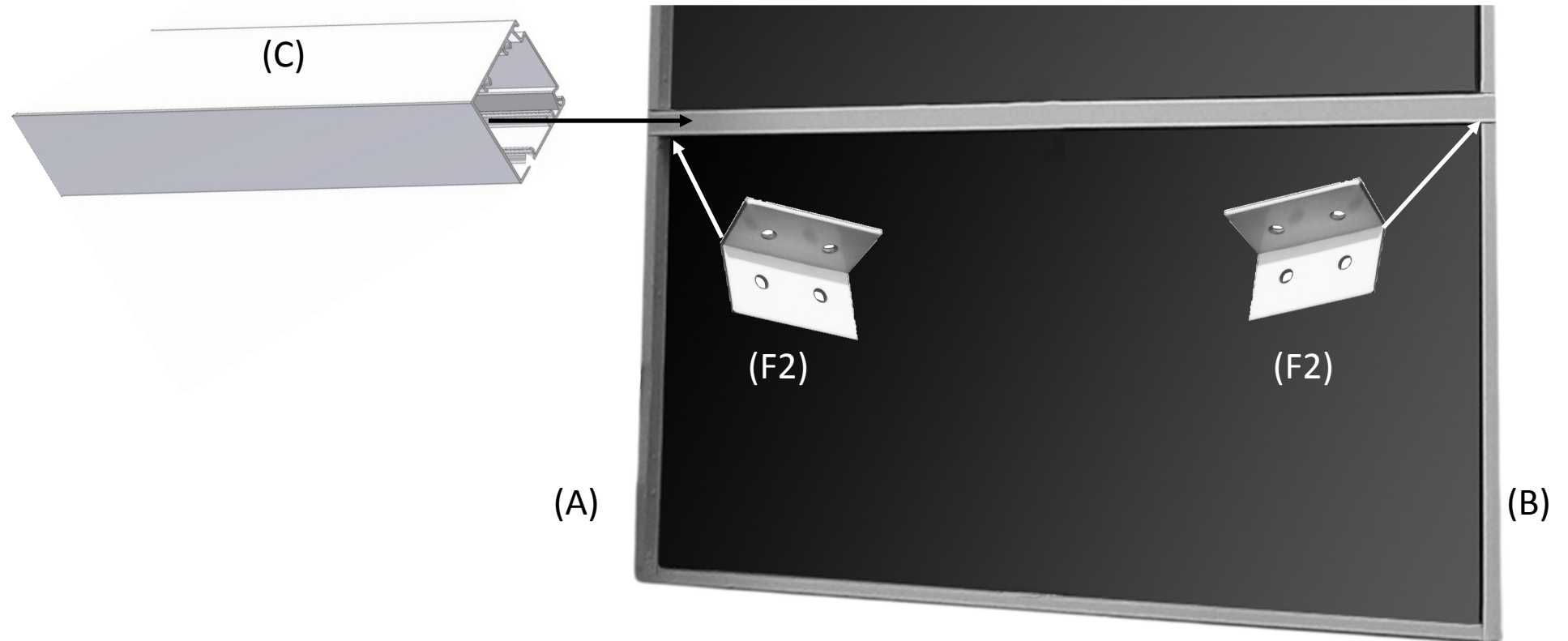

NOTE: When possible, screw 2" fasteners in lower Capri Clip holes and into posts for additional frame strength.

****EXTRA CAPRI CLIPS ARE INCLUDED IN THIS SYSTEM. YOU MAY CHOOSE TO INSTALL CAPRI CLIPS AT ALL MATERIAL INTERSECTIONS, BUT ONLY 2 ARE REQUIRED AS ILLUSTRATED ABOVE FOR LOWER HALF MIDRAIL (C) TO (A) & (B) CONNECTIONS.**



MEASURE, CUT, AND ASSEMBLE- UPPER PANEL:

7. MEASURE, CUT, AND INSTALL UPRIGHT (D) AND (E) TO FIT ON TOP OF MID RAIL (C) AND EXTEND TO TOP OF THE OPENING (CEILING OR HEADER IN MOST CASES.)
 8. FASTEN TO EXISTING POST OR WALL USING APPROPRIATE 2" FASTENERS (F1) . BE SURE TO USE THE APPROPRIATE FASTENER FOR THE APPLICATION. (i.e. wood, concrete, or brick fasteners).
- **IMPORTANT:** Position (D) and (E)'s screen channels to align with (A), (B), and (C) screen channels.

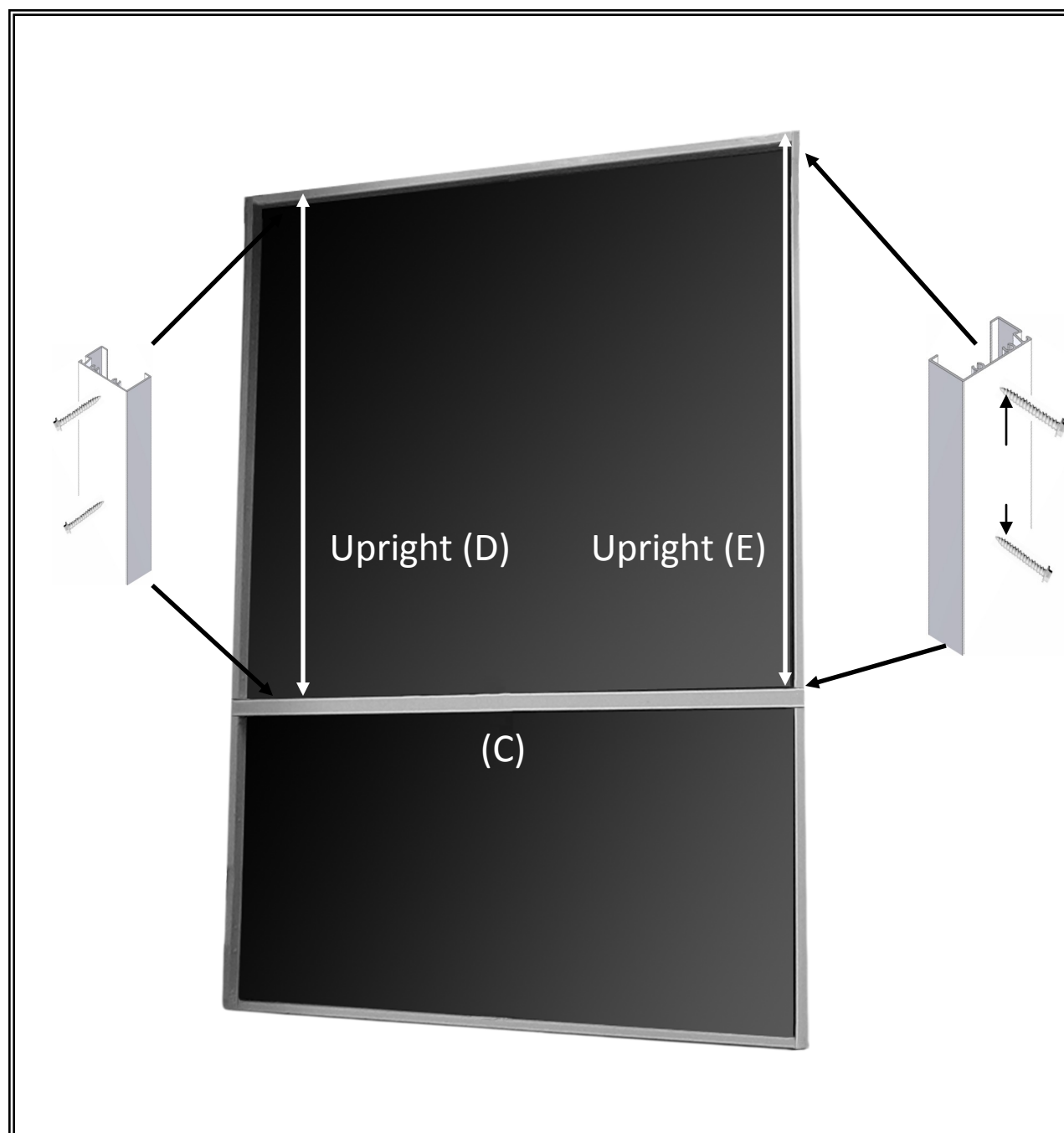

MEASURE, CUT, AND INSTALL- TOP AND BOTTOM CHANNEL:

9. MEASURE AND CUT SECTIONS (F) AND (G) TO FIT HORIZONTALLY AT THE TOP AND BOTTOM OF THE SCREEN WALL. FASTEN USING THE APPROPRIATE (F1) FASTENERS . APPROPRIATE FASTENER FOR THE APPLICATION (i.e. wood, concrete, or brick)
10. INSTALL TOP (F) AND BOTTOM (G) WITH APPROPRIATE 2" FASTENERS (F1) MAKING SURE THE SCREEN CHANNELS ARE POSITIONED APPROPRIATELY.

CONGRATULATIONS, YOUR OPENING SHOULD BE COMPLETELY FRAMED AS PICTURED BELOW.

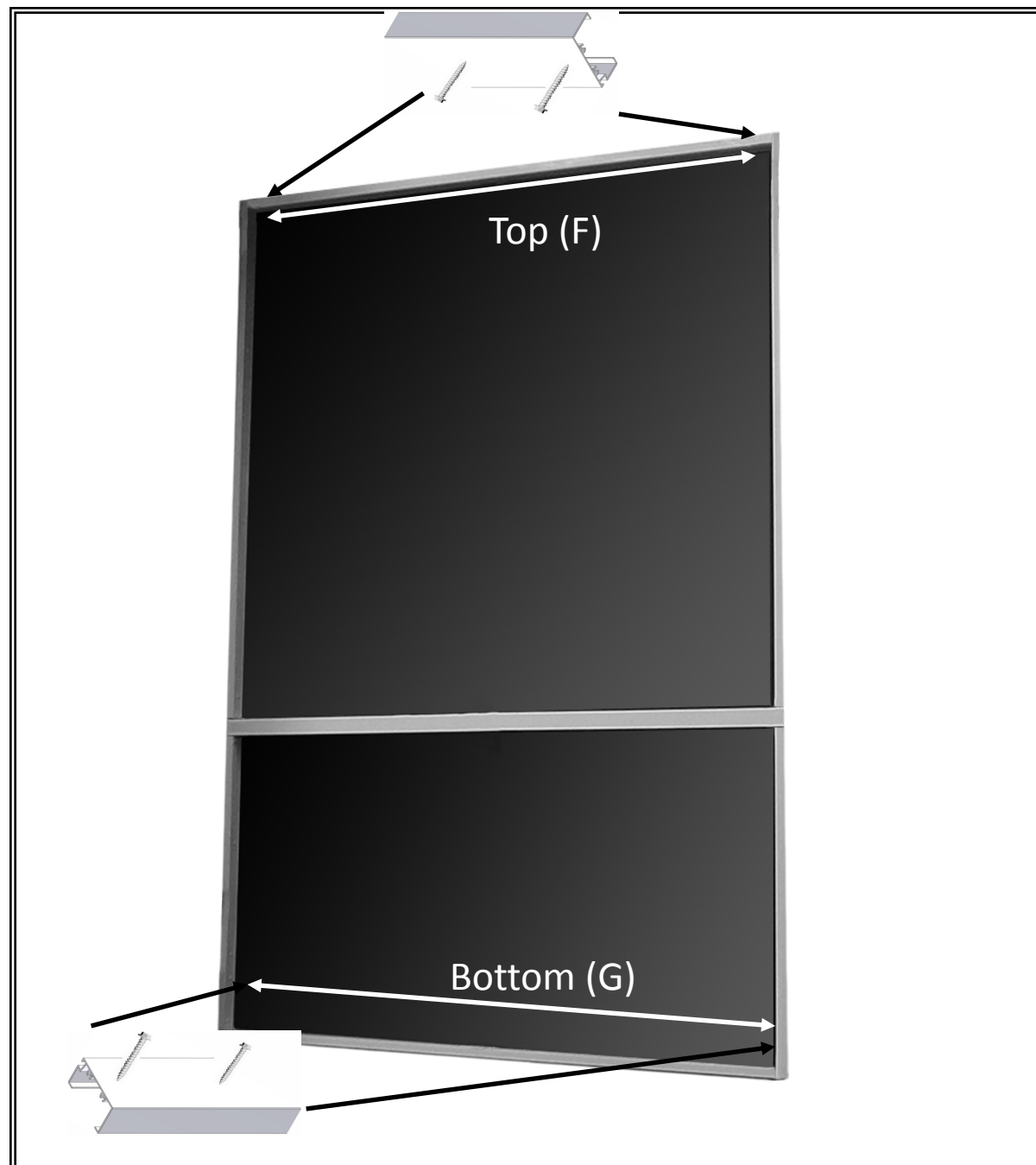

WORKING WITH SCREEN AND SPLINE:

11. NOW IS A GOOD TIME TO PRACTICE HOW THE FLAT SPLINE FITS INTO THE SCREEN CHANNEL. CUT A 6" PIECE OF SPLINE. USING YOUR FINGERS, PUSH THE FLAT SIDE OF THE SPLINE INTO THE DEEPER EDGE OF SPLINE CHANNEL (WITHOUT ANY SCREEN). NOW PRACTICE ROLLING THE SPLINE ROLLER TOOL TO "LOCK" THE SPLINE INTO THE SPLINE CHANNEL. (See illustrations).

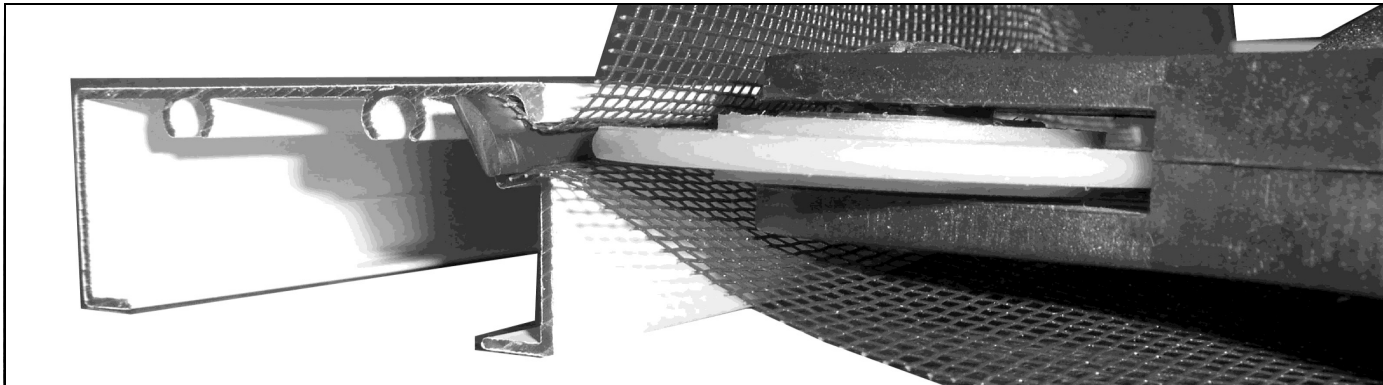

NOTE: "Flat edge" of spline seats in flat edge of channel.



PROPER WHEEL SELECTION FOR SPLINE ROLLING TOOL

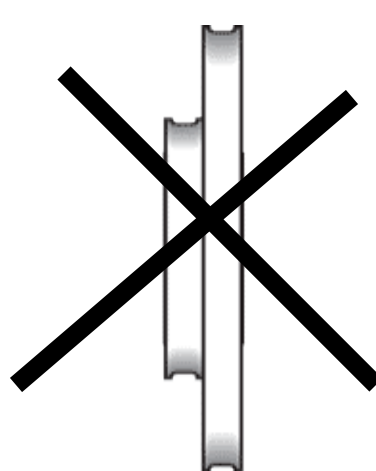

U-shaped wheel



Round wheel

WORKING WITH SCREEN AND SPLINE:

WHEN SCREENING YOUR OPENING, FOLLOW THE DIAGRAM BELOW AS TO THE ORDER IN WHICH TO SCREEN THE CHANNELS, START AT BOTTOM PANEL #1 AND FINISH AT #4. THEN MOVE TO 1-4 OF THE LARGER TOP PANEL. BE SURE TO READ AND UNDERSTAND THIS ENTIRE SECTION BEFORE YOU BEGIN THE SCREENING PROCESS.

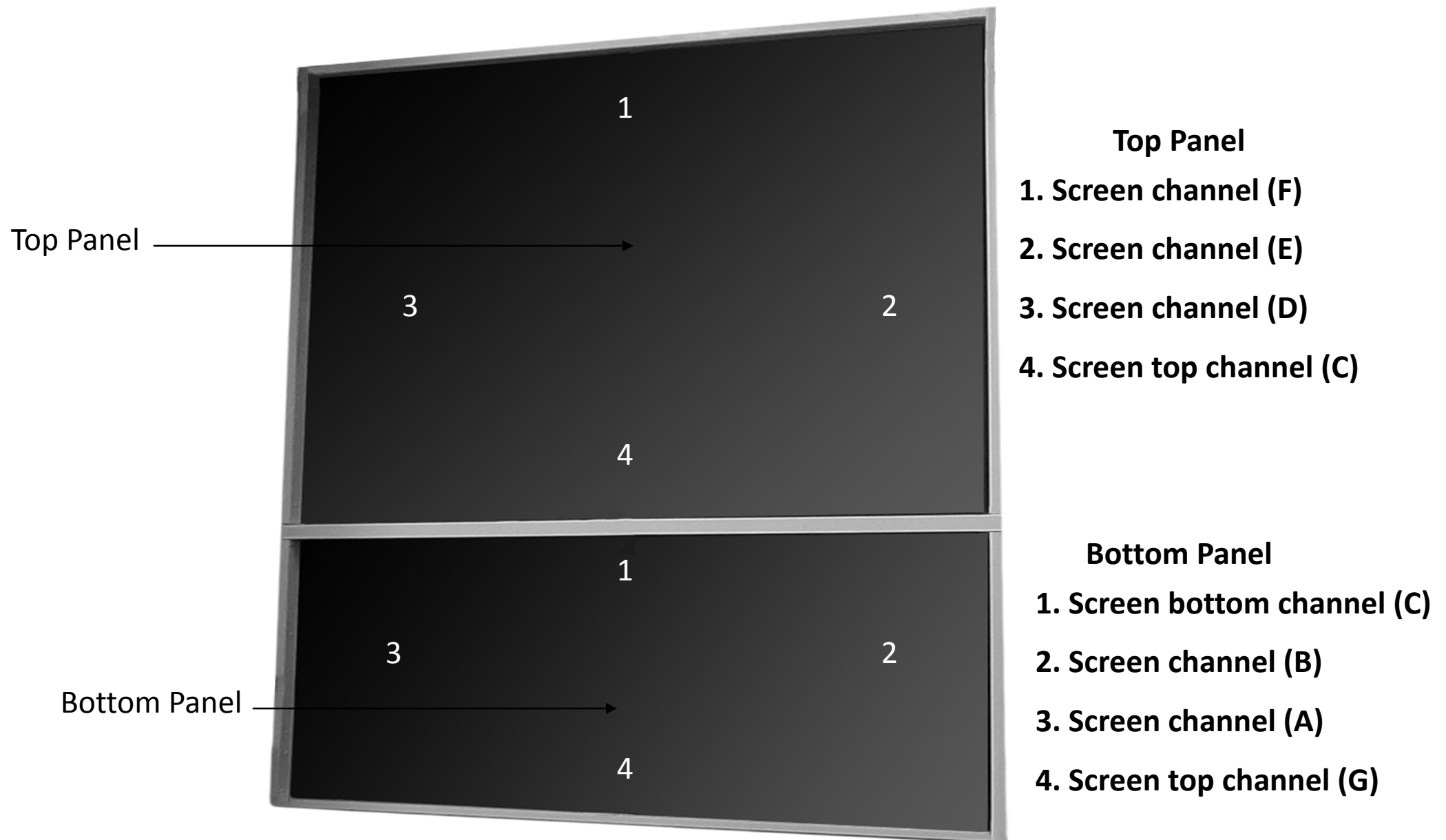

READ PAGES 13, 14, 15, AND 17 BEFORE YOU START!

INSTALLING SCREEN- LOWER PANEL:

12. TAPE OR TACK THE SMALLER BOTTOM PANEL SCREEN (S1) LOOSELY OVER LOWER OPENING (BELOW MIDRAIL). OVERLAP ALL EDGES AT LEAST 3". *Note: Extra screen is supplied.*

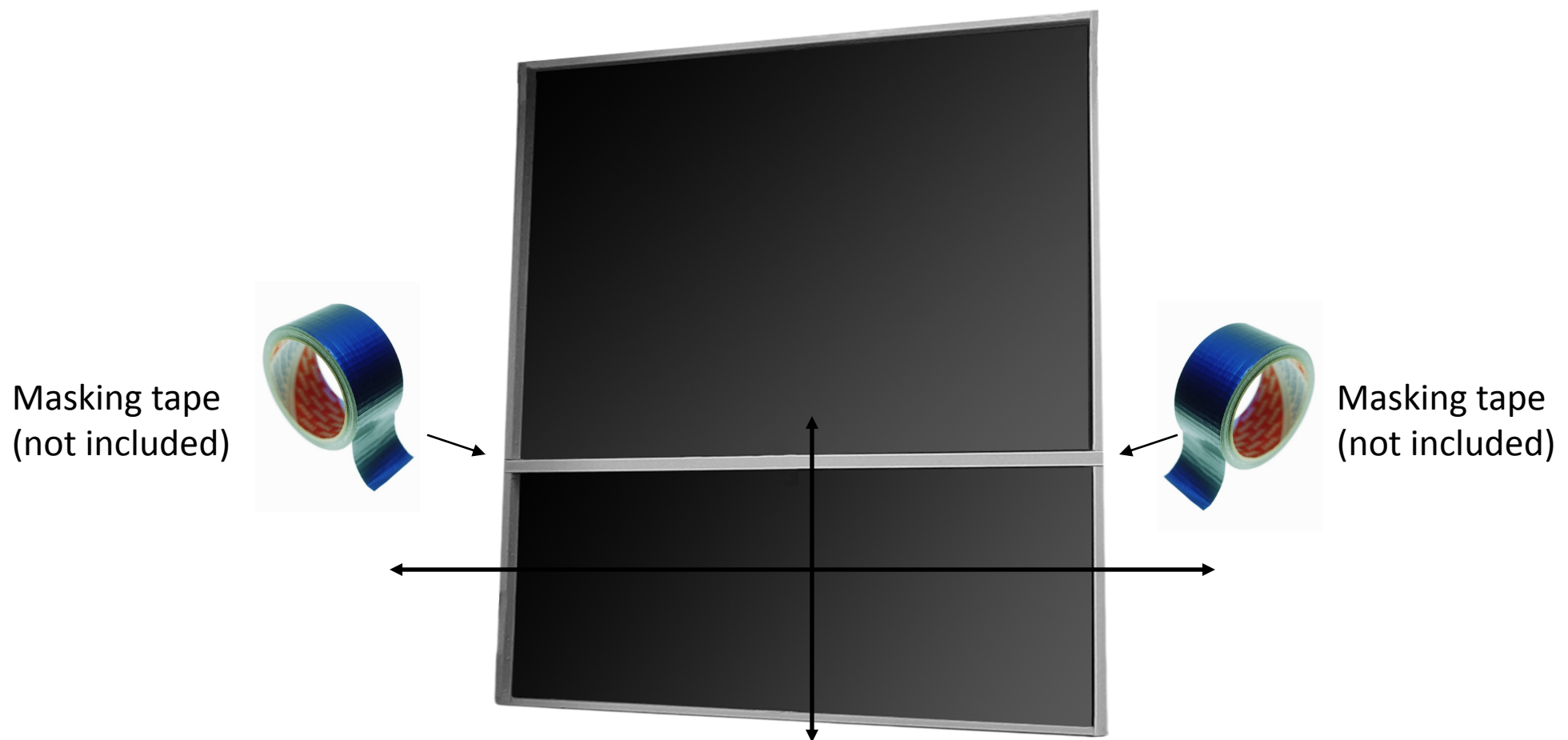

13. USE A PIECE OF 10' SPLINE (S3) TO BEGIN INSTALLING THE LOWER SCREEN PANEL. REFER TO PAGE 12.

INSTALLING SCREEN continued- LOWER PANEL:

14. ALIGN MIDDLE OF SPLINE WITH THE MIDDLE OF THE MIDRAIL (C). ROLL THE SPLINE AND SCREEN INTO THE CHANNEL TOWARDS EITHER CORNER.

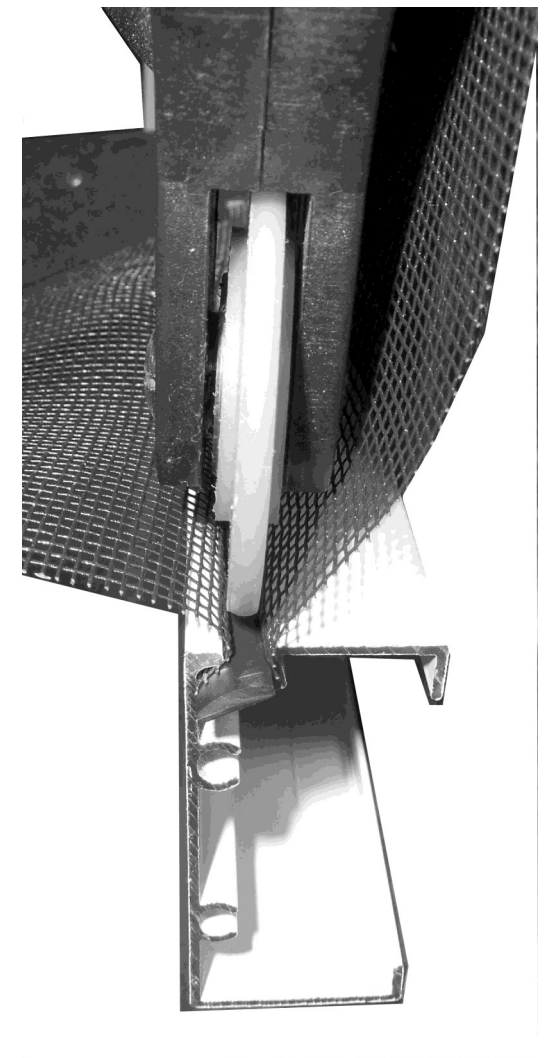
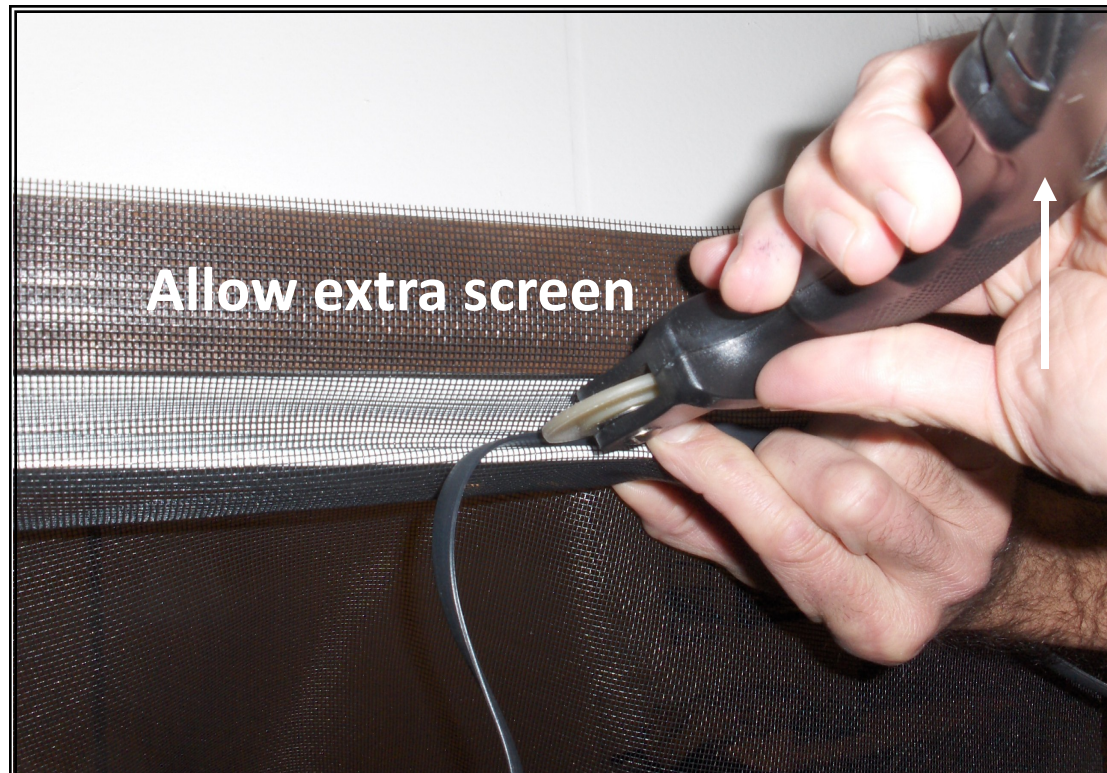

15. MEASURE SIDE (A) AND CUT OFF PIECE OF SPLINE 6" LONGER.

16. STARTING ABOUT 1" BELOW THE UPPER RIGHT CORNER, ROLL THE SPLINE AND SCREEN INTO THE CHANNEL. ENSURE SPLINE COVERS ENTIRE SCREEN CHANNEL.

17. REPEAT STEP 15 FOR SIDE B. APPLY A SLIGHT SIDEWAYS PRESSURE WITH YOUR FINGERS AS YOU ROLL SIDE B.

NOTE: AS THE SPLINE LOCKS INTO PLACE YOUR SCREEN SHOULD BECOME TIGHT. IF NECESSARY PULL OUT SPLINE AND RESTART PROCESS UNTIL YOU ACHIEVE DESIRED LOOK AND SCREEN TAUGHTNESS. REFER TO PG. 7 FOR SIDES (A), (B), AND (C).

INSTALLING SCREEN continued - LOWER AND UPPER PANELS

18. STARTING IN THE MIDDLE OF (F), ROLL THE SPLINE AND SCREEN INTO THE CHANNEL TOWARDS EITHER CORNER. NOW THAT THE TOP (F) IS DONE, COMPLETE BOTH SIDES AS YOU DID WITH THE LOWER PANEL.

NOTE: AS THE SPLINE LOCKS INTO PLACE YOUR SCREEN SHOULD BECOME TIGHT. IF NECESSARY PULL OUT SPLINE AND RESTART PROCESS UNTIL YOU ACHIEVE DESIRED LOOK AND SCREEN TAUGHTNESS.

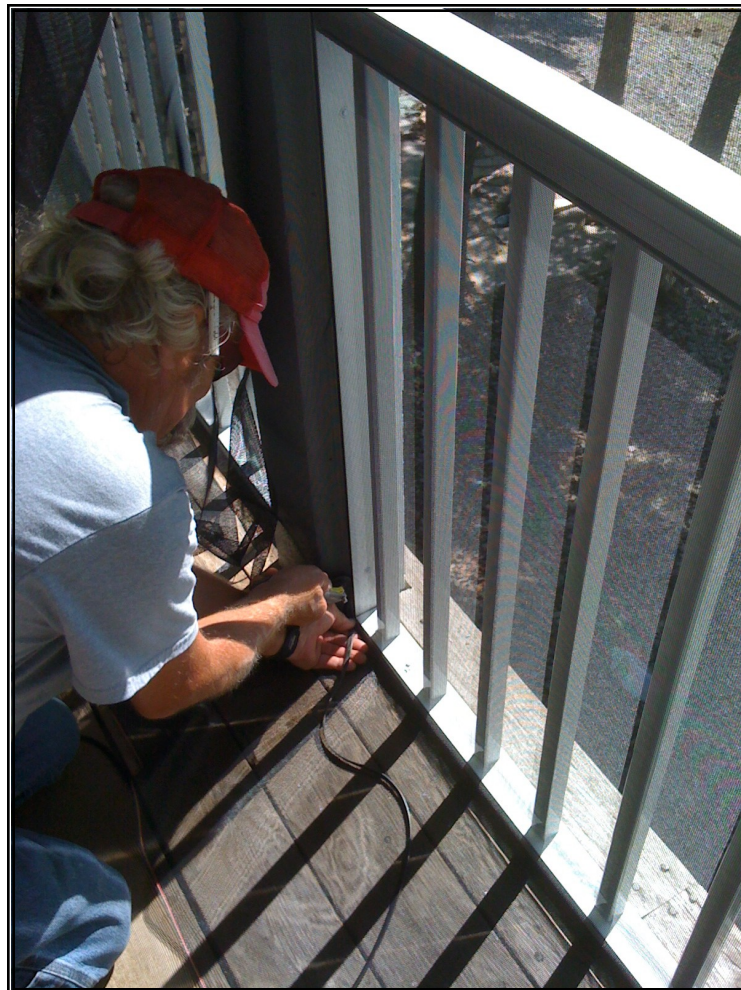

19. REPEAT STEPS 12-18 FOR UPPER PANEL (ABOVE MIDRAIL).

TRIMMING THE SCREEN:

20. CAREFULLY TRIM OFF EXCESS SCREEN THAT IS OUTSIDE THE SPLINE USING A SHARP UTILITY KNIFE.

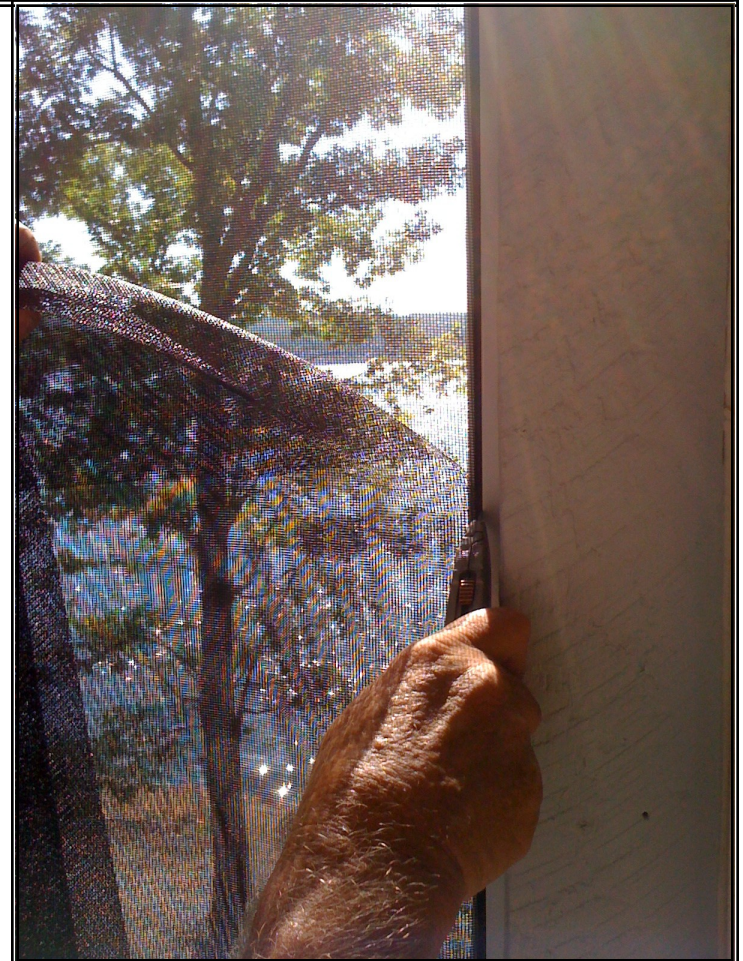

21. TUCK SPLINE INTO CORNERS USING THE TIP OF A SCREWDRIVER.



CONGRATULATIONS, YOUR SCREEN WALL IS NOW COMPLETE!

SCREEN DOOR INSTALLATION



36" Installed Width

80" Installed Height

Left or Right outswing

Mounting fasteners incl.

Powder coated finish

Heavy duty handle

PLANNING & INSTALLING A SCREEN DOOR:

1. Determine screen door location, and remember:

- Most screen doors swing outwards.
- The screen door can be positioned next to existing posts
- A wider screen door is always better
- A right hand screen door is hinged on the right when viewed from the exterior
- A left hand screen door is hinged on the left from when viewed from the exterior

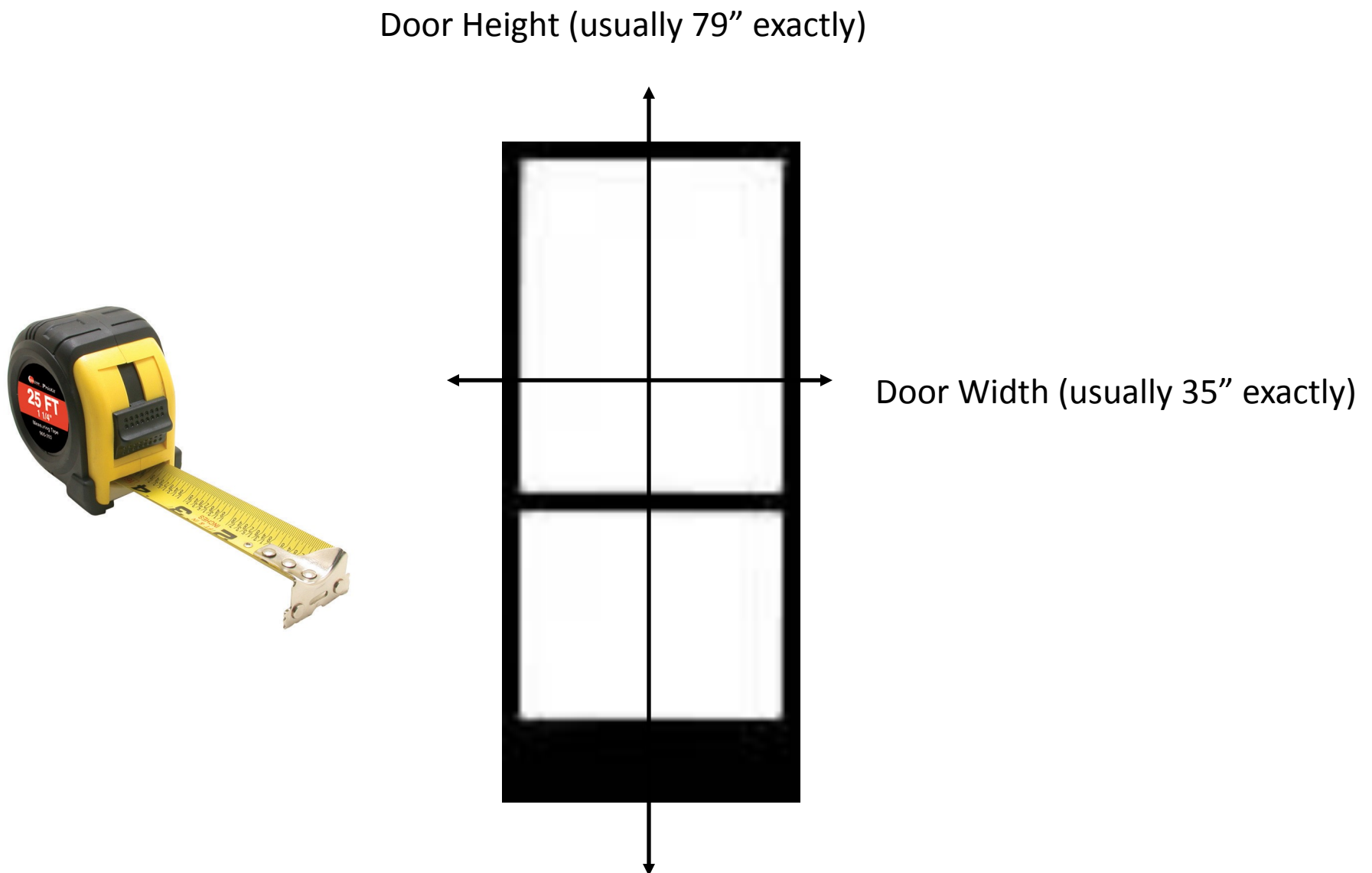

PLANNING & INSTALLING A SCREEN DOOR:

1. Layout contents of the EZ Screen Room Door Frame Kit and review all of the installation steps. Notice how similar constructing the door frame is to the screen wall—the midrail has now become the door header.

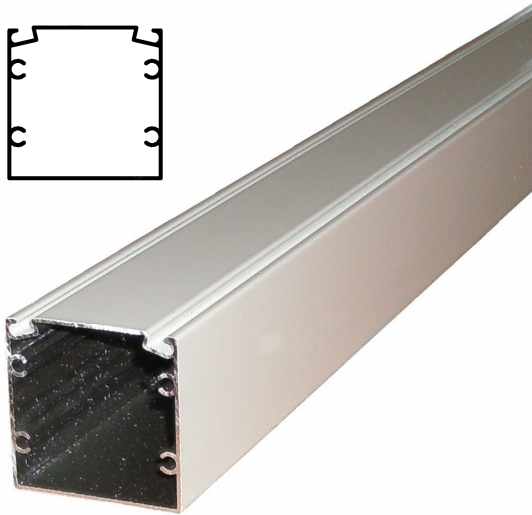

2x2 Post — Part (C1,C2,C3,C4,C5)



Capri Clip— Part (F2)



Fasteners: 2" (F1) , 1/2" ST (F3)

Packing List:

Qty	Length	Description
4	8 ft	2x2 in. post w/ dual screen channels (Part# C)
8	2 in	Capri Clips (Part# F2)
10	12 ft	Spline (Part# S3)
50	1/2 in	Self tapping fasteners (Part# F3)
30	2 in	Hex head metal/wood fastener (Part# F1)
20	3 in	Hex head metal/wood fastener (Part# F4)
20	4 in	Hex head metal/wood fastener (Part# F5)
20	2 1/4 in	Concrete fastener (Part# F6)

DOOR FRAME CONSTRUCTION OVERVIEW

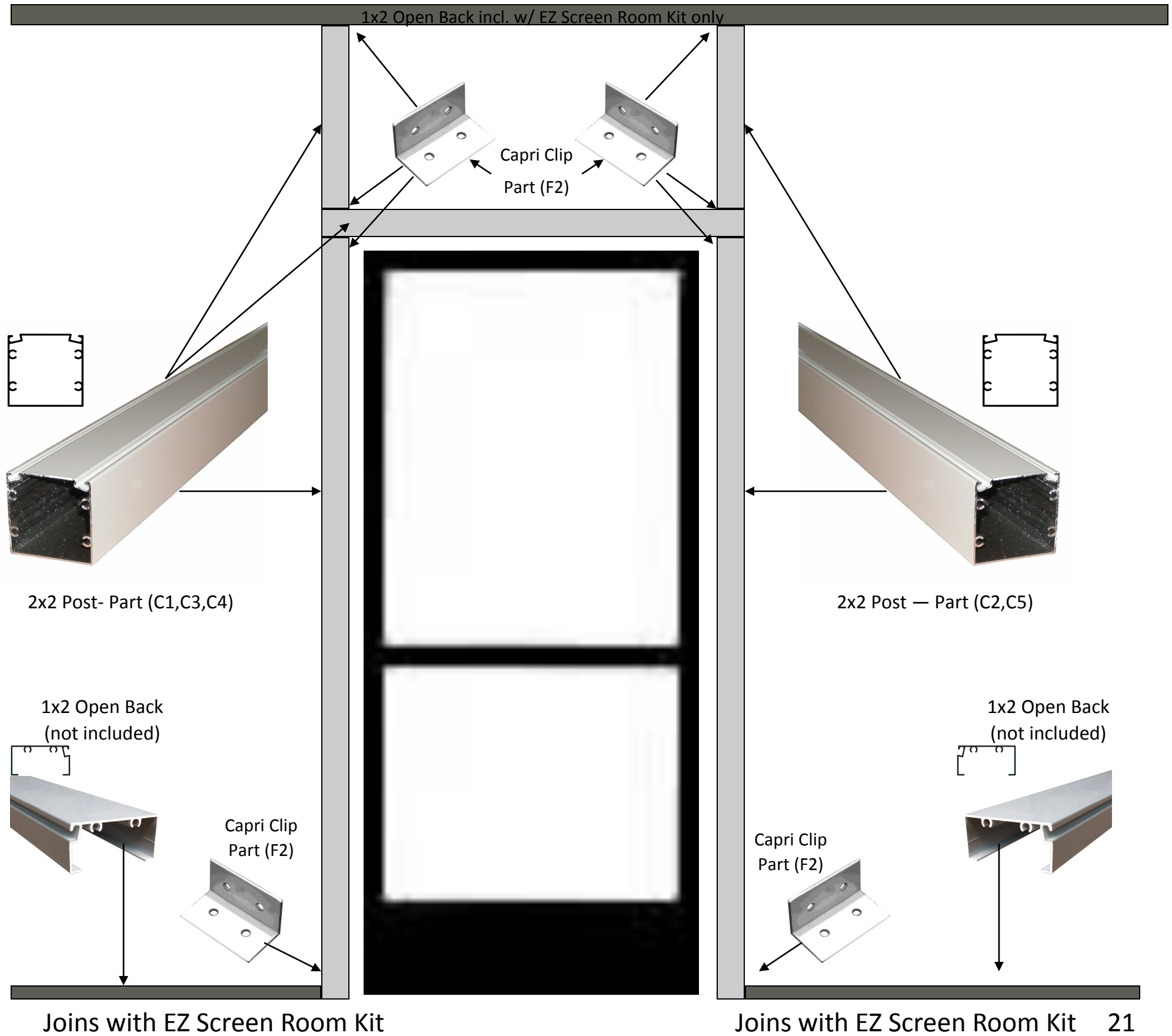

CONSTRUCTING THE DOOR FRAME

Cut C1 and C2 one inch greater than the height of the screen door. Example: If the screen door is 79" then cut C1 and C2 at exactly 80".

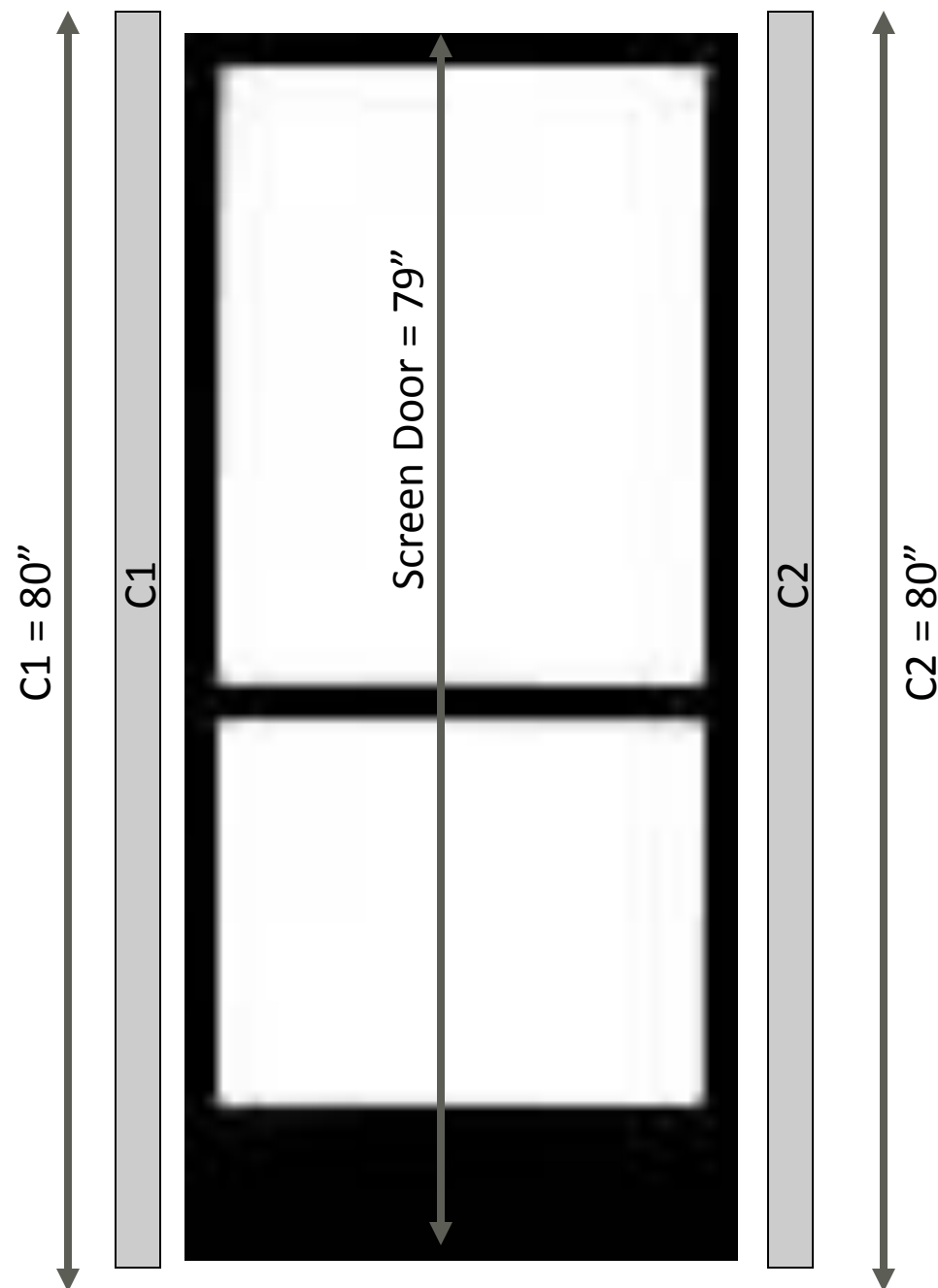

CONSTRUCTING THE DOOR FRAME

Cut C3 **FIVE (5) inches greater** than the width of the screen door. *Example:* If the screen door width is 35" then cut C3 at exactly 40". This ensures the header will cover the top of C1 and C2 and gives a 1/2" clearance on each side of the screen door.

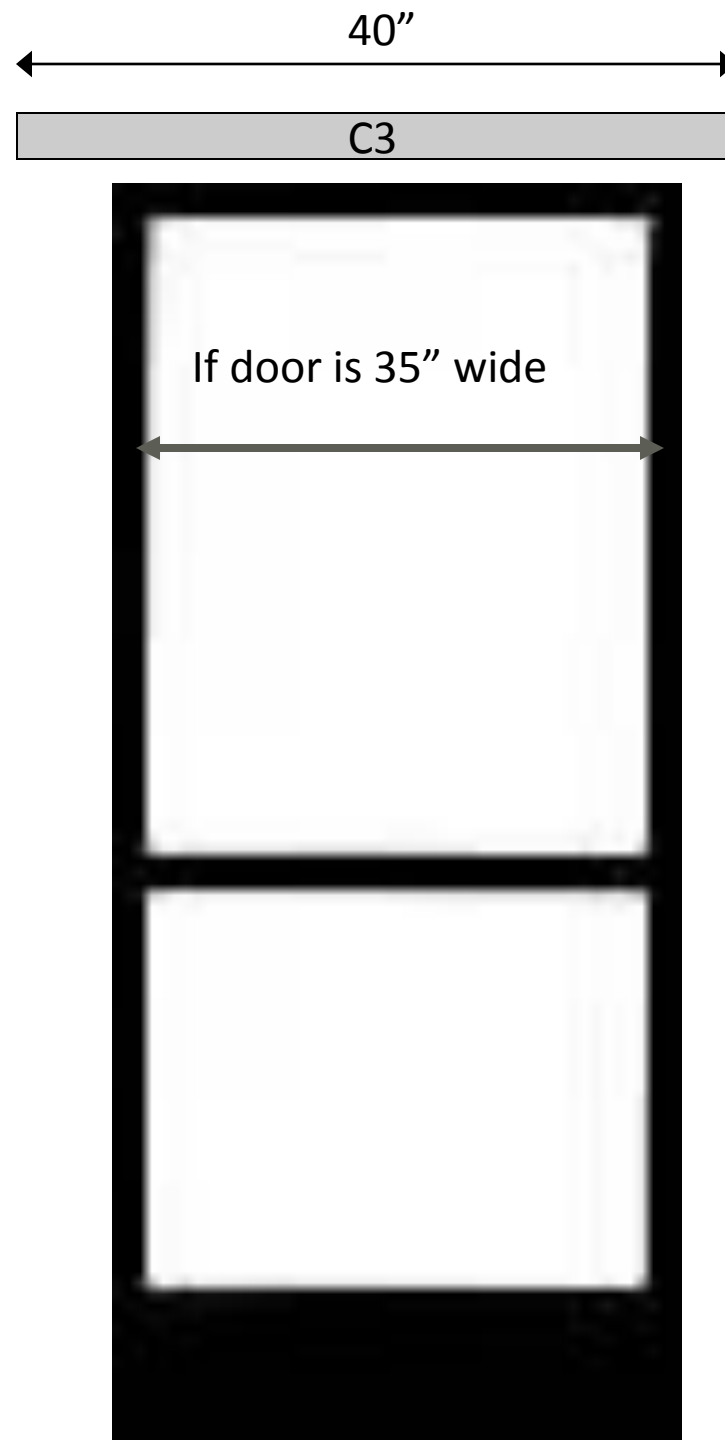

CONSTRUCTING THE DOOR FRAME

Assemble C1,C2, and C3 using (2) Capri Clips (F2) and fasteners (F3).

The frame will be 1 in. wider and 1 in. taller than your door size. Use your square to ensure the frame is true.

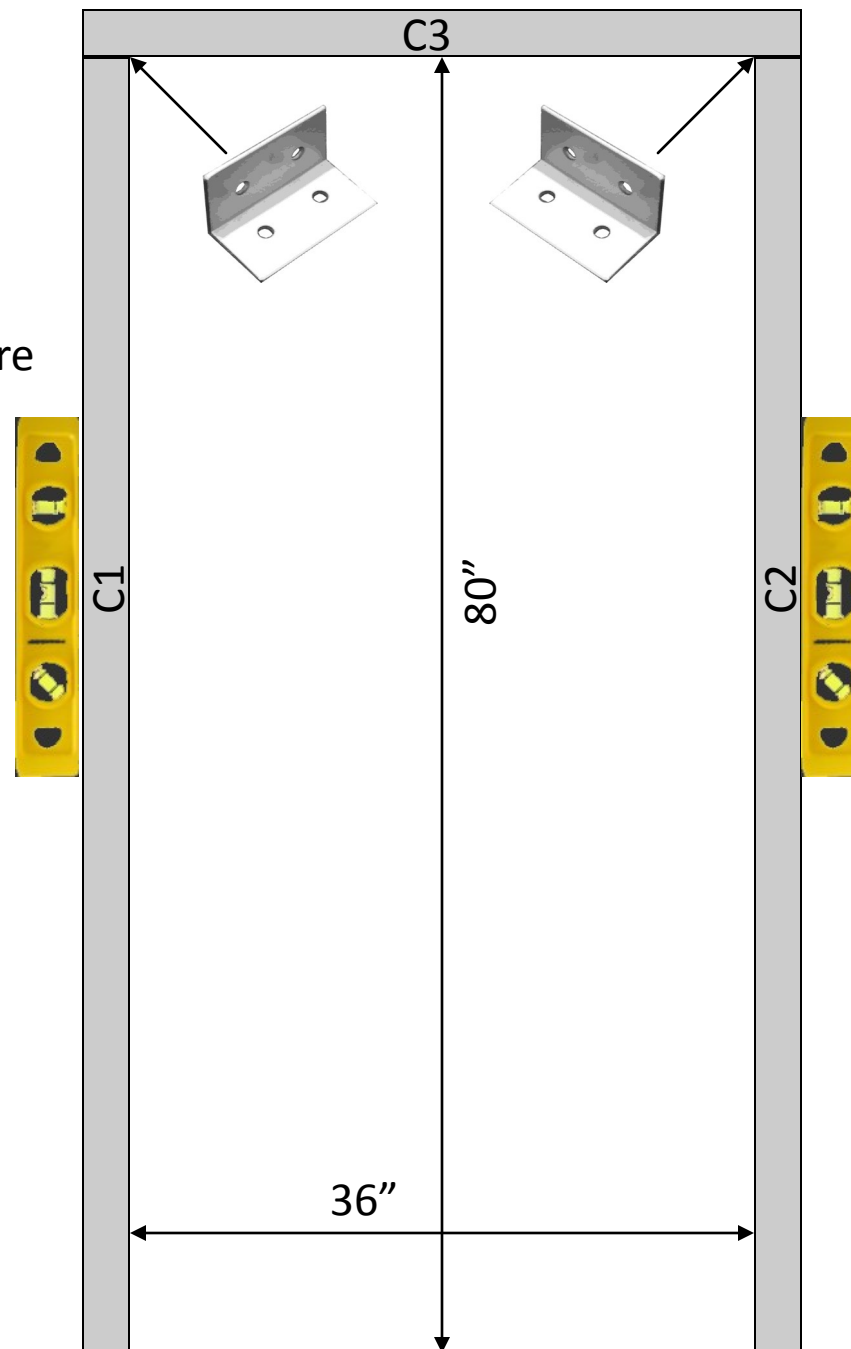

CONSTRUCTING THE DOOR FRAME

Assemble C3,C4, and C5 using (4) Capri Clips (F2) and fasteners (F3).

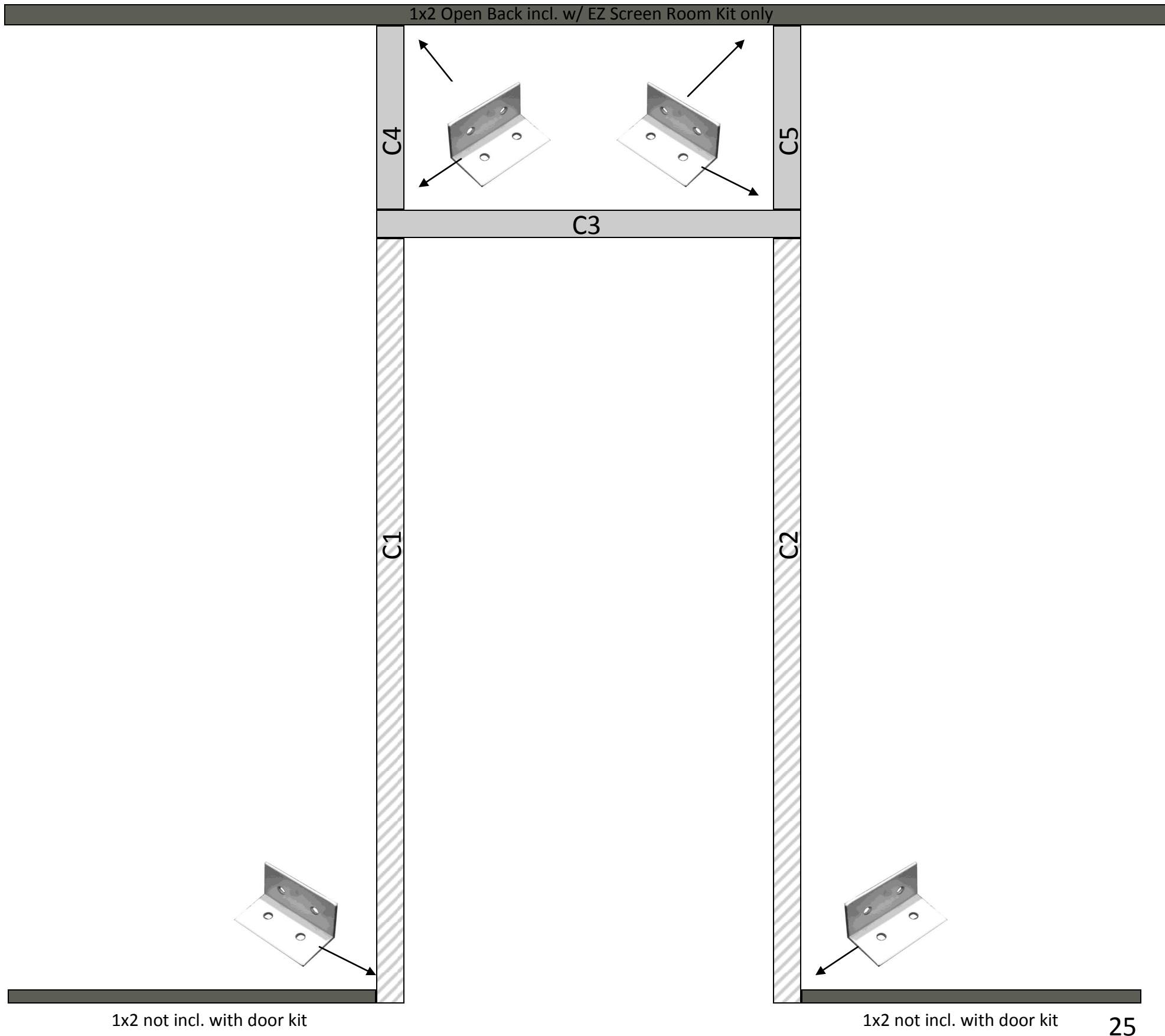

CONSTRUCTING THE DOOR FRAME

Attach hinges to door and frame (*refer to screen door installation instructions provided by your screen door manufacturer*). MAKE SURE DOOR IS LEVEL AND SWINGS FREELY.

1x2 Open Back incl. w/ EZ Screen Room Kit



Attach door handle and swing arm. (*Refer to screen door installation instructions provided by screen door manufacturer.*)

DOOR FRAME IS COMPLETE

Thank you for choosing EZ Screen Room to construct your outdoor enclosure. We look forward to your continued patronage. Take a look at the additional EZ Products available at your favorite building materials supplier:

- **EZ Handrail** — Code compliant picket railing



- **EZ Handrail Glass Edition** — 8" glass slat railing



- **EZ ADA Handrail** — Code compliant 1.9" round tube handrail

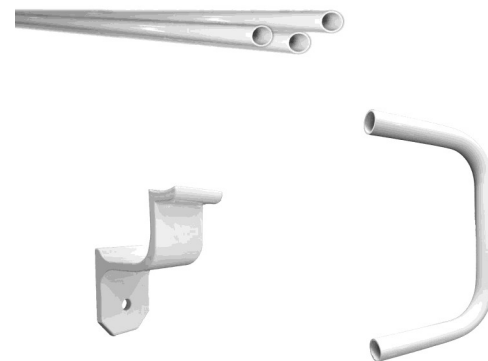

Vendor No: 60083341

S/O SKU: 516-036

THE HOME DEPOT

EZ SCREEN ROOM SUPPORT TEAM

Here are some friendly faces of your support team



CORY



MARY ANNE



DAN

- **NO AUTOMATED PHONE PROMPTS**
- **SPEAK DIRECTLY WITH THE SUPPORT TEAM**
- **M-F 7am—4pm CST**
- **3-4 DAY LEAD TIMES TO ALL 48 STATES**
- **ORDERS SHIP SAME/NEXT DAY**

[Www.HDezhandrail.com](http://www.HDezhandrail.com)

Vendor No: 60083341

S/O SKU: 516-036