

GoWISEUSA®

ELECTRIC AIR FRYER USER MANUAL

Model No.: GW22954/GW22955/
GW22956/GW22957



Please read through this manual carefully before use

 **IMPORTANT SAFEGUARDS AND TIPS**

WWW.GOWISEUSA.COM

THANK YOU FOR YOUR PURCHASE!

Join

the GoWISE Community on Facebook, Instagram, Twitter, and Pinterest for updates, tips, and great deals!



Explore

recipes on our recipe App or www.gowiseproducts.com/blogs/recipes



Contact Our Customer Care Team

855-233-9199

support@gowiseusa.com

Live Chat at gowiseusa.com

M-F 8:30am - 4:00pm MST



Register Your Product

www.gowiseproducts.com/apps/product-registration

(The serial number is normally underneath the product. Please check there first.)



Specifications

Voltage: 120V, 60Hz

Watts: 1700W

Capacity: 7 Qt

Temp. Range: 90°F-400°F



TABLE OF CONTENTS

Register Your Product.....	2
Specifications.....	2
Important Safeguards.....	4
Electromagnetic Fields (EMF).....	5
Product Structure.....	6
Control Display.....	7
Cooking Functions Reference.....	8
Set Up and Using Your Air Fryer.....	9
Before First Use.....	9
Using Your Air Fryer.....	10
Cooking Guide.....	12
Cooking Chart.....	12
Internal Temperature Chart.....	13
Tips.....	13
Cleaning Your Air Fryer.....	14
Troubleshooting.....	15
Warranty.....	16

IMPORTANT SAFEGUARDS

HOUSEHOLD USE ONLY • READ ALL INSTRUCTIONS BEFORE USE

- 1. READ THE ENTIRE MANUAL BEFORE ATTEMPTING TO OPERATE.**
2. Keep the box and packing material for storage.
- 3. DO NOT PLACE** the appliance on stove top surfaces.
4. This appliance has a polarized plug (one prong is wider than the other). This plug is intended to fit into a polarized outlet only one way. **TO AVOID ELECTRIC SHOCK, DO NOT** force the plug into the outlet if it does not fit. If the plug does not fit fully into the outlet, reverse the plug. If it still does not fit, contact a qualified electrician. **DO NOT ATTEMPT** to modify the plug in any way.
- 5. DO NOT** immerse the power cord, plug, or any part of the appliance in water or any other liquids to avoid electric shock.
- 6. DO NOT** use the appliance if the plug, the power cord, or the appliance itself is damaged in any way.
- 7. ALWAYS** keep the power cord away from hot surfaces.
- 8. DO NOT** go to any unauthorized person to replace or fix the appliance.
- 9. DO NOT** plug the appliance in or operate the appliance with wet hands.
- 10. DO NOT** connect the appliance to an external timer switch or separate remote control system.
- 11. DO NOT PLACE** the appliance against a wall or any other appliances. Leave at least five inches of free space along the back, sides, and above the appliance.
- 12. DO NOT PLACE** anything on top of the appliance.
- 13. DO NOT PLACE** the appliance on or near combustible materials, such as a tablecloth or curtain.
- 14. DO NOT USE** the **GoWISE USA Air Fryer** for any purpose other than described in this manual.
- 15. NEVER OPERATE** the appliance unattended.
- 16.** This appliance is **NOT INTENDED FOR USE** by persons with reduced physical, sensory, or mental capabilities or persons with a lack of experience and knowledge unless they are **UNDER THE SUPERVISION** of a responsible person or have been given proper instruction to use the appliance. This appliance is **NOT INTENDED FOR USE** by children. Make sure that the appliance is out of reach of children, especially when it is operating.
- 17.** Keep all the ingredients within the basket to prevent any contact with the heating elements. **DO NOT OVERFILL** the basket.
- 18. DO NOT** fill the basket with oil. Filling the basket with oil is a fire hazard.

IMPORTANT SAFEGUARDS

HOUSEHOLD USE ONLY • READ ALL INSTRUCTIONS BEFORE USE

19. DO NOT COVER OR BLOCK

the air inlet and outlet while the appliance is in operation. Doing so prevents even cooking and may damage the unit or cause it to overheat.

20. DO NOT touch the inside of the appliance while it is operating.

21. While air frying, hot air is released through the air outlet openings. Keep your hands and face at a safe distance from the steam and from the air outlet opening. **BE CAUTIOUS** of hot steam and air when you remove the basket from the appliance. Any accessible surface may become hot during use.

22. **IMMEDIATELY UNPLUG** the appliance if you see dark smoke coming out of the appliance. Wait for the smoke emission to stop before you remove the basket from the appliance.

23. **ENSURE** that the appliance is placed and operated on a horizontal, even, stable, and noncombustible surface.

24. This appliance is designed for **HOUSEHOLD USE ONLY**. It is not safe to use in environments, such as staff kitchens, farms, motels, and other non-residential environments.

25. If the **GoWISE USA Air Fryer** is used improperly, for professional or semi-professional purposes, or if it is not used according to the instructions in this user manual,

the warranty becomes invalid, and the manufacturer will not be held liable for damages.

26. **ALWAYS** unplug the appliance after use.

27. **ALWAYS** wait 30 minutes for the appliance to cool down before handling, cleaning, or storing.

28. The base of the **GoWISE USA Air Fryer** vents heat during the cooking process. Artificial stone countertops are not heat-resistant. It is the end user's responsibility to verify the heat capacity of their countertops. We recommend using a silicone pad or spare, non-artificial tile to protect your counters from heat damage. **The care and use of countertops is the responsibility of the end user.**

Electromagnetic Fields (EMF)

This appliance complies with all standards regarding Electromagnetic Fields (EMF). Under proper handling, the appliance is safe to use based on available scientific evidence.

**SAVE THESE
INSTRUCTIONS**

PRODUCT STRUCTURE

PARTS

1. Air Inlet
2. LCD Control Display
3. Crisper Tray
4. Fry Basket
5. Handle
6. Air Outlet

ACCESSORIES

Stackable Mesh Racks x3

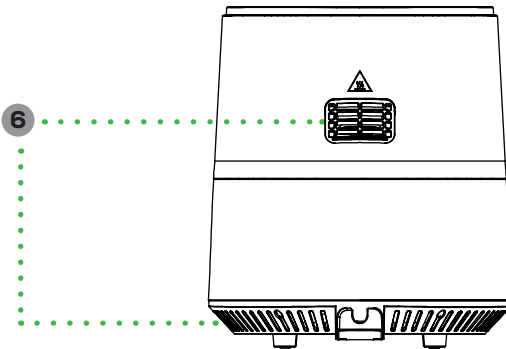
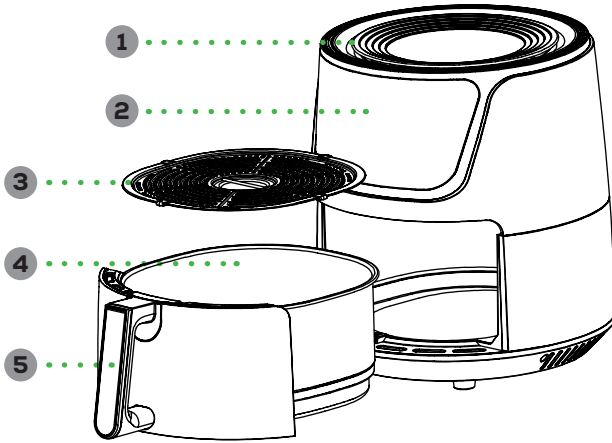
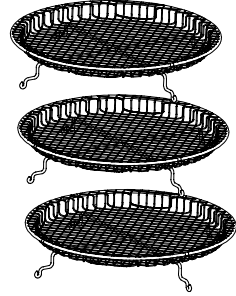

CONTROL DISPLAY



OPERATING BUTTONS

POWER/START/PAUSE: Powers the unit on and off; starts and pauses the cooking process

UP & DOWN arrows: Increase or decrease temperature and time

*All functions aside from Dehydrate have adjustable time in 1-minute increments between 1-60 minutes, and adjustable temperature in 5-degree increments between 180°F – 400°F.

FUNCTION BUTTONS

Air Fry: 15 minutes at 400°F

Roast: 20 minutes at 350°F

Broil: 10 minutes at 400°F

Dehydrate: 4 hours at 130°F

Grill: 20 minutes at 370°F

Bake: 25 minutes at 350°F

Reheat: 5 minutes at 320°F

Keep Warm: 30 minutes at 180°F

*Dehydrate can be adjusted in 30-minute increments between 2-24 hours, and temperature can be adjusted in 5-degree increments between 90°F – 170°F.

COOKING FUNCTIONS REFERENCE

This Air Fryer is equipped with a full touchscreen display with one-touch cooking functions. To select a function, simply press the associated icon. Time and temperature are adjustable on all functions. See default settings for each function, along with their adjustable ranges in the chart below.

Function	Description	Default Time	Default Temp	Range
Air Fry	Give food a crispy crunch similar to a fried texture, but with little to no oil.	15 min	400°F	1-60 minutes, 180°F - 400°F
Roast	Make tender meats and vegetables as if you roasted them in the oven.	20 min	350°F	1-60 minutes, 180°F - 400°F
Broil	Brown food to perfection using the Broil setting and double rack.	10 min	400°F	1-60 minutes, 180°F - 400°F
Dehydrate	Create healthy snacks like dried fruits and veggies or beef jerky.	4 hr	130°F	2-24 hours, 90°F - 170°F
Grill	Get a grilled food taste in your Air Fryer. Use an included mesh rack or purchase a skewer accessory rack.	20 min	370°F	1-60 minutes, 180°F - 400°F
Bake	Bake faster and without heating up your whole kitchen.	25 min	350°F	1-60 minutes, 180°F - 400°F
Reheat	Ditch your microwave - your air fryer will bring your leftovers back to life.	5 min	320°F	1-60 minutes, 180°F - 400°F
Keep Warm	Use by itself or with another function to ensure food stays warm when the cooking cycle ends. *	30 min	180°F	1-60 minutes, 180°F - 400°F

***NOTE:** The Keep Warm function can be added onto any cooking function (except Dehydrate) by pressing the Keep Warm icon after selecting another cooking function. Both function icons will blink to indicate they are activated. When the first

cooking function is complete, the Air Fryer will automatically switch to the Keep Warm function default (180°F for 30 minutes). Keep Warm can be added or removed at any point during the cooking cycle without pausing or restarting the unit.

SET UP AND USING YOUR AIR FRYER

BEFORE FIRST USE



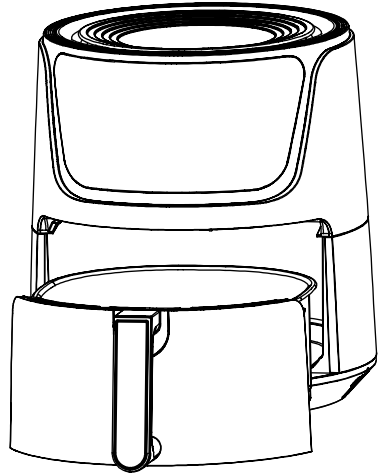





- 1.** Remove all packaging materials, stickers, and labels.
- 2.** Clean the basket, crisper tray, and accessories with hot water, soap, and a non-abrasive sponge.
- 3.** Wipe the inside and outside of the appliance with a clean cloth.
- 4.** Set the unit to 350°F for about 5 minutes. This process will burn off any remaining residue left from the manufacturer. There may be a slight burning smell which will dissipate after a few minutes.
- 5.** Your new GoWISE USA Air Fryer is now ready for use!



NOTE: DO NOT fill basket with oil or lard. The appliance uses rapid air circulation to fry.

SET UP AND USING YOUR AIR FRYER

USING YOUR AIR FRYER

1. Place the air fryer on a flat and even surface. **DO NOT PLACE THE AIR FRYER ON A SURFACE THAT IS NOT HEAT RESISTANT. DO NOT PLACE THE AIR FRYER ON STOVE TOP SURFACES.**
2. Grab the handle in the middle of the crisper tray and place it in the fry basket. **DO NOT FILL THE BASKET WITH OIL OR ANY OTHER LIQUID.**
3. Place the ingredients in the fry basket and then slide the basket back into the appliance. The  button on the LCD display should light up.
4. Press the  button and select a cooking function by pressing the icon of the function.
5. Adjust the time and temperature as needed using the “^” or “v” arrows. Function time (aside from Dehydrate) can be adjusted in 1-minute increments between 1-60 minutes. Function temperature (aside from Dehydrate) can be adjusted in 5-degree increments between 180°F – 400°F. Hold down the “^” or “v” arrow keys to move through the time and temperature options quicker.
NOTE: By default, your air fryer will be set to cook at 370°F for 15 minutes when you first slide the basket into the unit. You can adjust the time or temperature from this default screen as well without selecting a cooking function.
6. Once you have set the time and temperature and selected a cooking function (optional), press the  button again to start the cooking cycle. The  and  icons will illuminate to indicate that the air fryer is heating and the fan is circulating.
7. If you would like to make changes at any point throughout the cooking cycle, such as adding more time, increasing temperature, or changing to a new function, press the  button. The fan will continue circulating, but the heating element will shut off as indicated by the  and  icons. Make your adjustments and tap the  button again to resume.
8. You may need to shake the ingredients midway through the cooking cycle to ensure even cooking. Pull the basket out of the air fryer by the handle (the air fryer will automatically power down), and carefully shake the ingredients inside the basket.
NOTE: If the power is cut off, or if the unit is unplugged mid-cooking cycle, the unit will retain the last settings from prior to the power loss for up to 2 hours.
9. Slide the basket back into the air fryer by carefully aligning the track inside the air fryer with the rim of the basket. The fryer will resume the cooking cycle.
10. When the cooking cycle is done, the timer will beep five times and

SET UP AND USING YOUR AIR FRYER

USING YOUR AIR FRYER

the display will read OFF (unless the Keep Warm function has been activated). The  icon will remain illuminated as it continues to run and cool down the air fryer. The fan will stop shortly after the timer beeps again (approximately 20 seconds).

NOTE: If the Keep Warm function had been selected, the unit will beep once and switch over to the default Keep Warm settings (180°F for 30 minutes) after the first cooking cycle has completed.

- 11.** If you need to turn the unit off before the end of the cooking cycle, hold down the  button for 3 seconds. The display will read OFF and the fan may continue to run up to 20 seconds.
- 12.** Slide the basket out of the fryer and place it on a pot holder.
NOTE: Oil from the ingredients will gather in the bottom of the basket. Be careful when sliding the basket out of the fryer.
- 13.** To remove the ingredients, use silicone tipped tongs, or carefully pour ingredients out of the fry basket onto a plate.
- 14.** If using tongs or any other cooking utensils, make sure to use non-abrasive, non-metal tongs to avoid scratching the ceramic coating on the fry basket and the crisper tray.

To order replacement parts please contact our Customer Care Team.

855-233-9199

support@gowiseusa.com

Live Chat at gowiseusa.com

M-F 8:30am - 4:00pm MST

COOKING GUIDE

This chart will help you set the time and temperature for certain foods.

Food	Time	Temperature	Shake/Flip	Tips
Potatoes & Fries				
Thin Frozen Fries	9-16 min	400°F	Shake	Add 1/2 Tbsp of oil to food
Thick Frozen Fries	11-20 min	400°F	Shake	
Homemade Fries	16-20 min	400°F	Shake	
Homemade Potato Wedges	18-22 min	360°F	Shake	
Homemade Potato Cubes	12-18 min	360°F	Shake	
Falafel	15 min	360°F	Shake	
Potato Gratin	15-18 min	400°F	Shake	
Meat & Poultry				
Steak	8-12 min	360°F	Flip	Line basket with foil or liner
Pork Chops	10-14 min	360°F	Flip	
Hamburger	7-14 min	360°F	Flip	
Sausage Roll	13-15 min	400°F	Flip	
Drumsticks	18-22 min	360°F	Flip	
Chicken Breast	10-15 min	360°F	Flip	
Snacks				
Spring Rolls	8-10 min	400°F	Shake	/
Frozen Chicken Nuggets	6-10 min	400°F	Shake	
Frozen Fish Sticks	6-10 min	400°F	Shake	
Frozen Mozzarella Sticks	8-10 min	360°F	Shake	
Stuffed Vegetables	10 min	320°F	Shake	
Baking				
Cake	20-25 min	320°F	/	Use baking pan (not included)
Quiche	20-22 min	360°F	/	
Muffins	15-18 min	400°F	/	
Sweet Snacks	20 min	320°F	/	

COOKING GUIDE

INTERNAL TEMPERATURE CHART

This chart should be used to check the temperature of cooked meats. Always review USDA Food Safety Standards.

Food	Type	Internal Temperature
Beef + Veal	Ground	160°F (70°C)
	Steaks, Roasts: medium	160°F (70°C)
	Steaks, Roasts: rare	145°F (63°C)
Chicken + Turkey	Breasts	165°F (75°C)
	Ground, Stuffed	165°F (75°C)
	Whole bird, legs, thighs, wings	165°F (75°C)
Fish + Shellfish	Any type	145°F (63°C)
Lamb	Ground	160°F (70°C)
	Steaks, Roasts: medium	160°F (70°C)
	Steaks, Roast: rare	145°F (63°C)
Pork	Chops, Ground, Ribs, Roasts	160°F (70°C)
	Fully cooked Ham	140°F (60°C)

NOTES:

- Please keep in mind that because ingredients differ in size, shape, brand, and origin, we cannot guarantee that this is the best setting for the ingredients you have.
- Rapid Air Technology reheats the air inside the fryer instantly. Therefore, removing the basket of the air fryer for a brief period of time will not interrupt the cooking process.

TIPS

- Small ingredients usually require shorter cooking times compared to larger ingredients.
- Shaking smaller ingredients midway through the cooking

process will ensure the ingredients cook more evenly and have a better end result.

- Adding a very little amount of oil to fresh potatoes will give it a crispier result.
- Do not prepare extremely oily or greasy ingredients in the air fryer.
- Snacks that can be prepared in a traditional oven can also be prepared in the air fryer.
- The recommended amount of fries to allow for a crispy result is 17.5 oz.
- Pre-made dough requires a shorter cooking time than home-made dough.
- When making cake, quiche or ingredients with batter, use a baking pan or oven dish in the fry basket.

CLEANING YOUR AIR FRYER

1. Clean the fryer after every use.
2. Unplug the fryer. **ALWAYS WAIT UNTIL THE FRYER HAS COOLED TO A SAFE TEMPERATURE BEFORE HANDLING.**
3. Wipe the outside of the fryer with a damp cloth.
4. Wash the basket and crisper tray with hot water, soap and a non-abrasive sponge. You can remove any stuck-on food by using a degreasing liquid soap. For any hard-to-remove food, soak the basket and crisper tray in hot water.
5. Clean the inside of the appliance with a lightly dampened, non-abrasive sponge or cloth. Be careful not to get the inside of the appliance too wet and never submerge in water.
6. Scrub the heating element with a cleaning brush to remove any food debris.

TROUBLESHOOTING

Problem	Possible Cause	Solution
The fryer is not turning on	The appliance is not plugged in	Plug the appliance into a grounded wall socket.
	You have not set the timer	Set the timer using the control display to the correct time on the appliance.
	The basket is not pushed into the unit	Push the basket into the unit (see pg. 10).
Food is not cooked	The basket has been overfilled with ingredients	Place smaller batches of ingredients in the basket. Smaller batches are fried more evenly.
	The set temperature is too low	Increase the temperature to the required setting (see pg. 10).
Food is cooked unevenly	Ingredient positioning or overflow	Ingredients that lay on top or across from each other (e.g. fries) need to be shaken midway through cooking.
Fried snacks are not crispy after frying	Some snacks are crispier when traditionally fried	Cook oven snacks or lightly brush some oil onto the snacks for a crispier result.
Basket does not slide into the fryer properly	Overfilled basket	Do not fill the basket beyond the MAX fill indicator line.
White smoke comes out of the fryer	It is normal for white smoke to appear when prepping greasy ingredients	When frying greasy ingredients, a large amount of oil will leak into the basket. The oil produces white smoke and the basket may heat up more than usual. This does not affect the appliance or end food result.
	The basket is still greasy	Clean the air fryer properly after each use.
Fresh fries are fried unevenly in the fryer	Potatoes are not fresh	Use fresh potatoes and place them in the freezer for 30 minutes before air frying to help them stay firm during frying.
	Potato sticks have not been rinsed properly prior to frying	Make sure to rinse the potato sticks properly to remove the starch prior to frying.
Fries are not crispy	Water in the fries or not enough oil	Potato sticks should be dry prior to adding oil.
		Add more oil for a crispier result.

If your GoWISE USA Air Fryer displays any error codes, please contact our Customer Care Team.

855-233-9199

support@gowiseusa.com

Live Chat at gowiseusa.com

M-F 8:30am - 4:00pm MST

WARRANTY

GoWISE USA warrants all products against defects in materials and workmanship for **one (1) year** effective from the date of purchase.

GoWISE USA will replace any products that are found to be defective due to manufacturer flaws based on eligibility. Refunds issued by GoWISE USA must be purchased directly from GoWISE USA and are only available to the original purchaser within the first 30 days. We do not issue refunds for items bought by third party retailers.

This warranty extends only to personal use and does not extend to products that have been used for commercial, rental or any other use this product was not intended for. There are no warranties other than the warranties expressly set forth with each product.

This warranty is non-transferrable. GoWISE USA is not responsible in any way for any damages, losses, or inconveniences caused by equipment failure by user negligence, abuse, or use noncompliant with the user manual or any additional safety, use, or warnings included in the product packaging and manual.

This warranty only covers purchases within the 48 contiguous states of United States of America. For purchases made outside the 48 contiguous states, such as AK, HI, PR, or Canada, we will replace the unit under the one-year warranty upon receipt of a proven defect by video or picture. However, the replacement will only ship to a freight forwarder or address within the 48 contiguous United States. The consumer is responsible for arranging shipment outside of the 48 contiguous states.

GoWISE USA assumes no liability for damage caused using this product other than for its intended use or as instructed in the user manual. Some states do not allow this exclusion or limitation of incidental or consequential losses, so the foregoing disclaimer may not apply to you. This warranty gives you specific legal rights and you may also have other rights which may vary from state to state.

ALL EXPRESSED AND IMPLIED WARRANTIES INCLUDING THE WARRANTY OF MERCHANTABILITY, ARE LIMITED TO THE PERIOD OF THE LIMITED WARRANTY.

NOTE: General Warranty excludes refurbished / auction items.

WARRANTY

Additional 60-Days Warranty

You can extend your 1-year warranty by an additional 60 days. Log onto [www.gowiseproducts.com/apps/ product-registration](http://www.gowiseproducts.com/apps/product-registration) and register your product within the first 14 days of your purchase for the extended warranty.

DEFECTIVE PRODUCTS & RETURNS

If your product is defective within the 1-year warranty period, please email our Customer Care Team at support@gowiseusa.com. To expedite your issue, please provide the 4 items below:

1. Copy of the invoice, order information, or gift receipt showing the date of purchase
2. Serial number, usually found on a sticker located on the bottom on back of the unit
3. Picture or video of the issue or defect that you are experiencing
4. Shipping address information

Authorized Retailers:

Amazon

GoWISE USA

WayFair

Houzz

Home Depot

etailz

MorningSave.com

Bed Bath & Beyond

Jet.com

Walmart.com

Macy's

NOTES

GoWISEUSA®

WWW.GOWISEUSA.COM

855-233-9199

support@gowiseusa.com

Live Chat at gowiseusa.com

M-F 8:30am - 4:00pm MST

- To ensure the correct use of this appliance, read these instructions carefully and thoroughly.
- Please keep this manual for future reference.
- Thank you for purchasing this GoWISE USA Electric Air Fryer.

USE PROMO CODE: **LIVewiseraF**

**10%
OFF**

YOUR NEXT **GoWISEUSA®** PURCHASE

