

OWNER'S MANUAL

WASHING MACHINE

Please read this owner's manual thoroughly before operating and keep it handy for reference at all times.

WM3499H*A



MFL70561489

www.lg.com

Copyright © 2018 LG Electronics Inc. All Rights Reserved.

TABLE OF CONTENTS

3 PRODUCT FEATURES

4 IMPORTANT SAFETY INSTRUCTIONS

- 4 BASIC SAFETY PRECAUTIONS
- 5 GROUNDING INSTRUCTIONS
- 6 SAFETY INSTRUCTIONS FOR INSTALLATION
- 7 SAFETY INSTRUCTIONS FOR USE, CARE, CLEANING, AND DISPOSAL

8 PRODUCT OVERVIEW

- 8 Parts
- 8 Accessories
- 9 Control Panel Features

11 INSTALLATION

- 11 Installation Overview
- 12 Choosing the Proper Location
- 13 Unpacking and Removing Shipping Bolts
- 14 Connecting the Water Lines
- 15 Connecting the Drain Line
- 16 Leveling the Washer
- 17 Connecting to the Power Supply
- 17 Testing the Washer

18 PREPARATION

- 18 Sorting Wash Loads
- 19 - Fabric Care Labels
- 19 - Sorting Laundry
- 20 Using Detergent/Fabric Softener
- 20 - Recommended Detergent
- 20 - Loading the Dispenser

22 OPERATION

- 22 Using the Washer
- 23 Cycle Guide
- 24 Wash Cycles
- 24 - **Sanitary:** Reducing Laundry Bacteria
- 24 - **Baby Wear:** Lightly Soiled Baby Clothes
- 24 - **Bulky/Large:** Blankets or Bulky Items
- 24 - **Heavy Duty:** Heavily Soiled Items
- 24 - **Perm. Press:** Wrinkle-Free Items
- 24 - **Normal:** Normal Items
- 24 - **Allergiene™:** Help Prevent Allergens
- 24 - **Hand Wash/Wool:** Items Labeled Wool or Hand-Wash
- 24 - **Delicates:** Sheer Items
- 24 - **Quick Wash:** Washing Quickly

- 24 - **Wash+Dry:** A Small Load which Can Be Tumble Dried
- 24 - **Drain+Spin:** Drain and Spin Only
- 25 Cycle Modifier Buttons
- 25 Setting Options Before Cycle
- 25 - **Temp.**
- 25 - **Spin**
- 26 - **Dry**
- 27 - **Delay Wash**
- 27 - **Steam**
- 27 - **Wi-Fi**
- 27 - **Pre-wash**
- 27 - **Signal On/Off**
- 28 **Setting Options During Cycle**
- 28 - **Control Lock**
- 28 - **EcoHybrid**
- 28 - **Heavy Soil**
- 28 Add Garments

29 MAINTENANCE

- 29 Regular Cleaning
- 29 - Care After Wash
- 29 - Care in Cold Climates
- 30 Cleaning
- 30 - **Tub Clean**
- 31 - Cleaning the Detergent Dispenser Drawer
- 32 - Cleaning the Water Inlet Filters
- 33 - Cleaning the Drain Pump Filter
- 34 - Cleaning the Door Seal

35 TROUBLESHOOTING

- 35 Checking Error Messages
- 36 Before Calling for Service

39 SPECIFICATIONS

40 SMART FUNCTIONS

- 40 Using Smart Diagnosis™
- 40 Using LG SmartThinQ Application

43 WARRANTY

PRODUCT FEATURES

INVERTER DIRECT-DRIVE MOTOR

The inverter direct drive motor, which is directly connected to the drum, is capable of producing multiple distinct motions for optimal wash performance with very little noise and vibration. The motor assembly also contains fewer moving parts, resulting in fewer repairs.

SMART DIAGNOSIS™

Should you experience any technical difficulty with your washing machine, it has the capability of transmitting diagnostic data to your smart phone via a free app or directly to the Customer Information Center for quick and efficient troubleshooting (refer to page 40).

TUB CLEAN

Regular cleaning of the tub on a monthly basis using TUB CLEAN can help keep the tub clean and fresh.

LARGE CAPACITY STAINLESS STEEL DRUM

The large capacity stainless steel drum offers extreme durability and is tilted to improve efficiency and allow easier access for large items.

CONTROL LOCK

Use this option to disable the controls during a wash cycle. This option can prevent children from changing cycles or operating the machine.

DETERGENT DISPENSER DRAWER

The four-compartment dispenser drawer makes it easy to separate the pre-wash detergent, the main laundry detergent, liquid bleach, and fabric softener into different compartments that will be dispensed automatically at the appropriate time.

IMPORTANT SAFETY INSTRUCTIONS

READ ALL INSTRUCTIONS BEFORE USE

⚠ WARNING

For your safety, the information in this manual must be followed to minimize the risk of fire, explosion, or electric shock, or to prevent property damage, injury to persons, or death.

Your safety and the safety of others are very important.

We have provided many important safety messages in this manual and on your appliance. Always read and obey all safety messages.

⚠ This is the safety alert symbol.

This symbol alerts you to potential hazards that can kill or hurt you and others.

All safety messages will follow the safety alert symbol and either the word DANGER, WARNING or CAUTION. These words mean:

⚠ DANGER

You will be killed or seriously injured if you don't immediately follow instructions.

⚠ WARNING

You can be killed or seriously injured if you don't follow instructions.

⚠ CAUTION

You may be slightly injured or cause damage to the product if you do not follow instructions.

All safety messages will tell you what the potential hazard is, tell you how to reduce the chance of injury, and tell you what can happen if the instructions are not followed.

BASIC SAFETY PRECAUTIONS

⚠ WARNING

To reduce the risk of fire, electric shock, or injury to persons when using this appliance, follow basic precautions, including the following :

- Use this appliance only for its intended purpose as described in this owner's manual.
- Before use, the washer must be properly installed as described in this manual.
- Do not wash articles that have been previously cleaned in, washed in, soaked in, or spotted with gasoline, dry cleaning solvents, or other flammable or explosive substances, as they give off vapors that could ignite or explode.
- Do not add gasoline, dry cleaning solvents, or other flammable or explosive substances to the wash water. These substances give off vapors that could ignite or explode.
- Under certain conditions, hydrogen gas may be produced in a hot water system that has not been used for 2 weeks or more. HYDROGEN GAS IS EXPLOSIVE. If the hot water system has not been used for such a period, before using the washer, turn on all hot water faucets and let the water flow from each for several minutes. This will release any accumulated hydrogen gas. As the gas is flammable, do not smoke or use an open flame during this time.
- Do not allow children to play on or in the washer. Close supervision of children is necessary when the washer is used near children.
- Before the washer is removed from service or discarded, remove the lid to prevent children from climbing inside.
- Do not install or store the washer where it will be exposed to the weather or freezing temperatures.
- Do not tamper with controls.
- Keep the area underneath and around your appliances free of combustible materials (lint, paper, rags, etc.), gasoline, chemicals and other flammable vapors and liquids.
- Do not repair or replace any part of the washer or attempt any servicing other than as described in this manual. We strongly recommend that any service be performed by a qualified technician.
- See Installation Instructions for grounding requirements.
- ALWAYS follow the fabric care instructions supplied by the garment manufacturer.
- Do not place items exposed to cooking oil in your washer. Items contaminated with cooking oils may contribute to a chemical reaction that could cause a load to catch fire.
- Use fabric softeners or products to eliminate static only as recommended by the manufacturer.
- This washer is not designed for maritime use or for mobile installations such as in RVs, aircraft, etc.
- Turn off the water faucets and unplug the washer if the machine is to be left for an extended period of time, such as during vacations.
- Packaging material can be dangerous for children. There is a risk of suffocation! Keep all packaging from children.
- Always check the inside of the washer for foreign objects before loading laundry. Keep the lid closed when not in use.
- Do not reach into the appliance if the tub or agitator is moving.

⚠ WARNING

For your safety, the information in this manual must be followed to minimize the risk of fire, explosion, or electric shock, or to prevent property damage, injury to persons, or death.

GROUNDING INSTRUCTIONS

This appliance must be grounded. In the event of malfunction or breakdown, grounding will reduce the risk of electric shock by providing a path of least resistance for electric current. This appliance is equipped with a cord having an equipment-grounding conductor and grounding plug. The plug must be plugged into an appropriate outlet that is properly installed and grounded in accordance with all local codes and ordinances.

⚠ WARNING

Improper connection of the equipment-grounding conductor can result in risk of electric shock. Check with a qualified electrician or servicer if you are in doubt as to whether the appliance is properly grounded. Do not modify the plug provided with the appliance. If it does not fit the outlet, have a proper outlet installed by a qualified electrician. Failure to follow these warnings can cause serious injury, fire, electric shock, or death.

⚠ WARNING

For your safety, the information in this manual must be followed to minimize the risk of fire, explosion, or electric shock, or to prevent property damage, injury to persons, or death.

SAFETY INSTRUCTIONS FOR INSTALLATION

⚠ WARNING

To reduce the risk of fire, electric shock, or injury to persons when using this appliance, follow basic precautions, including the following :

- Refer to the **INSTALLATION INSTRUCTIONS** for detailed grounding procedures. Installation instructions are packed with the washer for the installer's reference. If the washer is moved to a new location, have it checked and reinstalled by a qualified service technician. Failure to follow this warning can cause serious injury, fire, electric shock, or death.
- Do not, under any circumstances, cut or remove the third (ground) prong from the power cord. Failure to follow this warning can cause serious injury, fire, electric shock, or death.
- For personal safety, this appliance must be properly grounded. Failure to follow this warning can cause serious injury, fire, electric shock, or death.
- The power cord of this appliance is equipped with a 3-prong (grounding) plug which mates with a standard 3-prong (grounding) wall outlet to minimize the possibility of electric shock from this appliance.
- This washer must be plugged into a 120 VAC, 60 Hz grounded outlet. Failure to follow this warning can cause serious injury, fire, electric shock, or death.
- Have the wall outlet and circuit checked by a qualified electrician to make sure the outlet is properly grounded. Failure to follow this warning can cause serious injury, fire, electric shock, or death.
- Where a standard 2-prong wall outlet is encountered, it is your personal responsibility and obligation to have it replaced with a properly grounded 3-prong wall outlet. Failure to follow this warning can cause serious injury, fire, electric shock, or death.
- Do not install on carpet. Install washer on a solid floor. Failure to follow this warning can cause serious leak damage.
- Do not remove ground prong. Do not use an adapter or extension cord. Plug into a grounded 3-prong outlet. Failure to follow these warnings can cause serious injury, fire, electric shock, or death.
- The washer should always be plugged into its own individual electrical outlet which has a voltage rating that matches the rating plate. This provides the best performance and also prevents overloading house wiring circuits which could cause a fire hazard from overheated wires.
- **Never unplug your washer by pulling on the power cord.** Always grip the plug firmly and pull straight out from the outlet. Failure to follow this warning can cause serious injury, fire, electric shock, or death.
- **Repair or immediately replace all power cords that have become frayed or otherwise damaged.** Do not use a cord that shows cracks or abrasion damage along its length or at either end. Failure to follow this warning can cause serious injury, fire, electric shock, or death.
- **When installing or moving the washer, be careful not to pinch, crush, or damage the power cord.** Failure to follow this warning can cause serious injury, fire, electric shock, or death.
- **The washer must be installed and electrically grounded by a qualified service person in accordance with local codes to prevent shock hazard and assure stability during operation.**
- **The washer is heavy. Two or more people may be needed to install and move the appliance.** Failure to do so can result in back or other injury.
- **Store and install the washer where it will not be exposed to temperatures below freezing or exposed to outdoor weather conditions.** Failure to follow this warning can cause serious leak damage.
- **To reduce the risk of electric shock, do not install the washer in humid spaces.** Failure to follow this warning can cause serious injury, fire, electric shock, or death.
- **To reduce the risk of injury to persons, adhere to all industry recommended safety procedures including the use of long sleeved gloves and safety glasses.** Failure to follow all of the safety warnings in this manual could result in property damage, injury to persons or death.

⚠ WARNING

For your safety, the information in this manual must be followed to minimize the risk of fire, explosion, or electric shock, or to prevent property damage, injury to persons, or death.

SAFETY INSTRUCTIONS FOR USE, CARE, CLEANING, AND DISPOSAL

⚠ WARNING

To reduce the risk of fire, electric shock, or injury to persons when using this appliance, follow basic precautions, including the following :

- Unplug the washer before cleaning to avoid the risk of electric shock.
- Never use harsh chemicals, abrasive cleaners, or solvents to clean the washer. They will damage the finish.
- Do not put oily or greasy rags or clothing on top of the washer. These substances give off vapors that could ignite the materials.
- Do not wash items that are soiled with vegetable or cooking oil. These items may contain some oil after laundering. Due to the remaining oil, the fabric may smoke or catch fire by itself.
- Disconnect this appliance from the power supply before attempting any user maintenance. Turning the controls to the OFF position does not disconnect this appliance from the power supply. Failure to follow this warning can cause serious injury, fire, electric shock, or death.
- Do not combine laundry products for use in one load unless specified on the label.
- Do not mix chlorine bleach with ammonia or acids such as vinegar. Follow package directions when using laundry products. Incorrect usage can produce poisonous gas, resulting in serious injury or death.
- Do not reach into the washer while parts are moving. Before loading, unloading, or adding items, press the START/PAUSE button and allow the drum to coast to a complete stop before reaching inside. Failure to follow this warning can cause serious injury, fire, electric shock, or death.
- Do not allow children to play on or in the washer. Close supervision of children is necessary when the washer is used near children. As children grow, teach them the proper, safe use of all appliances. Failure to comply with these warnings could result in serious injury to persons or death.
- Destroy the carton, plastic bag, and other packing materials after the washer is unpacked. Children might use them for play. Cartons covered with rugs, bedspreads, or plastic sheets can become airtight chambers. Failure to comply with these warnings could result in serious injury to persons or death.
- Keep laundry products out of children's reach. To prevent injury to persons, observe all warnings on product labels. Failure to comply with these warnings could result in serious injury to persons or death..
- Before your washer is removed from service or discarded, remove the door to the washing compartment to avoid the danger of children or small animals getting trapped inside. Failure to do so can result in serious injury to persons or death.
- Make sure the dispenser drawer is closed at all times when not being filled with laundry products. Failure to keep the drawer closed can result in personal injury or flooding.
- Certain internal parts are intentionally not grounded and may present a risk of electric shock only during servicing. Service personnel - Do not contact the following parts while the appliance is energized: pump, valve, motor, control board, drying heater.

SAVE THESE INSTRUCTIONS

PRODUCT OVERVIEW

Parts

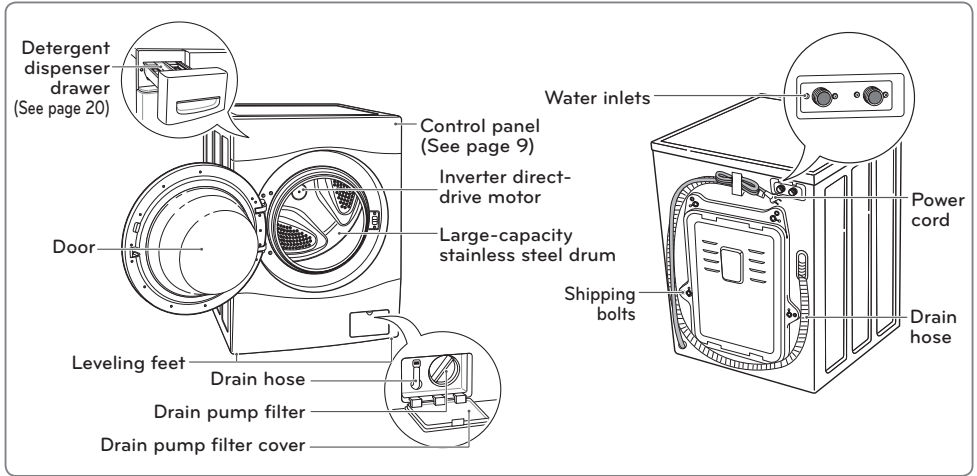

Accessories

Included Accessories



Hot/cold water hoses



Non-skid pads



Caps for covering shipping bolt holes



Wrench



Tie strap (optional)



Elbow bracket
(for securing drain hose)



NOTE

- Contact LG Customer Service at 1-800-243-0000 (1-888-542-2623 in Canada) if any accessories are missing.
- For your safety and for extended product life, use only authorized components. The manufacturer is not responsible for product malfunction or accidents caused by the use of separately purchased unauthorized components or parts.
- The images in this guide may be different from the actual components and accessories, which are subject to change by the manufacturer without prior notice for product improvement purposes.

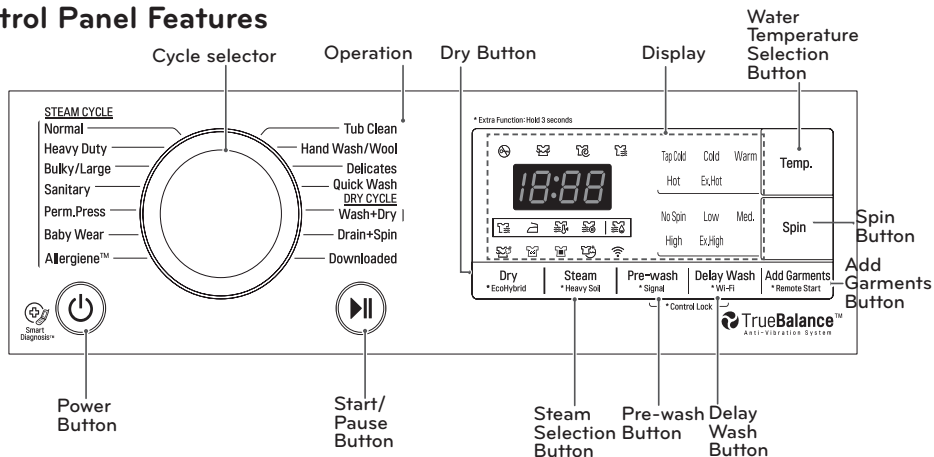
Control Panel Features

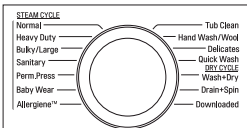

Operation

Button	Description
	<ul style="list-style-type: none"> • Turns the washing machine on and off. • (During the wash cycle) stops operation, and cancels the settings.
	<ul style="list-style-type: none"> • Tub Clean - For tub clean (see page 30). • Sanitary - For underwear, diapers, etc. (see page 24). • Baby Wear - For lightly soiled baby clothes (see page 24). • Bulky/Large - For blankets or large, bulky items (see page 24). • Heavy Duty - For heavily soiled cotton fabric (see page 24). • Perm. Press - For wrinkle-free fabric (see page 24). • Normal - For general laundry, such as cotton T-shirts or towels (see page 24). • Quick Wash - Provides fast washing time for small loads and lightly soiled clothes. (see page 24). • Hand Wash/Wool - For wool or hand-wash fabrics (see page 24). • Delicates - For sheer and delicate fabrics (see page 24). • Allergiene™ - For cotton, underwear, pillow covers, bed sheets, baby wear (see page 24). • Wash+Dry - For a small load which can be washed and dried in the same cycle (see page 24). • Drain+Spin - For items that only require draining and spinning (see page 24).
	<ul style="list-style-type: none"> • Starts or pauses the wash cycle. - If you do not press the Start/Pause button within 4 minutes of selecting a cycle, the washing machine will turn off automatically and all settings will be lost.
<div style="border: 1px solid black; padding: 2px; display: inline-block;">Temp.</div>	<ul style="list-style-type: none"> • (Press repeatedly) Selects the water temperature for the wash cycle (see page 25). - Select water temperature from 5 settings.
<div style="border: 1px solid black; padding: 2px; display: inline-block;">Spin</div>	<ul style="list-style-type: none"> • (Press repeatedly) Selects the spin speed (see page 25). - Selects spin speed from 5 settings.
<div style="border: 1px solid black; padding: 2px; display: inline-block;">Dry <small>* EcoHydri</small></div>	<ul style="list-style-type: none"> • (Press repeatedly) Selects a dry cycle. Pressing this button enables drying. (See page 26).

Operation (continued)

Button	Description
Delay Wash <small>* Wi-Fi</small>	<ul style="list-style-type: none"> Set the delay time of starting the cycle (see page 27).
Steam <small>* Heavy Soil</small>	<ul style="list-style-type: none"> Use this option for enhanced washing performance with low energy consumption.
Add Garments <small>* Remote Start</small>	<ul style="list-style-type: none"> Use this option to add garments or remove foreign objects like coins or keys after the cycle has started (see page 28).
Pre-wash <small>* Smart</small>	<ul style="list-style-type: none"> (Press before wash cycle) Pre-wash heavily soiled laundry (see page 27). (Press and hold during wash cycle) Lock/Unlock the buttons (see page 28).

Display

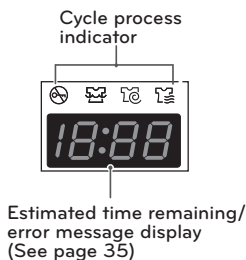

Display Icon	Description
	<ul style="list-style-type: none"> This portion of the display shows which stage of the wash cycle is currently under way (Wash, Spin, Dry).
	<ul style="list-style-type: none"> This indicator shows that the door is locked. The washer door will lock while the washer is operating. The door can be unlocked by pressing the Start/ Pause button to stop the washer.
	<ul style="list-style-type: none"> When the Start/Pause button is pressed, the washer automatically detects the wash load (weight) and optimizes the washing time, based on the selected cycle and options. The display will then indicate the estimated time remaining for the selected wash cycle.

INSTALLATION

Installation Overview

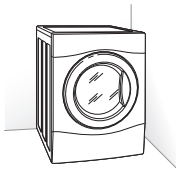

Choosing the proper location

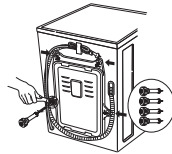

Unpacking and removing shipping bolts

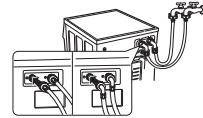

Connecting the water line

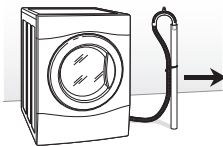

Connecting the drain line

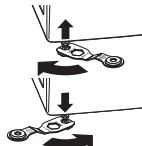

Leveling the washer

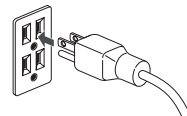

Connecting to the power supply



Testing the washer

⚠ WARNING

- Washer is heavy! Two or more people are required when moving and unpacking the washer. Failure to follow this warning can result in back or other injury.
- Store and install the washer where it will not be exposed to temperatures below freezing or exposed to outdoor weather conditions. Failure to follow this warning can cause serious injury, fire, electric shock, or death.
- Properly ground washer to conform with all governing codes and ordinances. Failure to follow this warning can cause serious injury, fire, electric shock, or death.
- To reduce the risk of electric shock, do not install the washer in humid spaces. Failure to follow this warning can cause serious injury, fire, electric shock, or death.
- The base opening must not be obstructed by carpeting when the washer is installed on a carpeted floor.
- Do not remove ground prong. Do not use an adapter or extension cord. Plug into a grounded 3-prong outlet. Failure to follow this warning can cause serious injury, fire, electric shock, or death.
- Certain internal parts are intentionally not grounded and may present a risk of electric shock only during servicing. Service personnel - Do not contact the following parts while the appliance is energized: pump, valve, motor, control board.

Choosing the Proper Location

Install the washing machine on a solid floor that is strong and rigid enough to support the weight of the washing machine, even when fully loaded, without flexing or bouncing. If the floor has too much flex, you may need to reinforce it to make it more rigid. If the floor is not solid, it may cause severe vibration and noise.

- 1 Clean the floor before installation.
 - Make sure to select solid and smooth ground.
- 2 Two or more people are needed for moving and unpacking the washing machine.
- 3 Allow for sufficient space between the walls and the washing machine for installation.

Space Requirements

You must allow sufficient space for water lines, the drain line, and airflow.

! NOTE

- Be sure to allow for wall, door, or floor moldings that may increase the required clearances.

! NOTE

- The floor must be strong and rigid enough to support the weight of the washer, when fully loaded, without flexing or bouncing. If your floor has too much flex, you may need to reinforce it to make it more rigid. A floor that is adequate for a top-loading washer may not be rigid enough for a front loading washer, due to the difference in the spin speed and direction. If the floor is not solid, your washer may vibrate and you may hear and feel the vibration throughout your house.
- Before installing the washer, make sure the floor is clean, dry and free of dust, dirt, water and oils so the washer feet can not slide easily. Leveling feet that can move or slide on the floor can contribute to excess vibration and noise due to poor contact with the floor.
- If a drip pan must be used, take extra care to follow the instructions provided with the drip pan and make sure the leveling feet are adjusted for firm and even contact with the pan. Use of drip pans and failure to properly level the machine may result in increased vibration and noise during operation.

Clearances

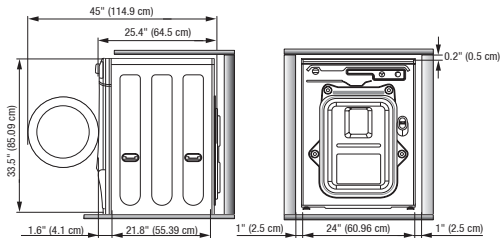

Unpacking and Removing Shipping Bolts

Remove the washer from the carton base.

If you must lay the washer down to remove the base packaging materials, always lay it carefully on its side. Do not lay the washer on its front or back.

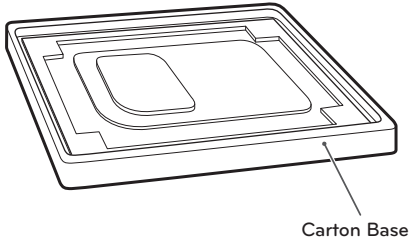

- 1 Starting with the bottom two shipping bolts, use the wrench (included) to fully loosen all four shipping bolts by turning them counterclockwise. Remove the bolt assemblies by wiggling them slightly while pulling them out.

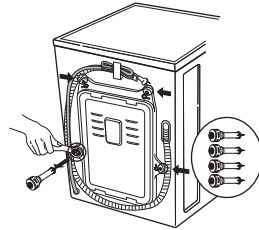

- 2 Locate the four hole caps included in the accessory pack and install them in the shipping bolt holes.

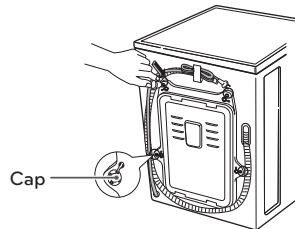

! NOTE

- Save the bolt assemblies for future use. To prevent damage to internal components, do not transport the washer without reinstalling the shipping bolts.
- Failure to remove shipping bolts and retainers may cause severe vibration and noise, which can lead to permanent damage to the washer. The cord is secured to the back of the washer with a shipping bolt to help prevent operation with shipping bolts in place.

Connecting the Water Lines

- 1 Check the rubber seals on both sides of the hose.
 - Insert a rubber seal into the threaded fittings on each hose to prevent leaking.

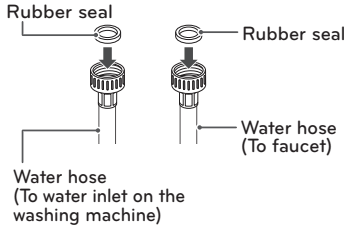

- 2 Connect the water supply hoses to the HOT and COLD water faucets tightly by hand and then tighten another 2/3 turn with pliers.
 - Connect the blue hose to a cold water faucet and the red hose to a hot water faucet.

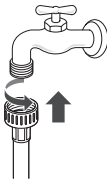

⚠ WARNING

- Do not overtighten. Damage to the coupling can result.

- 3 After connecting the inlet hoses to the water faucets, turn on the water faucets to flush out foreign substances (dirt, sand or sawdust) in the water lines. Let the water drain into a bucket, and check the water temperature.

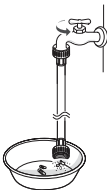

- 4 Connect the hoses to the water inlets tightly by hand and then tighten another 2/3 turn with pliers.
 - Connect the blue hose to the cold water inlet and the red hose to the hot water inlet.

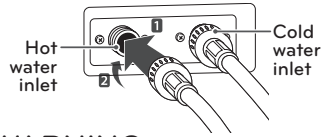

⚠ WARNING

- Do not overtighten the hoses. Overtightening can damage the valves resulting in leaking and property damage.

- 5 Check for leaks by turning on the faucets.
 - If water leaks, check steps 1 to 4 again.

ⓘ NOTE

- For your safety, and for extended product life, use only authorized components. The manufacturer is not responsible for product malfunction or accidents caused by the use of separately purchased, unauthorized parts.
- Use new hoses when installing the washing machine. Do not reuse old hoses.
- Contact LG Customer Service for Assistance in buying hoses : 1-800-243-0000.
- Periodically check the hoses for cracks, leaks and wear, and replace the hoses every 5 years. Do not stretch the water hoses intentionally, and make sure that they are not crushed by other objects.
- Water supply pressure must be between 20 psi and 120 psi (138 – 827 kPA). If the Water supply pressure is more than 120 psi, a pressure reducing valve must be installed.
- To provide optimum washing performance the hot water temperature should be set at 120 – 135°F (48-57°C) and the cold at 60°F (15°C).

Connecting the Drain Line

Secure the drain hose in place to prevent moving and leaking.

NOTE

- The drain hose should be properly secured. Failure to properly secure the drain hose can result in flooding and malfunction.
- Total height of the hose end should not exceed 96 inches (244.8 cm) from the bottom of the washer.
- The drain must be installed in accordance with any applicable local codes and regulations.
- Make sure that the water lines are not stretched, pinched, crushed, or kinked.

Using a Laundry Tub

- 1 Clip the end of the hose into the elbow bracket.
 - Connect the elbow bracket within 4 inches (10 cm) of the end of the drain hose. If the drain hose is extended more than 4 inches (10 cm) beyond the end of the elbow bracket, mold or microorganisms could spread to the inside of the washer.

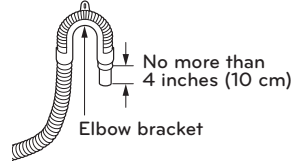

- 2 Hang the end of the drain hose over the side of the laundry tub.

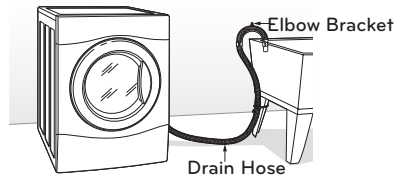

Using a Standpipe

- 1 Clip the end of the hose into the elbow bracket.
 - Connect the elbow bracket within 4 inches (10 cm) of the end of the drain hose. If the drain hose is extended more than 4 inches (10 cm) beyond the end of the elbow bracket, mold or microorganisms could spread to the inside of the washer.

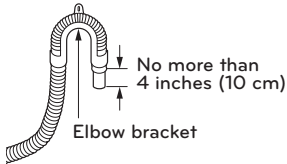

- 2 Insert the end of the drain hose into the standpipe.

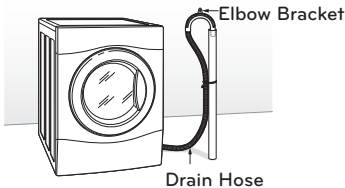

- 3 Use a tie strap to secure the drain hose in place.

Leveling the Washer

The drum of your new washing machine spins at very high speeds. To minimize vibration, noise, and unwanted movement, the floor must be perfectly level and solid.

- 1 Check that the washing machine is level.
 - Ensure it is level by rocking the top edges of the washing machine or placing a level on the washing machine. The slope beneath the washing machine must not exceed 1°, and all four leveling feet must rest firmly on the floor.

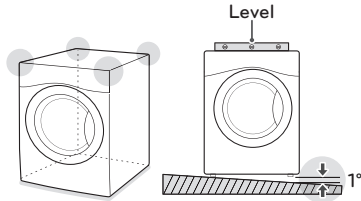

- 2 Turn the lower leveling feet clockwise to level the washing machine.
 - Turning the lower leveling feet clockwise raises the washing machine.

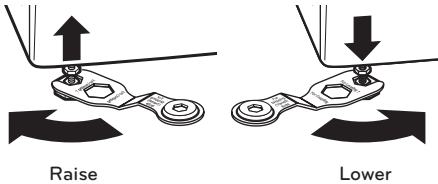

- 3 Turn the locknuts counterclockwise and tighten them when the washing machine is level.

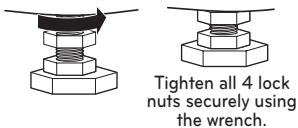

- 4 Check again to make sure the machine is level.
 - Push or rock the top edges of the washing machine gently to make sure that the washing machine does not rock.
 - If the washing machine rocks, repeat steps 1 to 3.

⚠ WARNING

- Using the washing machine without leveling, it may result in malfunction caused by the production of excess vibration and noise.
- If you are installing the washing machine on the optional pedestal, you must adjust the leveling feet on the pedestal to level the washing machine. The washing machine's leveling feet should be minimized and the locknuts turned counterclockwise to secure them.
- Use the leveling feet only when you level the washing machine. If you raise the leveling feet unnecessarily, it may cause abnormal vibration of the washing machine.

Using Non-Skid Pads (Optional)

If you install the washing machine on a slippery surface, it may move because of excessive vibration. Incorrect leveling may cause malfunction through noise and vibration. If this occurs, lay the non-skid pads under the leveling feet and adjust the level.

- 1 Clean the floor to attach the non-skid pads.
 - Use a dry rag to remove and clean foreign objects or moisture. If moisture remains, the non-skid pads may slip.
- 2 Adjust the level after placing the washing machine in the installation area.
- 3 Place the adhesive side of the non-skid pad on the floor.
 - It is most effective to install the non-skid pads under the front legs. If it is hard to place the pads under the front legs, place them under the back legs.

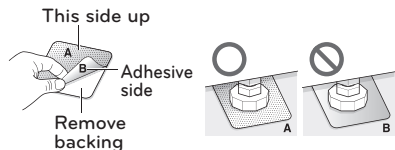

- 4 Check the washing machine's level again.
 - Push or rock the top edges of the washing machine gently to make sure that the washing machine does not rock. If the washing machine rocks, level the washing machine again.

Connecting to the Power Supply

Make sure to ground the washing machine to prevent a short circuit or an electric shock when plugging in.

Using a 3-Prong Outlet

If plugged into a grounded, 3-prong outlet rated for use with this appliance, no further grounding is necessary.

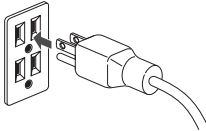

⚠ WARNING

- The power outlet must be within 60 inches (1.5 m) of either side of the washer.
- The appliance and outlet must be positioned so that the plug is easily accessible.
- Do not overload the outlet with more than one appliance.
- The outlet must be grounded in accordance with current wiring codes and regulations.
- Time-delay fuse or circuit breaker is recommended.
- It is the personal responsibility and obligation of the product owner to have a proper outlet installed by a qualified electrician.
- Do not use a worn or damaged power cord or power plug. Replace or repair worn or damages cords or plugs it immediately. Failure to do so may result in death, fire, electric shock, or malfunction.
- Do not modify the power cord and take care not to damage it when installing or moving the washing machine. Failure to follow this warning may result in death, fire, electric shock, or malfunction.
- Make sure that the washing machine is grounded.
- Connect this washing machine to a grounded outlet conforming to the rating prior to use. Failure to do so may result in fire, electric shock, or malfunction.
- Do not use adaptors or extension cords. The washing machine should always be plugged into its own individual electrical outlet which has a voltage rating that matches the rating plate. Failure to do so may result in fire, electric shock or malfunction.
- Do not damage or cut off the ground prong of the power cord. Doing so may cause death, fire, electric shock, or product malfunction.

Testing the Washer

Check if the washing machine is properly installed and run a test cycle.

- 1 Load the washing machine with 6 pounds of laundry (approximately 14 shirts).
- 2 Press the Power button and turn the cycle selector knob to the right.
- 3 Press the Rinse+Spin button to select Rinse+Spin.
- 4 Press the Start/Pause button.
 - The wash cycle starts.
- 5 Check if water is supplied, that the washing machine does not rock or vibrate excessively, and that it drains well during the spin cycle.
 - If water leaks during water supply, see page 14, Connecting the water lines, to connect them properly.
 - If the washing machine rocks and vibrates excessively, see page 16, Leveling the washing machine, to level it again.
 - If the drain does not work, see page 15, Connecting the drain line, to install it properly.

PREPARATION

Sorting Wash Loads

Read and observe the following to prevent shrinkage or damage to clothes.



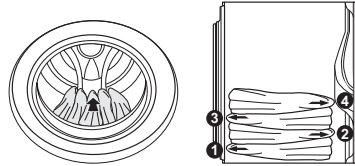







- ◆ Check all pockets to make sure that they are empty.
 - Items such as clips, matches, pens, coins, and keys can damage both your washer and your clothes.
- ◆ Close zippers, hooks, and drawstrings to prevent these items from snagging or tangling on other clothes.
- ◆ Pretreat heavily stained areas before washing.
 - Doing so will produce clean, stain-free results.
- ◆ Combine large and small items in a load. Load large items first.
- ◆ Large items should not be more than half of the total washload.
- ◆ The washer can be fully loaded, but the drum should not be tightly packed with items.
 - The door of the washer should close easily.
- ◆ Do not wash single items, except for bulky items such as blankets. Make sure to wash laundry in similar types of loads.
 - Washing a single small item may result in the tub becoming unbalanced, vibrating and making a noise.
- ◆ Do not wash waterproof clothes.
 - This may cause abnormal vibration, or may cause the load to bounce, which could damage the tub.
- ◆ Check if there are any foreign objects in the door seal and take extra care that clothes do not get caught there.
 - Foreign objects in the door seal may stain clothes, and water may leak if clothes get caught in the door seal.
- ◆ Wash underwear or small, light items in a laundry net (mesh bag).
 - Small, light items may get caught in the door seal, and a brassiere hook may damage other items or the tub.
- ◆ Brush heavy soil, dust, or hair off fabrics before washing.
 - Laundry may not wash clean if there is dirt or sand on the fabrics, or items may be damaged due to particles rubbing against sheer fabrics.
- ◆ Wash blankets individually.
 - Washing more than one blanket in a load may produce inferior results due to tangling or an unbalanced load.
- ◆ Always separate fabrics according to their colors and wash them separately to prevent colors from running.
 - Fabrics may be damaged or become stained due to fabric dyes running, or due to foreign objects transferring from one fabric to another.
- ◆ For best performance, load clothes as shown.



- Load clothes loosely, and do not overfill the drum. Clothes need room to circulate in order to get clean.
- Do not press down on items while stacking them in the drum.

Fabric Care Labels

Most articles of clothing feature fabric care labels that include instructions for proper care.

Category	Label	Directions
 Washing		Hand Wash
		Machine Wash, Normal Cycle
		Use Permanent Press/ Wrinkle Resistant washing machine setting (which has a cool down or cold spray before the reduced spin)
		Use Gentle/Delicates washing machine setting (slow agitation and/ reduced wash time).
		Do Not Wash
		Do Not Wring
Water Temperature	...	Hot
	..	Warm
	.	Cold/Cool
 Bleach symbols		Any Bleach (When Needed)
		Only Non-Chlorine Bleach (When Needed)
		Do Not Bleach

Sorting Laundry

Sort laundry into similar loads that are washable in the same cycle.

Refer to the following chart for sorting clothes.

Colors	Whites / Lights / Darks
Soil	Heavy / Normal / Light
Fabric	Delicates / Easy Care / Sturdy Cottons
Lint	Lint Producers / Lint Collectors

Using Detergent/Fabric Softener

Recommended Detergent

Make sure to use HE (High-Efficiency) detergent for front-loading washing machines. HE detergents dissolve more efficiently and produce fewer suds to ensure efficient washing and rinsing. Use the correct amount of detergent as indicated on the detergent packaging.



Specially designed to use only HE (High-Efficiency) detergent

NOTE

- Only use HE detergents, because using a regular detergent may produce excessive suds.
- HE detergents produce fewer suds, dissolve more efficiently to improve washing and rinsing performance, and help to keep the interior of your washer clean.
- Use less detergent for soft water.
- Wipe up any spills immediately, as liquids could damage the finish and the control panel of the washing machine.
- Using too much detergent can cause a build-up in the tub resulting in unsatisfactory performance and machine malfunction.
- If you use a detergent that does not dissolve easily or a detergent with high viscosity, it will leave a residue on the tub, which may not rinse properly.

Loading the Dispenser

The detergent dispenser drawer of the washing machine has a dispenser compartment for each detergent type. Add each detergent to its appropriate compartment.

- 1 Pull out the detergent dispenser drawer.
- 2 Add each detergent to its appropriate compartment.

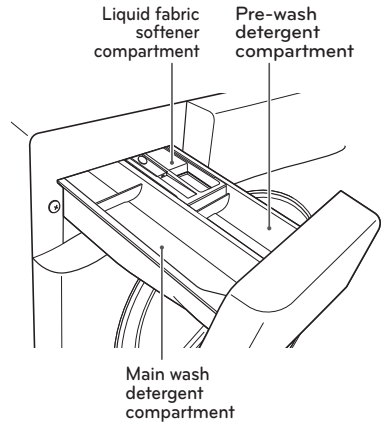

- 3 Close the detergent dispenser drawer slowly.
 - Slamming the detergent dispenser drawer may result in the detergent overflowing into another compartment or pouring into the tub earlier than programmed.

NOTE

- It is normal for a small amount of water to remain in the dispenser compartments at the end of the cycle.

Pre-wash Detergent Compartment

Add liquid or powdered detergent to this compartment when using the Pre-Wash option. Always use HE (High-Efficiency) detergent with your washing machine.

! NOTE

- The amount of detergent added for the Pre-wash option is 1/2 the amount recommended for the main wash cycle. For example, if the main wash cycle requires one measure of detergent, add 1/2 measure for the Pre-Wash option.

Main Wash Detergent Compartment

This compartment holds laundry detergent for the main wash cycle, which is added to the load at the beginning of the cycle. Always use HE (High-Efficiency) detergent with your washing machine.

Never exceed the manufacturer's recommendations when adding detergent. Using too much detergent can result in detergent buildup on clothing and the washer. Either powdered or liquid detergent may be used.

! NOTE

- Liquid or powdered color-safe bleach may be added to the main wash compartment with detergent of the same type.

Fabric Softener Compartment







This compartment holds liquid fabric softener, which will be automatically dispensed during the final rinse cycle.

! NOTE

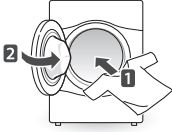
- Always follow the manufacturer's recommendations when adding fabric softener. Do not exceed the maximum fill line. Using too much fabric softener may result in stained clothes.
- Dilute concentrated fabric softeners with warm water. Do not exceed the maximum fill line.
- Never pour fabric softener directly onto the load or into the drum.

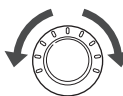
OPERATION

Using the Washer

- 1  Load the laundry into the washing machine and close the door.
- 2  Press the Power button.
 - The lights around the cycle selector knob will illuminate and a chime will sound.
- 3  Turn the cycle selector knob in either direction to select the desired cycle.
 - The proper default option is automatically set according to the wash cycle. See page 23, Cycle Guide, for more detailed default options for each cycle.
 - See page 24, Wash Cycles, for details on the wash cycles.
 - To change the options, press the option button and select the desired option. See page 25, Setting Options Before Cycle, for more details on options.
 - Skip to step 4 to use the default setting without changing the options.
- 4  Add the proper amount of detergent and additions (bleach, softener) into the detergent dispenser drawer.
 - See page 20, Using Detergent/Fabric Softener, for more details on using detergent.
- 5  Press the Start/Pause button.
 - The washing machine will start.
- 6  When the melody plays, the wash cycle is finished.
 - When the washing cycle is finished, the door will unlock. Open the door and remove the laundry immediately.
 - Make sure to check around the door seal when taking out the finished load. Small items may be caught in the door seal.

⚠ WARNING

- To reduce the risk of fire, electric shock, or injury to persons, read the IMPORTANT SAFETY INSTRUCTIONS before operating this appliance.

ⓘ NOTE

- The front-load washing machine rotates the laundry in a way that allows it to use less water while still fully saturating your clothing. It is normal to not be able to see water during the wash cycle.
- If the temperature or the water level inside the machine is too high, the door locks and cannot be opened.
- If drying items, make sure the drum is no more than half full before beginning the dry cycle.

Cycle Guide

The cycle guide below shows the options and recommended fabric types for each cycle. ● = Available option

CYCLE	FABRIC TYPE	BASIC OPTION (*=DEFAULT)			ADDITIONAL OPTIONS				
		Soil Level	Temp.	Spin	Dry	Steam	Pre Wash	Delay Wash	Add Garments
Allergiene™	Cotton, underwear, pillow covers, bed sheets, baby wear	Heavy Normal*	Ex.Hot*	Ex.High* High Med. Low No Spin	●	●*		●	●
Baby Wear	Lightly soiled baby clothes	Heavy Normal*	Hot* Warm	High* Med. Low No Spin	●		●**	●	●
Perm. Press	Dress shirts/pants, wrinkle free clothing, poly/cotton blend clothing, tablecloths	Heavy Normal*	Warm* Cold Tap Cold	Ex.High* High Med. Low No Spin	●	●	●	●	●
Sanitary	Heavily soiled underwear, work clothes, diapers, etc.	Heavy Normal*	Ex.Hot*	Ex.High* High Med. Low No Spin	●	●	●	●	●
Bulky/ Large	Large items such as blankets and comforters	Heavy Normal*	Warm* Cold Tap Cold	High Med.* Low No Spin		●		●	●
Heavy Duty	Heavily soiled cotton fabrics	Heavy Normal*	Hot Warm*	Ex.High High Med.* Low No Spin	●	●	●	●	●
Normal	Cotton, linen, towels, shirts, sheets, jeans, mixed loads	Heavy Normal*	Hot Warm* Cold Tap Cold	Ex.High High* Med. Low No Spin	●	●	●	●	●
Tub Clean	Removes residue and odors from washer drum								
Hand Wash/ Wool	Items labeled "hand washable"	Heavy Normal*	Warm Cold Tap Cold*	Med.* Low No Spin				●	●
Delicates	Dress shirts/blouses nylons, sheer or lacy garments	Heavy Normal*	Warm Cold* Tap Cold	Med.* Low No Spin	●			●	●
Quick Wash	Lightly soiled clothing and small loads	Heavy Normal*	Warm Cold* Tap Cold	Ex.High High Med.* Low No Spin	●		●	●	●
Wash+Dry	A small load which can be washed and dried in one cycle	Heavy Normal*	Hot Warm* Cold Tap Cold	Ex.High* High	●*	●	●	●	●
Drain+Spin	Drain and spin only			Ex.High* High Med. Low No Spin				●	

- Cycle time depends on water pressure, type and amount of load, and chosen additional options.

- To protect your garments, not every wash/rinse temperature, spin speed, soil level, or option is available with every cycle.

* : This option is automatically included in the cycle and can not be deleted.

** : This option is automatically included in the cycle and can be deleted.

Wash Cycles

You can wash laundry items more thoroughly by selecting the wash cycle that best suits the type of items to be washed. Turn the cycle selector knob in either direction to select the desired cycle. When you select a wash cycle, the light for the corresponding wash cycle will turn on. See page 22, Using the Washer, for more details on operating methods.

Sanitary: Reducing Laundry Bacteria

This wash cycle helps to remove heavy soil on laundry through high temperature.

Baby Wear: Lightly Soiled Baby Clothes

This cycle helps remove food stains from baby clothes using a powerful rinse.

Bulky/Large: Blankets or Bulky Items

This cycle is for washing blankets or bulky items.

Heavy Duty: Heavily Soiled Items

This cycle is for washing heavily soiled laundry through more powerful drum rotation.

Perm. Press: Wrinkle-Free Items

This cycle is for washing items such as wrinkle-free clothes or tablecloths to minimize wrinkles.

Normal: Normal Items

Use this cycle to wash all normal items, except delicate fabrics such as wool or silk.

! NOTE

- If you press the Power button and the Start/Pause button without selecting another cycle, the washing machine defaults to the Cotton/Normal cycle.

Allergiene™: Help Prevent Allergens

This cycle helps to remove allergens such as house mites, pollen, and cat hair.

Hand Wash/Wool: Items Labeled Wool or Hand-Wash

This cycle is for washing shrinkable woolen or hand-washable items requiring delicate care. Only wash woolen items that are labeled machine washable or hand-washable.

! NOTE

- Laundry weight should be less than 8 pound (3.6 kg) to prevent damage to the fabric.
- Use only natural or wool-safe detergent harmless to fabrics and load 1/2 of the normal amount of detergent.
- The Hand Wash/Wool cycle uses a gentle tumble rotation angle and low speed spin for the ultimate fabric care.

Delicates: Sheer Items

This cycle is for washing lingerie or sheer and lacy clothes which can easily be damaged.

Quick Wash: Washing Quickly

Use the Quick Wash cycle to quickly wash lightly soiled clothing and small loads. For high wash and rinse efficiency, wash small loads of 2-3 lightly soiled garments

! NOTE

- Use very little detergent in this cycle. For additional rinsing, add an extra rinse using the option button.

Wash+Dry: A Small Load Which Can Be Tumble Dried

This cycle washes and dries clothing in one continuous cycle.

Drain+Spin: Drain and Spin Only

This cycle is for draining and spinning without the wash and rinse cycle, or for removing the load from the washing machine in the middle of the cycle.

Cycle Modifier Buttons

Each cycle has preset settings that are selected automatically. You may also customize the settings using the cycle modifier buttons. Press the button for that option to view and select other settings. The washer automatically adjusts the water level for the type and size of wash load for best results and maximum efficiency. It may seem there is no water inside the drum in some cycles, but this is normal.

NOTE

- To protect your garments, not every wash/rinse temperature, spin speed, soil level, or option is available with every cycle. See the Cycle Guide for details

Setting Options Before Cycle

You can select and add the desired optional functions before you start the washing machine.

Temp.

Set the water temperature for the wash cycle. Set the appropriate temperature, as specified in the fabric care label.

- 1 Press the Power button and turn the cycle selector knob in either direction to select the desired cycle.
- 2 Press the Wash Temp button repeatedly to select the desired water temperature:
 - When you press the button, an indicator light for the corresponding selection will turn on in the display.
- 3 You can now modify other cycle settings and add options (see pages 25-28), or proceed to step 4 to begin the cycle.
- 4 Press the Start/Pause button.

NOTE

- Cold rinses use less energy.
- Your washer features a heating element to boost the hot water temperature for Extra Hot settings. This provides improved wash performance at normal water heater settings.
- Select the water temperature suitable for the type of load you are washing. Follow the fabric care label for best results.

Spin

You can set the desired spin speed. Use this feature properly according to the characteristics of the load.

- 1 Press the Power button and turn the cycle selector knob in either direction to select the desired cycle.
- 2 Press the Spin Speed button repeatedly to select the desired spin speed.
 - When you press the button, an indicator light for the corresponding selection will turn on in the display.
- 3 You can now modify other cycle settings and add options (see pages 25-28), or proceed to step 4 to begin the cycle.
- 4 Press the Start/Pause button.

NOTE

- The Spin Speed button also activates the Drain & Spin cycle to drain the tub and spin clothes; for example, if you want to remove clothes before the cycle has ended.

Dry ()

Press the Dry button to select drying options.

- For consistently dry loads, all articles in the load should be similar in material and thickness.
- Do not overload the drum. Items must have room to tumble freely.
- Press Start/Pause to remove items before the dry cycle has finished.

Press the Dry button repeatedly to toggle through the selections:

By pressing the Dry button, you can select:

- Low Temp. - For delicate fabrics
- Damp Dry - For damp drying fabrics
- Normal - For general drying
- Normal Eco - For heavier fabrics
- Time 30/60/120 - For timed drying

! NOTE

- The capacity of the machine for washing clothes is twice as much as when drying clothes. If the machine is to be used to dry a load, then the wash load must be reduced by half for effective drying performance. If a full load is washed, remove half the clothes prior to starting the dry cycle.

Drying Guide—Automatic Dry

Electronic sensors measure the temperature of the exhaust to increase or decrease the drying temperature for faster reaction time and tighter temperature control.

Recommended DRY settings by fabric type:

- Perm. Press – Low Temp.
- If clothes are to be ironed – Damp Dry
- Cotton/Towels – Normal
- Diapers – Normal Eco

! NOTE

- On Automatic Dry settings, the estimated drying time may vary from the actual drying time. The type of fabric, size of the load, and the selected dryness level affect drying time.

Drying Guide—Timed Dry

- Press the Dry button repeatedly to select the drying time in 30 minute increments: 30/60/120 minutes.
- Timed dry can last up to 120 min. When selecting Dry only, drying will start after the final Spin cycle.
- The time required to dry a load can vary greatly depending on dampness, room temperature, and type of fabric. You may need to add additional time. Your own experience will be your best guide.

Dry Only Cycle

- 1 Press Power. Do not turn the cycle selector knob.
- 2 Press Dry repeatedly to select the desired dry cycle.
- 3 Press Start.

! NOTE

- If you turn the cycle selector knob, you will be unable to select a Dry Only cycle. If this occurs, press Power twice to cycle the machine off and back on.
- All Dry Only cycles begin with a brief spin cycle to extract as much moisture as possible from the load before drying.

Drying Tips

Woolen Articles

Do not tumble dry woolen articles. Block them (pull them to their original shape) and dry them flat.

Woven and Loopknit Materials

- Some woven and loopknit materials may shrink when dried.
- Always stretch them out immediately after drying.

Permanent Press and Synthetics

- Do not overload the dryer.
- To reduce wrinkles, take out permanent press articles as soon as the dryer stops.

Fiber or Leather Materials

Always check the manufacturer's instructions.

Baby Clothes and Night Gowns

Always check the manufacturer's instructions.

Rubber and Plastics





Do not dry any items made from or containing rubber or plastics, such as:

- a) Aprons, bibs, chair covers
- b) Curtains and tablecloths
- c) Bathmats

Fiberglass

Do not dry fiberglass articles in the dryer. Glass particles left in the washer could be picked up by clothes in the next load and irritate skin.

Dry Cycles

Cycle	Description	Fabric Type
Normal 	For cottons. Reduces the drying time and energy usage during the dry cycle.	Cotton or linen fabrics such as cotton towels, t-shirts, and linen clothing.
Normal Eco 	Saves energy.	
Low Temp. 	Uses low temperature dry to protect clothing.	Easy care or permanent press fabrics.
Damp Dry 	Leaves clothes slightly damp for easier ironing.	Cotton or linen fabrics, ready to iron at the end of cycle.
Time 30 min.	You can change the drying time according to the maximum load.	Cotton, towel
Time 60 min.		
Time 120 min.		

Delay Wash

Set the desired start time for the cycle.

- 1 Press the Power button and turn the cycle selector knob in either direction to select the desired cycle.
- 2 Modify the cycle settings and add other options (see pages 25-28), if desired.
- 3 Press the Delay Wash button repeatedly to select the desired start time.
 - The Delay Wash indicator light will turn on.
 - The set start time appears on the display panel.
 - Each press of the button increases the delay time by 1 hour, from 3 hours up to 19 hours.
- 4 Press the Start/Pause button.

Steam ()

Steam Wash features enhanced washing performance with low energy consumption.

- 1 Press the Power button.
- 2 Select a compatible wash cycle (see Cycle Guide).
- 3 Press the Steam button.
- 4 Press the Start/Pause button.

Wi-Fi ()

Set the Wi-Fi connection. When Wi-Fi is connected, the Wi-Fi icon on the control panel is lit.

Pre-wash ()

Pre-wash for 17 minutes when clothes are covered in dirt or dust. This feature is suitable for heavily soiled items.

- 1 Press the Power button and turn the cycle selector knob in either direction to select the desired cycle.
- 2 Press the Pre-wash button.
 - The indicator light will turn on.
- 3 You can now modify other cycle settings and add options (see pages 25-28), or proceed to step 4 to begin the cycle.
- 4 Press the Start/Pause button.

Signal On/Off

The washing machine plays a melody when the wash cycle is finished. The buttons make a sound each time a button is pressed.

- 1 Press the Power button and turn the cycle selector knob in either direction to select the desired cycle.
- 2 Press and hold the Pre-wash button for 3 seconds.
- 3 Press the Start/Pause button.

Setting Options During Cycle

You can add the desired options during the wash cycle.

Control Lock

You can lock the washing machine to prevent children or others from changing the cycle settings by pressing the buttons during the cycle.

Enabling Control Lock

Press and hold the Pre-wash and Delay Wash buttons for 3 seconds during the wash cycle.

- When the Control Lock is enabled, a message and the remaining wash time are displayed, in turn, on the display panel of the washing machine.

Disabling Control Lock

(When the Control Lock is activated.)

Press and hold the Pre-wash and Delay Wash buttons for 3 seconds during the wash cycle.

! NOTE

- Control Lock lasts after the end of the cycle. If you want to deactivate this function, press and hold the Pre-wash and Delay Wash buttons for 3 seconds.

EcoHybrid ()

Use for air condensing dry without water consumption used for condensing.

- 1 Press the Power button.
- 2 Select a dry cycle.
- 3 Press the Eco Hybrid button for 3 seconds.
- 4 Press the Start/Pause button.

! NOTE

- Available with the Normal Dry or Damp Dry cycles.

Heavy Soil ()

Select this option to wash heavily soiled laundry with more power than the standard cycle. Press and hold the Steam button for 3 seconds to select the option.

Add Garments ()

Garments can be added or removed after the cycle is started.

- 1 Press the Add Garments button.
- 2 The door lock is released to open the door.
- 3 Add or remove laundry.
- 4 To continue the cycle, press the Start/Pause button again. The cycle continues automatically.

! NOTE

- For safety reasons, the door remains locked when the water level or temperature is high. It is not possible to add laundry during this time.

MAINTENANCE

Regular Cleaning

Care After Wash

After the cycle is finished, wipe the door and the inside of the door seal to remove any moisture. Leave the door open to dry the washer tub interior. Wipe the body of the washing machine with a dry cloth to remove any moisture.

⚠ WARNING

- Unplug the washer before cleaning to avoid the risk of electric shock. Failure to follow this warning can cause serious injury, fire, electric shock or death.
- Never use harsh chemicals, abrasive cleaners, or solvents to clean the washer. They will damage the finish.
- Do not use volatile substances (benzene, paint thinner, alcohol, acetone, etc.) or detergents with strong chemical components when cleaning the washing machine. Doing so may cause discoloration or damage to the machine, or it may cause a fire.
- Certain internal parts are intentionally not grounded and may present a risk of electric shock only during servicing. Service personnel - Do not contact the following parts while the appliance is energized: pump, valve, motor, control board.

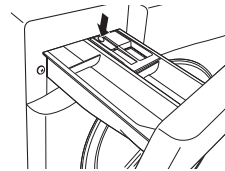

- 6 Press the Spin Speed button for draining and spinning.
- 7 Press the Start/Pause button.
 - Drain the water from the washing machine for 1 minute. Not all of the RV antifreeze will be expelled.
- 8 Press the Power button to turn off the washing machine and pull out the power plug.
- 9 Dry the interior of the washer tub with a soft cloth, and close the door.

- 10 Press down hard on the disengage button and pull out the detergent dispenser drawer.
- 11 Drain the water from the detergent dispenser drawer and dry out each compartment.
- 12 Store the washing machine in an upright position.

! NOTE

- To remove the antifreeze after storing the washing machine, add detergent to the dispenser, and run one cycle. Do not load any laundry at this time.

Care in Cold Climates

Long-Term Storage

Follow these instructions when storing the washer for an extended period where it might be exposed to freezing temperatures.

- 1 Turn off the faucets connected with the water lines.
- 2 Unscrew the water lines from the back of the washer.

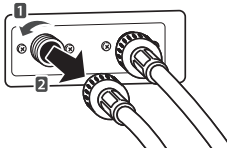

- 3 Empty any water out of the water lines.
- 4 Press the Power button.
- 5 Open the door and add 1 gallon (3.8 L) of nontoxic recreational vehicle (RV) antifreeze to the empty washer tub. DO NOT use automotive anti-freeze. Close the door.

Thawing Frozen Water Lines

- 1 Turn off the faucets connected with the water lines.
- 2 Pour hot water on the frozen faucets to thaw the water lines and pull them out.
- 3 Immerse the water lines in hot water to thaw them.
- 4 Connect the water lines with the water inlets of the washing machine and faucets.
 - See page 14, Connecting the water lines for details.
- 5 Turn on the faucets.
- 6 Press the Power button.
- 7 Press the Rinse+Spin button.
- 8 Press the Start/Pause button.
 - Verify the water fills properly.

Thawing a Frozen Drain Line

- 1 Pour hot water in the washer tub and close the door.
 - Leave it for 10 minutes.
- 2 Press the Power button after 10 minutes.
- 3 Press the Spin Speed button for draining and spinning.
- 4 Press the Start/Pause button.
 - Check if the water drains.

Cleaning

Periodically clean the washing machine to help maintain its performance and to minimize the chance of malfunction.

Tub Clean

Improper installation or use of the washing machine in a humid space for a long period of time could lead to a buildup of detergent residue in the washing machine that may produce mildew or musty smells. If you clean the washer tub regularly on a monthly basis using Tub Clean it will minimize the possibility that detergent residue will build up and mildew or musty smells may occur.

- 1 Add liquid chlorine bleach or tub cleaner to the detergent compartment.

Some powder or tablet tub cleaners which are manufactured for this purpose can be used. (Do not add any laundry detergent or fabric softener to the drawer when using Tub Clean.)

 - **If using powder cleaner**
Add powder cleaner to the main wash compartment of the drawer.
 - **If using tablet cleaner**
Add tablet cleaner to the wash drum directly. (Do not add tablet cleaner to the drawer.)
- 2 Press the Power button.
- 3 Turn the cycle selector knob to select Tub Clean.
 - tcl message appears in the display.
 - The indicator light for Tub Clean turns on.
- 4 Press the Start/Pause button.

NOTE

- Never load laundry while using Tub Clean. The laundry may be damaged. Make sure to clean the washer tub when it is empty.
- Leave the door open after finishing the laundry to help keep the tub clean.
- Repeat the Tub Clean cycle monthly.
- If you notice mildew or musty smells, run Tub Clean once a week for three consecutive weeks.

Automatic Alert

When the power is on and the **⚠** message blinks, it means the washer tub needs cleaning. Use Tub Clean to clean the washer tub. The automatic indicator alert for cleaning the washer tub depends on the frequency of use, however, the message will generally blink every 1~2 months.

Removing Mineral Buildup

If you live in an area with hard water, mineral scale can form on the internal components of the washing machine. Take extra care to periodically clean the mineral buildup on the internal components to extend the lifespan of the washing machine.

Check if the descaler is suitable for cleaning the washer tub before using it and run the Tub Clean cycle. See page 30, Tub clean for details on tub clean.

NOTE

- In areas with hard water, use of a water softener is recommended.
- Make sure to remove all laundry from the washer tub before cleaning the washer tub. Cleaning the washer tub together with laundry may result in contamination of or damage to the laundry.

Removing Lime Buildup on Stainless Steel

Wipe lime buildup or other spots on stainless steel with a soft cloth soaked in stainless steel cleaner.

NOTE

- Never use steel wool or abrasive cleansers. Doing so may damage the washing machine.

Cleaning the Detergent Dispenser Drawer

Leaving detergent in the detergent dispenser drawer for an extended period of time or using the washing machine for a long period of time may cause the build-up of scales in the detergent dispenser drawer. Pull out and clean the detergent dispenser drawer once a week.

- 1 Pull out the detergent dispenser drawer.
- 2 Press down hard on the disengage button and pull out the detergent dispenser drawer.

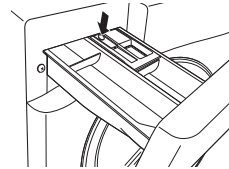

- 3 Remove the inserts from the drawer.

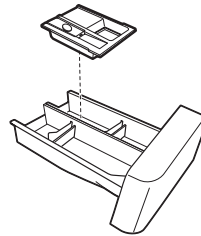

- 4 Clean them with warm water.
 - Use a soft cloth or brush for cleaning and remove any residue.
- 5 Wipe any moisture with a dry towel or cloth after cleaning.
- 6 Replace the detergent dispenser drawer.

WARNING

- Do not spray water inside the washing machine. Doing so may cause fire or electric shock.

NOTE

- Use only water to clean the detergent dispenser drawer. Make sure to use Rinse+Spin to rinse the washer tub before the next wash cycle when using a cleaning detergent to clean the washer tub.

Cleaning the Water Inlet Filters

Clean the water inlet filters periodically to prevent clogging. Take extra care to clean the water inlet filters in areas using hard water. Water may not be supplied if there are foreign objects, such as rust, sand, or stones in the water inlet filters.

- 1 Press the Power button to turn off the washing machine and pull out the plug.
- 2 Turn off the faucets connected with the water inlets.
- 3 Remove the water inlets.

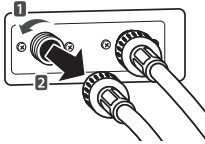

- 4 Pull out the water inlet filter.

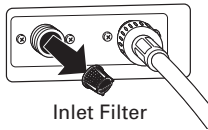

- 5 Remove foreign objects from the water filter inlet.
 - Soak the water filter inlets in white vinegar or a lime scale remover or use a toothbrush to remove foreign objects and rinse thoroughly.
- 6 Press the water filter inlets back into place.
- 7 Reattach the water lines to the washing machine.

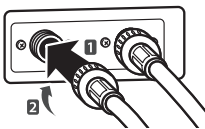

⚠ WARNING

- **Unplug the power cord and turn off the faucets before cleaning.** Failure to do so may cause electric shock.
- **Do not use the washing machine without the inlet filters.** If you use the washing machine without the inlet filters it will cause leaks and malfunction.
- If you use the washing machine in an area with hard water, the inlet filter may clog due to lime buildup. Contact your nearest LG customer service center if the inlet filter cannot be cleaned or is missing.

ⓘ NOTE

- ***i* E** message will blink on the display when the water pressure in the detergent drawer is weak or an inlet filter is clogged with dirt. Clean the inlet filter.

Cleaning the Drain Pump Filter

The washing machine fails to drain if the drain pump filter is clogged. Periodically clean the drain filter to prevent clogging with foreign objects.

- 1 Press the Power button to turn off the washing machine and pull out the plug.
- 2 Open the drain pump filter cover.

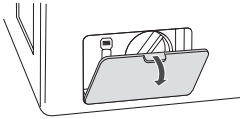

- 3 Unclip the drain hose and remove the plug from the drain hose to drain the remaining water.

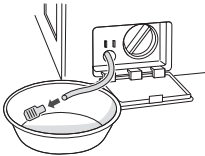

- 4 Twist the pump filter counterclockwise to remove it.

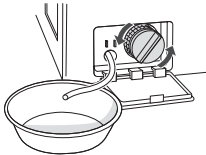

- 5 Clean the pump filter and opening.

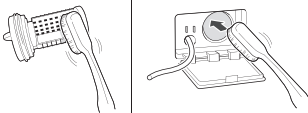

- 6 Recap the plug onto the drain hose and reattach the drain hose.

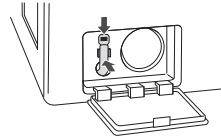

- 7 Insert the drain pump filter.

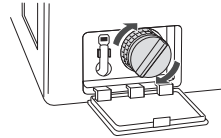

- 8 Close the drain pump filter cover.

⚠ WARNING

- Make sure to pull out the plug before cleaning. Failure to do so may cause electric shock.
- Opening the drain filter will result in water overflowing if there is water in the washer tub. Make sure to check if the water is completely drained before opening the drain filter.
- If you use the washing machine with the drain filter reassembled incorrectly after cleaning it, or if you use the machine without the filter, it may cause leaks or malfunction of the washing machine.

ⓘ NOTE

- **UE** message will blink when the drain pump filter is clogged with dirt. Clean the drain pump filter.

Cleaning the Door Seal

Clean the door seal once a month to prevent build-up of dirt in the door seal.

- 1 Wear rubber gloves and protective goggles.
- 2 Dilute 3/4 cup (177 ml) of liquid chlorine bleach in 1 gallon (3.8 L) of water.
- 3 Soak a sponge or a soft cloth in this diluted solution and wipe down all around the door seal.
- 4 Wipe any moisture with a dry towel or cloth after cleaning.
- 5 Leave the door open to allow the door seal to dry completely.









CAUTION



- Cleaning the door seal with undiluted liquid chlorine bleach may cause malfunction of the door seal and washing machine parts.

TROUBLESHOOTING

Checking Error Messages

If the following message appears on the display, check the following and take the appropriate corrective action.

Message	Possible Causes	Solutions
	<p>Item of clothing has gathered on one side of the tub.</p> <ul style="list-style-type: none"> • There are not enough items in the machine. • Have your items gathered in one area, or is the load too small? • Did you wash a stuffed animal, a mat, or knitwear? • Did you wash two different blankets together? 	<ul style="list-style-type: none"> • Rearrange items to help balance the load. • Stuffed animals or mats can become unbalanced during spinning and the washing machine may fail to drain. Rearrange the knitwear to help balance the load and drain it again. • Put one blanket in at a time.
	<p>Water is not supplied or the water pressure is low</p> <ul style="list-style-type: none"> • Is the faucet turned off? • Is the water supply stopped or the faucet frozen? • Is the water pressure low or is an inlet filter clogged? • Is the water line properly connected with the cold water inlet? • Is the water line pinched or bent? 	<ul style="list-style-type: none"> • Turn on the faucets. • If a faucet is frozen, thaw it with warm water. • If the inlet filter is clogged, clean it. (see page 32) • Connect the water line properly with the cold water inlet. (see page 14) • Check that the water lines are not pinched or bent. Take extra care that water lines are not twisted or pinched by other objects.
	<p>Water line leaks in connection</p> <ul style="list-style-type: none"> • Are the water lines connected with the faucets properly? 	
  	<p>The tub does not rotate</p> <ul style="list-style-type: none"> • Is the door secured? 	<ul style="list-style-type: none"> • Close and secure the door. If the message keeps appearing, unplug the power and contact your nearest LG service center.
	<p>The washing machine drains slowly or not at all</p> <ul style="list-style-type: none"> • Is the drain hose installed over 3 1/4 feet (1 m) beyond the end of the elbow bracket? • Is the drain hose pinched or clogged inside? • Is the drain hose frozen? • Is the drain hose clogged with foreign objects? 	<ul style="list-style-type: none"> • Lower the drain hose within 3 feet below the end of the elbow bracket. • Place the drain hose on a smooth surface to prevent bending. • If the drain hoses are frozen, thaw them in warm water. • Open the drain pump plug cap and remove the dirt.
	<p>A power failure has occurred.</p>	
	<p>Control Error.</p>	<ul style="list-style-type: none"> • Unplug the power cord and contact your nearest LG service center.
	<p>The water supply does not stop</p> <ul style="list-style-type: none"> • Do the water supply and the drain keep repeating in turn? 	<ul style="list-style-type: none"> • Unplug the power cord and contact your nearest LG service center
	<p>The water level is not controlled</p> <ul style="list-style-type: none"> • Is the water level too low or high compared with the size of the load? 	
	<p>Check water supply.</p>	<ul style="list-style-type: none"> • Turn the faucet on. If "dHE" error code persists, unplug power plug and call for service.

Message	Possible Causes	Solutions
	<p>The tub does not rotate</p> <ul style="list-style-type: none"> Is the washing machine overloaded? 	<ul style="list-style-type: none"> Rearrange the load size and restart the washing machine. If the load size is big, the tub may not rotate due to an overheated motor. Allow the washing machine to stand for a while and restart the cycle. Unplug the power cord and contact your nearest LG service center if the same error message appears.
	<ul style="list-style-type: none"> To clean up the tub, please run the TUB CLEAN cycle. 	<ul style="list-style-type: none"> Please empty the tub and insert bleach into the detergent dispenser and select the Tub Clean cycle. If you want to skip the Tub Clean, turn the CYCLE SELECTOR KNOB or push the option buttons to select a cycle. The message will keep appearing until a few wash cycles have been completed, then it will disappear until the next scheduled time to clean the tub.
	<ul style="list-style-type: none"> Water lines are frozen. Drain line or pump is frozen. 	<ul style="list-style-type: none"> Unfreeze the water outlet hose and drain pump by pouring hot water into the washer. Close the door/lid and wait for 1-2 hours. Unfreeze the water inlet line by wetting a towel in warm water and wrapping it around the frozen faucet. See Care in Cold Climates for further information.

Before Calling for Service

Check the following before calling for service.

Problem	Possible Causes	Solutions
Clicking sound	<ul style="list-style-type: none"> Do you hear a sound when you close or lock and unlock the door? 	<ul style="list-style-type: none"> This sound is normal and occurs when the door is closed, locked or unlocked.
Spraying or hissing sound	<ul style="list-style-type: none"> Is water spraying in the tub? 	<ul style="list-style-type: none"> This sound is normal as water is spraying or circulating during the cycle.
Buzzing or gushing sound	<ul style="list-style-type: none"> Is the washing machine draining water? 	<ul style="list-style-type: none"> This sound is normal as the drain pump drains water from the washing machine after the cycle.
Splashing sound	<ul style="list-style-type: none"> Is the washing machine washing a load of laundry? 	<ul style="list-style-type: none"> This sound is normal as the load is moving up and down during the wash and rinse cycles.
Rattling and clanking noise	<ul style="list-style-type: none"> Are there any foreign objects such as keys, coins, or safety pins in the tub or drain filter? 	<ul style="list-style-type: none"> Check if there are any foreign objects in the tub and drain the filter after stopping the cycle. Unplug the power cord and contact your nearest LG service center if the noise persists.
Thumping sound	<ul style="list-style-type: none"> Is the washing machine overloaded? Is the load out of balance? 	<ul style="list-style-type: none"> This sound is normal and occurs when the load is out of balance. Stop the cycle and rearrange the load for balancing.

Problem	Possible Causes	Solutions
Vibrating noise	<ul style="list-style-type: none"> • Are the shipping bolts removed? • Is the load evenly distributed in the tub? • Is the washing machine level balanced? • Is the washing machine installed on a solid and smooth surface? 	<ul style="list-style-type: none"> • See page 13, Unpacking and Removing Shipping Bolts, to remove the shipping bolts. • Stop the cycle and rearrange the load for balancing. • See page 16, Leveling the Washer, to level the washing machine. • Check if the floor is solid and level.
Water leaking around washer	<ul style="list-style-type: none"> • Is water leaking from a faucet or a water line? • Is a drain pipe or a drain hose clogged? 	<ul style="list-style-type: none"> • Check the faucets or water lines. <ul style="list-style-type: none"> - If the water lines are loosely connected, see page 14, Connecting Water Lines, to connect them properly. • Unclog the drain pipe or drain hose. Contact a plumber if necessary.
Excessive suds or failure to rinse	<ul style="list-style-type: none"> • Did you use more than the recommended amount of detergent? • Is the soil level higher than the size of the load? 	<ul style="list-style-type: none"> • Use the recommended amount of detergent for the load. • If the soil level is low, reduce the detergent quantity to less than the recommended level. <p> Only use detergent with the HE (High-Efficiency) logo.</p>
Staining	<ul style="list-style-type: none"> • Did you add detergent directly to the tub? • Did you remove the load immediately after it finished? • Did you sort and wash the clothes by color or soil? 	<ul style="list-style-type: none"> • Make sure to load detergent into the detergent dispenser drawer. • Remove the load immediately after it finishes. • Sort and separate dark colors from light or white ones, and heavily soiled items from lightly soiled ones. See page 19, Sorting Laundry, for details
Wrinkling	<ul style="list-style-type: none"> • Did you remove the load immediately after it finished? • Did you overload the tub? • Did you reverse the hot and cold water inlets? 	<ul style="list-style-type: none"> • Remove the load immediately after it finishes. • Do not overload the tub. • Hot water rinse can cause garments to wrinkle. Check the inlet hose connections.
Power will not turn on	<ul style="list-style-type: none"> • Is the power cord plugged in properly? • Has a house fuse blown, a circuit breaker tripped, or a power outage occurred? 	<ul style="list-style-type: none"> • Make sure that the plug is secured in a grounded 3-prong, 120 V (60 Hz) outlet. • Reset the circuit breaker or replace the fuse. Do not increase the fuse capacity. If the problem is a circuit overload, have it corrected by a qualified electrician.
The door does not open when the cycle pauses or finishes	<ul style="list-style-type: none"> • Is the temperature in the tub too high? • Is the water level in the washer high? 	<ul style="list-style-type: none"> • The washing machine has a safety lock built into the door to prevent burning. Leave the door closed and wait until the door lock icon disappears from the display. • Allow the washer to complete the programmed cycle, or press the SPIN button.
The wash cycle time is longer than usual	<ul style="list-style-type: none"> • Is the washing machine overloaded? Are other options added to the wash cycle? 	<ul style="list-style-type: none"> • This is normal. The washing machine automatically adjusts the cycle time for the amount of laundry, water pressure, water temperature, and other operating conditions.
It is musty or moldy in the tub	<ul style="list-style-type: none"> • Has the incorrect detergent been used? • Did you clean the tub periodically? 	<ul style="list-style-type: none"> • Use only HE (High-Efficiency) detergent recommended for a front-loading washing machine. • See page 30, clean the inside and outside of the washing machine periodically.

Problem	Possible Causes	Solutions
Banging noise when washer is filling with water (Water Hammer)	<ul style="list-style-type: none"> • Plumbing in the home moves or flexes when the water valves in the washer shut off. • Household water supply pressure is very high. 	<ul style="list-style-type: none"> • Water hammer is not caused by a defect in the washer. Install water hammer arrestors (purchased separately at hardware or home improvement store) between the fill hose and the washer for best results. • Adjust household water supply regulator to a lower pressure or contact a plumber to have a regulator installed.
Strange odors coming from washer	<ul style="list-style-type: none"> • Heater in dryer. • First time using washer • Buildup of dirt on gasket or drum, dirty or clogged drain pump filter, kinked or clogged drain hose 	<ul style="list-style-type: none"> • During the initial phase of operation, lint from laundry can settle on the heater and cause odors. This is normal and will not affect performance. • Smell comes from the rubber attached to the washer door. It will eventually dissipate after first couple of wash cycles. • Periodically clean the gasket. Mold and foreign substances inside the gasket may produce mildew or musty smells. • Clean the drain pump filter regularly. Foreign substances on the drain pump filter may produce mildew or musty smells. • If the drain hose is not installed properly, the odor may be emitted because of a backflow of drainage into the tub. Make sure that the drain hose is not kinked or clogged.
Odor	<ul style="list-style-type: none"> • This odor is caused by the rubber attached to the washing machine. • If the rubber door gasket and door seal area are not cleaned regularly, odors can occur from mold or foreign substances. • Odors can occur if foreign substances are left in the drainage pump filter. • Odors can occur if the drainage hose is not properly installed, causing siphoning (water flowing back inside the washing machine). • Using the dry function, odors can occur from lint and other laundry matter sticking to the heater. (Dryer model only) • A particular odor can occur from drying wet clothes with hot air. (Dryer model only) 	<ul style="list-style-type: none"> • It is the normal odor of new rubber and will disappear after the machine has been run a few times. • Be sure to clean the gasket and door seal regularly and check under the door seal for small items when unloading the washer. • Be sure to clean the drainage pump filter regularly. • When installing the drainage hose, be sure that it doesn't become kinked or blocked. • This is not a malfunction. • The odor will disappear after a short while.



Problem	Possible Causes	Solutions
Your home appliance and smartphone is not connected to the Wi-Fi network.	The password for the Wi-Fi that you are trying to connect to is incorrect.	<ul style="list-style-type: none"> Find the Wi-Fi network connected to your smartphone and remove it, then register your appliance on LG SmartThinQ.
	Mobile data for your smartphone is turned on.	<ul style="list-style-type: none"> Turn off the Mobile data of your smartphone and register the appliance using the Wi-Fi network.
	The wireless network name (SSID) is set incorrectly.	<ul style="list-style-type: none"> The wireless network name (SSID) should be a combination of English letters and numbers. (Do not use special characters.)
	The router frequency is not 2.4 GHz.	<ul style="list-style-type: none"> Only a 2.4 GHz router frequency is supported. Set the wireless router to 2.4 GHz and connect the appliance to the wireless router. To check the router frequency, check with your Internet service provider or the router manufacturer.
	The distance between the appliance and the router is too far.	<ul style="list-style-type: none"> If the distance between the appliance and the router is too far, the signal may be weak and the connection may not be configured correctly. Move the location of the router so that it is closer to the appliance.

SPECIFICATIONS

Model WM3499H*A	
Description	Front-loading washing machine
Electrical requirements	120 VAC @ 60 Hz
Dimensions	60.96 cm(W) x 64.50 cm(D) x 85.09 cm(H) 114.90 cm (D, door open) 24"(W) x 25.40"(D) x 33.50"(H) / 45" (D, door open)
Capacity	2.3 cu.ft (IEC2.6 cu.ft) (Dry linen capacity 6 kg)
Net weight	72 kg (159 lbs)
Max. spin speed	1,400 rpm/min max
Max. water pressure	20 – 120 psi (138 – 827 kPA)

SMART FUNCTIONS

Using Smart Diagnosis™

For appliances with the  or  logo

This gives you the capability of speaking directly to our trained specialists. The specialist records the data transmitted from the appliance and uses it to analyze the issue, providing a fast and effective diagnosis.



- 1 Call the LG Electronics Customer Information Center at:
(LG U.S.A.) 1-800-243-0000
(LG Canada) 1-888-542-2623
- 2 When instructed to do so by the call center, place the mouthpiece of the phone close to the Smart Diagnosis™ icon. Do not press any other buttons.
- 3 Press and hold the  button for 3 seconds.
- 4 Keep the phone in place until the tone transmission has finished.
 - For best results, do not move the phone while the tones are being transmitted.
 - It may take a few tries to get an accurate recording of the data.
- 5 Once the countdown is over and the tones have stopped, resume your conversation with the call center agent, who will assist you using the information transmitted for analysis.

NOTE

- Smart Diagnosis™ cannot be activated unless the appliance can be turned on using the  button. If the appliance cannot be turned on, troubleshooting must be done without using Smart Diagnosis™.
- For best results, do not move the phone while the tones are being transmitted.
- If the call center agent is not able to get an accurate recording of the data, you may be asked to try again.
- The Smart Diagnosis™ function depends on the local call quality.
- Bad call quality may result in poor data transmission from your phone to the call center, which could cause Smart Diagnosis™ to malfunction.

Using LG SmartThinQ Application

Things to check before using LG SmartThinQ

- For appliances with the  or  logo
- 1 Check the distance between the appliance and the wireless router (Wi-Fi network).
 - If the distance between the appliance and the wireless router is too far, the signal strength becomes weak. It may take a long time to register or installation may fail.

- 2 Turn off the Mobile data or Cellular Data on your smartphone.
 - For iPhones, turn data off by going to Settings → Cellular → Cellular Data.

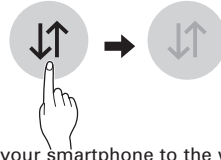

- 3 Connect your smartphone to the wireless router.

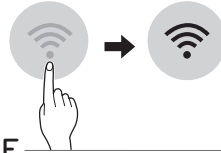

NOTE

- To verify the Wi-Fi connection, check that Wi-Fi icon on the control panel is lit.
- The appliance supports 2.4 GHz Wi-Fi networks only. To check your network frequency, contact your Internet service provider or refer to your wireless router manual.
- LG SmartThinQ is not responsible for any network connection problems or any faults, malfunctions, or errors caused by network connection.
- If the appliance is having trouble connecting to the Wi-Fi network, it may be too far from the router. Purchase a Wi-Fi repeater (range extender) to improve the Wi-Fi signal strength.
- The Wi-Fi connection may not connect or may be interrupted because of the home network environment.
- The network connection may not work properly depending on the Internet service provider.
- The surrounding wireless environment can make the wireless network service run slowly.
- The appliance cannot be registered due to problems with the wireless signal transmission. Unplug the appliance and wait about a minute before trying again.
- If the firewall on your wireless router is enabled, disable the firewall or add an exception to it.
- The wireless network name (SSID) should be a combination of English letters and numbers. (Do not use special characters.)
- Smartphone user interface (UI) may vary depending on the mobile operating system (OS) and the manufacturer.
- If the security protocol of the router is set to WEP, you may fail to set up the network. Please change it to other security protocols (WPA2 is recommended) and register the product again.

Installing LG SmartThinQ

Search for the LG SmartThinQ application from the Google Play Store or Apple App Store on a smart phone. Follow instructions to download and install the application.

Wi-Fi Function

- For appliances with the  or  logo
Communicate with the appliance from a smart phone using the convenient smart features.

Washer Cycle (Remote Start, Downloaded)

Set or download any preferred cycle and operate by remote control.

Tub Clean Coach

This function shows how many cycles remain before it is time to run the Tub Clean cycle.

Energy Monitoring

Check the energy consumption of the recently used cycles and monthly average.

Smart Diagnosis™

This function provides useful information for diagnosing and solving issues with the appliance based on the pattern of use.

Settings

Various functions are available.

Push Alert

Turn on the Push Alerts to receive appliance status notifications. The notifications are triggered even if the LG SmartThinQ application is off.

NOTE

- If you change your wireless router, Internet service provider, or password, delete the registered appliance from the LG SmartThinQ application and register it again.
- The application is subject to change for appliance improvement purposes without notice to users.
- Functions may vary by model.

Remote Start

Use a smart phone to control your appliance remotely. You can also monitor your cycle operation so you know how much time is left in the cycle.

- 1 Press the Power button.
- 2 Put the laundry in drum.
- 3 Press and hold Remote Start button for 3 seconds to enable Remote Start function.
- 4 Start a cycle from the LG Smart ThinQ application on your smart phone.

! NOTA

- Once the Remote Start mode is enabled, you can start a cycle from the LG Smart ThinQ smartphone application. If the cycle is not started, the machine will wait to start the cycle until it is turned off remotely from the application or the Remote Start mode is disabled.
- When Remote Start is turned on, the door is automatically locked.

To Disable Remote Start:

When the Remote Start is activated, press and hold Remote Start button for 3 seconds.

Downloaded

Download new and special cycles that are not included in the basic cycles on the appliance.

Appliances that have been successfully registered can download a variety of specialty cycles specific to the appliance.

Only one cycle can be stored on the appliance at a time.

Once cycle download is completed in the appliance, the product keeps the downloaded cycle until a new cycle is downloaded.

Wireless LAN Module Specifications

Model	LCW-004
Frequency Range	2412 - 2462 MHz
Output Power (Max)	IEEE 802.11 b : 22.44 dBm IEEE 802.11 g : 24.68 dBm IEEE 802.11 n : 24.11 dBm

FCC Notice

This equipment has been tested and found to comply with the limits for a Class B digital device, pursuant to Part 15 of the FCC Rules. These limits are designed to provide reasonable protection against harmful interference in a residential installation. This equipment generates, uses, and can radiate radio frequency energy and, if not installed and used in accordance with the instructions, may cause harmful interference to radio communications. However, there is no guarantee that interference will not occur in a particular installation. If this equipment does cause harmful interference to radio or television reception, which can be determined by turning the equipment off and on, the user is encouraged to try to correct the interference by one or more of the following measures:

- Reorient or relocate the receiving antenna.
- Increase the separation between the equipment and the receiver.
- Connect the equipment to an outlet on a circuit different from that to which the receiver is connected.
- Consult the dealer or an experienced radio/TV technician for help.

This device complies with part 15 of the FCC Rules.

Operation is subject to the following two conditions:

- 1) This device may not cause harmful interference and
- 2) This device must accept any interference received, including interference that may cause undesired operation of the device.

Any changes or modifications in construction of this device which are not expressly approved by the party responsible for compliance could void the user's authority to operate the equipment.

FCC RF Radiation Exposure Statement

This equipment complies with FCC radiation exposure limits set forth for an uncontrolled environment. This transmitter must not be co-located or operating in conjunction with any other antenna or transmitter. This equipment should be installed and operated with a minimum distance of 20 cm (7.8 inches) between the antenna and your body. Users must follow the specific operating instructions for satisfying RF exposure compliance.

Open Source Software Notice

Information

To obtain the source code under GPL, LGPL, MPL, and other open source licenses, that is contained in this product, please visit <http://opensource.lge.com>.

In addition to the source code, all referred license terms, warranty disclaimers and copyright notices are available for download.

LG Electronics will also provide open source code to you on CD-ROM for a charge covering the cost of performing such distribution (such as the cost of media, shipping, and handling) upon email request to opensource@lge.com. This offer is valid for three (3) years from the date on which you purchased the product.

WARRANTY

LIMITED WARRANTY (USA)

ARBITRATION NOTICE: THIS LIMITED WARRANTY CONTAINS AN ARBITRATION PROVISION THAT REQUIRES YOU AND LG TO RESOLVE DISPUTES BY BINDING ARBITRATION INSTEAD OF IN COURT, UNLESS YOU CHOOSE TO OPT OUT. IN ARBITRATION, CLASS ACTIONS AND JURY TRIALS ARE NOT PERMITTED. PLEASE SEE THE SECTION TITLED "PROCEDURE FOR RESOLVING DISPUTES" BELOW.

WARRANTY:

LG Electronics U.S.A., Inc. ("LG") warrants your LG Washing Machine ("product") against defect in materials or workmanship under normal household use, during the warranty period set forth below, LG will, at its option, repair or replace the product. This limited warranty is valid only to the original retail purchaser of the product, is not assignable or transferrable to any subsequent purchaser or user, and applies only when the product is purchased through an LG authorized dealer or distributor and used within the United States ("U.S.") including U.S. Territories.

Note: Replacement products and repair parts may be new or factory-remanufactured and are warranted for the remaining portion of the original unit's warranty period or ninety (90) days, whichever is longer. Please retain dated receipt or delivery ticket as evidence of the Date of Purchase for proof of warranty (you may be required to submit a copy to LG or authorized representative).

WARRANTY PERIOD:

Period	One (1) year from date of original retail purchase:	Ten (10) years from date of original retail purchase:	Lifetime from date of original retail purchase:
Scope of Warranty	Any internal /functional Parts & Labor	Drum Motor (Stator and Rotor)	Stainless Steel Drum
Remark	LG will provide parts & labor to repair or replace defective parts.	Parts only. Customer will be responsible for any labor or in-home service to replace defective parts.	

HOW SERVICE IS HANDLED: In-Home Service

In-home service will be provided, as available, during the warranty period subject to servicer availability within the U.S. To receive in-home service, the product must be unobstructed and accessible to service personnel. If the in-home service repair cannot be completed, it may be necessary to remove, repair and return the product. If in-home service is unavailable, LG may elect, at its option, to provide for transportation of the product to and from an LG authorized service center.

THIS LIMITED WARRANTY DOES NOT COVER:

- Service trips to deliver, pick up, or install the product or for instruction on product use.
- Replacing house fuses or resetting of circuit breakers, correction of house wiring or plumbing, or correction of product installation.
- Damage or failure caused by leaky/ broken/ frozen water pipes, restricted drain lines, inadequate or interrupted water supply or inadequate supply of air.
- Damage or failure caused by accidents, pests and vermin, lightning, wind, fire, floods or acts of God.
- Damage or failure resulting from misuse, abuse, improper installation, repair or maintenance. Improper repair includes use of parts not approved or specified by LG.
- Damage or failure caused by unauthorized modification or alteration to the product.
- Damage or failure caused by incorrect electrical current, voltage, or plumbing codes.
- Cosmetic damage, including scratches, dents, chips or other damage to the finish of the product, unless such damage results from defects in materials or workmanship and is reported to LG within seven (7) calendar days from the date of delivery.
- Damage or missing items to any display, open box, discounted, or refurbished product.
- Product where the original factory serial numbers have been removed, defaced or changed in any way.
- Repairs when product is used in other than normal and usual household use (e.g. rental, commercial use, offices, or recreational facilities) or contrary to the instructions outlined in the owner's manual.
- The removal and reinstallation of the Product if it is installed in an inaccessible location.

THIS WARRANTY IS IN LIEU OF ANY OTHER WARRANTY, EXPRESS OR IMPLIED, INCLUDING AND WITHOUT LIMITATION TO, ANY WARRANTY OF MERCHANTABILITY OR FITNESS FOR A PARTICULAR PURPOSE. TO THE EXTENT ANY IMPLIED WARRANTY IS REQUIRED BY LAW, THIS WARRANTY IS LIMITED IN DURATION TO THE TERM PERIOD EXPRESSED ABOVE. REPAIR OR REPLACEMENT AS PROVIDED UNDER THIS WARRANTY IS THE EXCLUSIVE REMEDY FOR THE CUSTOMER. NEITHER THE MANUFACTURER NOR ITS U.S. DISTRIBUTOR SHALL BE LIABLE FOR ANY INCIDENTAL, CONSEQUENTIAL, INDIRECT, SPECIAL, OR PUNITIVE DAMAGES OF ANY NATURE, INCLUDING AND WITHOUT LIMITATION TO, LOST REVENUES OR PROFITS, OR ANY OTHER DAMAGE, WHETHER BASED IN CONTRACT, TORT, OR OTHERWISE.

SOME STATES DO NOT ALLOW THE EXCLUSION OR LIMITATION OF INCIDENTAL OR CONSEQUENTIAL DAMAGES OR LIMITATIONS ON HOW LONG AN IMPLIED WARRANTY LASTS, SO THE ABOVE EXCLUSION OR LIMITATION MAY NOT APPLY TO YOU. THIS WARRANTY GIVES YOU SPECIFIC LEGAL RIGHTS AND YOU MAY ALSO HAVE OTHER RIGHTS THAT VARY FROM STATE TO STATE.

HOW TO OBTAIN WARRANTY SERVICE & ADDITIONAL INFORMATION: Write your warranty information below:

Call 1-800-243-0000 or visit our website at www.lg.com.
Mail to: LG Customer Information Center (ATTN: CIC)
201 James Record Road, Huntsville, AL 35824

Product Registration Information:
Model:
Serial Number:
Date of Purchase:

PROCEDURE FOR RESOLVING DISPUTES:

ALL DISPUTES BETWEEN YOU AND LG ARISING OUT OF OR RELATING IN ANY WAY TO THIS LIMITED WARRANTY OR THE PRODUCT SHALL BE RESOLVED EXCLUSIVELY THROUGH BINDING ARBITRATION, AND NOT IN A COURT OF GENERAL JURISDICTION. BINDING ARBITRATION MEANS THAT YOU AND LG ARE EACH WAIVING THE RIGHT TO A JURY TRIAL AND TO BRING OR PARTICIPATE IN A CLASS ACTION.

Definitions. For the purposes of this section, references to “LG” mean LG Electronics U.S.A., Inc., its parents, subsidiaries and affiliates, and each of their officers, directors, employees, agents, beneficiaries, predecessors in interest, successors, assigns and suppliers; references to “dispute” or “claim” shall include any dispute, claim or controversy of any kind whatsoever (whether based in contract, tort, statute, regulation, ordinance, fraud, misrepresentation or any other legal or equitable theory) arising out of or relating in any way to the sale, condition or performance of the product or this Limited Warranty.

Notice of Dispute. In the event you intend to commence an arbitration proceeding, you must first notify LG in writing at least 30 days in advance of initiating the arbitration by sending a letter to LG at LG Electronics, USA, Inc. Attn: Legal Department-Arbitration 1000 Sylvan Ave, Englewood Cliffs 07632. You and LG agree to engage in good faith discussions in an attempt to amicably resolve your claim. The notice must provide your name, address, and telephone number; identify the product that is the subject of the claim; and describe the nature of the claim and the relief being sought. If you and LG are unable to resolve the dispute within 30 days, either party may proceed to file a claim for arbitration.

Agreement to Binding Arbitration and Class Action Waiver. Upon failure to resolve the dispute during the 30 day period after sending written notice to LG, you and LG agree to resolve any claims between us only by binding arbitration on an individual basis, unless you opt out as provided below. Any dispute between you and LG shall not be combined or consolidated with a dispute involving any other person’s or entity’s product or claim. More specifically, without limitation of the foregoing, any dispute between you and LG shall not under any circumstances proceed as part of a class or representative action. Instead of arbitration, either party may bring an individual action in small claims court, but that small claims court action may not be brought on a class or representative basis.

Arbitration Rules and Procedures. To begin arbitration of a claim, either you or LG must make a written demand for arbitration. The arbitration will be administered by the American Arbitration Association (“AAA”) and will be conducted before a single arbitrator under the AAA’s Consumer Arbitration Rules that are in effect at the time the arbitration is initiated (referred to as the “AAA Rules”) and under the procedures set forth in this section. The AAA Rules are available online at www.adr.org/consumer. Send a copy of your written demand for arbitration, as well as a copy of this provision, to the AAA in the manner described in the AAA Rules. You must also send a copy of your written demand to LG at LG Electronics, USA, Inc. Attn: Legal Department-Arbitration 1000 Sylvan Avenue Englewood Cliffs, NJ 07632. If there is a conflict between the AAA Rules and the rules set forth in this section, the rules set forth in this section will govern. This arbitration provision is governed by the Federal Arbitration Act. Judgment may be entered on the arbitrator’s award in any court of competent jurisdiction. All issues are for the arbitrator to decide, except that issues relating to the scope and enforceability of the arbitration provision and to the arbitrability of the dispute are for the court to decide. The arbitrator is bound by the terms of this provision.

Governing Law. The law of the state of your residence shall govern this Limited Warranty and any disputes between us except to the extent that such law is preempted by or inconsistent with applicable federal law.

Fees/Costs. You do not need to pay any fee to begin an arbitration. Upon receipt of your written demand for arbitration, LG will promptly pay all arbitration filing fees to the AAA unless you seek more than \$25,000 in damages, in which case the payment of these fees will be governed by the AAA Rules. Except as otherwise provided for herein, LG will pay all AAA filing, administration and arbitrator fees for any arbitration initiated in accordance with the AAA Rules and this arbitration provision. If you prevail in the arbitration, LG will pay your attorneys’ fees and expenses as long as they are reasonable, by considering factors including, but not limited to, the purchase amount and claim amount. Notwithstanding the foregoing, if applicable law allows for an award of reasonable attorneys’ fees and expenses, an arbitrator can award them to the same extent that a court would. If the arbitrator finds either the substance of your claim or the relief sought in the demand is frivolous or brought for an improper purpose (as measured by the standards set forth in Federal Rule of Civil Procedure 11(b)), then the payment of all arbitration fees will be governed by the AAA Rules. In such a situation, you agree to reimburse LG for all monies previously disbursed by it that are otherwise your obligation to pay under the AAA Rules. Except as otherwise provided for, LG waives any rights it may have to seek attorneys’ fees and expenses from you if LG prevails in the arbitration.

Hearings and Location. If your claim is for \$25,000 or less, you may choose to have the arbitration conducted solely on the basis of (1) documents submitted to the arbitrator, (2) through a telephonic hearing, or (3) by an in-person hearing as established by the AAA Rules. If your claim exceeds \$25,000, the right to a hearing will be determined by the AAA Rules. Any in-person arbitration hearings will be held at a location within the federal judicial district in which you reside unless we both agree to another location or we agree to a telephonic arbitration.

Opt Out. You may opt out of this dispute resolution procedure. If you opt out, neither you nor LG can require the other to participate in an arbitration proceeding. To opt out, you must send notice to LG no later than 30 calendar days from the date of the first consumer purchaser’s purchase of the product by either: (i) sending an e-mail to optout@lge.com, with the subject line: “Arbitration Opt Out” or (ii) calling 1-800-980-2973. You must include in the opt out e-mail or provide by telephone: (a) your name and address; (b) the date on which the product was purchased; (c) the product model name or model number; and (d) the serial number (the serial number can be found (i) on the product; or (ii) online by accessing <https://www.lg.com/us/support/repair-service/schedule-repair-continued> and clicking on “Find My Model & Serial Number”).

You may only opt out of the dispute resolution procedure in the manner described above (that is, by e-mail or telephone); no other form of notice will be effective to opt out of this dispute resolution procedure. Opting out of this dispute resolution procedure will not affect the coverage of the Limited Warranty in any way, and you will continue to enjoy the full benefits of the Limited Warranty. If you keep this product and do not opt out, then you accept all terms and conditions of the arbitration provision described above.

LIMITED WARRANTY (CANADA)

ARBITRATION NOTICE: THIS LIMITED WARRANTY CONTAINS AN ARBITRATION PROVISION THAT REQUIRES YOU AND LG TO RESOLVE DISPUTES BY BINDING ARBITRATION INSTEAD OF IN COURT, UNLESS THE LAWS OF YOUR PROVINCE OR TERRITORY DO NOT PERMIT THAT, OR, IN OTHER JURISDICTIONS, IF YOU CHOOSE TO OPT OUT. IN ARBITRATION, CLASS ACTIONS AND JURY TRIALS ARE NOT PERMITTED. PLEASE SEE THE SECTION TITLED "PROCEDURE FOR RESOLVING DISPUTES" BELOW.

WARRANTY:

Should your LG Washer ("Product") fail due to a defect in material or workmanship under normal home use during the warranty period set forth below, LG Canada will at its option repair or the Product upon receipt of proof of original retail purchase. This warranty is valid only to the original retail purchaser of the product and applies only to a Product distributed in Canada by LG Canada or an authorized Canadian distributor thereof. The warranty only applies to Products located and used within Canada. Coverage for "in Home" repairs, for products in-warranty, will be provided if the Product is within a 150 km radius from the nearest authorized service center (ASC), as determined by LG Canada. If your Product is located outside a 150 km radius from a ASC, as determined by LG Canada, it will be your responsibility to bring the Product, at your sole expense, to the ASC for in-warranty repair.

WARRANTY PERIOD : (Note : If the original date of purchase can not be verified, the warranty will begin sixty(60) days from the date of manufacture).			
Period	One (1) year from the date of original retail purchase	Ten (10) years from the date of original retail purchase	Five (5) years from the date of original retail purchase
Scope of Warranty	Parts and Labor (internal/functional parts only)	DD Motor (Stator, Rotor)	Stainless Steel Drum
Remark	LG will provide parts & labor to repair or replace defective parts.	Extended Component Warranty (Parts Only) (Consumer will be charged for Labor after one (1) year from the date of purchase)	

- Replacement products and parts are replaced for the remaining portion of the original warranty period or ninety (90) days, whichever is greater.
- Replacement products and parts may be new or remanufactured.
- Proof of original retail purchase specifying the Product model and date of purchase is required to obtain warranty service under this Limited Warranty.

LG Canada's sole liability is limited to the warranty set out above. Except as expressly provided above, LG Canada makes no and hereby disclaims all other warranties and conditions respecting the product, whether express or implied, including, but not limited to, any implied warranty or condition of merchantability or fitness for a particular purpose, and no representations shall be binding on LG Canada. LG Canada does not authorize any person to create or assume for it any other warranty obligation or liability in connection with the product. To the extent that any warranty or condition is implied by law, it is limited to the express warranty period above. LG Canada, the manufacturer or distributor shall not be liable for any incidental, consequential, special, direct or indirect damages, loss of goodwill, lost profits, punitive or exemplary damages or any other damage, whether arising Directly or indirectly from any contractual breach, fundamental or otherwise, or from any acts or omissions, tort, or otherwise. This warranty gives you specific legal rights. You may have other rights which may vary from province to province depending on applicable provincial laws.

Any term of this warranty that negates or varies any implied condition or warranty under provincial law is severable where it conflicts with provincial law without affecting the remainder of this warranty's terms.

This limited warranty does not cover:

1. Service trips to deliver, pick up, or install the product; instructing a customer on operation of the product; repair or replacement of fuses or correction of wiring, or correction of unauthorized repairs/installation.
2. Failure of the product to perform during power failures and interruptions or inadequate electrical service.
3. Damage caused by leaky or broken water pipes, frozen water pipes, restricted drain lines, inadequate or interrupted water supply or inadequate supply of air.
4. Damage resulting from operating the Product in a corrosive atmosphere or contrary to the instructions outlined in the Product owner's manual.
5. Damage to the Product caused by accidents, pests and vermin, lightning, wind, fire, floods, or acts of God.
6. Damage resulting from the misuse, abuse, improper installation, repair, or maintenance of the Product. Improper repair includes use of parts not approved or specified by LG Canada.
7. Damage or product failure caused by unauthorized modification or alteration, or use for other than its intended purpose, or resulting from any water leakage due to improper installation.
8. Damage or Product failure caused by incorrect electrical current, voltage, commercial or industrial use, or use of accessories, components, or cleaning products that are not approved by LG Canada.
9. Damage caused by transportation and handling, including scratches, dents, chips, and/or other damage to the finish of your product, unless such damage results from defects in materials or workmanship and is reported within one (1) week of delivery.
10. Damage or missing items to any display, open box, discounted, or refurbished Product.
11. Products with original serial numbers that have been removed, altered, or cannot be readily determined. Model and Serial numbers, along with original retail sales receipt, are required for warranty validation.
12. Increases in utility costs and additional utility expenses.
13. Replacement of light bulbs, filters, or any consumable parts.
14. Repairs when your Product is used in other than normal and usual household use (including, without limitation, commercial use, in offices or recreational facilities) or contrary to the instructions outlined in the Product owner's manual.
15. Costs associated with removal of the Product from your home for repairs.
16. The removal and reinstallation of the Product if it is installed in an inaccessible location or is not installed in accordance with published installation instructions, including the Product owner's and installation manuals.
17. Accessories to the Product such as door bins, drawers, handles, shelves, etc. Also excluded are parts besides those that were originally included with the Product.

All costs associated with the above excluded circumstances shall be borne by the consumer.

For complete warranty details and customer assistance, please call or visit our website:

Write your warranty information below:

Call 1-888-542-2623 (7 A.M to 12 A.M., 365 days a year) and select the appropriate option from the menu, or visit our website at <http://www.lg.com>

Product Registration Information:
Model:
Serial Number:
Date of Purchase:

PROCEDURE FOR RESOLVING DISPUTES:

EXCEPT WHERE PROHIBITED AT LAW, ALL DISPUTES BETWEEN YOU AND LG ARISING OUT OF OR RELATING IN ANY WAY TO THIS LIMITED WARRANTY OR THE PRODUCT SHALL BE RESOLVED EXCLUSIVELY THROUGH BINDING ARBITRATION, AND NOT IN A COURT OF GENERAL JURISDICTION. EXCEPT WHERE PROHIBITED AT LAW, YOU AND LG BOTH IRREVOCABLY AGREE TO WAIVE THE RIGHT TO A JURY TRIAL AND TO BRING OR PARTICIPATE IN A CLASS ACTION.

Definitions. For the purposes of this section, references to “LG” mean LG Electronics Canada, Inc., its parents, subsidiaries and affiliates, and each of their officers, directors, employees, agents, beneficiaries, predecessors in interest, successors, assigns and suppliers; references to “dispute” or “claim” shall include any dispute, claim or controversy of any kind whatsoever (whether based in contract, tort, statute, regulation, ordinance, fraud, misrepresentation or any other legal or equitable theory) arising out of or relating in any way to the sale, condition or performance of the product or this Limited Warranty.

Notice of Dispute. In the event you intend to commence an arbitration proceeding, you must first notify LG in writing at least 30 days in advance of initiating the arbitration by sending a letter to LGECI Legal Team at 20 Norelco Drive, North York, Ontario, Canada M9L 2X6 (the “Notice of Dispute”). You and LG agree to engage in good faith discussions in an attempt to amicably resolve your claim. The notice must provide your name, address, and telephone number; identify the product that is the subject of the claim; and describe the nature of the claim and the relief being sought. If you and LG are unable to resolve the dispute within 30 days of LG’s receipt of the Notice of Dispute, the dispute shall be resolved by binding arbitration in accordance with the procedure set out herein. You and LG both agree that, during the arbitration proceeding, the terms (including any amount) of any settlement offer made by either you or LG will not be disclosed to the arbitrator until the arbitrator determines the dispute.

Agreement to Binding Arbitration and Class Action Waiver. Upon failure to resolve the dispute during the 30 day period after LG’s receipt of the Notice of Dispute, you and LG agree to resolve any claims between you and LG only by binding arbitration on an individual basis, unless you opt out as provided below, or you reside in a jurisdiction that prevents full application of this clause in the circumstances of the claims at issue (in which case if you are a consumer, this clause will only apply if you expressly agree to the arbitration). To the extent permitted by applicable law, any dispute between you and LG shall not be combined or consolidated with a dispute involving any other person’s or entity’s product or claim. More specifically, without limitation of the foregoing, except to the extent such a prohibition is not permitted at law, any dispute between you and LG shall not under any circumstances proceed as part of a class or representative action. Instead of arbitration, either party may bring an individual action in small claims court, but that small claims court action may not be brought on a class or representative basis except to the extent this prohibition is not permitted at law in your province or territory of jurisdiction as it relates to the claims at issue between you and LG.

Arbitration Rules and Procedures. To begin arbitration of a claim, either you or LG must make a written demand for arbitration. The arbitration will be private and confidential, and conducted on a simplified and expedited basis before a single arbitrator chosen by the parties under the provincial or territorial commercial arbitration law and rules of the province or territory of your residence. You must also send a copy of your written demand to LG at LG Electronics, Canada, Inc., Attn: Legal Department- Arbitration, 20 Norelco Drive, North York, Ontario M9L 2X6. This arbitration provision is governed by your applicable provincial or territorial commercial arbitration legislation. Judgment may be entered on the arbitrator’s award in any court of competent jurisdiction. All issues are for the arbitrator to decide, except that, issues relating to the scope and enforceability of the arbitration provision and to the arbitrability of the dispute are for the court to decide. The arbitrator is bound by the terms of this provision.

Governing Law. The law of the province or territory of your purchase shall govern this Limited Warranty and any disputes between you and LG except to the extent that such law is preempted by or inconsistent with applicable federal or provincial/territorial law. Should arbitration not be permitted for any claim, action, dispute or controversy between you and LG, you and LG attorn to the exclusive jurisdiction of the courts of the province or territory of your purchase for the resolution of the claim, action, dispute or controversy between you and LG.

Fees/Costs. You do not need to pay any fee to begin an arbitration. Upon receipt of your written demand for arbitration, LG will promptly pay all arbitration filing fees unless you seek more than \$25,000 in damages, in which case the payment of these fees will be governed by the applicable arbitration rules. Except as otherwise provided for herein, LG will pay all filing, administration and arbitrator fees for any arbitration initiated in accordance with the applicable arbitration rules and this arbitration provision. If you prevail in the arbitration, LG will pay your attorneys’ fees and expenses as long as they are reasonable, by considering factors including, but not limited to, the purchase amount and claim amount. Notwithstanding the foregoing, if applicable law allows for an award of reasonable attorneys’ fees and expenses, an arbitrator can award them to the same extent that a court would. If the arbitrator finds either the substance of your claim or the relief sought in the demand is frivolous or brought for an improper purpose (as measured by the applicable laws), then the payment of all arbitration fees will be governed by the applicable arbitration rules. In such a situation, you agree to reimburse LG for all monies previously disbursed by it that are otherwise your obligation to pay under the applicable arbitration rules. Except as otherwise provided for, LG waives any rights it may have to seek attorneys’ fees and expenses from you if LG prevails in the arbitration.

Hearings and Location. If your claim is for \$25,000 or less, you may choose to have the arbitration conducted solely (1) on the basis of documents submitted to the arbitrator, (2) through a telephonic hearing, or (3) by an in-person hearing as established by the applicable arbitration rules. If your claim exceeds \$25,000, the right to a hearing will be determined by the applicable arbitration rules. Any in-person arbitration hearings will be held at the nearest, most mutually-convenient arbitration location available within the province or territory in which you reside unless you and LG both agree to another location or agree to a telephonic arbitration.

Severability and Waiver. If any portion of this Limited Warranty (including these arbitration procedures) is unenforceable, the remaining provisions will continue in full force and effect to the maximum extent permitted by applicable law. Should LG fail to enforce strict performance of any provision of this Limited Warranty (including these arbitration procedures), it does not mean that LG intends to waive or has waived any provision or part of this Limited Warranty.

Opt Out. You may opt out of this dispute resolution procedure. If you opt out, neither you nor LG can require the other to participate in an arbitration proceeding. To opt out, you must send notice to LG no later than 30 calendar days from the date of the first consumer purchaser's purchase of the product by either (i) sending an e-mail to optout@lge.com, with the subject line: "Arbitration Opt Out;" or (ii) calling 1-800-980-2973. You must include in the opt out e-mail or provide by telephone: (a) your name and address; (b) the date on which the product was purchased; (c) the product model name or model number; and (d) the serial number (the serial number can be found (i) on the product; or (ii) online by accessing https://www.lg.com/ca_en/support/repair-service/schedule-repair and clicking on "Find My Model & Serial Number").











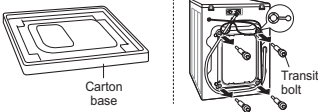

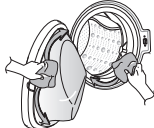

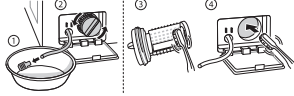

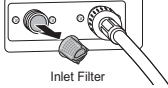

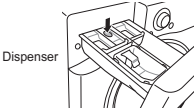
In the event that you "Opt Out", the law of the province or territory of your residence shall govern this Limited Warranty and any disputes between you and LG except to the extent that such law is preempted by or inconsistent with applicable federal or provincial/territorial law. Should arbitration not be permitted for any claim, action, dispute or controversy between you and LG, you and LG agree to attorn to the exclusive jurisdiction of the courts of the province or territory of your residence for the resolution of the claim, action, dispute or controversy between you and LG.

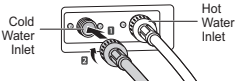
You may only opt out of the dispute resolution procedure in the manner described above (that is, by e-mail or telephone); no other form of notice will be effective to opt out of this dispute resolution procedure. Opting out of this dispute resolution procedure will not affect the coverage of the Limited Warranty in any way, and you will continue to enjoy the full benefits of the Limited Warranty. If you keep this product and do not opt out, then you accept all terms and conditions of the arbitration provision described above.

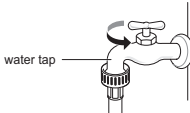
Conflict of Terms. In the event of a conflict or inconsistency between the terms of this Limited Warranty and the End User License Agreement ("EULA") in regards to dispute resolution, the terms of this Limited Warranty shall control and govern the rights and obligations of the parties and shall take precedence over the EULA.

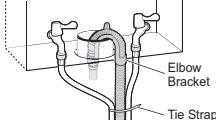
THIS LIMITED WARRANTY DOES NOT COVER THE FOLLOWING CASES

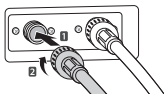
With regard to damages or failures resulting from misuse, improper installation, maintenance, natural disaster or repair (unauthorized technician or parts, as specified by LG), customer will be charged for the repair.

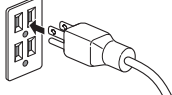
<p>Strange vibration or noise caused by not removing transit bolts or tub support.</p>		 <p>Carton base Transit bolt</p>	<p>Remove the transit bolts & tub support.</p>
<p>Leakage caused by dirt (hair, lint) on gasket and door glass.</p>			<p>Clean the gasket & door glass.</p>
<p>Not draining caused by clogging of pump filter.</p>			<p>Clean the pump filter.</p>
<p>Water is not filling properly because water inlet valve filters are clogged or water inlet hoses are kinked.</p>		 <p>Inlet Filter</p>	<p>Clean the inlet valve filter or reinstall the water inlet hoses.</p>
<p>Water is not filling properly because too much detergent use.</p>		 <p>Dispenser</p>	<p>Clean the detergent disperser drawer.</p>
<p>Laundry is hot or warm after finished washing because the inlet hoses are installed in reverse.</p>		 <p>Cold Water Inlet Hot Water Inlet</p>	<p>Reinstall the inlet hoses.</p>
<p>Water is not supplied because the water tap is not turned on.</p>		 <p>water tap</p>	<p>Turn on the water tap.</p>
<p>Leakage caused by improper installation of drain hose or clogged drain hose.</p>		 <p>Elbow Bracket Tie Strap</p>	<p>Reinstall the drain hose.</p>
<p>Leakage caused by improper installation of water inlet hose or using other brand inlet hoses.</p>			<p>Reinstall the inlet hose.</p>
<p>Lack of power caused by loose connection of power cord or electrical outlet problem.</p>			<p>Reconnect the power cord or change the electrical outlet.</p>

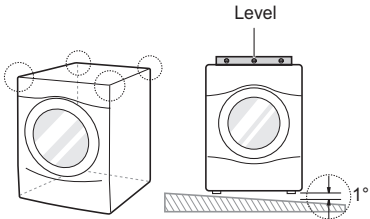
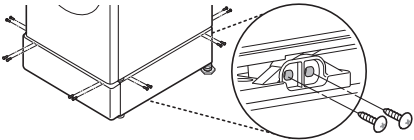
<p>Service trips to deliver, pick up, install the product or for instruction on product use. The removal and reinstallation of the Product.</p>	➔	 <p>Level</p>	<p>The warranty covers manufacturing defects only. Service resulting from improper Installation is not covered.</p>
<p>If all screws are not installed properly, it may cause excessive vibration (Pedestal model only).</p>	➔		<p>Install 4 screws at each corner (Total 16EA).</p>



LG Customer Information Center

For inquiries or comments,
visit www.lg.com or call:

1-800-243-0000 U.S.A.
1-888-542-2623 CANADA

Register your product Online!

www.lg.com