

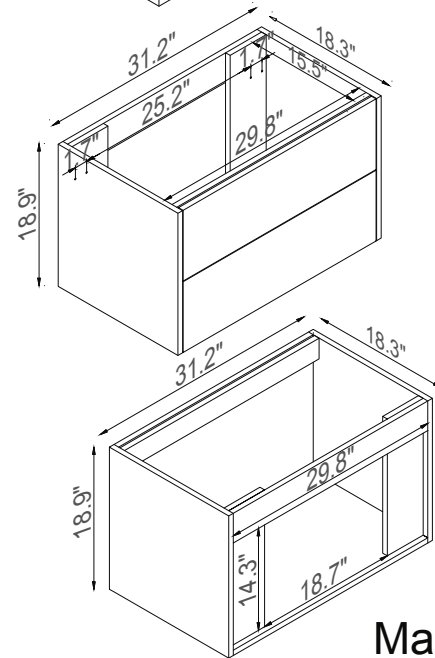

Streamline

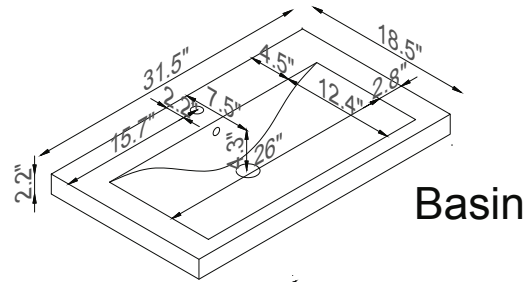

K1500-098-32-51