

Reverse Osmosis System

Installation Manual



Customer Support 1-800-992-8876





Reverse Osmosis

Overall System Connections

Your drinking water is going to be healthier and taste better from now on, and nothing makes us happier. Getting started is a breeze— most of your Reverse Osmosis System is already assembled and every connection is color coded. We've marked where the colored tubes will go with matching colored plugs in each fitting.

We know life isn't always so simple though. If you have questions during your setup we can help. Just give us a call during normal business hours at: **1-800-992-8876**

Connection Points

A to B Connect the RED Tubing to the Feed Water Adapter Valve (point A), then to the hole marked "IN" on the Leak Stop Valve (point B).

C to D Connect the WHITE Tubing to the hole marked "OUT" on the Leak Stop Valve (point C), then to the Sediment Filter Housing's Male Elbow Fitting (point D).

E to F Connect the BLACK Tubing to the Flow Restrictor side indicated by the arrow on the Restrictor (point E), then to the Drain Saddle (point F).

G to H Connect the YELLOW Tubing to the Inline Post Carbon Filter's Stem Run Tee (point G), then to the Water Storage Tank's Tank Valve (point H).

I to J Connect the BLUE Tubing to the Stem Elbow at the end of the Inline Post Carbon Filter (point I), then to your RO Faucet connection (point J).



For Installation Videos go to:
www.youtube.com/c/ExpressWaterVideo



Kitchen Faucet



RO Faucet

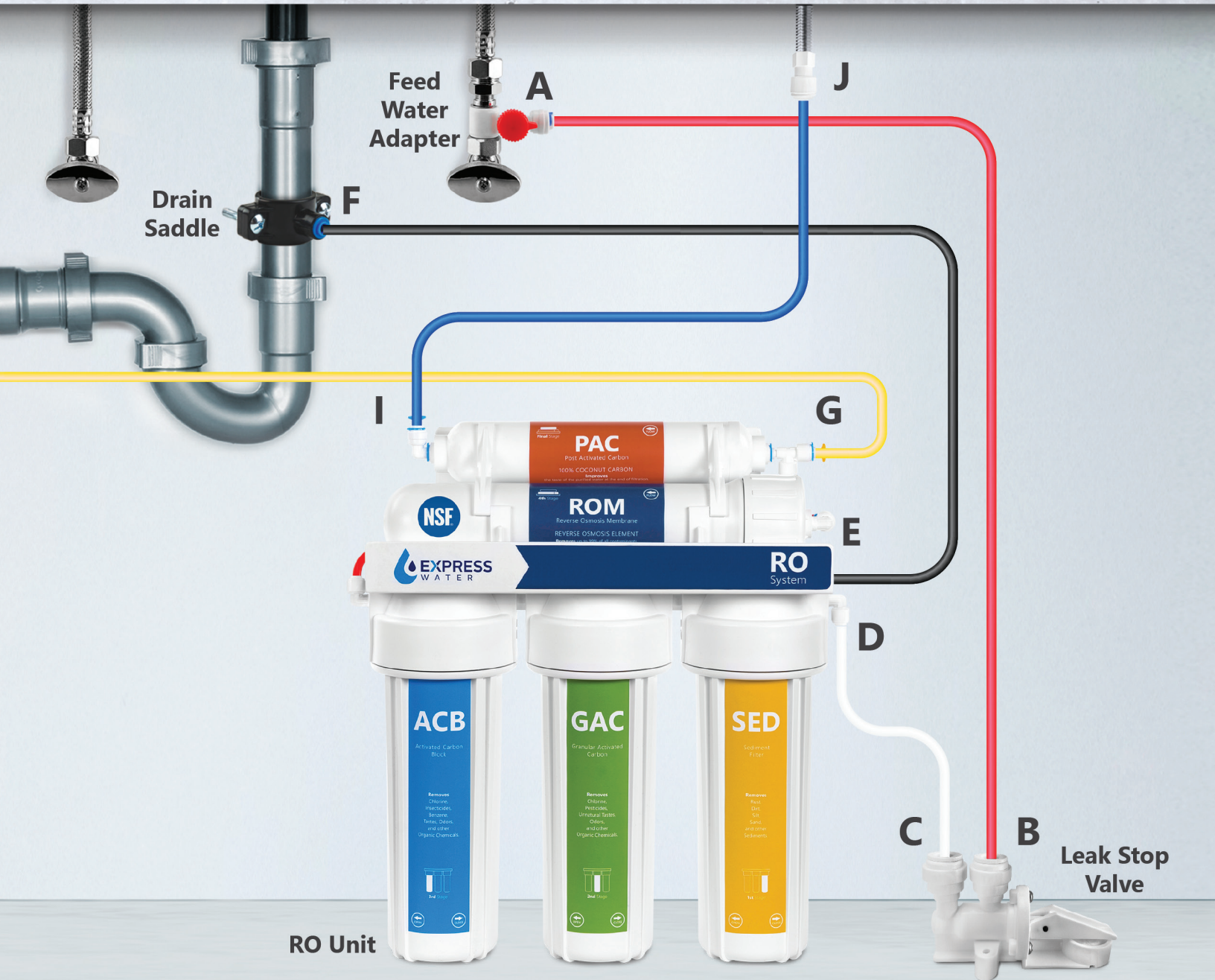

RO Unit

Leak Stop Valve

Performance Data Sheet

Express Water Systems Reverse Osmosis Water Filtration System Performance Data					
Model	Operating Pressure	Operating Temperature	Recovery Rating	Efficiency Rating	Daily Production
RO5DX	50-100 PSI 344-689 kPa	40-100° F 5-38° C	16.17%	17.44%	12.22 GPD
RO10DX	50-100 PSI 344-689 kPa	40-100° F 5-38° C	17.10%	9.66%	21.89 GPD

Express Water - 12730 Raymer St, Unit 1, North Hollywood, CA 91605

Express Water RO5DX and RO10DX have been tested according to NSF/ANSI 58 for reduction of the substances listed below. The concentration of the indicated substances in water entering the system was reduced to a concentration less than or equal to the permissible limit for water leaving the system, as specified in NSF/ANSI 58.

NSF/ANSI 58 Substance	Avg. Inf. mg/L	Avg. Eff. mg/L	% Reduction	Max. Eff. mg/L	Inf. Challenge Concentration mg/L	Max. Permissible Concentration mg/L
TDS (Model RO5DX)	770	36	95.40%	47.00	750 ±40 mg/L	187
TDS (Model RO10DX)	770	36	95.40%	43.00	750 ±40 mg/L	187

- Do not use this system with water that is microbiologically unsafe or of unknown quality without adequate disinfection before or after the system.
- Testing was performed under standard laboratory conditions, actual performance may vary.
- See owner's manual for general installation/operation/maintenance conditions and needs as well as manufacturer's limited product warranty.
- Efficiency rating means the percentage of the influent water to the system that is available to the user as reverse osmosis treated water under operating conditions that approximate typical daily usage.
- Recovery rating means the percentage of the influent water to the membrane portion of the system that is available to the user as reverse osmosis treated water when the system is operated without a storage tank or when the storage tank is bypassed.



Tested and Certified by NSF International against NSF/ANSI 58 in Model RO5DX and RO10DX for TDS Reduction.

Conditions

READ THIS FIRST

Please pay attention to the following installation and safety recommendations:

- Read the installation manual before installing this system.

NOTE! Please make sure your installation location has enough room for the RO System and Water Storage Tank

Incoming Water

Incoming water pressure must be between 40 PSI and 80 PSI. If your water pressure is under 40 PSI you will need a booster pump for your system. If your water pressure is above 80 PSI you will need a pressure regulator for your system. Test your water pressure occasionally to make sure the system is performing. If your water is microbiologically unsafe or of unknown quality do not use this system without adequate disinfection before or after the system. Extremely hot or cold incoming water will damage the system and cannot be used.

Leaks

The Leak Stop Valve must be installed. Inspect all connections after the installation to make sure no leaks occur, wait until after the system is pressurized (turned on) to inspect again. Check system occasionally after installation or maintenance to make sure no leaks have developed. Install the system in a location with adequate drainage.

General

This RO System unit is for climate controlled indoor use only. Exposure to overly high or low temperature ranges will damage the unit. Follow all of your state and local laws and codes regarding plumbing even if they differ from what is stated in this manual. If your state law requires it or you prefer to we recommend using a professional licensed installer or plumber who meets the requirements of this system. All O-Rings, fittings, filter canisters, and teflon tape wear out after a certain period of time. The lifetime of your components are subject to change with the quality of the water supplied. Do not handle an unwrapped filter directly with your bare hands as this can cause early filter failure. Use appropriate eye and face protection when performing any drilling.

Maintenance

The owner/user is obligated to properly maintain the RO System when necessary, at least every 1 year. This includes the following:

- Replace the O-rings on the filter housings, membrane housing, fittings, and filter cartridges.
- Replace any connectors and filter housings with proper replacement parts.
- Sanitize your system as often as needed (how often changes with the profile of your area's incoming water).
- Always use proper replacement filter cartridges with the correct size and length replacements.
- Replace the Teflon Tape on all threaded connections and fittings.

Copyright © 2020 by Express Water Inc.

All rights reserved. No part of this publication may be reproduced, distributed, or transmitted in any form or by any means, including photocopying, recording, or other electronic or mechanical methods, without the prior written permission of the publisher, except in the case of brief quotations embodied in critical reviews and certain other noncommercial uses permitted by copyright law.

Table of Contents

Introduction	Page 9
Installation Notes	Page 10
Components List	Page 10
System Components	Page 12
Tubing Quick Connect Guide	Page 13

Installation

Feed Water Adapter Valve	Page 14
RO Faucet	Page 16
Drain Saddle	Page 18
Housing Assembly	Page 19
Elbow Fitting Installation	Page 20
Gauge Installation	Page 20
Leak Stop Valve	Page 21
Water Storage Tank	Page 22
System Connections	Page 23

System Startup	Page 24
-----------------------	---------

System Maintenance	Page 24
Filter Change Instruction	Page 25
How to Sanitize your RO Drinking Water System	Page 26
Troubleshooting	Page 27

FAQ	Page 28
Express Water Accessories and Upgrades	Page 30
Warranty	Page 31

Introduction





You have purchased the finest residential **Reverse Osmosis Drinking Water System** available for your home. When properly maintained this system will provide you with years of great tasting pure drinking water and trouble-free service.

Please make sure to thoroughly read the installation manual and become familiar with the tools needed before proceeding with the installation.

Also, please make sure to inspect the package for any missing components or shipping damages.

If you find any issues or have questions please contact **Express Water at 1-800-992-8876 Monday - Friday 10 am to 5 pm PST**

Replacements Table

Cartridge Filters	Model	Service Life
Stage 1 5 Micron Sediment Filter 	FLTSED0501	6 Months
Stage 2 GAC Filter 	FLTGAC0501	6 Months
Stage 3 Carbon Block Filter 	FLTCAR0501C	6 Months
Stage 4 RO Membrane 	FLTMEME50 (50 GPD Membrane) FLTMEME100 (100 GPD Membrane)	1 - 2 Years
Stage 5 Inline Post Carbon Filter 	FLTIN01PKQ	1 Year

Replacement Filters

Express Water offers replacement filters for both the **RO5DX (50GPD System)** and **RO10DX (100GPD System)** Reverse Osmosis Water Filtration Systems. For purchasing information for replacement filters, please visit our website at www.ExpressWater.com

Installation Notes

Tools Required

Before you begin please make sure you have all of the following tools ready to use:

- Box Cutter
- Phillips-Head Screwdriver
- Power Drill
- 1/4" Drill Bit (*for Drain Saddle Valve*)
- 1/2" Drill Bit (*for RO Faucet*)
- Adjustable Wrench

Components List

Your new Reverse Osmosis Water System should include the following items.
If any item is missing please contact Express Water.

Please take a few moments to check all the following components:

Accessories and Connections

Color Coded Tube 1/4" OD

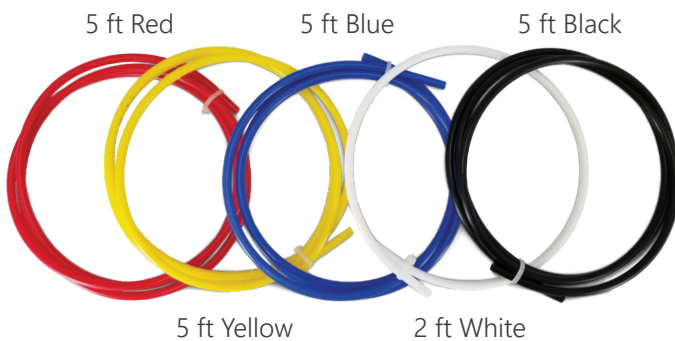

Drain Saddle Package



Connections

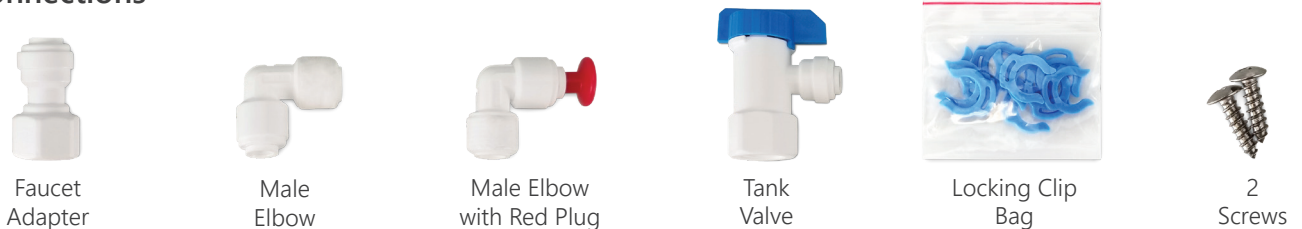

Feed Water Adapter Valve



Teflon Tape



Filter Housing Wrench

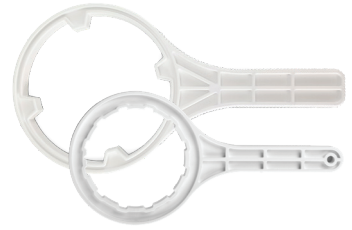

Leak Stop Valve Components

- Leak Stop Valve
- 3 Replacement Pads
- 2 Mounting Screws



RO Storage Tank

- Water Storage Tank
- Tank Stand

NOTE!

In the package you will find the Tank Stand screwed to the top of the tank. Unscrew it and place it underneath for a steady position.



RO Faucet Kit Components



Faucet Design and Accessories May Vary

1. Rubber Washer (Large)
2. Base Plate
3. Plastic Washer
4. Rubber Washer (Small)
5. Lock Washer
6. Hex Nut
7. Compression Nut
8. Insert
9. Sleeve

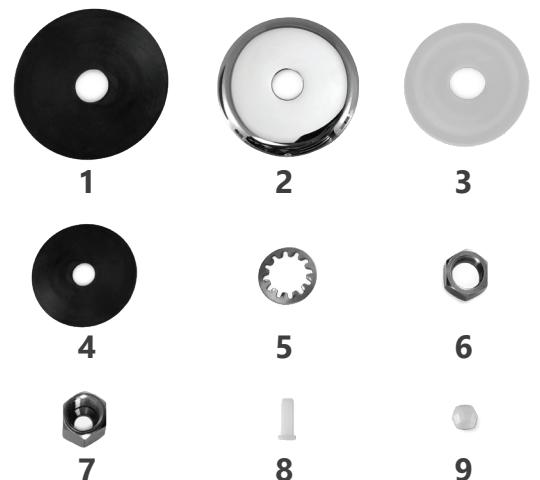

RO Unit

Top Components

Inline Post Carbon Filter - FLTIN01PKQ

RO Membrane Filter - FLTMEME50 / FLTMEME100

Bottom Components

Filter Housings - PRTHSF10DB14

Sediment Filter - FLTSED0501

GAC Filter - FLTGAC0501

Carbon Block Filter - FLTCAR0501C

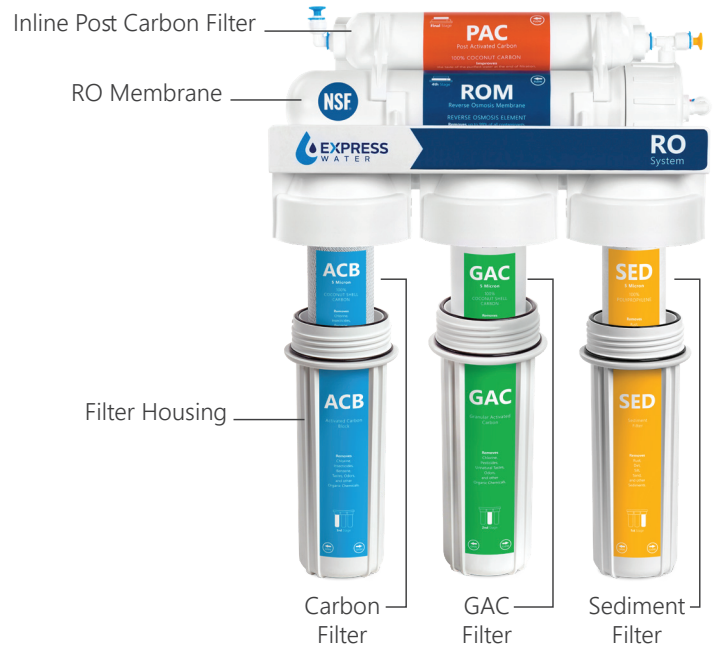

System Components

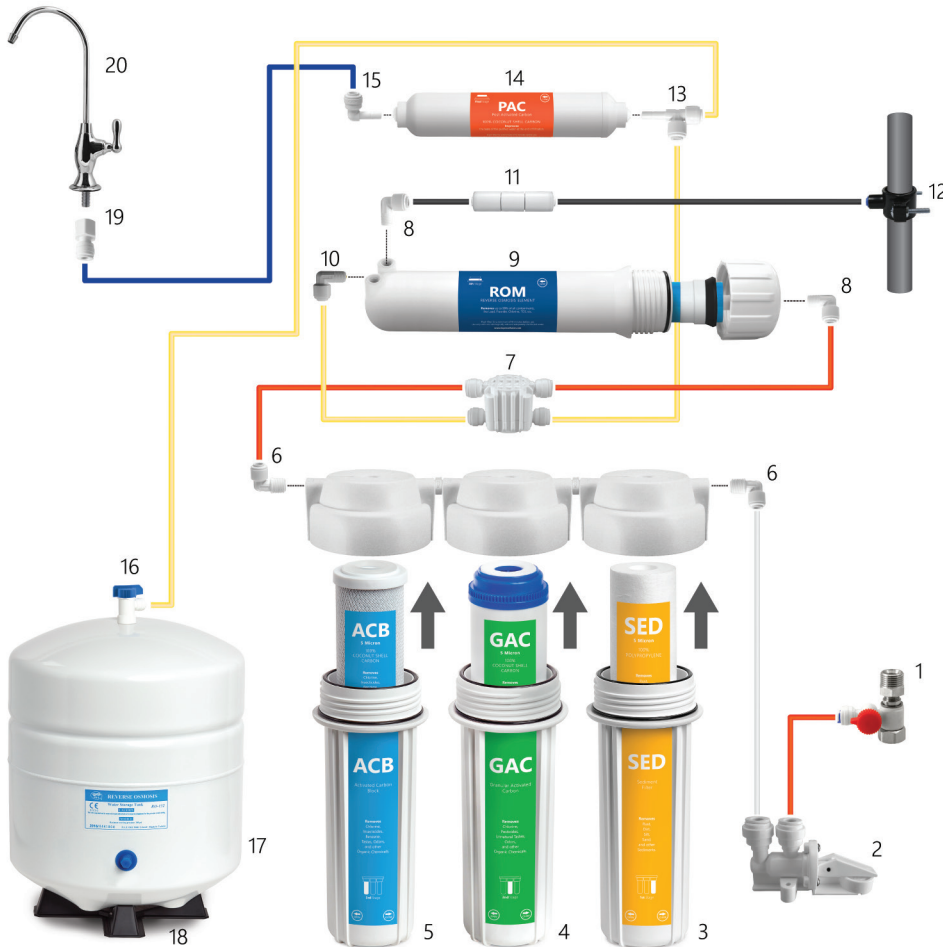

1. Feed Water Adapter Valve
2. Leak Stop Valve
3. Sediment Filter
4. GAC Filter
5. Carbon Block Filter
6. Male Elbow Fitting
7. Automatic Shut-Off Valve
8. Male Elbow 1/8"
9. RO Membrane Housing
10. Check Valve
11. Flow Restrictor
12. Drain Saddle
13. Stem Run Tee
14. Inline Post Carbon Filter
15. Stem Elbow
16. Tank Valve
17. Water Storage Tank
18. Tank Stand
19. Faucet Adapter
20. RO Faucet

Tubing Quick Connect Guide

The tubing in your RO System uses a Quick Connect locking mechanism to lock the Color Coded Tubing in place. Be careful not to damage your tubing as you unpack it.

NOTE!

Make sure to remove any plugs before attempting to insert tubing.

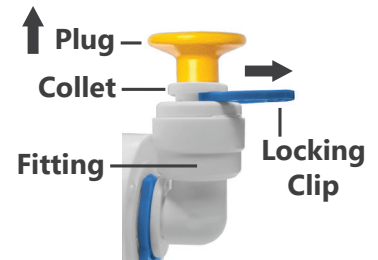

Release Tubing/Plugs

If there is a Locking Clip on the Collet it must be removed before the Tubing can be released. Push and hold the Collet in to release the lock while pulling out on the Tube/Plug.

NOTE! Collet must be held down while pulling up on the tube to release the tube.

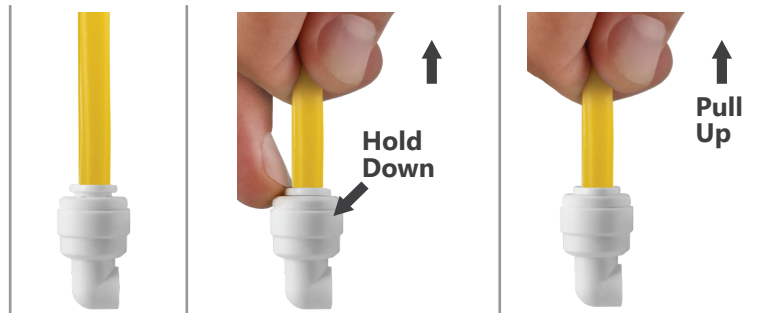

Insert or Remove Locking Clips

To lock a Tube in place make sure the Tubing is fully inserted then slide the open end of the Clip between the Collet and Fitting. The Clip must be removed before the Tubing can be removed. To remove the Clip pull away until it slides out from between the Collet and Fitting.

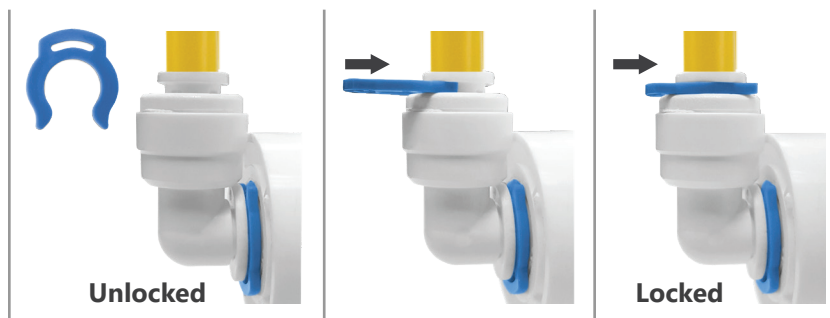

Attach Tubing

Push Tubing in straight and level with the Collet. The Tubing will go 5/8ths of an inch into the Collet before the lock is activated. Pull out on the Tube to make sure the lock has activated and the Tubing is secure.

NOTE! Once connected, make sure to check tubing is secure.



To Cut Tubing

Make your cuts against a flat cutting surface with a razor blade, or use a handheld tube cutter. Any cuts to your Tubing must be perfectly straight.

NOTE!

Improperly cut Tubing may leak water or fail to lock into Fittings.

Wait until all elements of your RO System are in their final locations before cutting your Tubing. Make sure you measure the length you will need before cutting.

Feed Water Adapter Valve

CAUTION!

The water supply to the unit **MUST** be from the **COLD WATER LINE**. Using **HOT WATER** will severely damage your RO System.

NOTE!

If your Cold Water Valve is too old or weak to connect to directly **Option A** you can connect at the top of the line where the faucet connects **Option B** (if applicable, some sinks do not have this connection point).

1. Locate the Cold Water Valve underneath the sink and turn it off completely. Next, open the cold water handle on your sink to release pressure by expelling any existing water. Check to make sure the water has stopped flowing completely before proceeding.

Do Not Connect To Hot Water Line!

NOTE!

On single-handle faucets the hot water may have to be turned off to prevent hot water crossover (only during your first installation).

If water still continues to come out of the faucet with the Cold Water Valve turned off, then the main water supply must be turned off as well.

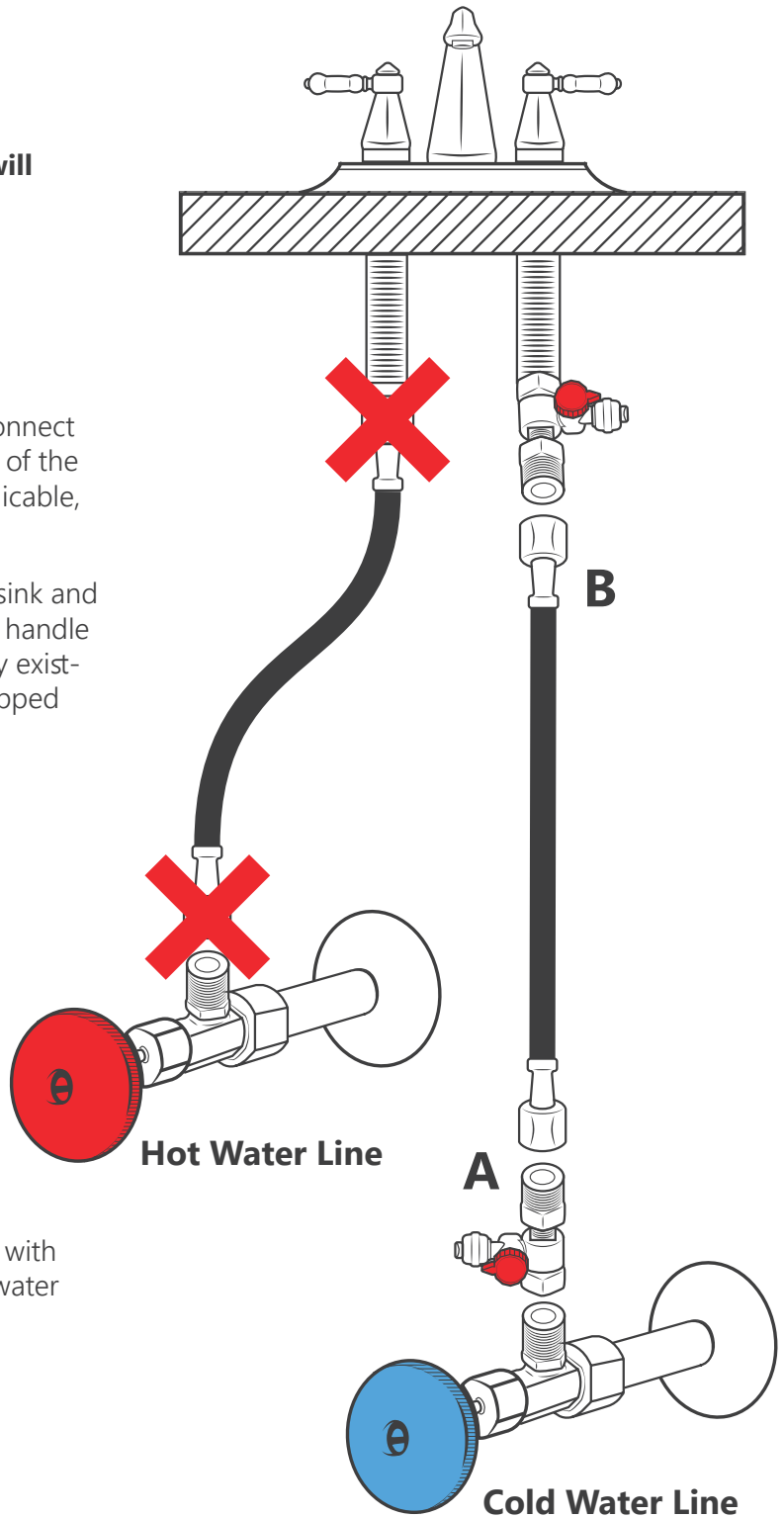

2. As shown below, the Feed Water Adapter Valve can be used for 3/8" or 1/2" feed line plumbing.

1/2" Connection

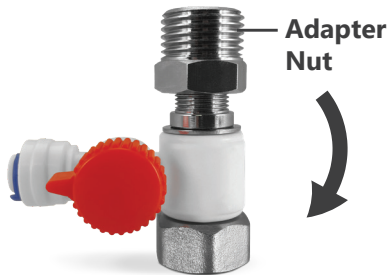

Simply switch the Adapter Nut from one side of the Adapter Valve to the other.



3/8" Connection



Next, use an adjustable wrench to secure the Adapter Valve either directly to the Cold Water Valve **Option A** or further up in the line before the faucet **Option B** (if applicable).

Make sure your Adapter Valve is in the closed position when installing.

NOTE!

Do Not Use Teflon Tape!

Use your wrench to tighten the connection, be careful not to over tighten.



OPEN



CLOSED

WARNING!

INCOMING WATER PRESSURE SHOULD NOT EXCEED 80 PSI

Using the Feed Water Adapter Valve

During installation leave your Feed Water Adapter Valve in the "CLOSED" position until System Startup. The Feed Water Adapter Valve controls all water coming into your RO System. If for any reason you need to stop incoming water turn the Feed Water Adapter Valve to the "CLOSED" position. Always turn this valve off before replacing filters, if a leak is discovered, or when shutting down the system.

RO Faucet

The RO Faucet may be installed on any flat surface. Check the underside of your install location for interference by making sure that drilling a hole will not damage any pipes or wiring underneath the countertop or sink. Check to be sure there is enough room for the Threaded Faucet Stem.

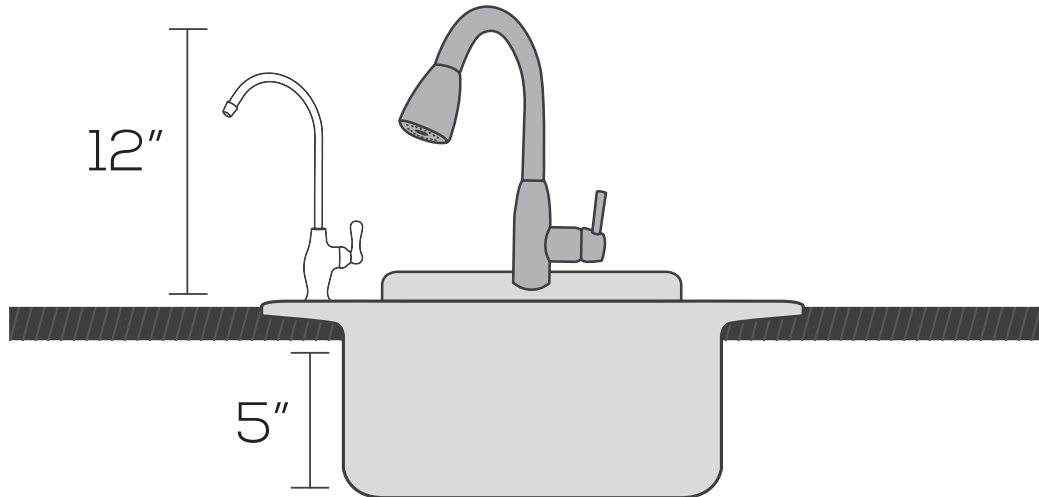

NOTE! For drilling you must use an appropriate drill bit and drilling method for the material of your sink and counter top. Different drill bits are required for stainless steel, porcelain, granite, etc.

You may use an existing hole in your counter or sink or drill a new hole (if using an existing hole begin at step 2). Make sure the Base Plate is big enough to cover the hole you use.

Porcelain Sink

A proper porcelain 1/2" drill bit is strongly recommended to prevent chipping if you are drilling on a porcelain sink. Drill slowly to avoid chipping during the initial cutting of the porcelain.

Stainless Steel Sink

1. Use a proper 1/2" drill bit (depending on your counter material) to make a hole for your RO Faucet.
2. Insert the small rubber washer, then the base plate, then the large rubber washer (see image on next page) onto the Threaded Faucet Stem at the base of the RO Faucet. Then put the Threaded Faucet Stem through the newly drilled or pre-existing hole. Make sure the RO Faucet sits in the center of the hole.
3. Under the sink install the Plastic Washer, Lock Washer, and Hex Nut (see image on next page) onto the Threaded Faucet Stem. Make sure they are installed all the way up the stem.

NOTE! You can use either connection type A or B.

4. Faucet Connection Line

(Refer to connection images on next page)

Connection Type A - Add the Compression Nut, with the more open end facing outwards, and Sleeve (see image) to the Blue Tubing near one of the ends. Add the Insert into the opening at the same end of the Tubing, then bring this end to the Threaded Faucet Stem. Screw the Compression Nut onto the Threaded Faucet Stem with an adjustable wrench. Be careful not to over tighten.

Connection Type B - Add the Faucet Adapter to one end of the Blue Tubing. Then, screw the Faucet Adapter onto the Threaded Faucet Stem.

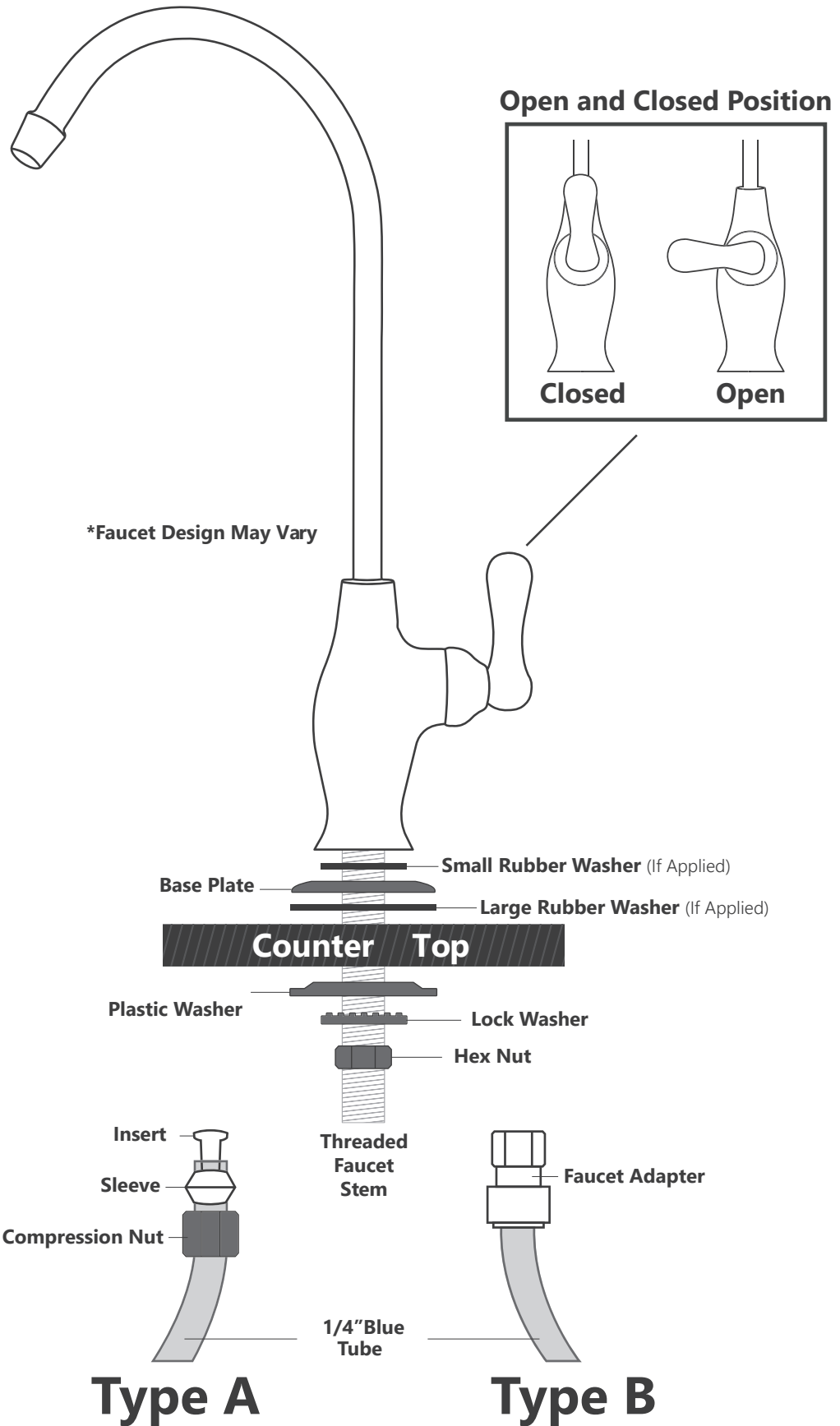

Drain Saddle

The Drain Saddle is used to connect the Black Drain Line to the drain pipe under the sink. The Drain Saddle is designed to fit around a standard 1.5 inch OD (outer diameter) drain pipe.

NOTE! Adjustable drain saddles are available upon request if the saddle does not fit your pipe.

The Drain Saddle should always be installed above (before) the P-Trap and on a straight vertical or horizontal section of pipe. To avoid clogging the drain line with debris do not install the Drain Saddle after the drain pipe meets a garbage disposal or dishwasher drain. The image below shows ideal Drain Saddle locations.

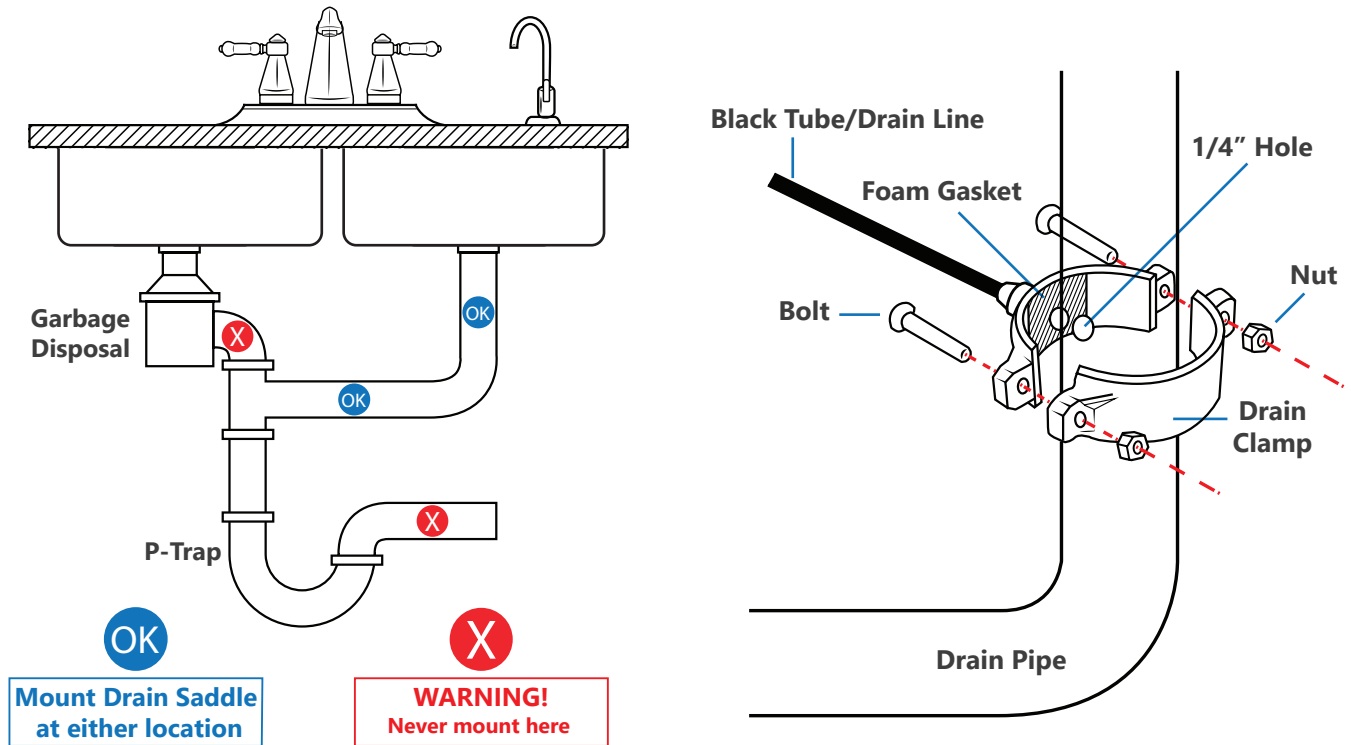

*Adjustable drain saddles are available if the saddle does not fit your pipe

1. Once you have found where your Drain Saddle will go on the Drain Pipe make a mark for the opening there with a marker or pencil.
2. Use your drill and an appropriate 1/4 inch (6.35mm) drill bit to drill a hole at your mark. Be careful to drill through only one side of the pipe. Stabilize your pipes while drilling to avoid damaging them.
3. Find the half of the Drain Clamp with a hole in its center. Then remove the backing from the Foam Gasket (the foam circle at the center of the Gasket is disposable). Make sure to align the Foam Gasket hole with the Drain Clamp hole and stick the adhesive side of the Gasket to the inner wall of the Drain Clamp half.
4. Take the half of the Drain Clamp without the Foam Gasket and insert a nut into the recess on each side.
5. Position both halves of the Drain Clamp on the drain pipe with the clamp's opening aligned over the drilled hole. The Foam Gasket will be between the drain clamp and the drilled hole. Push your 1/4 inch drill bit through both holes (the Drain Clamp hole and the hole in the Drain Pipe) and remove to verify that the clamp is properly aligned with the hole you drilled.
6. Secure the Drain Clamp halves together in place on the Drain Pipe. Screw the bolts through the Drain Clamp half with the Foam Gasket and into the half you installed the nuts. Do not over tighten. When tightening bolts make sure there is equal space on both sides between the Drain Clamp halves.

Housing Assembly

Prepare Prefilters

Leave the filters wrapped until you need them. When installing be careful not to touch the filter portion with your hands.

Remove the plastic wrap from the 3 Filter Housings and stand them upright. Make sure each Housing has two O-Rings firmly in place at the top of the Housing and in the Housing's lower groove.



Top Part of the Unit

NOTE!

Reference image to place each of the prefilters in the correct order:

- the yellow Sediment Filter will be on the far right (under the label "TO FEED").
- the blue Carbon Block Filter will be on the opposite side, the far left.
- the green GAC Filter will be in the center, between the other two. The white washer will be facing up for correct placement.



Attention

1. The RO Membrane is already on the system. To make sure the cap is secure, tighten the RO Membrane Housing Cap clockwise by Wrench or hand.
2. Use your hands to screw each Filter Housing onto the RO System. Finish tightening each housing using the filter wrench. **DO NOT OVERTIGHTEN!**

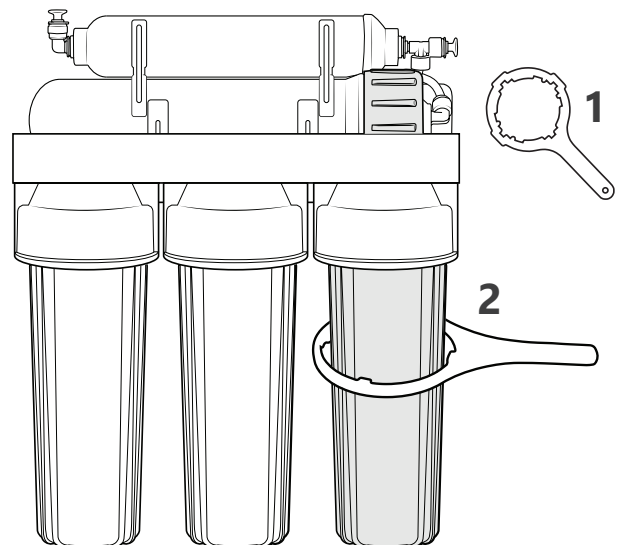

Elbow Fitting Installation



1. Screw a Male Elbow Fitting into the right-most Filter Housing (Sediment) marked "IN". Screw until tightened and the arm of the Elbow is facing downward.



2. Secure the White Tubing into the Male Elbow Fitting. Push hard enough on the tubing to make sure the Quick Connect has locked before moving on.



3. Screw the other Male Elbow Fitting (with red plug) into the leftmost Filter Housing (Carbon Block) marked "OUT". Screw until tightened and the arm of the Elbow is facing upwards at an 11 O'Clock angle (use the above image for reference).



4. Remove the Red Plug. Secure the Red Tubing into the Male Elbow Fitting. Push hard enough on the tubing to make sure the Quick Connect has locked before moving on.

Gauge Installation

NOTE!

Not all RO Systems include a Pressure Gauge. If your system does include a Gauge we will install it now.

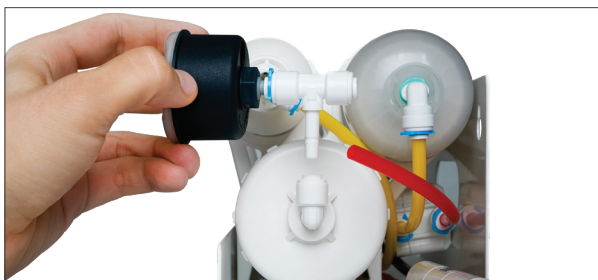

1. Put the end of the Pressure Gauge into one of the top arms of the Stem Tee. Then, put the Red Tubing into the opposite end as shown. Both will go about 5/8ths inch into the tee to secure.

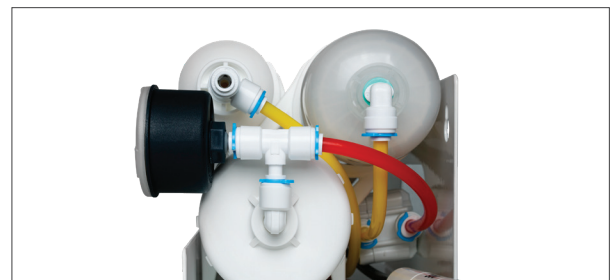

2. Put the small bottom end of the Stem Tee into the Male Elbow of the RO Membrane Cap. Use Blue Locking Clips to secure all 3 connection points as shown.

Leak Stop Valve

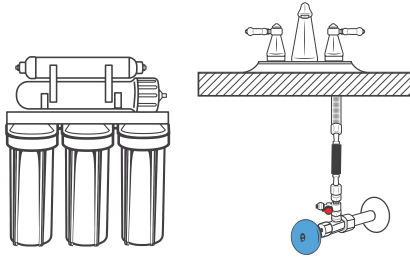

1. Position the RO System in the desired permanent location. Your system can be placed on its back for space if needed.

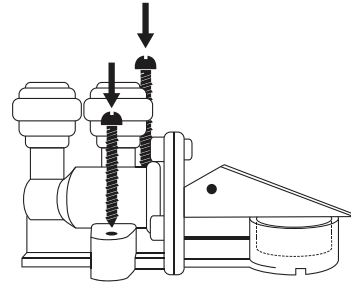

2. Position the Leak Stop Valve on the floor of the same cabinet beside the system. Any leaking water needs to make contact with the valve. Use the two screws to secure the Valve to the cabinet floor. Place the Leak Stop Valve in the lowest possible location beside the RO System.

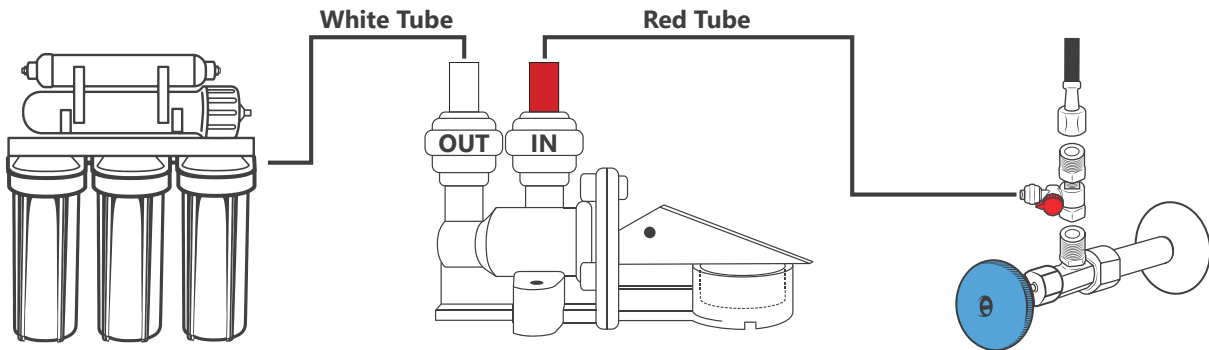

3. Connect one end of the Red Tubing into the Feed Water Adapter Valve and connect the other end of the Red Tubing into the hole marked "IN" on the Leak Stop Valve. Then connect one end of the White Tubing into the hole marked "OUT" on the Leak Stop Valve and connect the other end of the White Tubing into the Male Elbow Fitting attached to the Sediment Filter Housing marked "IN".

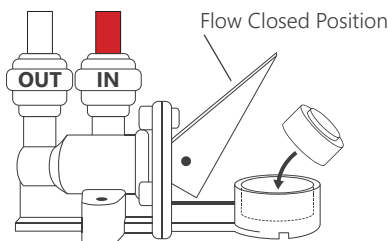

4. Take the plastic wrap off of the Compressed Textile then place the Textile inside the Leak Stop Valve as shown above. You may wish to insert the Compressed Textile after System Startup is complete in case of early monitored leaks.

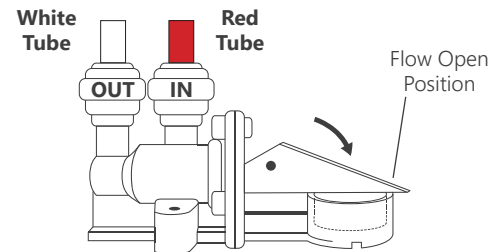

5. Turn the Stop Switch down and the Leak Stop Valve is ready.

Note! Please avoid contact of any liquid to the compressed textile. Failure to do so will activate the textile and shut off the incoming water. Textile will not work if plastic wrap is not removed.

Please do not re-use Leak Stop pads once activated.

Water Storage Tank

NOTE! Do not tamper with the air valve on the lower side of the Water Storage Tank. It has been preset at 7-10 PSI.

1. Open the Water Storage Tank box and unscrew the Tank Stand from the threaded stem at the top of the Tank.
2. Wrap the threaded stem 8-10 times with Teflon Tape.
3. Screw the Tank Valve onto the threaded stem. Make sure it is tight, but do not over tighten.
4. Place the Water Storage Tank near the RO System in the desired location. The Tank can stand up straight or lie on its side.
5. Connect the Yellow Tubing to the Stem Run Tee of the PAC Filter, then to the Tank Valve (See I to J on Page 23).
6. Keep the Tank Valve in the Closed Position until System Startup.

NOTE! If 3-5 hours after startup your tank does not fill: Connect the tank directly to the cold water supply (bypassing the RO System) and allow the tank to fill for about 1 minute. Then reconnect to your system as normal and empty the tank through faucet. This will help activate the tank bladder.



A. Tank Thread



B. Tank Valve



C. Tank Stand

NOTE! The Tank Valve only controls water leaving the Water Storage Tank. To stop all incoming water use the Feed Water Adapter Valve.



OPEN POSITION



CLOSED POSITION

System Connections

You may have already completed some or all of these connections in previous steps. Make sure to remove any plugs before installing Tubing. Use the provided Locking Clips to secure any Tubing connections.

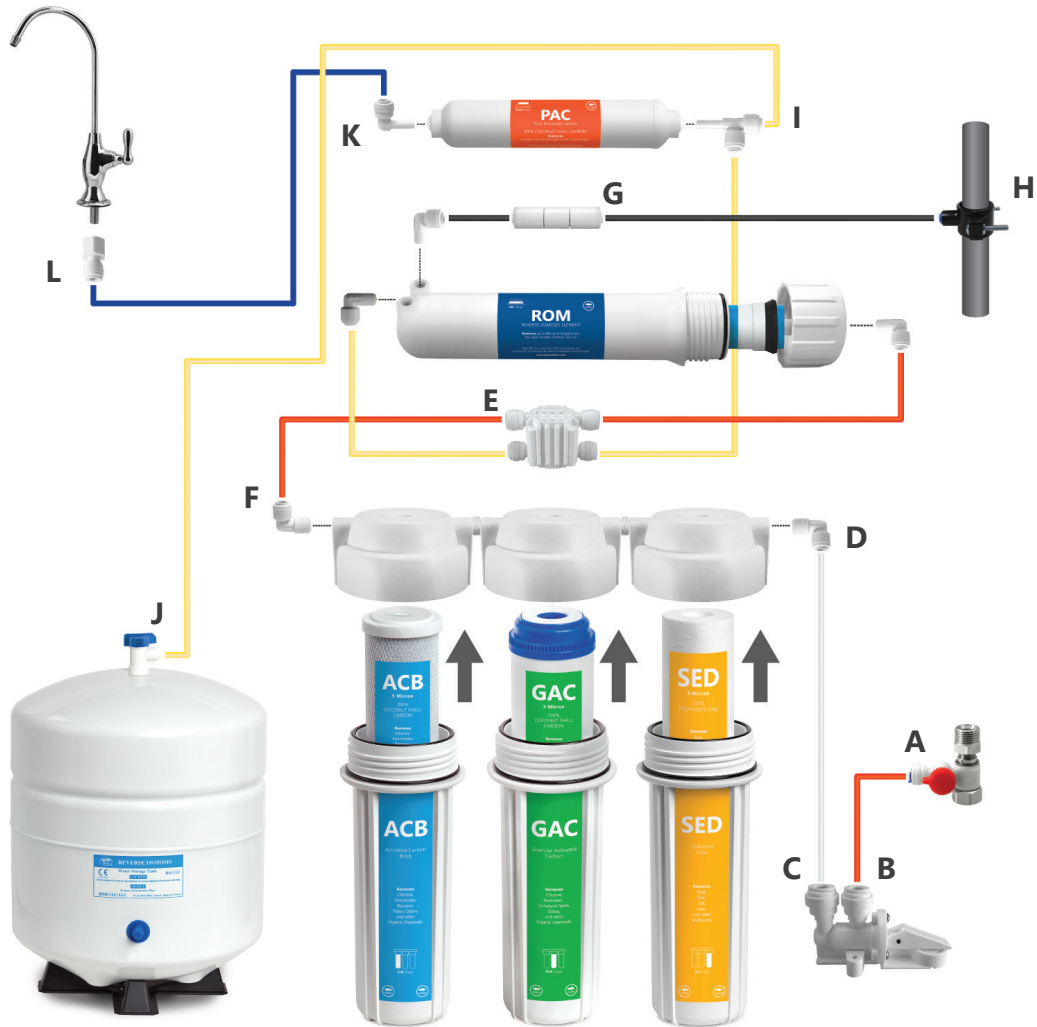

A to B Connect the RED Tubing to the Feed Water Adapter Valve (point A), then to the hole marked "IN" on the Leak Stop Valve (point B).

C to D Connect the WHITE Tubing to the hole marked "OUT" on the Leak Stop Valve (point C), then to the Sediment Filter Housing's Male Elbow Fitting (point D).

E to F The RED Tubing is already connected to the Automatic Shut-Off Valve (point E), connect the loose end to the Carbon Block Filter Housing's Male Elbow Fitting (point F).

G to H Connect the BLACK Tubing to the Flow Restrictor side indicated by the arrow on the Restrictor (point G), then to the Drain Saddle (point H).

I to J Connect the YELLOW Tubing to the PAC Filter's Stem Run Tee (point I), then to the Water Storage Tank's Tank Valve (point J).

K to L Connect the BLUE Tubing to the Stem Elbow at the end of the PAC Filter (point K), then to your RO Faucet connection (point L).

System Startup

Time Estimate: 8-12 hours (We recommend running 4 full tanks of water through your new system. Each tank should take 2-3 hours, depending on your home's water pressure levels).

NOTE! Do not drink water from your new system until you have completed System Startup. The flushing process is needed for your filters to begin working.

NOTE! Do not send water through your fridge until flushing is complete, carbon fines flushed during startup will clog your refrigerator.

1. Turn the Tank Valve to the Closed position (refer to page 22).
2. Open the water supply to the RO System (use Cold Water Supply and Feed Water Adapter Valve refer to pages 14 and 15). *Make sure the main water supply is also on.*
3. Open handle on the RO Faucet (refer to page 17) and wait up to 10 minutes for water to start dripping from the faucet. Let the water drip for 30 minutes.
4. Close the handle on the RO Faucet and wait 10 minutes for pressure to build. Then carefully check your RO System for any leaks. Feel or visually inspect every connection point for leaks. If a leak occurs, turn the Feed Water Adapter Valve OFF (refer to page 27).
5. Turn the Tank Valve to the Open position.
6. Allow the Water Storage Tank to fill completely (this takes about 2-3 hours depending on your incoming water pressure).
7. Flush the system by opening the RO Faucet handle until the stored water is completely emptied and the flow is reduced to a trickle (about 1-5 minutes).
8. Close the RO Faucet handle and allow the Tank to fill again.
9. Repeat steps 6-8 two more times (about 4-6 hours). *Occasionally check for leaks during this time*
10. Let the tank fill one final time and sit overnight (8+ hours) before flushing the water.
11. After the 5th tank is filled you may drink the water.
12. **Check for leaks daily during the 1st week of use and periodically thereafter.**

NOTE! You may notice that the water has a milky color during the 1st week. This is an indication of air bubbles in the water. This is normal during this period and the water is safe to drink.

System Maintenance

These recommendations are intended for maximum efficiency of your RO System.

Filter and RO Membrane Storage

- Store unopened filters in an airtight container to prevent them from absorbing air. This prolongs the shelf life of the filters and avoids any possible odors or contamination from the air.
- Store in a cool, dry, dark place (avoid heat and moisture contamination). Using this method it is okay to store filters for several years.

Extended System Non-Use

- If you will not be using the RO System for two weeks or more you will need to follow the "Vacation Mode" guide on page 27.

Filter Change Instructions

This RO System contains Filters that must be replaced at regular intervals to maintain proper performance. Use only authentic **Express Water** filters.

How to Change the Sediment, GAC, and Carbon Block Filters (Prefilters)

(Recommended about every 6 months)

1. You will need a clean cloth, dish soap, filter housing wrench and appropriate Sediment, GAC, and Carbon Block Filters. *We also recommend a bucket or bin large enough for the system to sit in. The system will release water when it is disassembled.*
2. Turn off the Cold Water Supply connected to the RO System (refer to page 14), the Feed Water Adapter Valve (page 15), and the Tank Valve (page 22). Then open the RO Faucet handle to release pressure, close handle when the flow of water stops.
3. Place the RO System in the bucket and unscrew the 3 Prefilter Housings using the Filter Housing Wrench. Remove old filters and dispose of them.
4. Wash the Prefilter Housings with dish soap then proceed to rinse until all soap is removed.
5. Ensure that your hands are clean before unwrapping the new filters. After unwrapping, place the new filters inside their correct housings (refer to page 19). Make sure the O-Rings are in their proper locations.
6. Tighten the Prefilter Housings using the Filter Housing Wrench. Do not overtighten. If these are the only filters you are replacing continue to the Restarting the System section on Page 26.



How to Change the RO Membrane

(Recommended about once a year)

NOTE! Make sure you have shut down the RO System (Step 2 in the above section).

1. Open the RO Membrane Housing by unscrewing the cap. Pull out the RO Membrane with a pair of pliers. Be sure to note which side is the front and which side is the back.
2. Wash out the RO Membrane Housing. Install the new RO Membrane in the Housing in the correct direction you noted earlier. Make sure to push the Membrane in firmly, then close the Housing by tightening the cap with your hand. If this is the only/last filter you are replacing continue to the Restarting the System section on Page 26.

Make sure the O-Ring is in place before you tighten the Membrane Housing Cap



How to Change the Inline Post Carbon Filter

(Recommended about once a year)

NOTE! Make sure you have shut down the RO System (Step 2 in the Prefilters section).

1. First disconnect the Stem Elbow and Stem Tee from the sides of the Inline Post Carbon Filter.
2. Note the orientation of the old filter and install the new filter in the same orientation. Remove the old filter from the holding clips and discard. Next, insert the new filter into the holding clips and connect the Stem Elbow and Stem Tee to the new Inline Post Carbon Filter (check page 12 for layout). If this is the only/last filter you are replacing continue to the Restarting the System section on Page 26.



Restarting The System

1. Fully open the Feed Water Adapter Valve, Cold Water Supply, and the Tank Valve.
2. Open the RO Faucet handle and fully empty the tank before turning the Faucet handle off.
3. Let the system refill with water (this takes 2-3 hours). You can open the RO Faucet briefly to release any air trapped inside the system while it's filling. (Be sure to check for new leaks during the first 24 hours after restarting.)
4. After the Water Storage Tank has filled drain the entire system by opening the RO Faucet until the water flow is reduced to a slow trickle. Then close the Faucet.
5. Repeat steps 3 and 4 three times to fully flush the system (6-9 hours)

NOTE! If the RO System is connected to a refrigerator do not drain the system through the refrigerator water dispenser. The excess carbon fines from the new carbon filter will clog the internal fridge filter.

How to Sanitize your RO System

(Recommended Once a Year)

1. Before you begin you will need a new Sediment Filter, GAC Filter, Carbon Block Filter, RO Membrane, Inline Post Carbon Filter, and the Filter Housing Wrench. We also suggest using a bucket or bin large enough for the system to sit in (the system will release a lot of water when it is disassembled).
 2. Turn off any incoming water (Feed Water Adapter Valve).
 3. Open the RO Faucet handle and drain the system completely (wait until water flow stops completely), then close the Faucet handle.
 4. Use the Filter Housing Wrench to open the Filter Housings, then remove and dispose of ONLY the following filter cartridges: **Sediment Filter, GAC Filter, Carbon Block Filter, and RO Membrane**
- NOTE! Leave the Inline Post Carbon Filter in place! You will replace it after sanitizing the system.**
5. Mix 1 gallon of water with 2 tbsp of household bleach. Do not add bleach directly to the filter housing.
 6. Fill up the Pre Filter Housings (Sediment, GAC, and Carbon Block Housings) with your mixed solution and close the housings using your Filter Housing Wrench.
 7. Open the incoming water to the system (Feed Water Adapter Valve) and let it run for 10 minutes.
 8. Open the RO Faucet handle and let it drain for 10 minutes.
 9. Close the RO Faucet handle and wait for 10 minutes then open the Faucet handle again and wait for it to drain completely.
- If you smell bleach from your RO Faucet repeat steps 7-9.**
10. You are now ready to replace all filters and restart your system. Please refer to System Startup section for detailed instructions, ignore any additional sanitation steps therein.

Troubleshooting

Note! Turn off the system before servicing or inspecting

Problem	Cause	Solution
Milky colored water Air bubbles in the water	- Air in system	* Air in the system is a normal occurrence with initial startup of the RO System. This milky look will disappear during normal use within 1 to 2 weeks.
Noise from the system	- Air gap in Faucet - Location of Drain Saddle - Restrictions in drain line	* Will disappear after system shutdown. * Relocate the Drain Saddle to above P-Trap. * Blockage sometimes caused by debris from garbage disposal or dishwasher.
Slow production or no water from RO Faucet	- System just starting up - Air pressure in Water Storage Tank is low - Tank Valve is closed - Low water pressure - Crimps in tubing - Clogged Prefilters - Fouled RO Membrane	* Normally it takes 2-3 hours to fill the tank. Low water pressure and/or temperature can reduce production rate. * Add pressure to the storage tank. The pressure should be 8-10 PSI when the tank is empty. * Add a booster pump. * Make sure tubing is straight. * Replace Prefilters. * Replace RO Membrane.
Water taste or an offensive smell	- Drain line clogged - Inline Post Carbon Filter is depleted - Fouled RO Membrane - Sanitizer not flushed out	* Replace Inline Post Carbon Filter. * Replace RO Membrane. * Drain Water Storage Tank and refill it.
No drain water	- Clogged Flow Restrictor	* Replace the Flow Restrictor.
Leaks	- Fittings are not tightened - Twisted O-Ring - Misalignment of hole in Drain Saddle - Threaded Connections	* Tighten fittings as necessary. * Replace the O-Ring. * Realign Drain Saddle * Replace Teflon Tape with 7-10 rounds
No Water	- Check Leak Stop Valve - Check Feed Water Adapter Valve	* Refer to page 21 * Refer to page 15

Vacation Mode

When you plan to not use your RO System for 2 weeks to 1 month it should be Turned Off. Locate the red Feed Water Adapter Valve connected to your Cold Water Supply (refer to page 13).

Turn Off System: Turn the red Feed Water Adapter Valve to point away from the Red Tubing connection (in the Closed position, page 13) to close the water supply to the system.

Turn On System: Turn the red Feed Water Adapter Valve to point towards the Red Tubing connection (in the Open position, page 13) to open the water supply to the system.

For deactivation of 1 month or more:

1. Shut off the incoming water supply and drain entire system of water through the RO faucet.
2. Remove each filter and place vertically on a clean surface until dry.
3. Place each filter individually in a sealed air tight plastic wrap and place in the refrigerator for the duration (if filter is reusable and less than 3 months old).
4. You may leave the System and Filter Housings disassembled to ensure it stays dry to prevent bacteria growth.
5. You should wash the filter housings before replacing the filters, when you are ready to restart the system.

NOTE! Depending on your area's water you may not be able to reuse some or all of your filters. Please contact us if you need more information.

FAQ's

Does this system filter Fluoride, Lead, Pharmaceuticals, and Arsenic?

Yes, as well as Cyanide, Phosphate, Pesticides, Sodium, Cadmium, Sulfates, and many other contaminants up to certain levels. You may need other changes to media for high levels of these substances.

What PSI do I need? What is the operating pressure?

The minimum PSI for the system is 40 and the maximum PSI is 80. If your PSI is too low you can purchase a Booster Pumps to aid your system. If your PSI is too high you can purchase a Pressure Regulator to reduce your pressure to acceptable levels. Let us walk you through these options; call us at 1-800-992-8876 or visit expresswater.com

Does this system soften water?

Your RO System will soften water. However, hard water does reduce the lifespan of your Filters.

Does it stop filling automatically when filled? Why is the drain line constantly flowing?

The RO System does stop filling automatically when tank is filled (2-3 hours). If your drain line is constantly flowing this is a sign that your incoming water pressure is too low.

Can I install this system in the basement? If so, will it affect the efficiency of the RO System?

Yes, the RO System can be installed in a basement. However, if you do not have adequate water pressure you may need to purchase a Delivery Pump. Contact Express Water and we'll help you find your solution.

What is the discharge rate?

The typical discharge range is one to three gallons for every one gallon of drinking water produced. Your water pressure, incoming water quality, and water temperature will affect your RO System's discharge rate.

Why does it take so long to fill up the tank?

The purification process takes some time on its own. However, some water takes longer to process. Your water pressure, incoming water quality, and water temperature will all affect how quickly your RO System fills the Water Storage Tank.

How often do I change Filters? Is there an indicator?

The Sediment, GAC, and Carbon Block Filters should be changed every 6 months. The RO Membrane and Inline Carbon Filter should be changed every one year at the same time as the second change of the 6 month filters. There is no direct indicator for filter changes. However, if you notice a drop in water quality before the 6 months or 1 year mark this may mean that due to your water quality your filter has degraded. If you reach 6 months or 1 year without noticing a change in taste you should still change your filter at this point as they are no longer viable.

Can I add additional filters to my current system?

Yes, each system is fully upgradeable. Check the Upgrades and Accessories section at expresswater.com for more information.

Can I connect this system to a refrigerator or icemaker?

Yes, you may need an Express Water Refrigerator Kit to do so. In some cases, your situation may require a separate tank or Delivery Pump depending on how far away your refrigerator is from the system. Contact Express Water and we'll help you find your solution.

Can I reuse discharge water?

Never consume discharge water. With proper installation it is possible to utilize your discharge water. Contact Express Water to speak with a qualified representative who can give you more information based on your situation.

How long does the system last? How long does the tank last?

With proper maintenance and average water quality an RO System should last 5-10 years. The water storage tank usually lasts 3-5 years before we recommend replacing it.

Can I change my 50 GPD (Gallons Per Day) system to 100 GPD? If so, how?

Yes, to do so, you will need different parts (such as the RO Membrane and Flow Restrictor). Contact Express Water and we will help you arrange your upgrade.

Why are there bubbles in the water?

Bubbles in your water is a common issue, but they only affect the appearance of your water and pose no risk. There can frequently be air trapped inside any plumbing system, so the air may be coming from your home's plumbing and not the RO System. Trapped air happens frequently when you change a filter, when there is a leak in your system or plumbing, or even when there is construction in your area. Check your system carefully for any leaks or unexplained moisture. You may need to carefully tilt the system various directions then set it back in place to help release trapped air.

Does this produce aquarium safe water?

While the water is perfectly safe for human consumption, we suggest installing our Deionization Filter Upgrade to create water for aquatic life.

Why do I need to flush the system?

New filters (or filters that have experienced extended disuse) can develop carbon residue. We recommend emptying the Water Storage Tank four times (which can take 8-12 hours) to release any extra carbon before the water is safe to drink.

How much water can the Water Storage Tank hold?

The maximum capacity of the tank is 3.2 gallons. However, the typical tank reaches 2-2.5 gallons. Your Water Storage Tank's capacity depends on your incoming water pressure. Lower water pressure means the tank will hold less water.

What other filters can I add to my system?

Express Water offers many upgrade filters including a UV Sterilizer, a Deionization Filter, an Alkaline Mineralizer, and other options. You cannot normally use a deionization filter and alkaline filter together, but it is possible to use them on one system separately. Contact us if you have any questions about additional drinking water or whole house filtration.

What if I need to produce more water?

There are a lot of solutions to this problem, it's possible to upgrade your drinking water system with some specialty equipment or we can help you with other solutions. Just contact us and we can help you find the solution that best fits your home.

What should I do in a boil water advisory?

As long as all of your filters are working properly you can drink water from your RO system without boiling. However, you should replace all of your filters after the order is lifted. While the system will filter large amount of harmful agents it can damage your filters and cause bacteria to grow. You should follow sanitization instructions when replacing the filters.

Upgrades and Accessories

Add additional stages or features to your RO System. Visit expresswater.com for more information.



Water Chiller

The easy to install compact Power Chiller allows you to have cold refreshing water on demand from your RO Faucet.



Pressure Regulator

If your water pressure is too high for the RO System the Pressure Regulator will reduce your incoming pressure.



Pressure Gauge

A Quick Connect optimized 160 PSI Pressure Gauge for monitoring incoming water pressure on your RO System.



Alkaline Filter and Upgrade Kit

Adds a five-layer Alkaline mineralization stage to your RO System. This filter produces more PH Positive water with antioxidants and up to 20% more oxygen.



Ultraviolet Sterilizer and Upgrade Kit

Adds a UV light sterilization stage to your RO System. This effectively eliminates up to 99.99% of microorganisms, fungi, cysts, viruses, and harmful bacteria like E. coli.



Deionization Filter and Upgrade Kit

Deionization removes Total Dissolved Solids (TDS) from your water via ion exchange, giving you purer drinking water.



Refrigerator Kit

Extra tubing and connections to supply your refrigerator with RO purified water.



Water Storage Tanks

100% food grade water storage tanks in sizes from 2 to 40 gallons



Adjustable Booster Pump

If your water pressure is too low for the RO System the Booster Pump will increase your pressure.

1 Year Limited Warranty



We Cover

This warranty covers any defects in the parts or manufacturing of your Express Water Reverse Osmosis Water Filtration System. We will give you new replacement parts in exchange for any defective parts.

What to Do

Give us a call at 1-800-992-8876 or send an email to support@expresswater.com and describe the problem to our support. Be sure to have a copy of your purchase confirmation email or receipt. Our support will verify that the product and problem are under warranty and help you arrange to send your defective part back to Express Water with your receipt and contact information (name, address, phone number, email address). Support will help arrange sending of the defective part, the delivery of your replacement part, as well as guiding you through the installation.

Time Covered

This warranty is effective for 1 full year from the date of original purchase.

Not Covered

This warranty does not cover labor for removal or installation, accumulation of dirt or grime (you are responsible for your own cleaning), systems with the serial number removed or altered, damage from improper storage (high or low temperature, sun damage, etc), damage from a system not installed as instructions directed, anyone other than original purchaser, damage from system abuse or unintended operation of system, acts of God, improper water source, modification, negligence, commercial use of the system, Filters, RO Membrane, incidental damages from system failure, systems used with parts not provided by Express Water (including tanks, filters, faucets, pumps, diverter valves), or cosmetic damages.

Your State

Some states has further regulation on damages and warranty coverage. You may have other rights depending on your state.

For warranty questions, service, or help give us a call **Monday - Friday 10 am to 5 pm PST:**

1-800-992-8876

Email us:
support@expresswater.com

Express Water Inc.
12730 Raymer St, Unit 1, North Hollywood, CA 91605



EXPRESS
W A T E R

www.expresswater.com

1-800-992-8876