

USE AND CARE GUIDE

6-LIGHT CHANDELIER

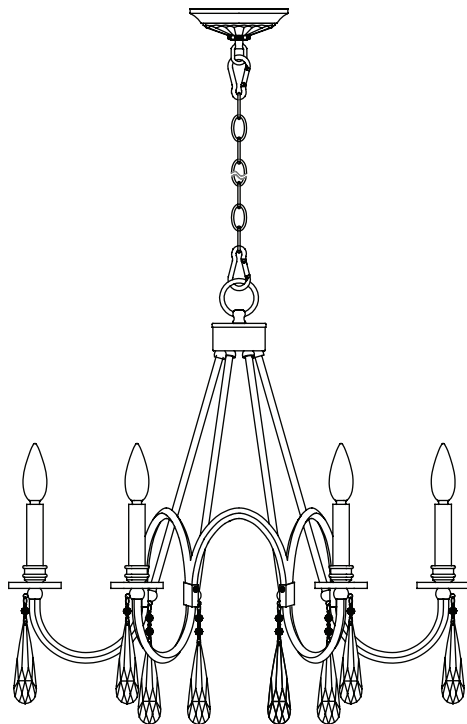

Questions, problems, missing parts? Before returning to the store,
call Home Decorators Collection Customer Service
8 a.m. - 7 p.m., EST, Monday - Friday, 9 a.m. - 6 p.m., EST, Saturday

1-800-986-3460

WWW.HOMEDEPOT.COM/HOMEDECORATORS

THANK YOU

We appreciate the trust and confidence you have placed in Home Decorators Collection through the purchase of this 6 Light chandelier. We strive to continually create quality products designed to enhance your home. Visit us online to see our full line of products available for your home improvement needs. Thank you for choosing Home Decorators Collection!

Table of Contents

Table of Contents.....	2	Hardware Included.....	3
Safety Information.....	2	Package Contents.....	4
Warranty.....	2	Installation.....	5
Pre-Installation.....	3	Care and Cleaning.....	9
Planning Installation	3	Troubleshooting.....	9
Tools Required.....	3		

Safety Information

- Read all instructions before installing.
- Consult a qualified electrician for installation of this fixture.
- If you have any non-electrical questions about this fixture, please contact our Customer Service Team at 1-800-986-3460 or visit www.homedepot.com/homedecorators
- Please reference your SKU 1001 352 741 or UPC 773546255240.
- Save these instructions for future reference.

 **DANGER:** Risk of electrical shock. Disconnect power before installation.

 **IMPORTANT:** Inspect the wire insulation for any cuts, abrasions, or exposed copper that have occurred during shipping. If there is a defect in the wire, do not continue the installation process. Please call our Customer Service Team at 1-800-986-3460.

Warranty

LIMITED WARRANTY

WHAT IS COVERED

The manufacturer warrants this lighting fixture to be free from defects in materials and workmanship for a period of five (5) years from date of purchase. This warranty applies only to the original consumer purchaser and only to products used in normal use and service. If this product is found to be defective, the manufacturer's only obligation, and your exclusive remedy, is the repair or replacement of the product at the manufacturer's discretion, provided that the product has not been damaged through misuse, abuse, accident, modification, alteration, neglect, or mishandling.

WHAT IS NOT COVERED

This warranty shall not apply to any product that is found to have been improperly installed, set-up, or used in any way not in accordance with the instructions supplied with the product. This warranty shall not apply to a failure of the product as a result of an accident, misuse, abuse, negligence, alteration, faulty installation, or any other failure not relating to faulty material or workmanship. This warranty shall not apply to the finish on any portion of the product, such as surface and/or weathering, as this is considered normal wear and tear. The manufacturer does not warrant and specially disclaims any warranty, whether express or implied, of fitness for a particular purpose, other than the warranty contained herein. The manufacturer specifically disclaims any liability and shall not be liable for any consequential or incidental loss or damage, including but not limited to any labor/expense costs involved in the replacement or repair of said product.

Contact Customer Care at 1-800-986-3460 or visit www.homedepot.com/homedecorators.

Pre-Installation

PLANNING INSTALLATION

Read all instructions before assembly and installation. To avoid damaging this product, assemble it on a soft, non-abrasive surface, such as carpet or cardboard. Inspect each part for defects that may have occurred during shipping. Keep your receipt and these instructions for proof of purchase.

TOOLS REQUIRED



Safety goggles



Phillips screwdriver

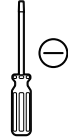

Flathead screwdriver



Wire strippers



Wire cutters

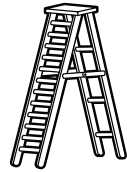

Ladder

HARDWARE INCLUDED



NOTE: Hardware not shown to actual size.

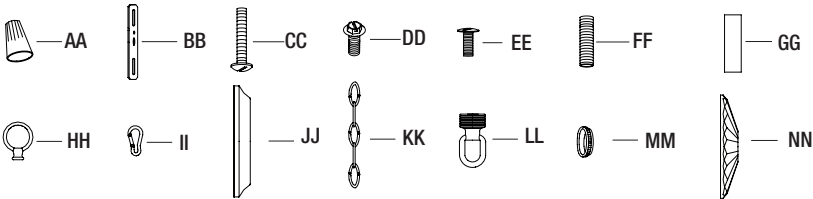

Part	Description	Quantity
AA	Wire nut	3
BB	Cross bar	1
CC	Outlet box screw	2
DD	Ground screw	1
EE	Screw	3
FF	Nipple	1
GG	Candle sleeve	6
HH	Fixture loop	1
II	Chain link	2
JJ	Canopy	1
KK	Fixture chain	1

Part	Description	Quantity
LL	Canopy loop	1
MM	Loop ring	1
NN	Canopy crystal	1

Pre-Installation (continued)

PACKAGE CONTENTS

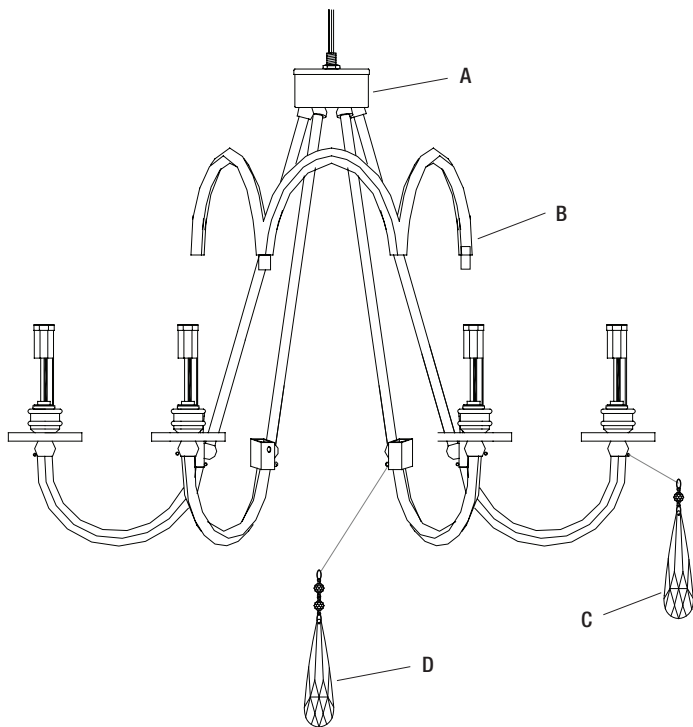

Part	Description	Quantity
A	Fixture body	1
B	Decorative arm	1
C	Single-bead crystal	6
D	Double-bead crystal	6

Installation

1 Assembling the fixture

- Unfold the fixture arms, as shown below.
- Insert the decorative arm (B) onto the fixture body (A) and secure with the screws (EE).

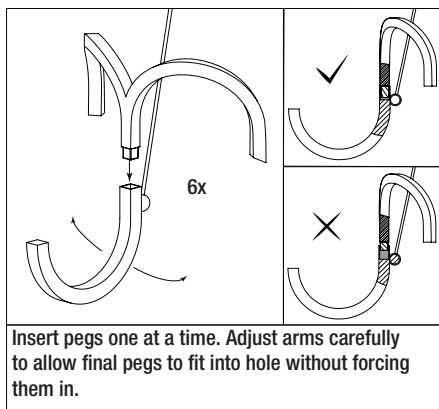
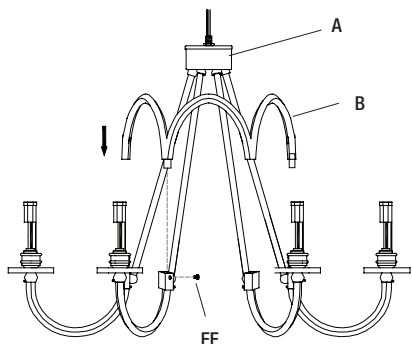
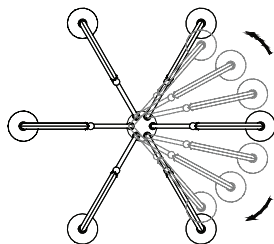

2 Installing the cross bar

- Secure the cross bar (BB) to the outlet box (not included) with the outlet box screws (CC). Tighten until snug.
- Attach the canopy loop (LL) to the nipple (FF) of the cross bar (BB).

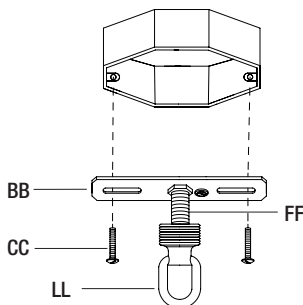

3 Attaching the fixture chain

- Secure the fixture loop (HH) to the fixture body (A).
- Adjust the fixture chain (KK) to the desired length by moving the links if needed. Connect the fixture chain (KK) to the fixture loop (HH) and canopy loop (LL) by using the chain links (II).
- Pull the power cord up through the fixture chain (KK), alternating links. Push the wires up through the canopy loop (LL), canopy crystal (NN) and canopy (JJ) into the outlet box.

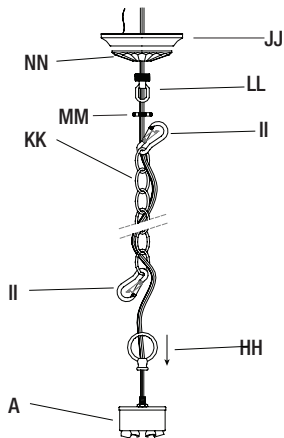

Installation (continued)

4 Making the electrical connections and locking the canopy



NOTE: Always use wire nuts (AA) or marrettes (included) to connect wires and push all excess wires and connections back into the junction box.

- Connect the ground wire from the branch circuit to the green ground screw (DD) on the cross bar (BB) and add 6 in. for the ground connection.
- Connect the fixture wires as the figure shows.
- Attach the canopy crystal (NN) and canopy (JJ) to the outlet box, and secure it with the loop ring (MM).

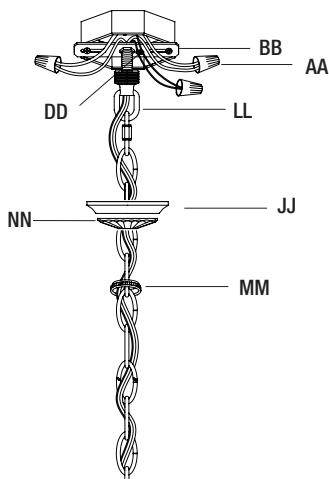
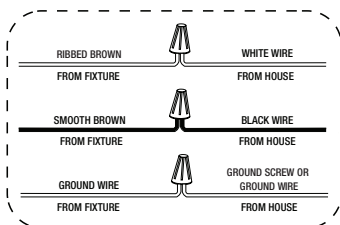

5 Installing the decorative crystals

- Carefully attach the single-bead crystals (C) and double-bead crystals (D) to the hooks of the fixture body (A).

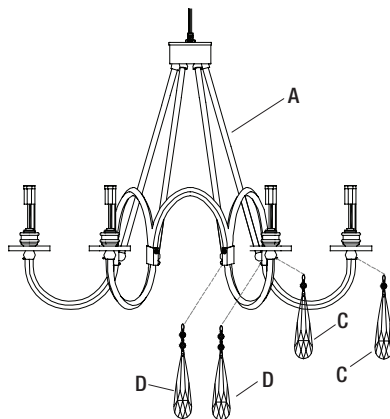

6 Installing the candle sleeves

- Insert the candle sleeves (GG) onto each socket of the fixture body (A).

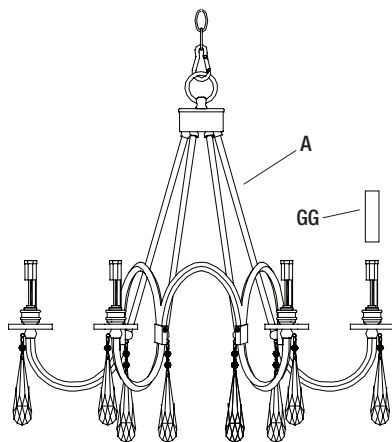

7 Installing the bulbs

- Install 60W max. B10 bulbs (not included) into each socket of the fixture body (A).

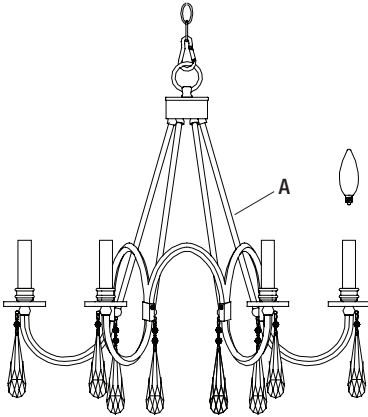

Care and cleaning

- Clean the light fixture carefully with a soft, dry cloth. Do not use any cleaner with chemicals, solvents, or harsh abrasives.

Troubleshooting

Problem	Possible Cause	Solution
□ The bulb will not light.	□ The bulb is burned out.	□ Replace the light bulb.
	□ The power is off.	□ Ensure that the power supply is turned on.
	□ The circuit breaker is off.	□ Ensure that the circuit breaker is set to the ON position.
□ The fuse blows or the circuit breaker trips when the light is turned on.	□ There are too many items on one circuit.	□ Unplug the other items on the circuit. □ Contact a qualified electrician or call the Customer Service Team at 1-800-986-3460.

HOME DECORATORS COLLECTION

Questions, problems, missing parts? Before returning to the store,
call Home Decorators Collection Customer Service
8 a.m. - 7 p.m., EST, Monday-Friday, 9 a.m. - 6 p.m., EST, Saturday

1-800-986-3460

WWW.HOMEDEPOT.COM/HOMEDECORATORS

Retain this manual for future use.