

6034CPAN – A² COMPOSITE PAN

inches (mm)

60 x 34 x 6 (1525 x 865 x 150) • Fax on Demand #2105

A² COMPOSITE

Lightweight and durable, our A² Composite is an engineered compound of resin, glass and special fillers formed into sheets. These sheets are then placed under high pressure and heat to liquify the compound, allowing it to flow and take the shape of almost any form imaginable. The results are simple, stylish and a snap to install.



FEATURES

- Shower pan
- Slip-resistant, textured bottom
- Extended tiling flange (3T)
- Enhanced front profile
- Available in White and Biscuit
- Patented design features:
 - corner drainage channels
 - step-design finishing guides
 - extended nailing flange
- Center drain
- Composite surface
- 10-year residential limited warranty

AQUATIC ADVANTAGE

- National distribution
- 5 manufacturing facilities
- Private fleet
- Centralized customer service
- Field support
- 24-hour fax-on-demand



6034CPAN

60 x 34 x 6 (1525 x 865 x 150)
inches (mm)

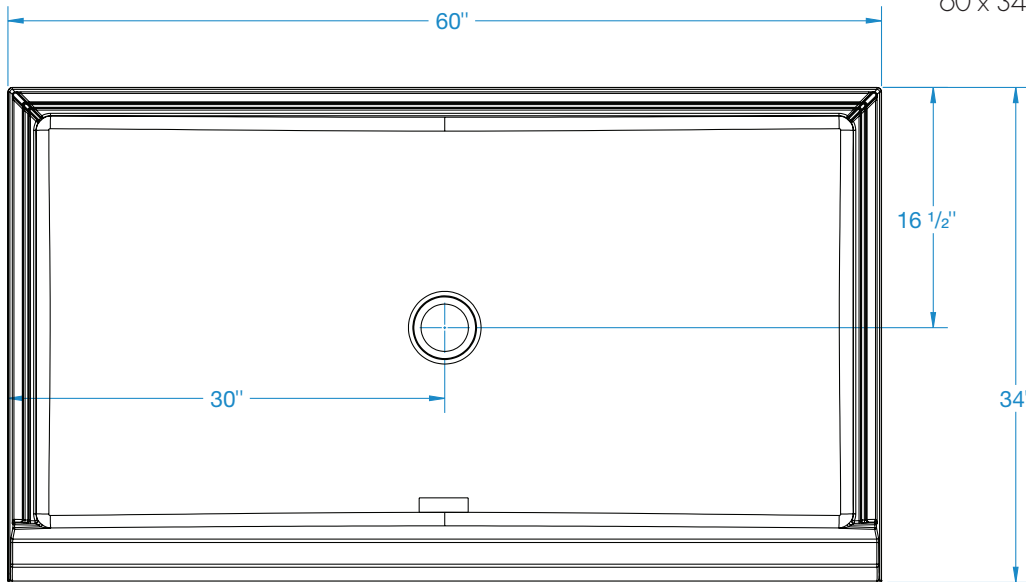

FEATURES lbs (kg) Dimensional Tolerance $\pm \frac{3}{8}$ ". Dimensions needed for site preparation should be measured from the unit. Aquatic assumes no responsibility for preparatory work.

Model #	Material	Drain	Net Wt.	Pkg. Wt.
Shower Pan #6034CPAN	Composite	Center	50 (23)	55 (25)

DIMENSIONS

Specifications	inches (mm)
Width: Overall / Net	60 (1525)
Depth: Overall / Net	34 (865)
Height: Overall / Net	7 (180) / 6 (150)
Enclosure Opening	-
Skirt Height	6 (150)
Drain Rough-In (from Back Wall)	16 1/2 (420)
Drain Rough-In (from Side Wall)	30 (760)
Drain: Diameter / Clearance	3 1/4 (85) / 3/8 (10)

FRAMING DIMENSIONS inches (mm)

Type	D Depth	W Width	H Height	A	B	C
Alcove	34 (865)	60 (1524)	-	Box Out	30 (760)	16 1/2 (420)

