



MAGNUM[®]

TRUEAIRLESS[™]

Electric Airless Sprayer



OWNERS MANUAL

Project Painter[™] Plus

3A3582B

EN



WARNING

FIRE AND EXPLOSION HAZARD

- Use only non-flammable or water-based materials, or non-flammable paint thinners. Do not use materials having flash points lower than 100° F (38° C). This includes, but is not limited to, acetone, xylene, toluene, or naphtha. For more information about your material, request Safety Data Sheet (SDS) from the supplier.
- Spraying flammable or combustible materials in a factory or fixed location must comply with NFPA 33 and OSHA 1910.94(c) requirements in the USA and with all similar local regulations in other countries.

***Not approved for use in explosive atmospheres or hazardous locations.
For portable airless spraying of architectural paints and coatings.***



Important Safety Instructions

Read all warnings and instructions in this manual, related manuals, and on the unit. Be familiar with the controls and the proper usage of the equipment. Save these instructions.

DIY SERIES

BEFORE YOU SPRAY

Review Warnings for Important Safety Information

Important! Read carefully and practice good safety habits.

Review Manual & Watch Videos

Scan QR code for Operational Video or go to magnum.graco.com/p3op

Related Manuals

Gun: 312830 (SG2)



Model

2800 psi (193 bar, 19.3 MPa) Maximum Working Pressure

	VAC	Model
 Intertek 110474 Certified to CAN/CSA C22.2 No. 68 Conforms to UL 1450	120 USA	257025

Important User Information

Thank You for Your Purchase!

Before using your sprayer read this Owners Manual for complete instructions on proper use and safety warnings.

This sprayer is designed to provide superior spray performance with water-based and oil-based (mineral spirit-type) architectural paints and coatings. This user information is intended to help you understand the types of materials that can be used with your sprayer.

Please read the information on the material container label to determine if it can be used with your sprayer. Ask for a Safety Data Sheet (SDS) from your supplier. The container label and SDS will explain the contents of the material and the specific precautions related to it.

Paints, coatings and clean-up materials generally fit into one of the following **3 basic categories**:



WATER-BASED: The container label should indicate that the material can be cleaned up with soap and water. Your sprayer is compatible with this type of material. Your sprayer is **NOT** compatible with harsh cleaners such as chlorine bleach.



OIL-BASED: The container label should indicate that the material is COMBUSTIBLE and can be cleaned up with mineral spirits or paint thinner. The SDS must indicate that the flash point of the material is above 100° F. Your sprayer is compatible with this type of material. Use oil-based material outdoors or in a well-ventilated indoor area with a flow of fresh air. See the safety warnings in this manual.



FLAMMABLE: This type of material contains flammable solvents such as xylene, toluene, naphtha, MEK, lacquer thinner, acetone, denatured alcohol, and turpentine. The container label should indicate that this material is FLAMMABLE. This type of material is **NOT** compatible with your sprayer and **CANNOT** be used.

Contents

Before You Spray	2
Warnings	5
Know Your Sprayer	9
Setup	10
Start Up	11
Pressure Relief Procedure	11
How to Spray	14
Adjust Pressure Control	15
Spray Techniques	15
Clear Tip Clog	16
Cleanup	17
Storage	21
Reference	23
Spray Tip Selection	23
Cleaning Fluid Compatibility	24
Static Grounding Instructions (Oil-Based materials)	24
Maintenance	27
Troubleshooting	28
Project Painter Plus: 257025 Sprayer Parts	32
Project Painter Plus: 257025 Sprayer Parts List	33
Wiring Diagram	34
Technical Specifications	35
Notes	36
Graco Standard Warranty	37
Graco Information	38

Warnings

The following warnings are for the setup, use, grounding, maintenance, and repair of this equipment. The exclamation point symbol alerts you to a general warning and the hazard symbols refer to procedure-specific risks. When these symbols appear in the body of this manual or on warning labels, refer back to these Warnings. Product-specific hazard symbols and warnings not covered in this section may appear throughout the body of this manual where applicable.

WARNING



GROUNDING

This product must be grounded. In the event of an electrical short circuit, grounding reduces the risk of electric shock by providing an escape wire for the electric current. This product is equipped with a cord having a grounding wire with an appropriate grounding plug. The plug must be plugged into an outlet that is properly installed and grounded in accordance with all local codes and ordinances.

- Improper installation of the grounding plug is able to result in a risk of electric shock.
- When repair or replacement of the cord or plug is required, do not connect the grounding wire to either flat blade terminal.
- The wire with insulation having an outer surface that is green with or without yellow stripes is the grounding wire.
- Check with a qualified electrician or serviceman when the grounding instructions are not completely understood, or when in doubt as to whether the product is properly grounded.
- Do not modify the plug provided; if it does not fit the outlet, have the proper outlet installed by a qualified electrician.
- This product is for use on a nominal 120V circuit and has a grounding plug similar to the plugs illustrated below.

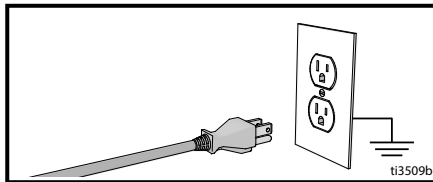

- Only connect the product to an outlet having the same configuration as the plug.
- Do not use an adapter with this product.

Extension Cords:

- Use only a 3-wire extension cord that has a grounding plug and a grounding receptacle that accepts the plug on the product.
- Make sure your extension cord is not damaged. If an extension cord is necessary use 12 AWG (2.5mm²) minimum to carry the current that the product draws.
- An undersized cord results in a drop in line voltage and loss of power and overheating.

Conductor Size		Length
AWG (American Wire Gauge)	Metric	Maximum
16	1.5 mm ²	25 ft. (8 m)
12	2.5 mm ²	50 ft. (15 m)

WARNING



FIRE AND EXPLOSION HAZARD

Flammable fumes, such as solvent and paint fumes, in work area can ignite or explode. To help prevent fire and explosion:



- Do not spray or clean with materials having flash points lower than 100°F (38° C). Use only non-flammable or water-based materials, or non-flammable paint thinners. For complete information about your material, request the Safety Data Sheet (SDS) from the material distributor or retailer.



- Do not spray combustible materials near an open flame or sources of ignition such as cigarettes, motors, and electrical equipment.



- Paint or solvent flowing through the equipment is able to result in static electricity. Static electricity creates a risk of fire or explosion in the presence of paint or solvent fumes. All parts of the spray system, including the pump, hose assembly, spray gun, and objects in and around the spray area shall be properly grounded to protect against static discharge and sparks. Use Graco conductive or grounded high-pressure airless paint sprayer hoses.

- Verify that all containers and collection systems are grounded to prevent static discharge. Do not use pail liners unless they are anti-static or conductive.

- Connect to a grounded outlet and use grounded extensions cords. Do not use a 3-to-2 adapter.

- Do not use a paint or a solvent containing halogenated hydrocarbons.

- Do not spray combustible liquids in a confined area.

- Keep spray area well-ventilated. Keep a good supply of fresh air moving through the area.

- Sprayer generates sparks. Keep pump assembly in a well ventilated area a least 20 feet (6.1 m) from the spray area when spraying, flushing, cleaning, or servicing. Do not spray pump assembly.

- Do not smoke in the spray area or spray where sparks or flame is present.

- Do not operate light switches, engines, or similar spark producing products in the spray area.

- Keep area clean and free of paint or solvent containers, rags, and other flammable materials.

- Know the contents of the paints and solvents being sprayed. Read all Safety Data Sheets (SDSs) and container labels provided with the paints and solvents. Follow the paint and solvents manufacturer's safety instructions.

- Fire extinguisher equipment shall be present and working.



ELECTRIC SHOCK HAZARD

This equipment must be grounded. Improper grounding, setup, or usage of the system can cause electric shock.



- Turn off and disconnect power cord before servicing equipment.



- Connect only to grounded electrical outlets.

- Use only 3-wire extension cords.

- Ensure ground prongs are intact on power and extension cords.

- Do not expose to rain. Store indoors.

WARNING

	<p>SKIN INJECTION HAZARD</p> <p>High-pressure spray is able to inject toxins into the body and cause serious bodily injury. In the event that injection occurs, get immediate surgical treatment.</p> <ul style="list-style-type: none"> • Do not aim the gun at, or spray any person or animal. • Keep hands and other body parts away from the discharge. For example, do not try to stop leaks with any part of the body. • Always use the nozzle tip guard. Do not spray without nozzle tip guard in place. • Use Graco nozzle tips. • Use caution when cleaning and changing nozzle tips. In the case where the nozzle tip clogs while spraying, follow the Pressure Relief Procedure for turning off the unit and relieving the pressure before removing the nozzle tip to clean. • Equipment maintains pressure after power is shut off. Do not leave the equipment energized or under pressure while unattended. Follow the Pressure Relief Procedure when the equipment is unattended or not in use, and before servicing, cleaning, or removing parts. • Check hoses and parts for signs of damage. Replace any damaged hoses or parts. • This system is capable of producing 2800 psi. Use Graco replacement parts or accessories that are rated a minimum of 2800 psi. • Always engage the trigger lock when not spraying. Verify the trigger lock is functioning properly. • Verify that all connections are secure before operating the unit. • Know how to stop the unit and bleed pressure quickly. Be thoroughly familiar with the controls.
	<p>EQUIPMENT MISUSE HAZARD</p> <p>Misuse can cause death or serious injury.</p> <ul style="list-style-type: none"> • Always wear appropriate gloves, eye protection, and a respirator or mask when painting. • Do not operate or spray near children. Keep children away from equipment at all times. • Do not overreach or stand on an unstable support. Keep effective footing and balance at all times. • Stay alert and watch what you are doing. • Do not operate the unit when fatigued or under the influence of drugs or alcohol. • Do not kink or over-bend the hose. • Do not expose the hose to temperatures or to pressures in excess of those specified by Graco. • Do not use the hose as a strength member to pull or lift the equipment. • Do not spray with a hose shorter than 25 feet. • Do not alter or modify equipment. Alterations or modifications may void agency approvals and create safety hazards. • Make sure all equipment is rated and approved for the environment in which you are using it.
	<p>PRESSURIZED ALUMINUM PARTS HAZARD</p> <p>Use of fluids that are incompatible with aluminum in pressurized equipment can cause serious chemical reaction and equipment rupture. Failure to follow this warning can result in death, serious injury, or property damage.</p> <ul style="list-style-type: none"> • Do not use 1,1,1-trichloroethane, methylene chloride, other halogenated hydrocarbon solvents or fluids containing such solvents. • Do not use chlorine bleach. • Many other fluids may contain chemicals that can react with aluminum. Contact your material supplier for compatibility.

Warnings

WARNING



MOVING PARTS HAZARD

Moving parts can pinch, cut, or amputate fingers and other body parts.

- Keep clear of moving parts.
- Do not operate equipment with protective guards or covers removed.
- Pressurized equipment can start without warning. Before checking, moving, or servicing equipment, follow the **Pressure Relief Procedure** and disconnect all power sources.



TOXIC FLUID OR FUMES HAZARD

Toxic fluids or fumes can cause serious injury or death if splashed in the eyes or on skin, inhaled, or swallowed.

- Read MSDSs to know the specific hazards of the fluids you are using.
- Store hazardous fluid in approved containers, and dispose of it according to applicable guidelines.



PERSONAL PROTECTIVE EQUIPMENT

Wear appropriate protective equipment when in the work area to help prevent serious injury, including eye injury, hearing loss, inhalation of toxic fumes, and burns. This protective equipment includes but is not limited to:

- Protective eyewear, and hearing protection.
- Respirators, protective clothing, and gloves as recommended by the fluid and solvent manufacturer.

CALIFORNIA PROPOSITION 65

This product contains a chemical known to the State of California to cause cancer, birth defects or other reproductive harm. Wash hands after handling.

Know Your Sprayer

Stand Models

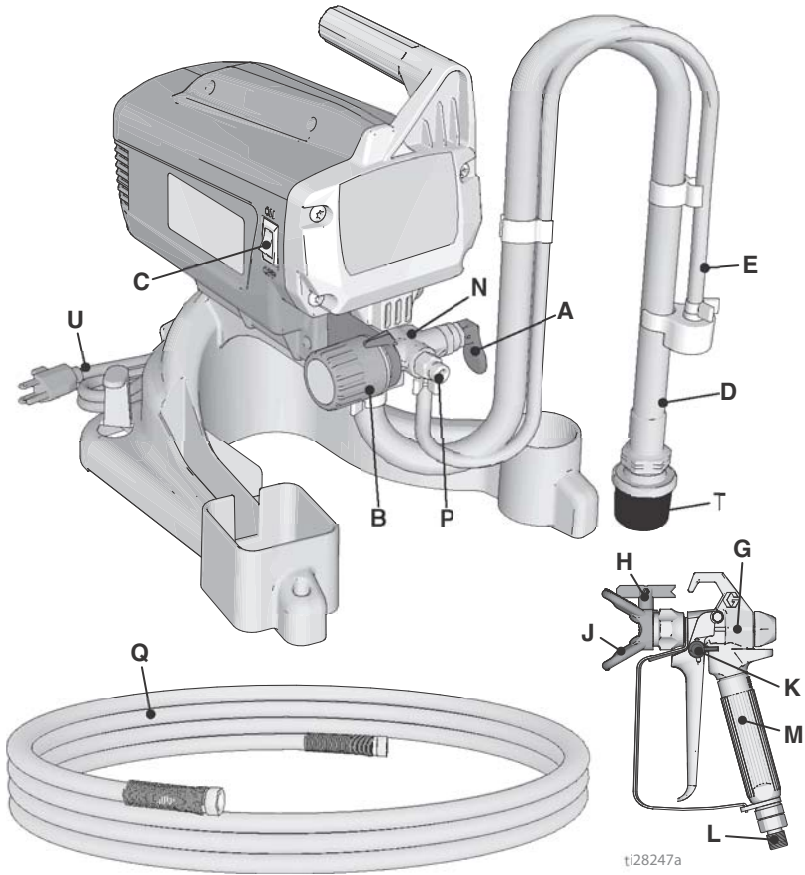

t128247a

A	Prime/Spray Valve
B	Pressure Control Knob
C	ON/OFF Switch
D	Suction Tube
E	Drain Tube (with diffuser)
G	Airless Spray Gun
H	Reversible Spray Tip
J	Tip Guard
K	Gun Trigger Lock
L	Gun Fluid Inlet Fitting

M	Gun Fluid Filter (inside handle)
N	Pump
P	Pump Fluid Outlet Fitting (airless hose connection)
Q	Airless Hose
T	Inlet Strainer
U	Power Cord
	Model/Serial Tag (Not Shown, located on bottom of unit)
See Quick Reference , page 26 for more information.	

Setup

Setup

When unpacking sprayer for the first time or after long term storage perform setup procedure.

Assemble Your Sprayer

1. Connect Graco airless hose to fluid outlet. Use wrench to tighten securely.

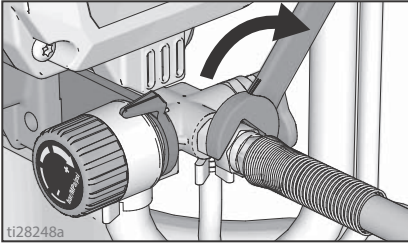

2. Connect other end of hose to gun.

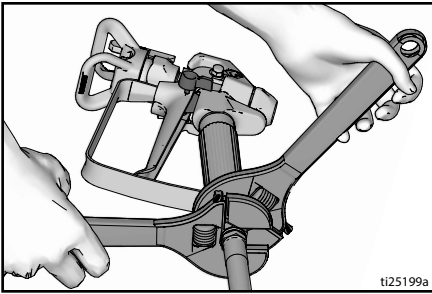

3. Use two wrenches to tighten securely. If hose is already connected, make sure connections are tight.
4. Engage trigger lock.

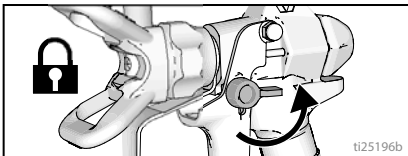

5. Remove tip guard. Be careful tip seal may fall out when tip guard is removed.

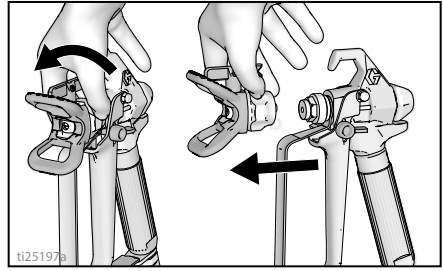

6. Turn pressure control knob all the way left (counter-clockwise) to lowest setting.

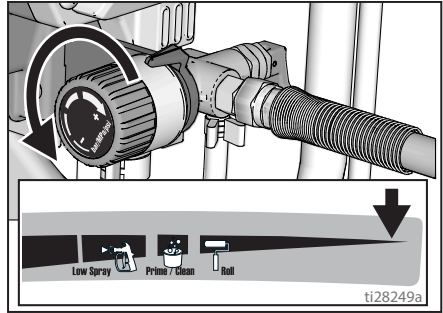

7. After long term storage check inlet strainer for clogs and debris.

Strain the Paint

Previously opened paint may contain dried paint or other debris. To avoid priming problems and spray tip clogs it is recommended to strain the paint before using. Paint strainers are available where paint is sold. Stretch a paint strainer over a clean pail and pour the paint through the strainer to capture any dried paint and debris before spraying.



Start Up



Pressure Relief Procedure



Follow the Pressure Relief Procedure whenever you see this symbol.

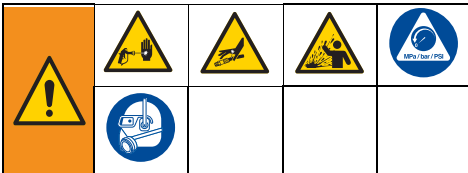

This equipment stays pressurized until pressure is manually relieved. To help prevent serious injury from pressurized fluid, such as skin injection or splashed fluid, follow the **Pressure Relief Procedure** whenever sprayer is stopped and before sprayer is cleaned or checked, and before equipment is serviced.

1. Turn ON/OFF switch to the **OFF** position.

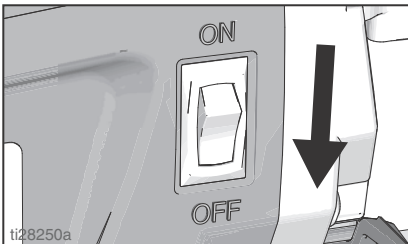

2. Engage the trigger lock. Always engage the trigger lock when sprayer is stopped to prevent the gun from being triggered accidentally.

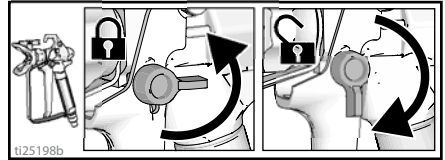

3. Turn pressure control knob to lowest setting.

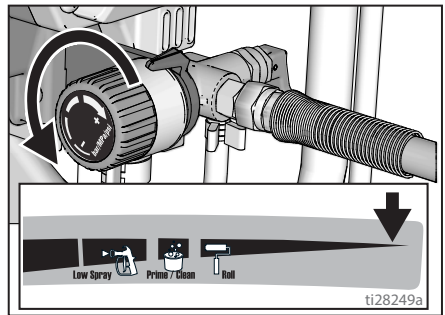

4. Put drain tube into a waste pail and lift Prime/Spray valve to PRIME position (drain) to relieve pressure.

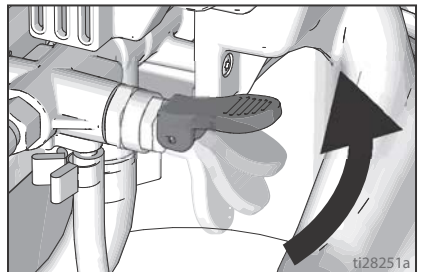

5. Hold the gun firmly to a pail. Point gun into pail. Disengage the trigger lock and trigger the gun to relieve pressure.

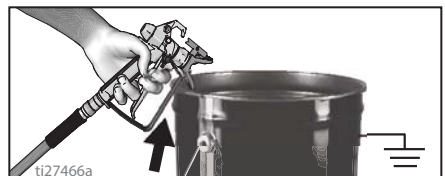

Start Up

6. Engage the trigger lock.
7. If you suspect the spray tip or hose is clogged or that pressure has not been fully relieved:
 - a. **VERY SLOWLY** loosen the tip guard retaining nut or the hose end coupling to relieve pressure gradually.
 - b. Loosen the nut or coupling completely.
 - c. Clear airless hose or spray tip obstruction. See **Clear Tip Clog**, page 16.

Flush Storage Fluid

This sprayer arrives from the factory with a small amount of test material in the system. **It is important that you flush this material from the sprayer before using it for the first time.** See **Cleaning Fluid Compatibility**, page 24 and **Static Grounding Instructions (Oil-Based materials)**, page 24 for additional information when using oil-based materials.

1. Perform **Pressure Relief Procedure**, page 11.
2. Make certain ON/OFF switch is **OFF**.
3. Separate drain tube (smaller) from suction tube (larger).
4. Place drain tube in a waste pail.
5. Submerge suction tube in a pail partially filled with water or flushing fluid. If spraying oil-based materials, submerge the suction tube in mineral spirits, or compatible cleaning solvent. If spraying water-based materials, submerge the suction tube in water.

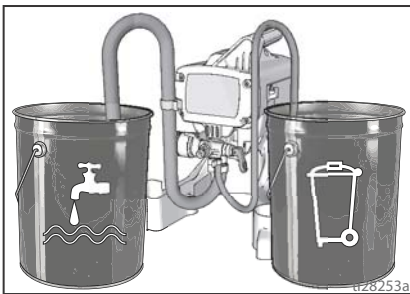

6. Lift Prime/Spray valve to PRIME position.

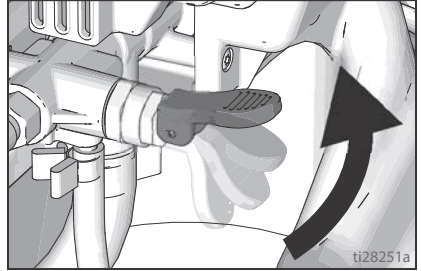

7. Plug power supply cord into a properly grounded electrical outlet.
8. Align setting indicator with Prime/Clean setting on pressure control knob.

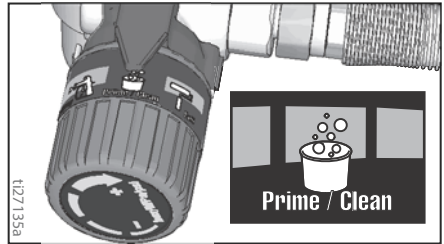

9. Turn ON/OFF switch to **ON** position.

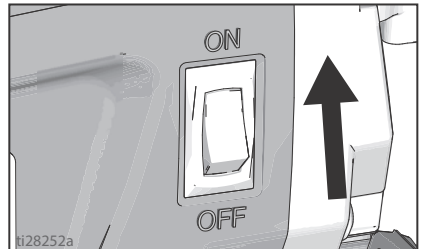

- When sprayer starts pumping, flushing solvent and air bubbles will be purged from system. Allow fluid to flow out of drain tube, into waste pail, for 30 to 60 seconds.
- Turn ON/OFF switch to **OFF** position.



High-pressure spray is able to inject toxins into the body and cause serious bodily injury. Do not stop leaks with hand or rag.

- Inspect for leaks. If leaks occur, perform **Pressure Relief Procedure**, page 11, then tighten all fittings and repeat **Start Up**. If there are no leaks continue with the next step.

Fill Pump

- Move suction tube to paint pail and submerge suction tube in paint.

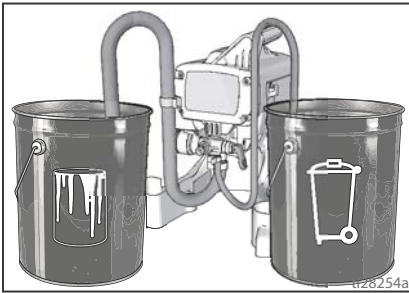

- Turn ON/OFF switch to **ON** position.
- Wait to see paint coming out of drain tube.
- Turn ON/OFF switch to **OFF** position.

NOTE: Some fluids may prime faster if the ON/OFF Switch is momentarily turned off so the pump can slow and stop. Turn ON/OFF switch on and off several times if necessary.

Fill Gun and Hose

- Hold gun against waste pail. Point gun into waste pail.
 - Disengage trigger lock.
 - Pull and hold gun trigger.
 - Lower Prime/Spray valve to **SPRAY** position.
 - Turn ON/OFF switch to **ON** position.

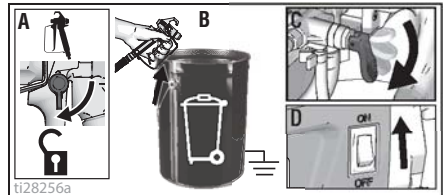

- Trigger gun into waste pail until only paint comes out of the gun.
- Release trigger. Engage trigger lock.
- Transfer drain tube to paint pail and clip to suction tube.

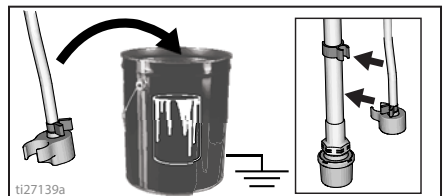

NOTE: When motor stops, sprayer is ready to paint. If motor continues to run, sprayer is not properly primed. Repeat **Fill Pump** and **Fill Gun and Hose**.

How to Spray

How to Spray

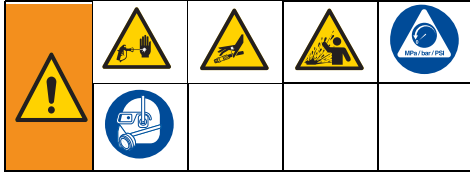

Spray Tip Installation

To prevent spray tip leaks make certain spray tip and tip guard are installed properly.

1. Perform **Pressure Relief Procedure**, page 11.
2. Engage trigger lock.
3. Verify spray tip and tip guard parts are assembled in the order shown.

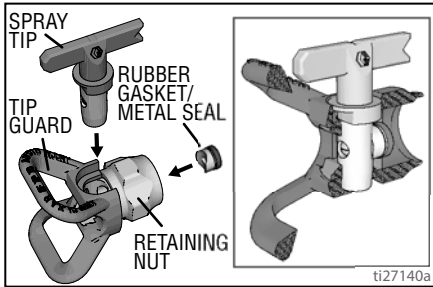

- a. Use spray tip to align gasket and seal in the tip guard.

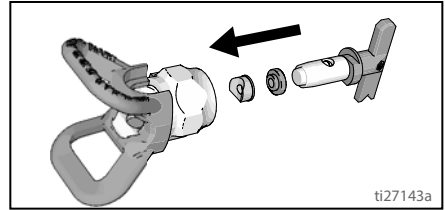

- b. Spray tip must be pushed all the way into the tip guard. Turn spray tip to push down.

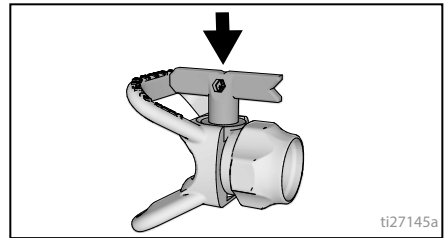

- c. Turn the arrow shaped handle on the spray tip forward to the spray position.
4. Screw spray tip and tip guard assembly onto the gun and tighten.

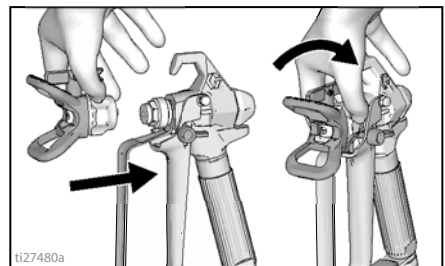

Adjust Pressure Control

The pressure control knob allows for infinite pressure adjustment. To reduce overspray, always start at the lowest pressure setting and increase pressure to the minimum setting that results in an acceptable spray pattern.



To select function, align symbol on pressure control knob with setting indicator on sprayer.

Tip and Pressure Selection

See table for recommended spray pressure for your material. Refer to paint (material) can for manufacturer's recommendations.

Maximum tip hole size supported by the sprayer: 0.015 in. (0.38mm)

	Coatings				
	Interior Stains/ Interior & Exterior Clears	Exterior Solid Stains	Primers	Interior Latex Paints	Exterior Latex Paints
Spray Pressure	Low Spray	High Spray	High spray	High Spray	High Spray
Tip hole Size					
0.011 in. (0.28 mm)	✓				
0.013 in. (0.33 mm)	✓	✓	✓	✓	
0.015 in. (0.38 mm)		✓	✓	✓	✓

Spray Techniques

Use a piece of scrap cardboard to practice these basic spraying techniques before you begin spraying the surface.

- Hold gun 12 in. (30 cm) from surface and aim straight at surface. Tilting gun to direct spray angle causes an uneven finish.
- Flexing wrist to keep gun pointed straight. Fanning gun to direct spray at angle causes uneven finish.

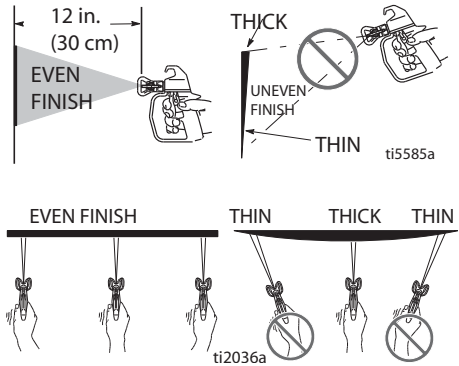

How to Spray

Triggering Gun

Pull trigger after starting stroke. Release trigger before end of stroke. Gun must be moving when trigger is pulled and released.

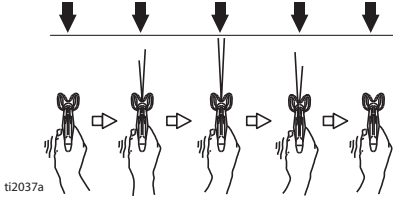

Aiming Gun

Aim center of spray of gun at bottom edge of previous stroke, overlapping each stroke by half.

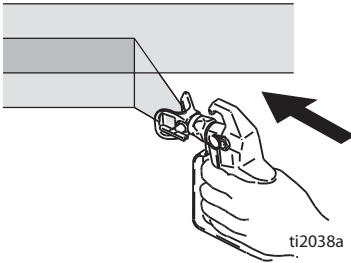

Spray Pattern Quality

A good spray pattern is evenly distributed as it hits the surface.

- Spray should be atomized (evenly distributed, no gaps at edges).

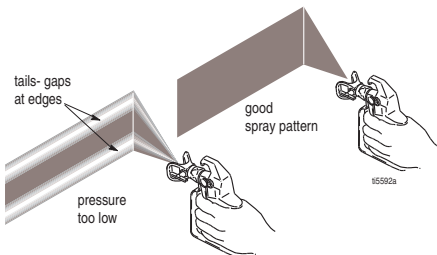

If tails persist when spraying at the highest spray pressure:

- Spray tip may be worn. See **Tip and Pressure Selection**, page 15.

- A smaller spray tip may be needed.
- Material may need to be thinned. If material needs to be thinned follow manufacturer's recommendations.

Clear Tip Clog

In the event that particles or debris clog the spray tip, this sprayer is designed with a reversible spray tip that quickly and easily clears the particles without disassembling the sprayer.

See **Strain the Paint**, page 10 for additional information.

1. Engage trigger lock. Rotate spray tip to unplug position. Disengage trigger lock. Trigger gun at waste area to clear clog.

UNCLOG

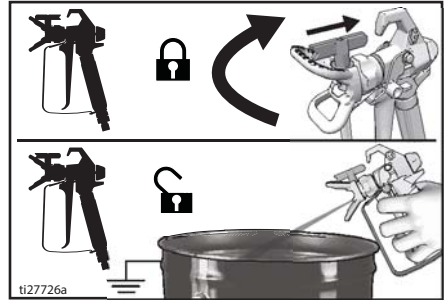

NOTE: If spray tip is difficult to rotate when turning to the unplug position perform, **Pressure Relief Procedure**, page 11, then lower Prime/Spray valve to spray position and repeat step 1.

2. Engage trigger lock. Rotate spray tip back to spray position. Disengage trigger lock and continue spraying.

SPRAY

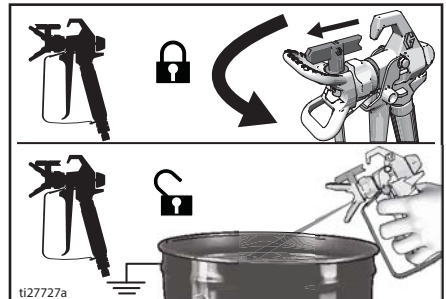

Cleanup

Cleaning the sprayer after each use results in a trouble free start up the next time the sprayer is used.

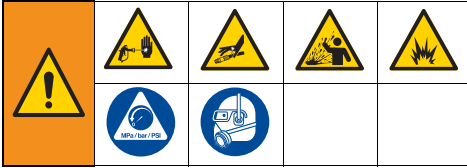

Cleaning from a Pail

- For short term shutdown periods (overnight to two days) refer to **Short Term Storage**, page 21.
 - See **Cleaning Fluid Compatibility**, page 24 for information on flushing/cleaning fluids and **Static Grounding Instructions (Oil-Based materials)**, page 24.
1. Perform **Pressure Relief Procedure**, page 11.
 2. Remove spray tip and tip guard assembly from gun and place in waste pail.

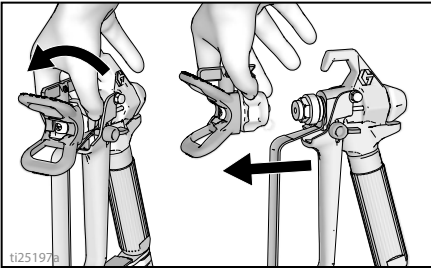

3. Lift suction tube and drain tube from paint pail. Let paint drain into the pail.
4. Separate drain tube (smaller) from suction tube (larger).

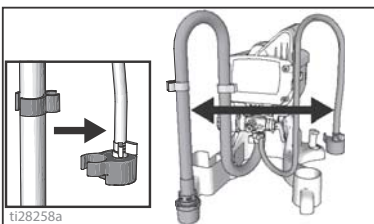

5. Place empty waste and flushing fluid pails side by side.
6. Place suction tube in flushing fluid. Use water for water based paint and mineral spirits or compatible oil-based flushing solvent for oil-based paint. Place drain tube in waste pail.

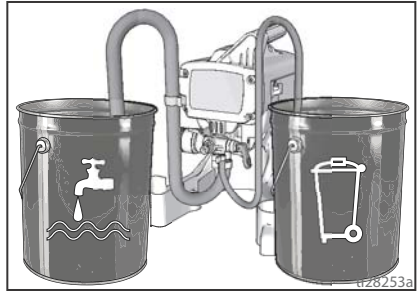

7. Turn pressure control knob to the Prime/Clean setting.

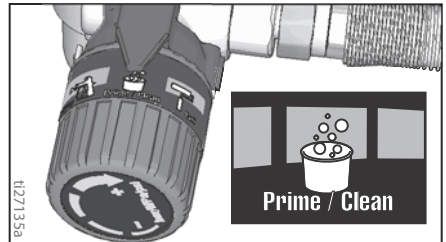

8. Lift Prime/Spray valve to PRIME position.

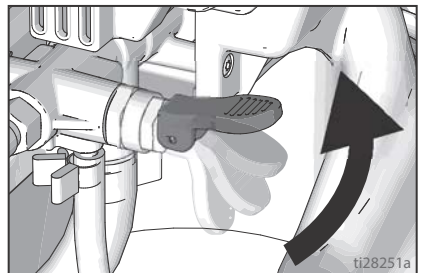

9. Turn ON/OFF switch to **ON** position.
10. Flush until approximately 1/3 of the flushing fluid is emptied from the pail.

Cleanup

11. Turn ON/OFF switch to **OFF** position.

NOTE: Step 12 is for returning paint in hose to paint pail. One 50 ft (15 m) hose holds approximately 1 quart (1 liter) of paint.

12. To recover paint in hose, point gun into paint pail while holding gun firmly to the pail.
 - a. Disengage trigger lock.
 - b. Pull and hold gun trigger.
 - c. Lower Prime/Spray valve to **SPRAY** position.
 - d. Turn ON/OFF switch to **ON** position.
 - e. Continue to hold gun trigger until you see paint diluted with flushing fluid starting to come out of gun.

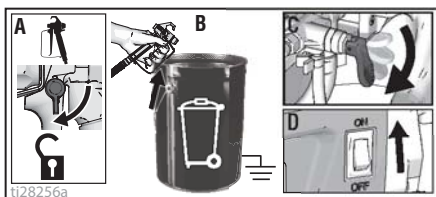

13. While continuing to trigger gun, quickly move gun to redirect spray into waste pail. Continue triggering gun into waste pail until flushing fluid dispensed from gun is relatively clear.

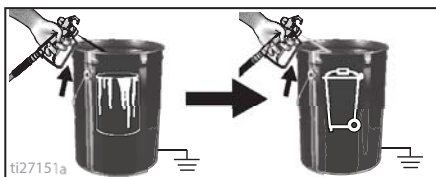

14. Turn pressure control knob to the lowest setting.
15. Stop triggering gun. Engage the trigger lock.

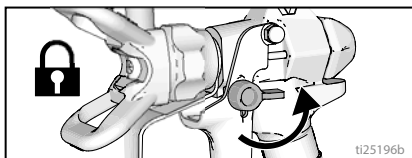

16. Lift Prime/Spray valve to **PRIME** position.
17. Turn ON/OFF switch to **OFF** position.
18. Clean outlet filter.
19. Fill unit with Pump Armor™ fluid. See **Long Term Storage**, page 21.

Cleanup with Power Flush Adapter

(Water-based materials only)

Power flushing is a faster method of cleanup. It can only be used after spraying water-based coatings.

1. Perform **Pressure Relief Procedure**, page 11.
2. Remove spray tip and tip guard assembly from gun and place in waste pail.

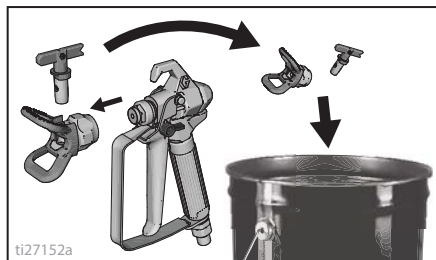

3. Place empty waste and paint pails side by side.
4. Lift suction tube and drain tube from paint pail. Let paint drain into the pail.
5. Place suction and drain tube in waste pail.

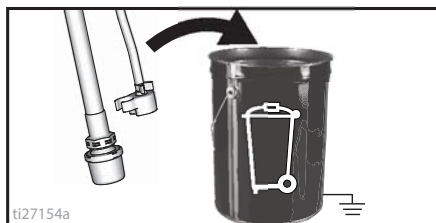

- Turn pressure control knob to the Prime/Clean setting.

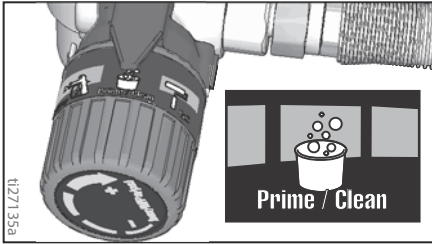

- Screw Power Flush attachment valve to garden hose. Close valve.

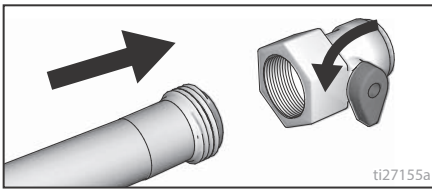

- Turn on water. Open valve. Rinse paint off suction tube, drain tube and inlet strainer. Close valve.

- Unscrew inlet strainer from suction tube. Place inlet strainer in waste pail.

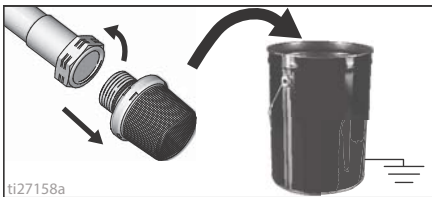

- Connect garden hose to suction tube with Power Flush attachment valve. Leave drain tube in waste pail.

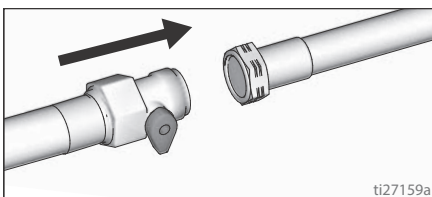

- Turn ON/OFF switch to **ON** position.
- Open Power Flush attachment valve.
- Circulate water through sprayer, into waste pail, for 20 seconds.
- Turn ON/OFF switch to **OFF** position.

NOTE: Step 15 is for returning paint in hose to paint pail. One 50 ft (15 m) hose holds approximately 1 quart (1 liter) of paint.

- To recover paint in hose, point gun to paint pail while holding gun firmly to the pail.
 - Disengage trigger lock.
 - Pull and hold gun trigger.
 - Lower Prime/Spray valve to **SPRAY** position.
 - Turn ON/OFF switch to **ON** position.
 - Continue to hold gun trigger until you see paint diluted with flushing fluid starting to come out of gun.

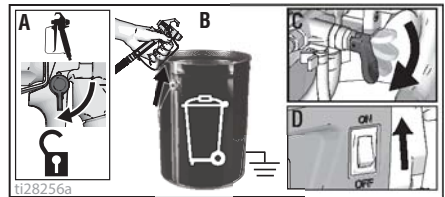

- While continuing to trigger gun, quickly move gun to redirect spray into waste pail. Continue triggering gun into waste pail until flushing fluid dispensed from gun is relatively clear.

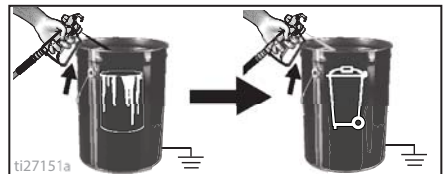

- Turn pressure control knob to the lowest setting.
- Stop triggering gun. Engage the trigger lock.

Cleanup

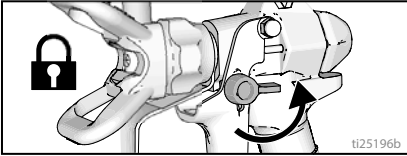

19. Lift Prime/Spray valve to PRIME position.

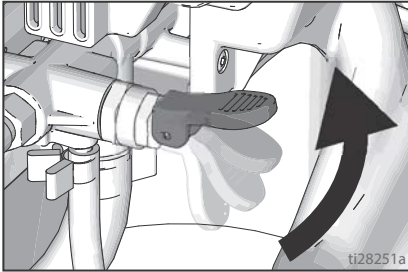

20. Turn ON/OFF switch to **OFF** position.

Clean the Gun

1. Clean gun fluid filter with water or flushing fluid and a brush every time you flush the system. Replace gun filter if damaged.

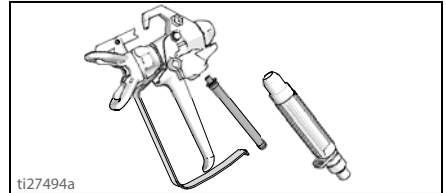

2. Remove spray tip and tip guard and clean with water or flushing fluid and a brush.

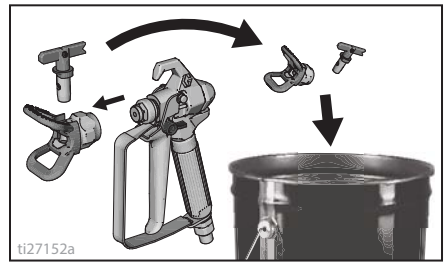

3. Wipe paint off outside of gun using a soft cloth moistened with water or flushing fluid.

Storage

With proper storage, the sprayer will be ready to use the next time it is needed.

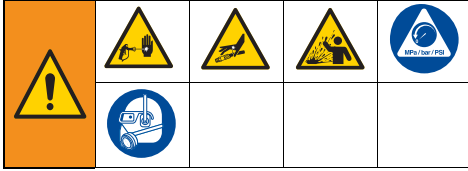

Short Term Storage

(up to 2 days)

1. Perform **Pressure Relief Procedure**, page 11.
2. Leave suction tube and drain tube in paint pail.

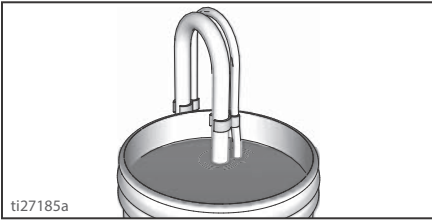

3. Cover paint and pail tightly with plastic wrap.

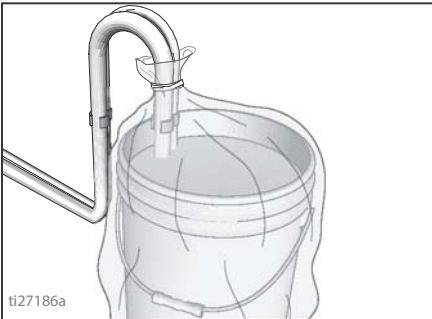

4. Engage trigger lock.

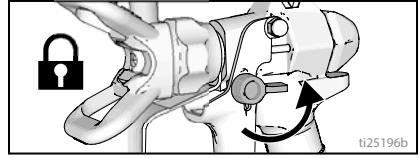

5. Leave gun attached to hose.
6. Remove tip and guard and clean with water or flushing fluid and a brush.
7. Wipe paint off outside of gun using a soft cloth moistened with water or flushing fluid.

Long Term Storage

(more than 2 days)

Pump Armor fluid protects the sprayer against freezing and corrosion.

- Before storing sprayer make sure all water is drained out of sprayer.
 - Do not allow water to freeze in sprayer.
 - Do not store sprayer under pressure.
 - Store sprayer indoors.
1. Perform **Pressure Relief Procedure**, page 11.
 2. Place suction tube in Pump Armor fluid bottle and drain tube in waste pail.

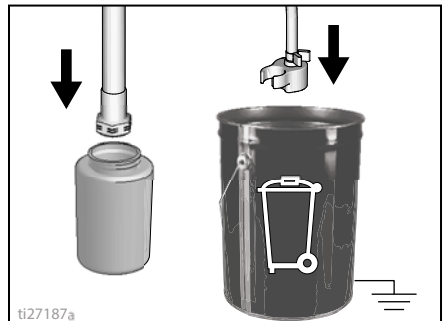

Storage

3. Lift Prime/Spray valve to PRIME position.

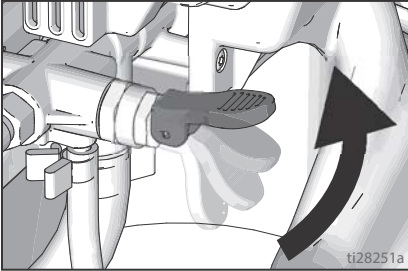

4. Turn ON/OFF switch to **ON** position.
5. Turn pressure control knob clockwise until the pump turns on.
6. When storage fluid comes out of drain tube (5-10 seconds) turn ON/OFF switch to **OFF** position.
7. Lower Prime/Spray valve to **SPRAY** position to keep storage fluid in sprayer during storage.

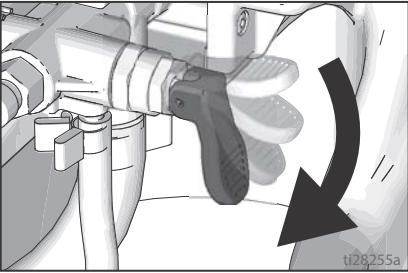

8. Leave gun attached to hose.
9. Remove tip and guard and clean with water or flushing fluid and a brush.
10. Wipe paint off outside of gun using a soft cloth moistened with water or flushing fluid.

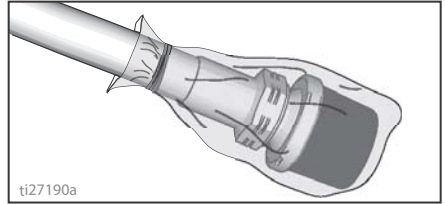

11. Secure a plastic bag around suction and drain tube to catch any drips.

Reference

Spray Tip Selection

Selecting Tip Size

Spray tips come in a variety of hole sizes for spraying a range of fluids. Your sprayer includes a tip for use in most paint spraying applications. Use the coatings table on page 15 to determine the range of recommended tip hole sizes for each fluid type. If you need a tip other than the one supplied, see the **Reversible Spray Tip Selection Chart**, page 23.

Hints:

- As you spray, the tip wears and enlarges. Starting with a tip hole size smaller than the maximum will allow you to spray within the rated flow capacity of the sprayer.
- Use larger tip hole sizes with thicker coatings and smaller tip hole sizes with thinner coatings.
- Tips wear with use and need periodic replacement.
- Tip hole size controls flow rate - the amount of paint that comes out of the gun.

Fan Width

Fan width is the size of the spray pattern, which determines the area covered with each stroke.

Hints:

- Select a fan width best suited to the surface being sprayed.
- Wider fans allow provide better coverage on broad, open surfaces.
- Narrower fans provide better control on small, confined surfaces.

Understanding Tip Number

The last three digits of tip number (i.e.: 221413) contain information about hole size and fan width on surface when gun is held 12 in. (30.5 cm) from surface being sprayed.

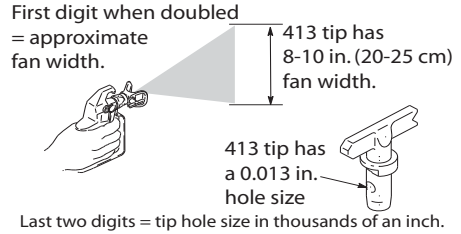

Reversible Spray Tip Selection Chart

Tip Part #	Fan Width *	Hole Size
221311	6 - 8 in. (152 - 203 mm)	0.011 in. (0.28 mm)
221411	8 - 10 in. (203 - 254 mm)	0.011 in. (0.28 mm)
221313	6 - 8 in. (152 - 203 mm)	0.013 in. (0.33 mm)
221413	8 - 10 in. (203 - 254 mm)	0.013 in. (0.33 mm)
221415	8 - 10 in. (203 - 254 mm)	0.015 in. (0.38 mm)
221515	10 - 12 in. (254 - 305 mm)	0.015 in. (0.38 mm)
* - 12 in. (305 mm) from surface		

Example: For an 8 to 10 in. (203 to 254 mm) fan width and 0.013 (0.33 mm) hole size, order Part No. 221413.

Cleaning Fluid Compatibility

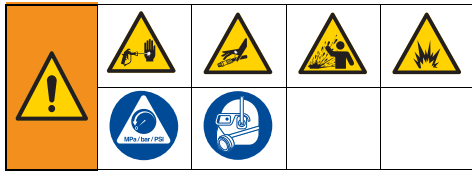

Oil- or Water-Based Materials

- When spraying **water-based** materials, flush the system thoroughly with water.
- When spraying **oil-based** materials, flush the system thoroughly with mineral spirits or compatible, oil-based flushing solvent.
- To spray **water-based** materials **after spraying oil-based** materials, flush the system thoroughly with water first. The water flowing out of drain tube should be clear and solvent-free **before** you begin spraying the water-based material.
- To spray **oil-based** materials **after spraying water-based** materials, flush the system thoroughly with mineral spirits or a compatible oil-based flushing solvent first. The solvent flowing out of the drain tube should not contain any water. When flushing with solvents always follow **Static Grounding Instructions (Oil-Based materials)**, page 24.
- To avoid fluid splashing back on your skin or into your eyes, always aim gun at inside wall of pail.

Static Grounding Instructions (Oil-Based materials)



The equipment must be grounded to reduce the risk of static sparking and electric shock. An electric or static spark can cause fumes to ignite or explode. An improper ground can cause electric shock. A good ground provides an escape wire for the electric current.

Always use a metal pail for oil-based materials requiring flushing with compatible oil-based flushing solvents when sprayer is flushed or pressure is relieved.

Follow local code. Use only conductive metal pails, placed on a grounded surface such as concrete.

Do not place pail on a non-conductive surface such as paper or cardboard which interrupts grounding continuity.

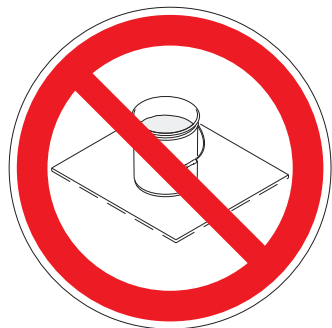

Always ground a metal pail: connect a ground wire to the pail. Clamp one end to the pail and the other end to a true earth ground such as a water pipe.

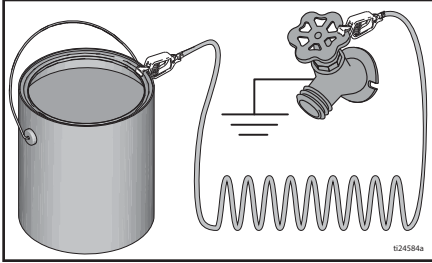

To maintain ground continuity when sprayer is flushed or pressure is relieved: hold metal part of spray gun firmly to the side of a grounded metal pail, then trigger the gun.

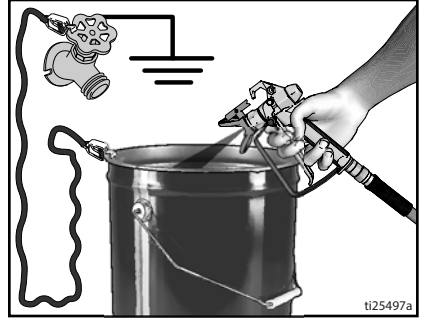

Quick Reference

Page 9	Name	Description
A	Prime/Spray valve	<ul style="list-style-type: none">• In PRIME position directs fluid to prime tube.• In SPRAY position directs pressurized fluid to paint hose.• Automatically relieves system pressure in over-pressure situations.
B	Pressure control knob	Increases (clockwise) and decreases (counter-clockwise) fluid pressure in pump, hose, and spray gun.
C	ON/OFF Switch	Turns sprayer ON and OFF.
D	Suction tube	Draws fluid from paint pail into pump.
E	Drain tube (with diffuser)	Drains fluid in system during priming and pressure relief.
G	Airless spray gun	Dispenses fluid.
H	Reversible spray tip	<ul style="list-style-type: none">• Atomizes fluid being sprayed, forms spray pattern and controls fluid flow according to hole size.• Reverse unclogs plugged tips without disassembly.
J	Tip guard	Reduces risk of fluid injection injury.
K	Gun trigger lock	Prevents accidental triggering of spray gun.
L	Gun fluid inlet fitting	Threaded connection for paint hose.
M	Gun fluid filter (inside handle)	Filters fluid entering spray gun to reduce tip clogs.
N	Pump	Pumps and pressurizes fluid and delivers it to paint hose.
P	Pump fluid outlet fitting (airless hose connection)	Threaded connection for paint hose.
Q	Airless hose	Transports high-pressure fluid from pump to spray gun.
T	Inlet strainer	Prevents debris from entering pump.
U	Power cord	Supplies Project Painter Plus with electricity.

Maintenance

Routine maintenance is important to ensure proper operation of your sprayer.



Activity	Interval
Inspect motor shroud openings for blockage.	Daily or each time you spray
Inspect/clean fluid inlet strainer and gun filter.	Daily or each time you spray

NOTICE

Protect the internal drive parts of this sprayer from water. Openings in shroud allow cooling of mechanical parts and electronics inside. If water gets into these openings, the sprayer could malfunction or be permanently damaged.

Spray Tips

- Always clean tips with compatible cleaning fluid and brush after spraying.
- Tips may require replacement after 15 gallons (57 liters) or they may last through 60 gallons (227 liters) depending on abrasiveness of paint.

Airless Hoses

Check hose for damage every time you spray. Do not attempt to repair hose if hose jacket or fittings are damaged. Do not use hoses shorter than 25 ft (7.6 m). Wrench tighten, using two wrenches.

Troubleshooting

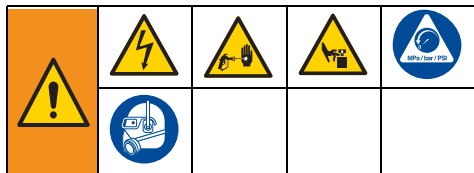

1. Follow **Pressure Relief Procedure**, page 11, before checking or repairing.
2. Solutions at the beginning of each problem listed are the most common.

3. Check everything in this Troubleshooting Table before you bring the sprayer to an authorized service center.

Have a Question?

Call toll-free:
1-888-541-9788
 Or visit us at:
www.magnum.graco.com

t124021a

Problem	Cause	Solution
Motor does not run: (verify sprayer is plugged in, and ON/OFF switch is on)	Pressure control is set at zero pressure.	Turn pressure control knob clockwise to increase pressure setting.
	Electric outlet is not providing power.	Test outlet with known working device. Find working outlet. Reset building circuit breaker or replace fuse.
	Extension cord is damaged.	Replace extension cord. See page 5.
	Sprayer electric cord is damaged.	Check for broken insulation or wires. Replace electric cord if damaged.
	Pump is seized (Paint has hardened in pump or Water is frozen in pump.)	Turn ON/OFF switch off and unplug sprayer from outlet. If frozen do NOT try to start sprayer until it is completely thawed or it may damage the motor, control board and/or drive train. Place sprayer in warm area for several hours. Plug in power cord and turn ON/OFF switch to ON. Slowly increase pressure setting to see if motor will start. If not frozen, check for hardened paint in pump. If paint has hardened in pump. See page 29.
	Motor or control is damaged.	Consult a Graco/ Magnum authorized retailer, distributor, or service center.

Problem	Cause	Solution
Sprayer runs, but pump does not prime or loses prime while in use. (Pump cycles but does not pump paint or build pressure.)	Inlet valve check ball is stuck.	Remove suction tube and place a pencil into the inlet section to dislodge the ball, allowing pump to prime properly, OR Power Flush Sprayer, page 18.
	Prime/Spray valve is in SPRAY position.	Lift Prime/Spray valve to PRIME position until paint exits drain tube. The pump is now primed.
	Pump was not primed with flushing fluid. (Thick fluids may not prime if not initially primed with flushing fluid.)	Remove suction tube from paint. Prime pump with oil or water-based flushing fluid. See page 24.
	Debris in paint.	Strain the paint. See page 10.
	Thick or "sticky" paint.	Some fluids may prime faster if the ON/OFF switch is momentarily turned off so the pump can slow and stop. Turn ON/OFF switch on and off several times if necessary.
	Inlet strainer is clogged or suction tube is not immersed in paint.	Clean debris off inlet strainer and make sure suction tube is immersed in paint.
	Inlet valve check ball or seat is dirty.	Remove inlet fitting. Clean and reinstall ball and seat.
	Suction tube is leaking.	Inspect suction tube connection for cracks or vacuum leaks.
	Outlet valve check ball is stuck.	Unscrew outlet valve, remove, and clean assembly.
Prime/Spray valve is worn or obstructed with debris.	Take sprayer to Graco/MAGNUM authorized service center.	

Troubleshooting

Problem	Cause	Solution
Pump is primed, but can not achieve good spray pattern.	Spray tip may be partially clogged.	Clear spray tip clog. See page 16.
	Reversible spray tip is in UNCLOG position.	Rotate arrow-shaped handle on spray tip so it points forward to SPRAY position. See page 16.
	Debris in paint.	Strain the paint. See page 24.
	Pressure is set too low.	Align pressure control knob setting indicator to desired spray setting. See page 15.
	Spray gun fluid filter is clogged.	Clean or replace gun fluid filter. See page 20.
	Spray tip selected is too large for capability of sprayer.	Replace tip. See page 15.
	Spray tip is worn beyond the capability of sprayer.	Replace tip. See page 15.
	Spray tip gasket and seal worn or missing.	Replace gasket and seal. See page 14.
	Inlet strainer is clogged or suction tube is not immersed in paint.	Clean debris off inlet strainer and make sure suction tube is immersed in paint.
	Extension cord is too long or not heavy enough gauge.	Replace extension cord. See page 5.
	Inlet pump valve or outlet pump valve is worn or clogged with debris.	Check for worn or contaminated inlet valve or outlet valve. <ul style="list-style-type: none"> - Prime sprayer with paint - Trigger gun momentarily - When trigger is released, pump should cycle momentarily and stop - If pump continues to cycle, pump valves may be worn or contaminated with debris - Remove valves. Clean and reinstall valve assemblies.
	Material is too thick.	Thin material. Follow manufacturers recommendations.
Airless hose is too long (if extra section was added).	Remove section of airless hose.	
Spray gun stopped spraying while trigger is pulled.	Spray tip is clogged.	Clear spray tip clog. See page 16.
	Sprayer lost prime.	See troubleshooting section "Sprayer runs, but pump does not prime or loses prime while in use." on page 29.

Problem	Cause	Solution
When paint is sprayed, it runs down the wall or sags.	Material is going on too thick.	Move gun faster.
		Choose a spray tip with smaller hole size.
		Choose spray tip with wider fan.
		Make sure gun is far enough from surface.
When paint is sprayed, coverage is inadequate.	Material is going on too thin.	Move gun slower.
		Choose spray tip with larger hole size.
		Choose spray tip with narrower fan.
		Make sure gun is close enough to surface.
Fan pattern varies dramatically while spraying.	Pressure control switch is worn and causing excessive pressure variation.	Take sprayer to Graco/MAGNUM authorized service center.
Cannot trigger spray gun.	Spray gun trigger lock is engaged.	Rotate trigger lock to disengage trigger lock. See page 10.
Paint is coming out of pressure control switch.	Pressure control switch is worn.	Take sprayer to Graco/MAGNUM authorized service center.
Paint is leaking through drain tube.	Sprayer is over pressurizing.	Take sprayer to Graco/MAGNUM authorized service center.
Paint leaks down outside of pump.	Pump packings are worn.	Replace sprayer.
Motor is hot and runs intermittently. Motor automatically shuts off due to excessive heat. Damage can occur if cause is not corrected.	Vent holes in enclosure are plugged or sprayer is covered.	Keep vent holes clear of obstructions and overspray and keep sprayer open to air.
	Extension cord is too long or not a heavy enough gauge.	Replace extension cord. See page 5.
	Unregulated electrical generator being used has excessive voltage.	Use electrical generator with a proper voltage regulator.
	Sprayer was operated at high pressure with very small tip, which causes frequent motor starts and excessive heat build up.	Decrease pressure setting or increase tip size.

Project Painter Plus: 257025 Sprayer Parts

Project Painter Plus: 257025 Sprayer Parts



Ref. Part	Description	Qty.	Ref. Part	Description	Qty.
1	197607 KIT, suction tube	1	17K631	TAG, hang, tip (not shown)	1
2	243011 GUN, SG2	1	17K516	LABEL, A+ Service (not shown)	1
3	24D616 KIT, enclosure and stand	1	▲ 17K627	LABEL, warning (not shown)	1
4	244035 DEFLECTOR, barbed	1	▲ 179960	CARD, medical wallet (not shown)	1
5	288716 STRAINER	1			
6	24D617 KIT, front cover	1			
7	247339 HOSE, 1/4 in. x 25 ft	1			

▲ Replacement Danger and Warning labels, tags, and cards are available at no cost.

Wiring Diagram

110/120V

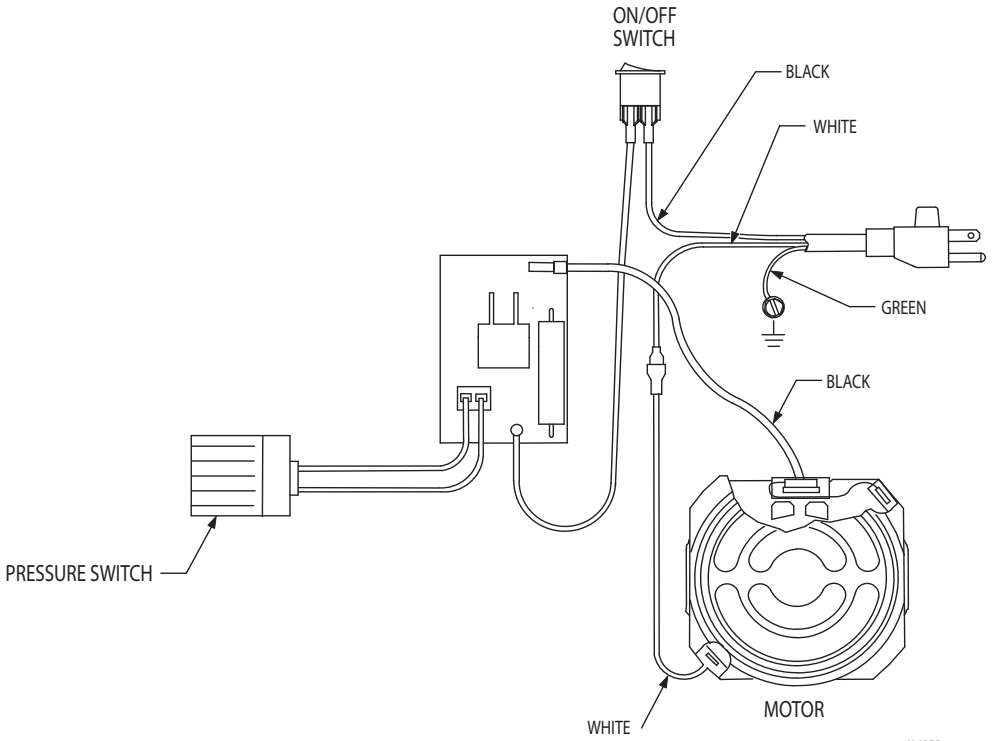

Technical Specifications

Technical Specifications

	US	Metric
Sprayer		
Maximum fluid working pressure	2800 psi	19.3 MPa, 193 bar
Maximum delivery	0.24 gpm	0.91 lpm
Maximum tip size	0.015 in.	0.38 mm
Generator minimum	1500 W	
Power requirement	120 Vac, 60 Hz, 7A, 1 phase	
Dimensions		
Height	13.8 in.	35.1 cm
Length	13.8 in.	35.1 cm
Width	12.1 in.	30.7 cm
Weight (sprayer, hose & gun)	13.2 lb	5.9 kg
Storage temperature range ♦❖	-30° to 160°F	-35° to 71°C
Operating temperature range ✓	40° to 115°F	4° to 46°C
Materials of Construction		
Wetted materials on all models	stainless steel, brass, leather, ultra-high molecular weight polyethylene (UHMWPE), carbide, nylon, aluminum, PVC, polypropylene, fluoroelastomer, plated steel	

- ◆ **When pump is stored with non-freezing fluid. Pump damage will occur if water or latex paint freezes in pump.**
- ❖ Damage to plastic parts may result if impact occurs in low temperature conditions.
- ✓ Changes in paint viscosity at very low or very high temperatures can affect sprayer performance.

Graco Standard Warranty

Graco warrants all equipment referenced in this document which is manufactured by Graco and bearing its name to be free from defects in material and workmanship on the date of sale to the original purchaser for use. With the exception of any special, extended, or limited warranty published by Graco, Graco will, for a period of twelve months from the date of sale, repair or replace any part of the equipment determined by Graco to be defective. This warranty applies only when the equipment is installed, operated and maintained in accordance with Graco's written recommendations.

This warranty does not cover, and Graco shall not be liable for general wear and tear, or any malfunction, damage or wear caused by faulty installation, misapplication, abrasion, corrosion, inadequate or improper maintenance, negligence, accident, tampering, or substitution of non-Graco component parts. Nor shall Graco be liable for malfunction, damage or wear caused by the incompatibility of Graco equipment with structures, accessories, equipment or materials not supplied by Graco, or the improper design, manufacture, installation, operation or maintenance of structures, accessories, equipment or materials not supplied by Graco.

This warranty is conditioned upon the prepaid return of the equipment claimed to be defective to an authorized Graco distributor for verification of the claimed defect. If the claimed defect is verified, Graco will repair or replace free of charge any defective parts. The equipment will be returned to the original purchaser transportation prepaid. If inspection of the equipment does not disclose any defect in material or workmanship, repairs will be made at a reasonable charge, which charges may include the costs of parts, labor, and transportation.

THIS WARRANTY IS EXCLUSIVE, AND IS IN LIEU OF ANY OTHER WARRANTIES, EXPRESS OR IMPLIED, INCLUDING BUT NOT LIMITED TO WARRANTY OF MERCHANTABILITY OR WARRANTY OF FITNESS FOR A PARTICULAR PURPOSE.

Graco's sole obligation and buyer's sole remedy for any breach of warranty shall be as set forth above. The buyer agrees that no other remedy (including, but not limited to, incidental or consequential damages for lost profits, lost sales, injury to person or property, or any other incidental or consequential loss) shall be available. Any action for breach of warranty must be brought within two (2) years of the date of sale.

GRACO MAKES NO WARRANTY, AND DISCLAIMS ALL IMPLIED WARRANTIES OF MERCHANTABILITY AND FITNESS FOR A PARTICULAR PURPOSE, IN CONNECTION WITH ACCESSORIES, EQUIPMENT, MATERIALS OR COMPONENTS SOLD BUT NOT MANUFACTURED BY GRACO. These items sold, but not manufactured by Graco (such as electric motors, switches, hose, etc.), are subject to the warranty, if any, of their manufacturer. Graco will provide purchaser with reasonable assistance in making any claim for breach of these warranties.

In no event will Graco be liable for indirect, incidental, special or consequential damages resulting from Graco supplying equipment hereunder, or the furnishing, performance, or use of any products or other goods sold hereto, whether due to a breach of contract, breach of warranty, the negligence of Graco, or otherwise.

FOR GRACO CANADA CUSTOMERS

The Parties acknowledge that they have required that the present document, as well as all documents, notices and legal proceedings entered into, given or instituted pursuant hereto or relating directly or indirectly hereto, be drawn up in English. Les parties reconnaissent avoir convenu que la rédaction du présente document sera en Anglais, ainsi que tous documents, avis et procédures judiciaires exécutés, donnés ou intentés, à la suite de ou en rapport, directement ou indirectement, avec les procédures concernées.

Graco Information

For the latest information about Graco products, visit www.graco.com.

For patent information, see www.graco.com/patents.

TO PLACE AN ORDER, contact your Graco distributor or call 1-800-690-2894 to identify the nearest distributor.



Every Graco purchase comes with A+ Customer Service.

Call: (888) 541-9788 or go to magnum.graco.com for videos and product information.

PROVEN QUALITY. LEADING TECHNOLOGY.

All written and visual data contained in this document reflects the latest product information available at the time of publication.

Graco reserves the right to make changes at any time without notice.

Original instructions. This manual contains English. MM 3A3582

Graco Headquarters: Minneapolis
International Offices: Belgium, China, Japan, Korea

GRACO INC. AND SUBSIDIARIES • P.O. BOX 1441 • MINNEAPOLIS MN 55440-1441 • USA

Copyright 2015, Graco Inc. All Graco manufacturing locations are registered to ISO 9001.

www.graco.com
Revision B, March 2016