

INSTALLATION INSTRUCTIONS FOR 3/4" SINGLE ROD

NOTE: Finial shown is for illustration purpose only. It may not represent the style of finial purchased.

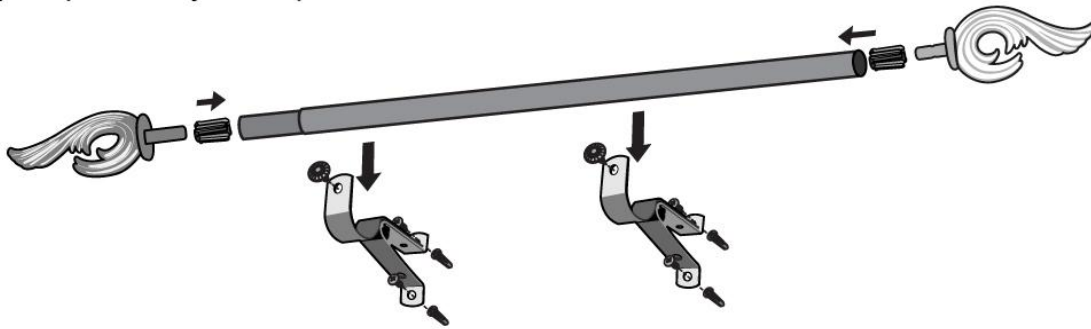

- 1** Place brackets against wall at desired locations. Mark screw holes with pencil. Be sure marks are level across opening.

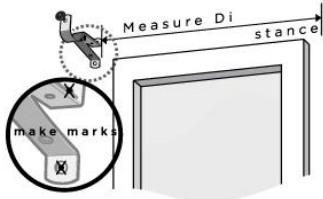

- 2** If screws are going directly into wood trim or wall studs, drill a 1/8" pilot hole at pencil marks. If screwing into drywall, follow drywall anchor instruction in the bottom of the page.

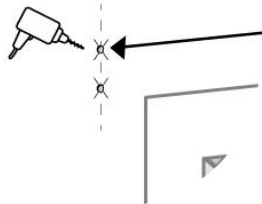

- 3 ASSEMBLE ROD**
Assemble the rod by inserting and sliding the smaller diameter rod into the larger diameter rod. For a three piece rod, place the single rod size in the center position.

- 4 ATTACHING DRAPERY**
Slide the drapery onto the pole.

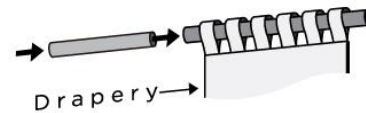

- 5 ATTACHING FINIALS**
There are two diameters of white inserts included. For a three piece rod, there is only one diameter of white insert.

a.
Push corresponding insert into each end of rod with fin side going into the pole and flat end facing out.

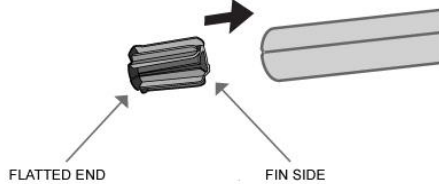

b.
Attach finials by turning the end of the finial screw/bar into the end of the plastic insert until completely snug. Rotate finial on rod for proper alignment if required.

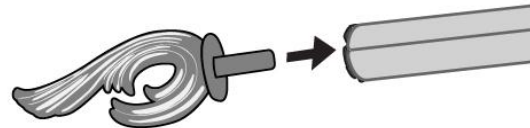

- 6** Extend rod to desired width. Lift rod with drapery and drop into brackets. Adjust draperies to desired position.

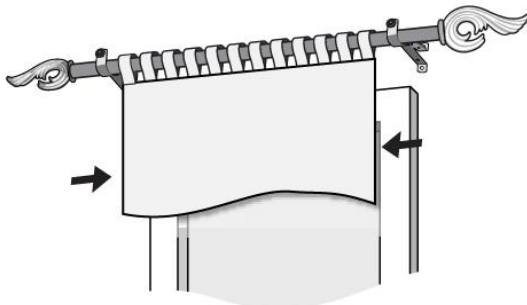

- 7** Lock rods into position by tightening leveling screw by hand until finger tight. This will prevent the rod from moving.

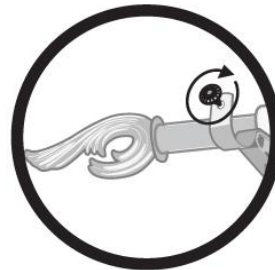

DRYWALL ANCHOR INSTALLATION



If screws are going directly into wood trim or wall studs - drill 1/8" (3mm) holes and install screws through bracket. If screws are going into hollow wall - drill 3/16" (5mm) holes and push or lightly hammer plastic anchors into holes. Then install screws through brackets. Do not tighten screws too much - just snug is best.