

# LFXS30796\*

## QUICK INSTALL & CLEARANCES

For full installation directions/clearances please refer to the corresponding User Manual and Installation Guide.

### DIMENSIONS/CLEARANCES/WEIGHT

A	Depth with Handles	36-1/4"
B	Depth without Handles	33-3/4"
C	Depth without Door	29-1/2"
D	Depth (Total with Door Open)	48-1/8"
E	Height to Top of Case	68-7/8"
F	Height to Top of Door Hinge	70-1/4"
G	Width	35-3/4"
H	Width (Door Open 90° without Handle)	40"
I	Width (Door Open 90° with Handle)	44-1/4"
Installation Clearance		Top 1", Back 2"
Weight (Unit/Carton)		360 lbs / 393 lbs.
Carton Dimensions (WxHxD)		38" x 73" x 39"

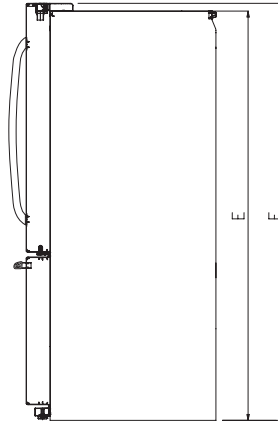
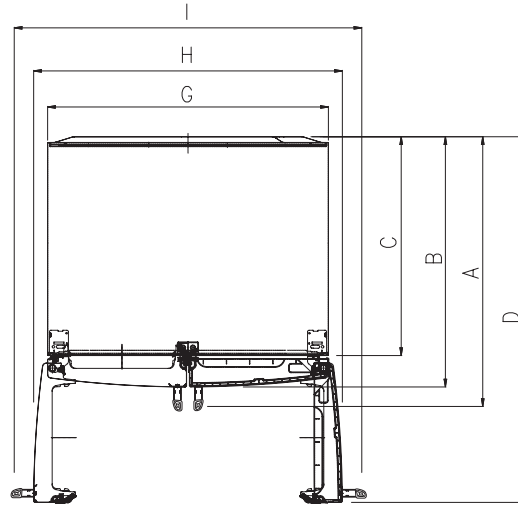

### CLEARANCES

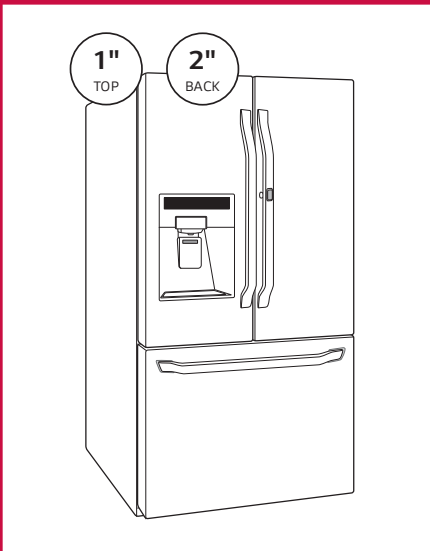

### CONNECTING POWER AND SECURING SPACE FOR WATER SUPPLY PIPE

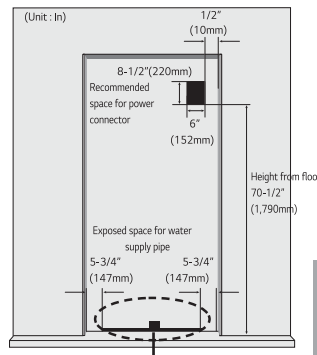

#### Power connection

The location of the 115V 60Hz power connector must be located on the rear side of the product as shown in the picture.

When installing the product, make sure to check whether the cord is hung on the hook on the rear side so that it is not pressed on the refrigerator. Damaged power cord can cause a fire.

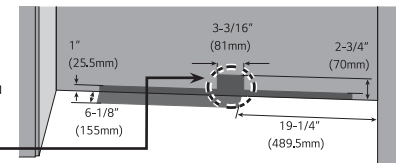

#### Installation space for water supply pipe

Place the water hose for ice maker and water dispenser as shown in the picture, and prepare hose to come up from the floor. (Copper pipe with diameter of 5/16" (8mm) is recommended for the water hose.) If the water pipe and water hose is located far from the product, bury the water hose on the floor and provide appropriate treatment.

- ⚠ Make sure the location of the water supply pipe is within the marked range.
- ⚠ Before connecting the power, always make sure to ground the product. (If the product is not grounded, the user may be able to feel the electricity due to the minute leakage current when touching the refrigerator door handle or side corner even when there is no issue with the product.)
- ⚠ Do not ground the product to gas pipe, plastic water pipe or telephone wire etc. It can cause electric shock and explosion.

