



WOODWORKING & WOOD JOINING TOOLS



WWJ11

Mortise & Tenon Jig

General Tools offers one of the best assortments of wood joining jigs available including our new Mortise and Tenon Jig, The Dovetailer II Jig, and the award-winning EZ Pocket Hole Jig and EZ Jointer Clamp Kits. These heavy-duty

woodworking tools are ideal for furniture building, cabinetry making and other professional carpentry projects. In addition, we offer plenty of wood joining accessories such as screws, plugs and drill bits.

E•Z Pro™



MORTISE & TENON JIG

- Create professional matching Mortise & Tenon Joints Right Out of the Box
- The first of its kind, all-in-one precision machined Mortise & Tenon Jig
- Produce 1/4", 3/8" and 1/2" Mortise and Tenons
- Includes: 1/4" high-speed steel spiral upcut router bit and User's Manual



The Mortise & Tenon joint has been used for thousands of years. Not until now has someone figured out how to provide a fast and straightforward all-in-one solution for cutting both a matching mortise & tenon with a single affordable jig. General's E•Z Pro™ Mortise & Tenon Jig is ready to use right out-of-the-box to produce the widely used 1/4" mortise and tenon joint. Using a plunge router with the jig, woodworkers of all levels can quickly and easily cut both mortises and tenons ranging from 1/4" to 1/2" thick, and from 1" to 3" wide. Without difficulty, this unit can easily handle wood stock ranging from 1/2" to 1-1/2" thick and can cut multiple mortises in a single long piece.

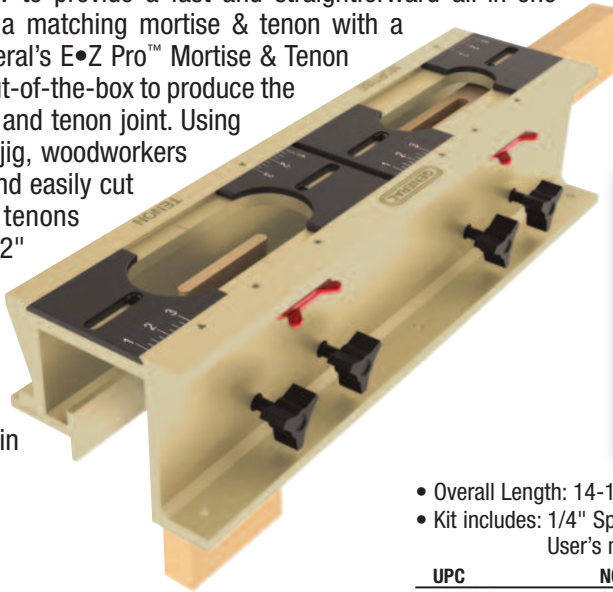

- Overall Length: 14-1/2" Width: 4-1/2" Height: 4" Weight: 2-1/2 lbs
- Kit includes: 1/4" Spiral upcut router bit, Bushing kit, Wrench, User's manual

UPC 26008 3 NO. 870

No. 870
Patent Pending



Woodworking Made Easy!

E•Z Pro

“The Easy Way to Make Professional Furniture Joints”

THE DOVETAILER II

DOVETAIL JIG



With the E•Z Pro™ Dovetailer II and your router, you can cut Professional Dovetail Joints, Simply and Accurately... Right Out Of The Box!

- Self-aligning design ensures that both ends of the dovetail joint match-up evenly every time
- Sturdy machined one piece aluminum construction
- Easily adjusts the dovetail interference to create loose or tight joints
- Portable to your worksite or home workshop
- Use with hand or table router
- New table router control knobs assure safe, comfortable and accurate use
- No need to bolt to the jig onto workbench like many expensive dovetail jigs
- Integrated clamps allow precise clamping of jig to work piece
- Accommodates boards of any widths
- Length: 12"; Width: 3"; Height: 3"; Weight: 2-lbs. 1.1oz.



Cuts Half-Blind Joints



Cuts Through Joints



Includes: 1/2" Dovetail Router bit, User's Manual

UPC	NO.
02124 3	861

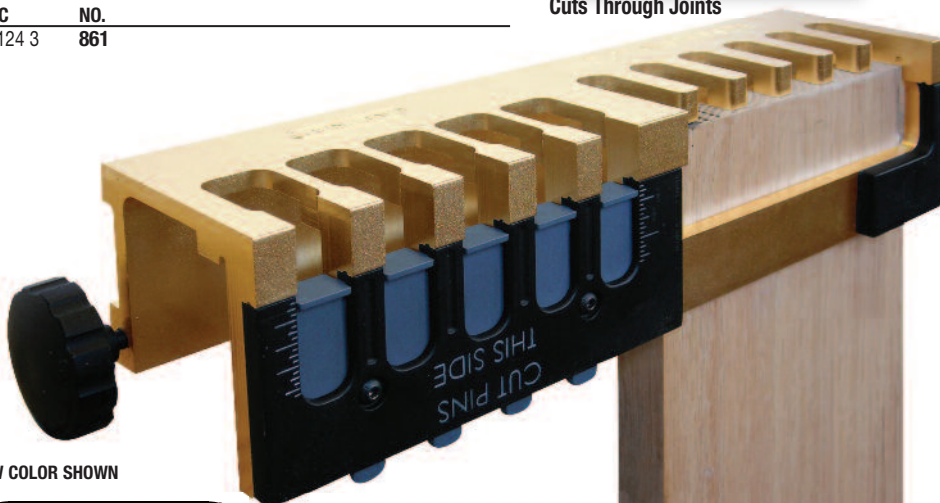

NEW COLOR SHOWN

WOOD JOINING TOOLS

Pocket Hole Jigs



Pocket hole joints are sturdy and simple to make with a drilling jig. By drilling steeply pitched counterbores in one joint member, you can drive self-

tapping screws into the other without pilot holes. Ideal for leg and rail connections and face frame cabinet construction.

E•Z Pro™ POCKET HOLE JIG KITS

- Ideal for leg-and-rail connections, cabinet construction, sneaking screws into tight-squeeze spots or fastening picture frame miters
- Heavy-duty aluminum extrusion and hardened steel bushings
- By drilling steeply pitched counterbores in one joint member, you can drive self-tapping screws into the other joint member without pilot holes
- Built to be portable or bench mounted

- **849 Kit includes:** 1 Pocket Hole Jig with Clamps; 3/8" Step Drill Bit; 1 3/8" Drill Stop and Hex Wrench; 6" Steel Square Drive Bit; Square Drive Screws, Instructions
- **850 Kit includes:** Hard, molded carrying case; All of the above plus . . . 25 Course Square Drive Screws, 25 Fine Square Drive Screws, 25 Wooden Pocket Hole Plugs

UPC	NO.	
708200000515	849	E•Z Pro Pocket Hole Jig Kit
00850 0	850	E•Z Pro Deluxe Pocket Hole Jig Kit



NEW COLOR SHOWN

850



The mark of responsible forestry



849

32 

8492 

8495  50ct.



The mark of responsible forestry



8495 50 COUNT

 100 COUNT



The mark of responsible forestry



No. 8497 shown actual size of 1-1/4" 8497

POCKET HOLE JIG ACCESSORIES

E•Z™ STEP DRILL BIT

UPC	NO.
70820000052 2	32

SQUARE DRIVE BITS

UPC	NO.	DESCRIPTION
02122 9	8492	2-#2 Square Drive Bits 3" and 6" long

POCKET HOLE PLUGS

UPC	NO.	DESCRIPTION	QTY.
02123 6	8495	Pocket Hole Plugs, Hardwood	50

POCKET HOLE SCREWS

UPC	NO.	THREAD	QTY.
08497 2	8497	Coarse	100
08498 9	8498	Fine	100

E•Z Woodworking

For the Professional and the Do-It-Yourselfer



No. 849

SMART DESIGN

- Heavy-duty aluminum extrusion & hardened steel drill bushings
- Built to be portable or bench mounted, and designed with a built-in clamping system

THREE TYPES OF POCKET HOLE JOINTS

- Flush, Corner & Angle

E•Z Pocket Hole Jig Kit

Award Winning Ingenuity!

849 KIT INCLUDES

- 1 Pocket Hole Jig with Clamps; 3/8" Step Drill Bit; 1 3/8" Drill Stop and Hex Wrench; 6" Steel Square Drive Bit; Square Drive Screws, Instructions

850 KIT INCLUDES

- All of the above plus 25 Course Square Drive Screws; 25 Fine Square Drive Screws; 25 Wooden Pocket Hole Plugs and Hard, Molded Carrying Case

AWARD WINNER!



Patent No. 6,254,320

NEW COLOR SHOWN

No. 850



Our E•Z Pro Doweling Kit includes everything you need to make beautiful wood joints like a pro! This heavy-duty aluminum jig simplifies the doweling process, allowing you to create Edge-to-Edge,

Right Angle and Edge-to-Surface joints with little effort. No. 8401 Dowel Accessory Kit can be used with both the No. 840 and No. 841 Doweling Jigs.

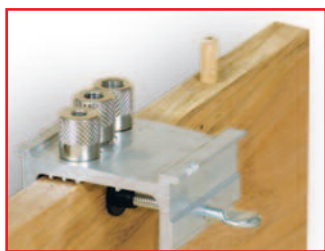

E•Z Pro™ DOWELING JIG KIT

- Dowels add mechanical strength to butt joints and keep miters lined up during clamping
- The pointed notches on the working edges of our jig centers the drill bit automatically for precise registration
- Create 3 types of dowel joints: Edge to edge, right angle, edge to surface, as well as 3 sizes of dowel joints; 1/4", 5/16" and 3/8"

- Ideal for 5/8", 3/4" and 1" thick stock
- **Kit includes:** 1 Dowel Jig; 3 Brad Point Drill Bits; 1/4", 5/16", 3/8"; 3 steel stops 1/4", 5/16" and 3/8" with Hex Wrench, 6 Dowel Center Points; 2 each of 1/4", 5/16" 3/8", supply of wood dowels, Instructions

UPC	NO.
70820000317	841 E•Z Pro Dowling Jig Kit

NEW COLOR SHOWN



841



The mark of responsible forestry



Patent No. 7,001,118



Photos property of Woodworker's Journal



The mark of responsible forestry



841516



8401

DOWEL ACCESSORY KITS

- **8401** Kit includes: 3 Drill Bits - 1/4", 5/16", 3/8"; 3 Drill Stop Collars, 6 Dowel Centers, 10 ea. Fluted Dowel Pins 1/4", 5/16", 3/8"
- Replacement bit for General's E•Z Pocket Hole Jig Kit (No. 849)
- Accessories Kit for General's Pro Doweling Kit (No. 840) and E•Z Dowel Kit (No. 841)
- **841014** Kit includes: 12-1/4" Dowel Pins, 1-1/4" Brad Point Drill Bit, 1-1/4" Drill Stop Collar, 2-1/4" Dowel Centers, 1 Hex Key
- **841516** Kit includes: 12-5/16" Dowel Pins, 1-5/16" Brad Point Drill Bit, 1-5/16" Drill Stop Collar, 2- 5/16" Dowel Centers, 1 Hex Key
- **841038** Kit includes: 10-3/8" dowel Pins, 1-3/8" Brad Point Drill Bit, 1-3/8" Drill Stop Collar, 2-3/8" Dowel Centers, 1 Hex Key

UPC	NO.	
08401 9	8401	Dowel Accessory Kit
02119 6	841014	1/4" Dowel Accessory Kit
02120 2	841516	5/16" Dowel Accessory Kit
02121 9	841038	3/8" Dowel Accessory Kit



WOOD JOINING TOOLS

Wood Joinery



General's E•Z Pro™ Jointer Clamp Kit is the alternative to expensive jointers. Now, you can straight-line rip crooked boards using your table saw! Just attach your crooked board to a piece of straight stock using the Jointer Clamps

and run the stock along the rip fence to rip the crooked board. Works in two easy passes. Great for use with long stock. Patented swing arm design allows you to accurately rip wide boards with ease.

DOWEL CENTERS

- General's dowel centers are the quickest and most accurate method to locate, transfer and match dowel holes
- Made of nickel plated steel

- **Set includes:** 8 pcs., two of each size: 1/4", 5/16", 3/8", 1/2" diameter

UPC	NO.	
25099 5	888	Dowel centers



888

DRILL STOP SET

- For use on twist or brad point drills to prevent excessive drill penetration
- Positive depth control assures exact hole depths for multiple drilling jobs
- Black oxide finish on cold rolled steel

- Includes hex wrench

UPC	NO.	SIZES INCLUDED
23096 6	S838	3/16" dia., 1/4" dia., 5/16" dia., 3/8" dia., 7/16" dia., 1/2" dia.



S838

E•Z Pro™ TRU-EDGER JOINTER CLAMP

- The long awaited alternative to expensive jointers!
- Straight line rip crooked boards on your table saw
- Just mount the clamps to a guide board to create a flat reference edge
- The guide board can be made from any straight edged scrap
- Clamp the stock to the guide board and make your rip cut
- Get a dead-flat edge every time, with no extra waste
- The jointer clamps work on any length stock up to 2" thick
- Instructions included

UPC	NO.	CAPACITY
70820000010	846	2" stock



NEW COLOR SHOWN

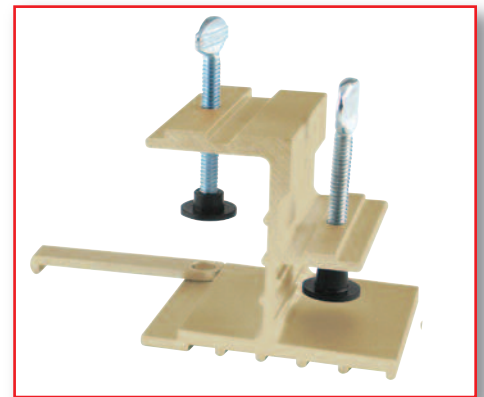

NEW COLOR SHOWN

846

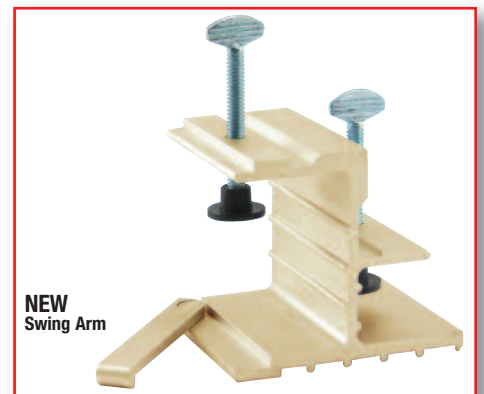
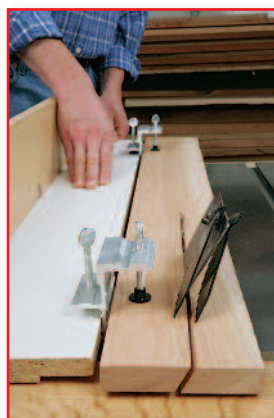

NEW COLOR SHOWN

NEW
Swing Arm

Photos property of Woodworker's Journal

Patent No. 7,000,519



General's Pro Doweling Jig is a precision jig that assures the accurate line-up of dowel holes in furniture and carpentry. Simply clamp the jig onto

your workpiece to quickly and accurately drill holes for dowel pins requiring exact alignment in the edge, end or surface of your work.

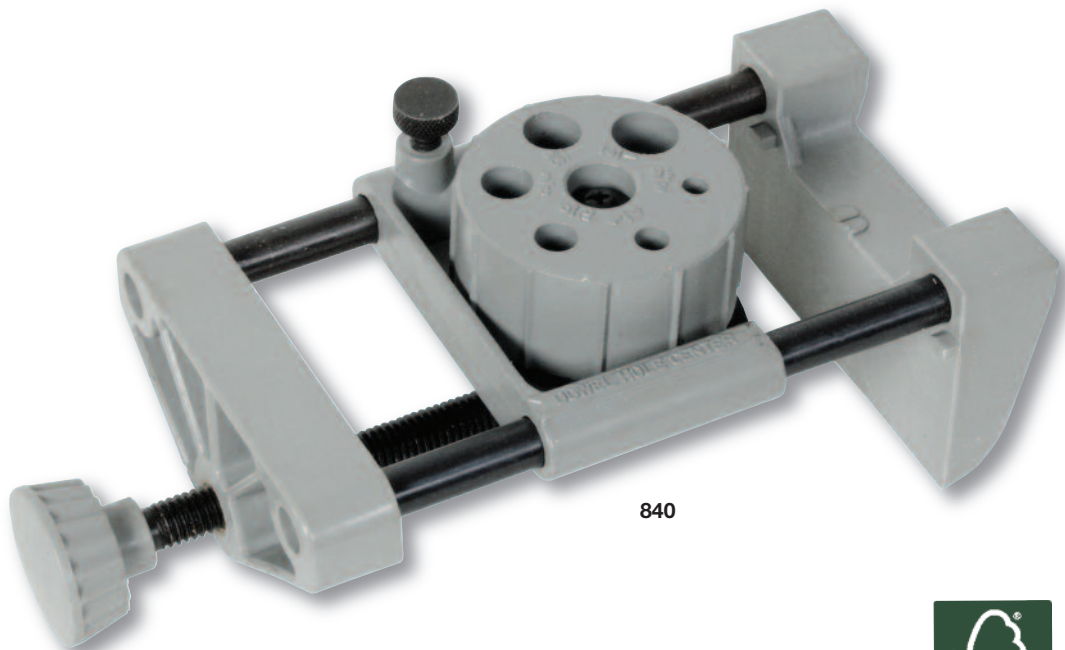

840

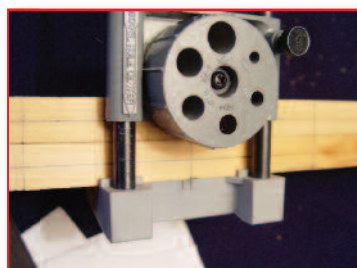
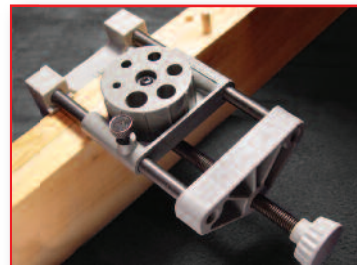

The mark of responsible forestry

For clean joints that need to be strong and fastener-free, there's almost no substitute for the dowel joint. However, if dowel holes are even slightly askew, the dowels won't mesh rendering the joint unusable. General's E•Z Pro Doweling Jig offers a simple, versatile way to produce precision edge-to-edge, right angle, or edge-to-surface joints. The Kit features three size dowels (1/4", 5/16" and 3/8"), and the jig has three different drilling positions designed for stock of 5/8", 3/4" and 1" thick. Steel stops allow you to vary the depth of the cut. Perfect for joints that will be press fit or glued.



PRO-DOWELING KIT

- A precision jig that assures accurate line up of dowel holes in furniture and carpentry
- Revolving hardened sintered turret has six twist drill sizes
- Instructions included
- Drill sizes: 3/16", 1/4", 5/16", 3/8", 7/16", 1/2"
- **Package Contents:**
 - 1 Doweling Jig;
 - 3 Brad Point Drill Bits, 1/4", 5/16", 3/8";
 - Dowel and Tenon Centers Set from 3/16" ID to 1/2" OD;
 - 3 Drill Stops, 1/4", 5/16", 3/8";
 - 30 Dowel Pins, 10 each 1/4", 5/16", 3/8";
 - Wood Glue

UPC	NO.
24120 7	840



The AccuDrill Precision Drill Guide adds a whole new level of accuracy to your standard power drill. The AccuDrill is great for angle drilling, doweling, plug cutting and even edge sanding. With the easy-to-use protractor scale, you can

adjust the Drill Guide in five degree increments from 0-45°, left and right. In addition, V-Guides on the base permit drilling through dowel or other rounded stock. Attaches to all 3/8" and 1/2" power drills. Folds for tool-box storage.

PRECISION DRILL GUIDE

- Attaches to all 3/8" and 1/2" power drills
- Cross slide lock for accurate shaping and carving
- 3/8" capacity drill chuck with key
- Positive stop for accurate drill depth control
- Dual locking knob and handle holds precise angle setting
- Folds flat for tool box storage
- Easy-to-read protractor scale has 5° graduations (0° - 45° left or right)
- V-guides automatically center round stock for drilling
- Self centering channel for edge drilling

UPC NO.
23059 1 36/37 AccuDrill Precision Drill Guide

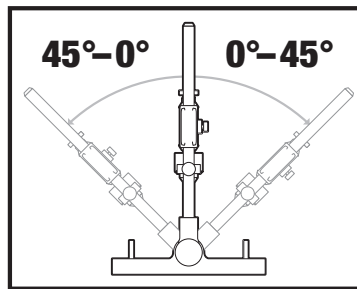
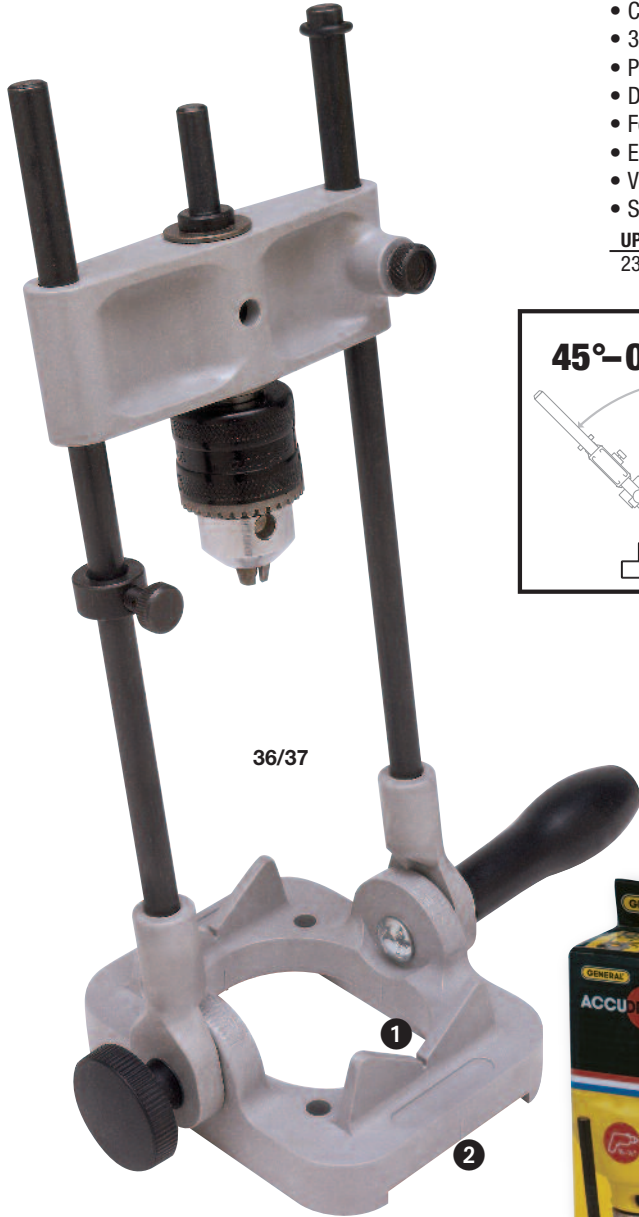

- 1 For round Bar Center Drilling
- 2 Straight Edge Center Drilling



As an FSC (Forest Stewardship Council), certified company, General's Wood Joining Program includes wood based products that are manufactured in accordance with FSC standards. The FSC is an independent, non-

governmental, not-for-profit organization established to promote the responsible management of the world's forests and is nationally represented in more than 50 countries around the world.



840014
840516
840038
840012

840014 shown

FLUTED DOWEL PINS

A fluted dowel pin has a series of parallel grooves cut along its length providing channels through which excess glue—that is used to secure the dowel pin in its hole—can escape as the dowel is inserted. This relieves the hydraulic pressure that might otherwise split the timber when the mating pieces are clamped together. General's fluted dowels are ideal for creating strong and secure joints in furniture, cabinets, trim and special woodworking projects.

- Made of straight-grained solid hardwood
- Expands when used with water-based glue for extra tight joint
- Fluted for easy insertion

UPC	NO.	DESCRIPTION	QTY.
02101 4	840014	1/4" Fluted Dowel Pins	72
02102 1	840516	5/16" Fluted Dowel Pins	50
02103 8	840038	3/8" Fluted Dowel Pins	35
02104 5	840012	1/2" Fluted Dowel Pins	20



313038
313012
315516
315038
315012

313038 shown

FLAT HEAD PLUGS

- Premium Flat Head Screw hole Plugs have a tapered tenon to insure a tight fit
- Designed to form a flush finish in furniture and other woodworking applications
- Paint or stain for a perfect wood-color match or for accentuated contrast

UPC	NO.	DESCRIPTION	QTY.
02109 0	313038	3/8" Flat Head Plugs, Oak	50
02110 6	313012	1/2" Flat Head Plugs, Oak	50
02113 7	315516	5/16" Flat Head Plugs, Hardwood	50
02114 4	315038	3/8" Flat Head Plugs, Hardwood	50
02115 1	315012	1/2" Flat Head Plugs, Hardwood	40



311038
311012
312038
312012

311038 shown

BUTTON HEAD PLUGS

Button Head plugs are ideal for filling in those unsightly screw holes and can be installed easily with wood glue. Button head plugs can be used for a variety of craft, wood working and furniture projects.

- When fully-seated, the domed, button head protrudes above the wood surface and over the screw hole edge adding a more decorative look
- Slightly tapered plug body to ensure a tight secure fit

- Wood grain runs in the direction of the plug width for best match
- Paint or stain for a perfect wood-color match or for accentuated contrast

UPC	NO.	DESCRIPTION	QTY.
02105 2	311038	3/8" Button Plugs, Oak	50
02106 9	311012	1/2" Button Plugs, Oak	50
02107 6	312038	3/8" Button Plugs, Hardwood	50
02108 3	312012	1/2" Button Plugs, Hardwood	50





The important characteristics of wood joints are strength, flexibility, toughness and appearance. Both exterior and interior temperature changes can cause major shifts in the moisture content of wood and can

compromise the strength and longevity of a joint. General's wood based joining products have been developed to provide strong joints that adjust to every day environmental changes.

ROUND HEAD PLUGS

- Premium Round Head Screw hole Plugs with tapered tenon to insure tight fit
- Designed to form a slightly raised round finish in woodworking applications
- Paint or stain for a perfect wood-color match or for accentuated contrast

UPC	NO.	DESCRIPTION	QTY.
02112 0	314038	3/8" Round Head Plugs, Oak	50
02116 8	316038	3/8" Round Head Plugs, Hardwood	50
02117 5	316012	1/2" Round Head Plugs, Hardwood	40



314038
316038
316012

314038 shown



SHAKER PEGS

Made from solid hardwood, General's Classic Shaker pegs can be useful throughout the entire house. Install them in the foyer or mud-room, kitchen, bathroom, child's room etc. Hang your favorite coffee mugs, towels, hats, neck ties, toys and even herbs!

- Create customized pegboards to better organize your work and living spaces
- Use General's Shaker pegs to replace damaged pegs in your pegboards
- Paint or stain for a perfect wood-color match or for accentuated contrast

UPC	NO.	DESCRIPTION	QTY.
02118 2	317000	Shaker Pegs	2

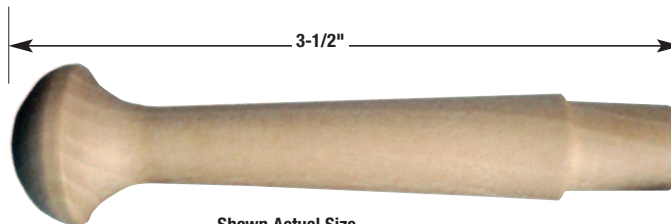

317000



BISCUITS

Wood Biscuits, sometimes referred to as Wood Plates or Wafers, are used for edge or corner-jointing. When General's biscuits come into contact with water based glue they swell, thus creating a 'locked' joint for a strong secure fit.

- Used for Wood Joinery with Biscuit Joiners
- Great for furniture, cabinets and trim
- Biscuits soak up water-based glue for a tighter wood joint

UPC	NO.	DESCRIPTION	QTY.
02134 2	318000	Size #0	50
02135 9	318010	Size #10	50
02136 6	318020	Size #20	50
02133 5	318050	Size FF	50



318000



Pocket Hole Accessories

Pocket-hole joinery or pocket-screw joinery is one of the best methods for joining two pieces of wood to ever come down the pike. Fixing a squeaky chair, or a wiggly table, is as easy as adding a few pocket

holes and screws to pull the separating pieces together. General's Pocket Hole Screws No. 8497 and 8498 are used specifically for this purpose and are offered in both fine and coarse thread.

8497
8498



No. 8497 shown
actual size of 1-1/4"

POCKET HOLE SCREWS

- Self-tapping
- Use a coarse thread screw in soft material (8497)
- Use a fine thread screw in hardwoods (8498)
- Nickel-plated
- Pan Head
- Size: 1-1/4"

UPC	NO.	DESCRIPTION	QTY.
08497 2	8497	Coarse Screws	100
08498 9	8498	Fine Screws	100

8497 shown

8495



POCKET HOLE PLUGS

Pocket Holes are often hidden from sight on the back surface of a face frame, under a table top, or on the back of picture frame. What do you do about unattractive pocket holes that will be visible on a finished product the answer? Pocket hole plugs! These wood plugs, made from 100% hardwood, can make the pocket holes beautifully disappear.

UPC	NO.	DESCRIPTION	QTY.
02123 6	8495	Pocket Hole Plugs, Hardwood	50



The mark of responsible forestry

32



E•Z™ PRO STEP DRILL BIT

The E-Z Step Drill Bit is great for creating pocket hole joints or counter boring. The 3/8" bit is made of high speed steel and includes a drill stop and hex wrench for accurate setting of drill depth. This item can also be used as a replacement bit for General's Pocket Hole Jig Kit (#849).and Deluxe Pocket Hole Jig Kit (#850).

- Replacement bit for General's E•Z Pocket Hole Jig Kit (No. 849)

- 3/8" x 6" (9.5 x 152mm) step drill bit
- High speed steel
- Ideal for creating pocket hole joints and counter-boring
- Includes 3/8" (9.5mm) steel drill stop with hex wrench

UPC	NO.
70820000052 2	32



General's Drill Accessories are engineered to do precision work in the many specialized drilling and cutting operations required for fine carpentry and metal working.

They expand the capabilities of portable electric drills, drill presses, drill stands, bit braces and hand drills. Our Drill Accessories are built for precision and durability.

SQUARE DRIVE BITS

For use with General's Pocket Hole Screws. These drive bits are essential for building decks, benches, tables and other woodworking projects. General's Square Drive Bits have a hardened steel tip that assures perfect fit and lasts longer.

- #2 Square drive bits
- 3" (76mm) length
- 6" (152mm) length
- Use with deck screws

UPC	NO.	DESCRIPTION
02122 9	8492	2-#2 Square Drive Bits 3" and 6" long

8492



PLUG CUTTERS

Whether you're building cabinets, toys, decks, furniture or railings, wooden plugs are a neat way to cover up the screw heads. Made from hardened alloy steel, General's Plug Cutters will cut a 3/8-inch plug from any wood stock and eject it, whether it's chucked in a press or hand-held drill. This is a great economical bit, perfect for homeowners.

- General's Plug Cutters produce accurate plugs for covering screw holes in decking, flooring and other woodworking projects
- Permits choice of matching or contrasting plugs for decorative effect
- Engineered to start cutting plugs easily with hand-held drills or drill press

- Cutter will produce and eject straight plugs from stock up to 3/4" thickness
- Made of hardened alloy steel

- Individual sizes:

UPC	NO.	SHANK	DIA.
23024 9	31A	3/8"	3/8" dia.
23030 0	31B	3/8"	1/2" dia.
23033 1	31C	3/8"	5/8" dia.

- Set of 3 Diameters - 1/4", 3/8", 1/2":

UPC	NO.	SHANK
23036 2	S31	3/8"



31A

31B

31C

ADJUSTABLE PILOT BITS

Drill, countersink and counter-bore precision screw holes in a single operation with General's Adjustable Pilot Bit Set. Featuring four high-speed bits with adjustable lengths, this set can be a great time saver for fine carpentry and woodworking. The 1/4" hex shank allows the set to be used in both electric drills and power screwdrivers.

- Drill, countersink and counterbore precision screw holes in a single operation when doing fine carpentry and woodworking

- Hardened high-speed pilot bits give long life
- Black oxide finish deters rust
- 1/4" hex shanks prevents slippage in electric drills and can be used in power screwdrivers
- Adjustable drill and high performance angle on countersink

UPC	NO.	SCREW SIZES
23041 6	34ST	Set of 4 Pilot Bits (Sizes 5 - 14)

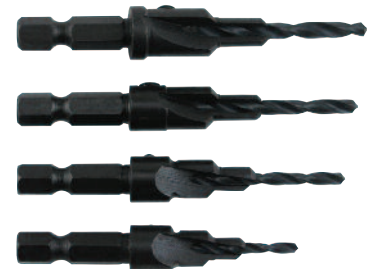

34ST

Circle Cutters



General's Circle Cutters produce precision circles in sheet metal, brass, copper, soft steel, aluminum, plastic, wood and composition materials. Bodies are constructed of heat treated tool steel for durability.

The replaceable cutter blades are made of high-speed steel for precise and clean cuts. Circle Cutters are adjustable for cutting various diameter holes. A hex wrench is included for adjustments.

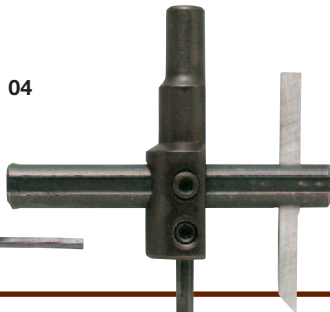

4" MAX CIRCLE CUTTER

- Round shank circle cutter
- Replaceable high-speed steel cutting blade and replaceable 1/4" pilot drill
- All adjustments are made with a hex wrench which is included
- **Maximum safe speed is 500 RPM**
- **For use with drill press only**

UPC	NO.	DESCRIPTION
21003 6	04	4" Circle Cutter
27006 1	4	Replacement Drill
27003 0	4/5	Replacement Blade

- Capacity: 7/8" to 4"
- Shank: 3/8" Round

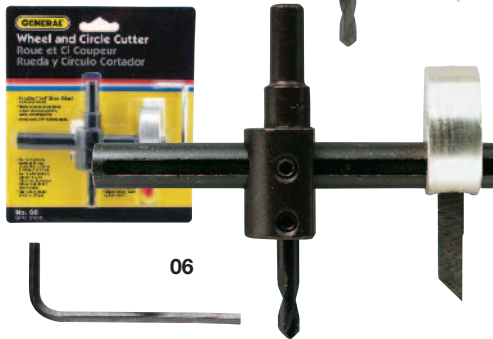

WHEEL AND CIRCLE CUTTER

- General's Wheel and Circle Cutter is the only one that cuts the exact diameter you need anywhere from 1" to 6" (26 to 152mm)
- Ideal for woodworkers, model builders, clockmakers, and hobbyists
- Produces precision circles and holes in sheet metal, brass, copper, aluminum, plastic, wood, and composition materials
- Change from circle to wheel cutting by simply reversing the double ended blade
- Sturdy round shank for use in any drill press or drill stand with 3/8" chuck

- Replaceable double ended 9/32" cutter blade is made of high-speed steel for precise clean cuts
- All adjustments are made with a hex wrench which is included
- **Maximum safe speed is 500 RPM**
- **For use with drill press only**

UPC	NO.	DESCRIPTION
21010 4	06	Circle Cutter
21014 2	5/6/55	Replacement Drill
21013 5	6	Replacement Wheel

- Capacity: 1" to 6"
- Shank: 3/8" Round

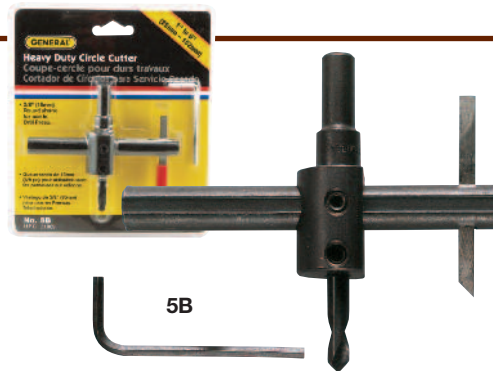

6" MAX CIRCLE CUTTER

- Has been a General Tools customer favorite for more than 30 years
- Adjusts from 1" to 6" (26 to 152mm) diameter circles
- Replaceable high-speed steel blade and replaceable 1/4" pilot drill
- All adjustments are made with a hex wrench which is included
- **Maximum safe speed is 500 RPM**
- **For use with drill press only**

UPC	NO.	DESCRIPTION
21009 8	5B	Circle Cutter
21014 2	5/6/55	Replacement Drill
27003 0	4/5	Replacement Blade

- Capacity: 1" to 6"
- Shank: 3/8" Round

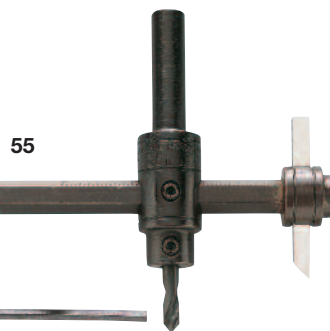

HEAVY-DUTY CIRCLE CUTTER

- General's industrial quality cutter is most preferred by professionals
- 1/2" round shank for drill press use
- Replaceable high-speed tool steel blade and replaceable 1/4" pilot drill
- Markings on beam for easy measurement

- All adjustments are made with a hex wrench which is included
- **Maximum safe speed is 500 RPM**
- **For use with drill press only**

UPC	NO.	DESCRIPTION
21012 8	55	Circle Cutter
21014 2	5/6/55	Replacement Drill
27015 3	55	Replacement Blade

- Capacity: 1-3/4" to 7-7/8"
- Shank: 1/2" Round



WASHER AND GASKET CUTTER

- This tool cuts washers and gaskets in leather, rubber, cork, graphite, fiber, copper and other soft materials
- Combination round and square shank permits use with bit brace or hand drill
- Made of steel with graduated beam to adjust to diameters from 5/8" to 6-1/2" (16 to 165mm)
- Replaceable tool steel Cutter Blades No. 11B

- Two independently adjustable cutter blades cut inside and outside diameters simultaneously
- **Maximum safe speed is 100 RPM**
- **For hand held variable speed drills only**

UPC	NO.	DESCRIPTION
21024 1	11	
27024 5	11B	Replacement blades (Pair)

- Capacity: 5/8" to 6-1/2" (16 to 165mm)

Countersinks, Drill Bits, Gages



Pilot Bits, countersink and counterbore precision screw holes in a single operation. Self-Centering Hinge Bits drill highly accurate pilot holes in cabinet and door hinges.

Stair gages assure fast and uniform layout in repetitive work including angle cuts on rafters and stair stringers.

- The rose pattern cutting flutes assure chatter free countersinking on steel, brass, aluminum, plastic, wood & other materials
- Made of high-speed steel with five flutes
- 82° point angle
- Stepped shank for use with 1/4" and 3/8" chucks

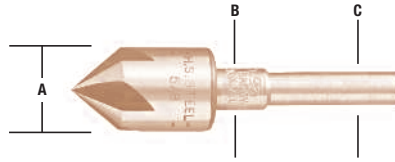

NO.	A	B	C
195-1/2	1/2"	3/8"	1/4"
195-5/8	5/8"	3/8"	1/4"
195-3/4	3/4"	3/8"	1/4"

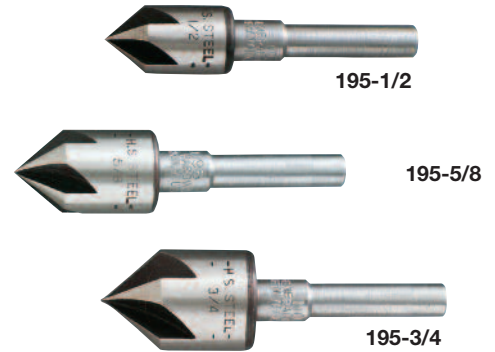

UPC	NO.
23047 8	195-1/2
23053 9	195-5/8
23050 8	195-3/4 "

SELF-CENTERING HINGE BITS

- Highly accurate bits are used for drilling pilot holes in cabinet and door hinges, door butts and all large and small hardware
- Spring loaded outer guide keeps the high speed drill centered for perfect pilot holes
- Adjustable drill depth

UPC	NO.	DRILL SIZE	DRILL DEPTH	SCREW SIZE
22154 4	291	5/64"	1/8"	3 & 4 screw size
22149 0	292	7/64"	7/32"	5 & 6 screw size
22150 6	293	9/64"	5/16"	8 & 10 screw size

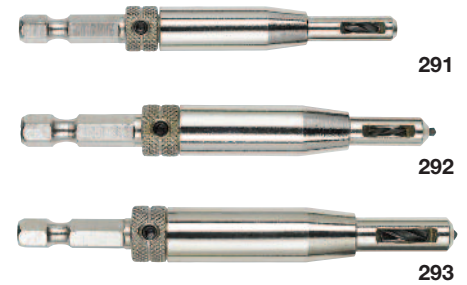

JIFFY CENTERING PUNCH

- For quickly starting screw holes when attaching countersunk hardware such as hinges, hasps, hangers and drawer pulls
- Countersunk end ensures starting hole is centered in hardware screw hole
- Hardened steel pin
- Length: 2-1/2" (68mm)
- Body diameter: 3/8" (10mm)

UPC	NO.
24018 7	806



STAIR GAGE SET

- Brass plated steel stair gage assures fast and uniform layout in repetitive work including angle cuts on rafters and stair stringers
- Attaches easily to all metal rafter squares
- Set of 2 pieces

UPC	NO.
24009 5	803

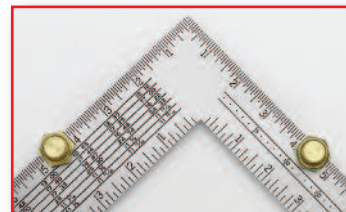

803

WOOD WORKING TOOLS

Digital Layout Tools



General has a full range of specialized digital tools designed for measurement operations necessary in construction jobs, cabinet making and fine

carpentry. Woodworkers trust the quality, accuracy and value that General Tools gives them. It's your job . . . General Tools make it easier.



**THE 1st
OF ITS KIND!**

DIGITAL SLIDING T-BEVEL

- 2 Tools in 1 - Digital Sliding T-Bevel and Protractor
- Large digital angle readout
- Holds measurement for transfers
- Reverse Display button, Flip Display button, Locking Knob for manual measurement transfer
- 4 function control buttons
- Auto Shut off feature
- 8" Stainless Steel blade
- Impact resistant ABS handle
- Full LCD Display
- Measures and transfers angles

- Range: 0-360°
- Resolution: .05°
- Accuracy: 0.3°
- Voltage: DC 2.5V-3.2V
- Power Source: 1 "CR2032" 3V Lithium battery (included)

UPC	NO.
08280 7	828



828
Patent Pending



DIGITAL PRECISION PROTRACTOR

The Digital Protractor displays absolute and relative angle measurements in a large, easy-to-read LCD window

- Installing crown molding, cabinetry, counters, staircases, roofs, windows or flooring
- Takes the guesswork out of measuring, marking, reading and transferring angles
- 6" (150mm) stainless steel protractor arm with knurled locking nut
- Large, easy-to-read display
- Absolute and relative measurements
- Accuracy: 0.1°
- Resolution: 0.05°
- Range: 0 to 180°
- Display can be inverted for easy reading
- Measurement hold function
- Power Source: 1 "CR2023" (3.0V) battery (included)

UPC	NO.
26008 6	1702



1702
Patent Pending

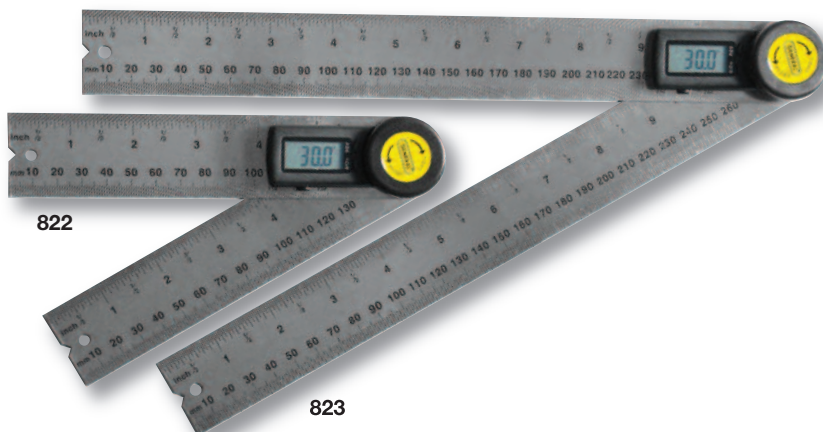
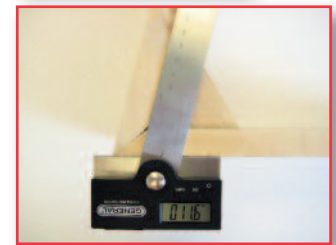

5" AND 10" DIGITAL ANGLE FINDER RULES

- Digital stainless steel angle rules make precise measurements for easy woodworking
- Calculates interior (inside) and exterior (outside) angles easily and accurately in seconds
- Lock and reverse angle features for all types of work
- Large easy to read LCD display
- Hinge mechanism allows a full 360 degrees to measure inside/outside and reverse angles
- Can be zeroed at any point in the swing
- Overall Length for 822: 7" Width: 1-3/8" Depth: 6/8"
- Overall Length for 823: 10-7/8" Width 1-3/8" Depth: 6/8"

UPC	No.	
00822 7	822	5" Digital Angle Finder
00823 4	823	10" Digital Angle Finder



General's newest "Fraction +" Caliper has a three mode digital display. Measuring in inches, metric and fractions it offers everything for the hobbyist to the professional.

The Combination Squares are specifically designed for carpenters, the woodworking trade, the do-it-yourselfer and home mechanics. A necessary tool for every carpenter and home workshop.

FRACTION+

DIGITAL FRACTIONAL CALIPERS

- No. 147, No. 1478, No. 14712 are heavy-duty stainless steel construction
- No. 146, No. 1433 are constructed of non-marring carbon fiber
- Convenient auto-off feature
- Three mode digital display: Decimal Inches, Fractional and Metric
- Inside, outside, depth & step measurements
- Accuracy: +/- 0.001" +/- 0.02mm
- Resolution: 0.0005", 0.01mm, 1/64"
- Power Source: 1 "SR44" battery (included)

UPC	NO.	RANGE
01433 7	1433	0 - 3" (0 - 76mm)
01460 3	146	0 - 6" (0 - 153mm)
01470 2	147	0 - 6" (0 - 153mm)
01478 3	1478	0 - 8" (0 - 203mm)
14712 7	14712	0 - 12" (0 - 305mm)



No. 146 Digital Display

No. 147 Fractional Display

SINGLE BAR MARKING GAGE

- 6" (153mm) adjustable bar is nickel plated steel graduated in 16ths
- Die-cast head
- Fine needle point for precision marking

UPC	NO.
24050 7	820

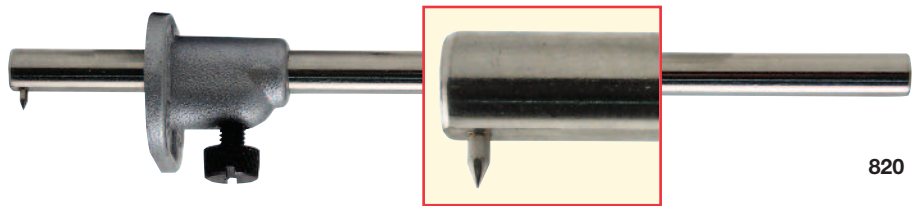

820

PROFESSIONAL CARPENTER'S COMBINATION SQUARE

- Specially designed for carpenters and the woodworking trades
- Machined and enameled cast iron head has precision level and scriber for producing right and 45° angles
- 12" x 1" (305 x 26mm) steel blade is graduated in 8ths, 16ths, and 32nds
- Conforms to government specifications GGG-S-656C

UPC	NO.	FRONT GRADS	BACK
24036 1	812	8ths, 16ths	16ths, 32nds
22193 3	812-CA	Clamp Assembly	

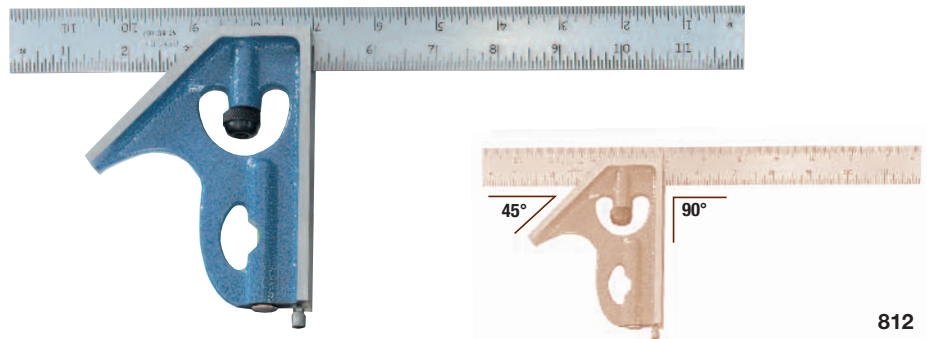

812

UTILITY COMBINATION SQUARE

- Economy version of the carpenter's combination square is perfect for the do-it-yourselfer and home mechanic
- 12" x 1" (305 x 26mm) steel blade is graduated in 8ths, 16ths, and 32nds
- Heavy zinc cast head with level and scriber

UPC	NO.	FRONT GRADS	BACK
24030 9	811	8ths, 16ths	16ths, 32nds

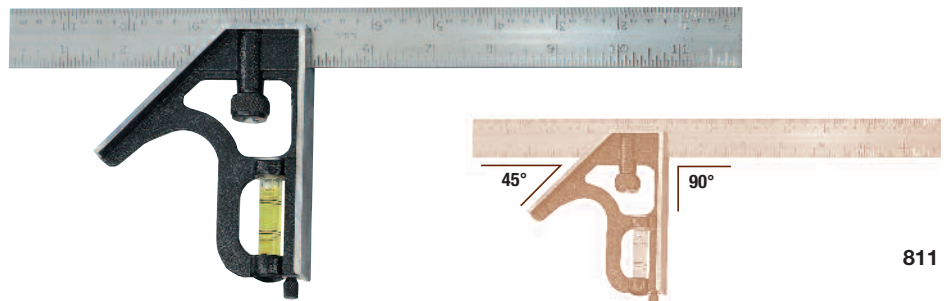

811



General's Contour Gages can duplicate any shape. The pins on our gage slide to conform to irregular surfaces. This tool can be used for pattern and mold making, duplicating parts and contours.

Great for fitting carpet, floor tiles and linoleum against door casings and pipes. The **ANGLE-IZER™** can replace the need for making templates and can be used again and again. The **Ultimate Template Tool**.



833



10" CONTOUR GAGE

- Extra length is ideal for woodworking, linoleum installation, ceramic tile installation or any job where contour duplication is essential
- Gage will fit profiles up to 10" long
- Inch/mm graduations on body
- 3" (76mm) deep fingers will measure profiles up to 1-1/4" (32mm)
- Made from tough, durable plastic

UPC	NO.
08330 2	833



837



6" CONTOUR GAGE

- Ideal for woodworking, linoleum installation, or any job or hobby where contour duplication is essential
- Inch graduation on body
- Stainless steel pins
- Component parts are enamel painted and brass plated
- Size is 6" x 3-1/2" (152 x 89mm) with an overall travel of 5-1/4" (133mm)

UPC	NO.
24116 0	837



836

THE ANGLE-IZER™

- The unique and versatile **ANGLE-IZER™** The Ultimate Template Tool eliminates the need for making templates and can be used again and again
- The **ANGLE-IZER™** can be set-up in seconds not only improving quality but saving time
- Just form the tool into the shape of your work area, then use it to mark your work-piece to be cut
- Repeat accurate marking for creating bulls eyes, arches, repetitive angles or shapes

- Tool can be set to mark bricks, tiles, lumber and laminates
- All the arms are dual-calibrated in inches and metric measures
- Unique tightening mechanism for one-handed operations
- Fiberglass filled nylon for added strength and flexibility
- Includes FREE instructional **ANGLE-IZER™** CD program

UPC	NO.
08360 9	836



REPETITIVE MARKING



MARKING LUMBER



ANGLES FOR PAVER BRICKS

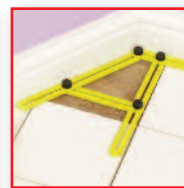

TILING

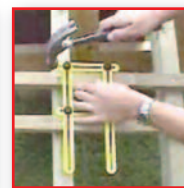

SPACING AND GAUGING

Patent No. Des. 402,217



General's Compasses and Layout Tools are designed for the specialized operations of measuring and layout necessary in construction

jobs, cabinet-making and fine carpentry. Woodworkers trust the quality and the value that General Tools provides.

HOBBY DRILL GAGE

- Heavy gage stainless steel gage conveniently identifies drill bit sizes
- Etched graduations are filled in black to give high contrast and will not wear off
- Gage measures 2-3/8" x 6-3/4" (60 x 172mm) overall
- Stainless steel will not rust

UPC	No.	SPECIFICATIONS
22011 0	24	Fractional size drills 1/16" to 1/2" x 64ths

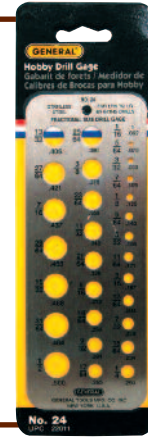

24

OUTSIDE, INSIDE & SLOPED ANGLE PROTRACTOR

- Use this protractor/angle finder to measure and mark the degrees of an angle on outside, inside and sloped angles
- Fine black graduations from 0° to 165° in opposite directions
- Brass lock nut

UPC	NO.
22148 3	29

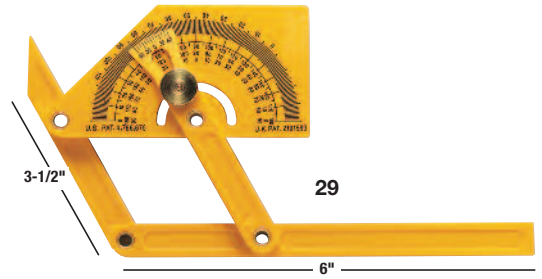

29

PROFESSIONAL QUALITY T-BEVEL

- Our T-bevel is the tool preferred by the craftsperson who wants the finest quality tools
- Solid mahogany 5-1/2" (140mm) handle with brass trim and locking wing nut
- 10" (254mm) blade
- Conforms to government specifications GGG-B-211b

UPC	NO.
24100 9	829



829

PENCIL COMPASS AND SCRIBER

- Designed for marking contours and circles
- Positive wing nut adjustment
- Full-length hardened steel pin in metal frame for greater rigidity
- Constructed of brass plated steel

UPC	NO.	CAPACITY
24132 0	843/1	8" (203mm)



843/1

PRECISION PENCIL COMPASS

- Carpenter quality compass is made of long lasting die-cast rust proof metal
- Spring tension adjustment for marking up to 9" (229mm) diameters
- Scribe guide for edge marking
- For use with pencil (included) or slim ballpoint pen

UPC	NO.	CAPACITY
24126 9	842	9" (229mm)

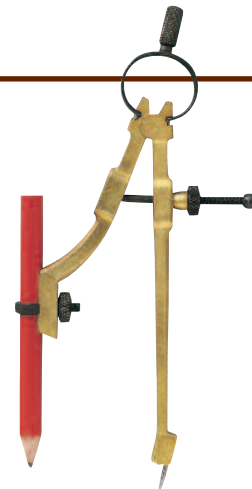

Trammels



General's Adjustable Trammels accurately measure and mark distances that are too great for conventional compasses and dividers. Trammels will accurately transfer measurements, scribe arcs

and lay out circles. Points can be replaced with pencils, ballpoint pens, crayons or soap-stone sticks for marking various materials.

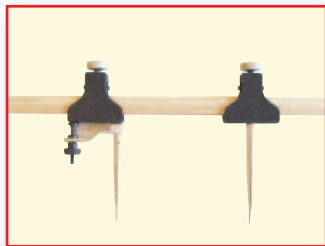

520

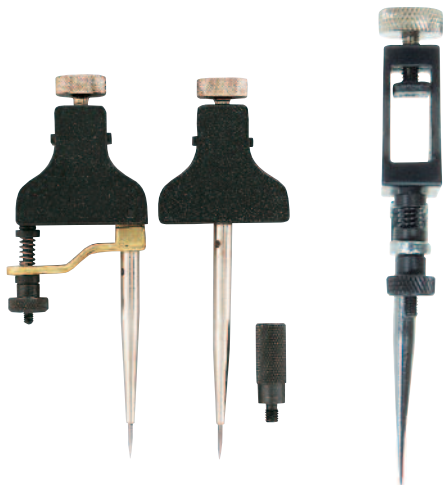

PROFILE VIEW

PRECISION ADJUSTABLE TRAMMELS

- Draw large circles and measure sizable distances with the accuracy of a divider
- Fine adjusting screw sets points accurately
- Points are removable and may be replaced with the pencil holder
- Die-cast bodies with hardened and ground 3" (76mm) needlepoint legs
- Clamp opening for beam is 3/8" x 3/4" (10 x 19mm)
- Conform to government specifications GGG-T-661b

UPC	NO.
23090 4	520
31104 7	84P Replacement points (12 per pkg.)

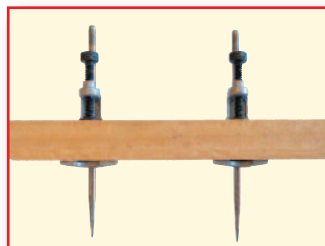

523

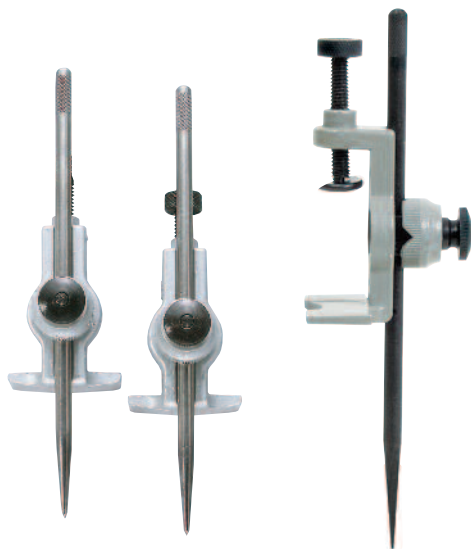

PROFILE VIEW

ADJUSTABLE TRAMMELS

- General's adjustable trammels accurately measure and mark distances that are too great for conventional compasses and dividers
- For layouts, marking templates, and drawing large circles
- 6" (153mm) eccentric points provide fine adjustments
- Points can be replaced with pencils, ballpoint pens, crayons, or soapstone sticks for marking various materials
- Clamps onto beam 5/8" to 1-1/2" (16 to 38mm) thick of any length

UPC	NO.
23093 5	523



524

PROFILE VIEW

PRECISION TRAMMEL SET

- Will accurately transfer measurements, scribe arcs, and lay out circles too large for conventional compasses
- Will fit any scale, 1/2" to 1-1/8" (13 to 29mm) wide
- Two scriber points and two pencil points included
- Up to four points can be stored in body
- Free-wheeling thimble for greater precision
- Aluminum knurled body
- Steel collet holds replacement leads, scribes and crayons
- Points reverse into body for safety
- Ruler not included in set

UPC	NO.
23095 9	524

Scratch Awl & Blade Sharpener



General's Scratch Awl is made from the finest materials for long life. This tool is designed for scribing and layout work, starting screw holes and piercing soft materials.

The Chisel/Plane Blade Sharpener keeps blades razor sharp. The graduated settings maintain the correct 30° cutting angle necessary for these blades.

"ORIGINAL" DRILL GRINDING ATTACHMENT

- Engineered to permit sharpening of drill bits to factory accuracy
- Extends the life of drill bits
- Angle adjustments lock in to grind drill bits for more accurate drilling in a variety of materials
- Automatically adjusts to give correct clearance angle
- For use with ANSI, OSHA, and UL approved standard electric bench grinders or surface grinders
- Equally at home in machine shop and home workshop
- Instructions included

UPC	NO.	CAPACITY
24070 5	825	Fractional drills 1/8" to 3/4", Number size drills 30 to 1 Letter size drills A to Z, Millimeter size drills 3.0 to 19.0

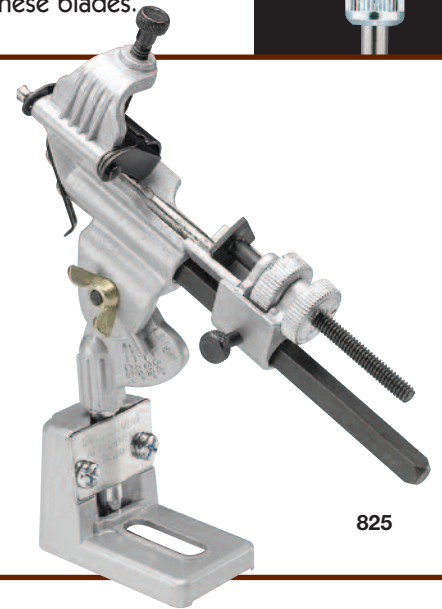

825

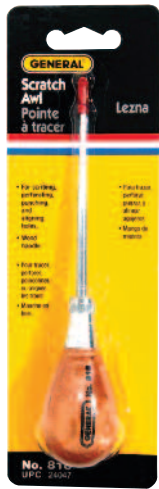

HARDWOOD HANDLE SCRATCH AWL

- Alloy steel blade runs through the handle and is securely fastened to both the plated steel ferrule and the cap
- Hardwood fluted handle is contoured for comfortable grip

UPC	NO.	A	B
24047 7	818	6-1/2" (165mm)	3-3/4" (95mm)

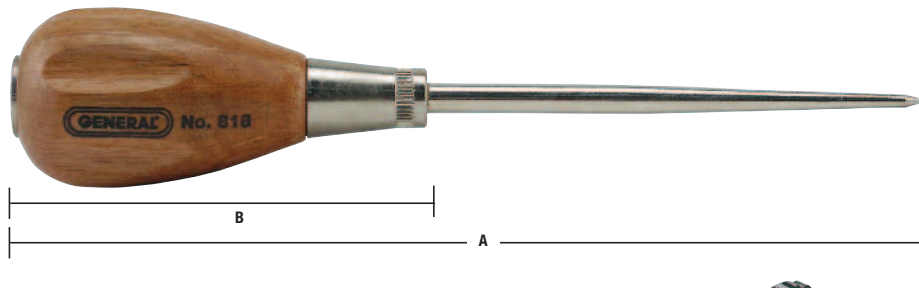

818

CHISEL/PLANE BLADE SHARPENER

- Keeps chisel and plane blades razor sharp
- Graduated settings maintain correct 30° cutting angle on chisel or plane blade
- Spring clamp locks in blades up to 2-5/8" (67mm) wide
- Made of high impact fiberglass reinforced Lexan®
- Folds for storage

UPC	NO.
24024 8	809



809

FIBERGLASS FOLDING RULE

- Constructed of tough, flexible high-impact plastic, with fiberglass reinforcement for added durability
- 72" (1929mm) folding ruler with a 6" (152mm) extension for accurate inside measurements

UPC	NO.	GRADS
25300 2	7200	Outside readings graduated in 16ths.



7200



Whether you're a professional contractor or a conscientious homeowner, General's ultra-sensitive hand-held pin or pinless Moisture Meters help you to easily detect hidden leaks in wood, concrete, plaster and carpet. Available as

both analog and digital models, the Meters provide accurate moisture level readings and are great for new home inspections, locating roof leaks or even selecting dry lumber at the yard.

CE
RoHS
MM1E



PIN-TYPE LED BAR GRAPH MOISTURE METER

Ideal for use in woodworking, building construction and home inspection. Examples include:

- Checking for moisture in carpets and sub-flooring
- Checking wood, drywall and concrete before painting/wallpapering, sealing or treating
- Locating water leaks in roofs, floors and walls
- Selecting dry lumber

FEATURES

- 10-LED display
- Two measurement ranges: 7 to 15% and 16 to 35%
- Protective cap doubles as calibration checker
- Full and low battery indications
- CE and RoHS approved

SPECIFICATIONS

- ◆ Low Measurement Range: 7 to 15% WME (Wood Moisture Equivalent)
- ◆ High Measurement Range: 16 to 35% WME
- ◆ Measurement Accuracy: ± 1 LED (~1%)
- ◆ Calibration Check Point: 21% $\pm 1\%$
- ◆ Low Battery Level: <7.5V

- ◆ Current Consumption: <15mA
 - ◆ Operating Temperature: 32° to 140°F (0° to 60°C)
 - ◆ Storage Temperature: 23° to 140°F (-5° to 60°C)
 - ◆ Dimensions: 6.5 x 2.7 x 1 in. (164 x 69 x 26mm)
 - ◆ Weight: 3.2 oz. (91g) w/out battery
 - ◆ Power Source: 1 "9V" battery (included)
- Includes:**
- Protective cap
 - Battery
 - User's manual

UPC	NO.
10188 9	MM1E

CE
MMD4E



PIN-TYPE LCD MOISTURE METER

Ideal for use in woodworking, building construction, home inspection, lumber selection, water-damage restoration.

FEATURES

- 99.9 count LCD w/0.4 in. high digits
- Wood/building materials selection switch
- Low, Medium and High moisture sounds and on-screen icons
- High accuracy and resolution
- Data hold + auto power off + low battery indicator
- Replaceable stainless steel pins (#PIND4E)
- Powered by "9V" battery (included)

SPECIFICATIONS

- ◆ Overall Moisture Measurement Range: 5 to 50% for wood, 1.5 to 33% for building materials
- ◆ Wood Moisture Scales: 5 to 11.9% (low); 12 to 15.9% (medium); 16 to 50% (high)

- ◆ Building Materials Scales: 1.5 to 16.9% (low); 17 to 19.9% (medium); 20 to 33% (high)
 - ◆ Measurement Accuracy: $\pm 3\%$ of reading
 - ◆ Measurement Resolution: $\pm 0.1\%$
 - ◆ Low Battery Level: <7.5V
 - ◆ Auto Power Off Trigger: 3 minutes of inactivity
 - ◆ Current Consumption: <15mA
 - ◆ Power Source: 1 "9V" battery (included)
- Includes:**
- Protective cap
 - Battery
 - User's manual

UPC	NO.
41447 7	MMD4E
01499 8	PIND4E Replacement pins

CE
RoHS
MMD5NP



PINLESS NON-INVASIVE LCD MOISTURE METER

Ideal for measuring moisture content of wood and other construction materials.

FEATURES

- Non-invasive measurement technique
- Jumbo display
- Wide measurement range
- Intuitive on-screen icons: Low/Medium/High moisture content; wood/concrete mode
- Hold function
- Audible peak reading alert
- Auto-calibrating
- Auto Power Off
- Low and very low battery warnings

SPECIFICATIONS

- ◆ Measurement Ranges: 0 to 99.9% WME (Wood Moisture Equivalent) for wood; 0 to 56.5% for building materials

- ◆ Measurement Accuracy/Resolution: $\pm 3\%/0.1\%$
- ◆ Measuring Depth: 3/4 in. (20mm)
- ◆ Display Type/Size: 99.9 count LCD with 0.4 in. (10mm) high digits
- ◆ Auto Power Off Trigger: 3 to 4 minutes with 0% reading
- ◆ Low/Very Low Battery Warning Triggers: <7.5V/<6.5V
- ◆ Operating Temperature: 32° to 122°F (0° to 50°C)
- ◆ Operating Relative Humidity: <80%
- ◆ Power Source: 1 "9V" battery (included)

- Includes:**
- Battery
 - User's Manual

UPC	NO.
40142 2	MMD5NP

DIGITAL & LED MOISTURE METER

Use to measure moisture content in wood, timber and concrete.

FEATURES

- Two displays: Red LED bar graph and LCD display with 0.62 in. (51mm) high digits
- Optional remote probe available
- Replaceable 0.44 in. (11mm) long pins
- Min/Max memory + data hold
- Data Hold feature freezes displayed reading
- Heavy-duty housing
- Built-in low battery indicator
- Dimensions: 8.4 x 2.7 1.2 in. (216.5 x 68.5 x 29.7mm)
- Weight: 8.8 oz. (251g)

SPECIFICATIONS

- ◆ Two measurement ranges: 0 to 100% for concrete and non-wood materials, 6 to 40% moisture for wood
- ◆ Measurement Accuracy: ± (5% of reading + 5 digits)
- ◆ Power Source: 1 "9V" battery (not included)
- Includes:** • Extra pins • Protective cover • User's manual

UPC	NO.
07003 1	MMD7003
01255 0	MP7003 External Pin-Type Probe (optional)

MMD7003



PIN-TYPE LED BAR GRAPH MOISTURE METER W/REMOTE PIN-TYPE PROBE

Precision instrument for accurate moisture reading in wood and timber.

FEATURES

- 1% Accuracy
- Multi-color LED bar graph readout
- 5.5 to 99.9% measurement range with 0 to 1 VDC output
- Protective cap for safe carrying and operation
- Auto temperature compensation and calibration adjustment
- Stores/recalls up to 99 readings + Min/Max
- Ergonomic design, comfortable and durable
- Convertible to non-invasive measuring by adding optional MP7002 probe
- Audible alarm when preset exceeded
- Audible and visual low battery warning
- Additional set of long pins 0.9 in. (23mm) included
- CE and RoHS approved

SPECIFICATIONS

- ◆ Measuring Range: 5.5 to 99.9% H₂O %WME
- ◆ Accuracy (at 25°C): ±1% Wood Scale
- ◆ Indicator: LED bar graph
- ◆ Color Codes: Green (<16%) Yellow/Red (>21%)
- ◆ Signal Output: 0 to 1 VDC (10mV/%WME)
- ◆ Calibration: Automatic Temperature Compensation
- ◆ Built-in Calibration Adjustment
- ◆ Power Source: 1 "9V" battery (included)
- Includes:**

- 1 MM70 Meter with 0.5 in. (12.7mm) pins
- 1 MP7021 External Pin-Type Probe 39 in. (1m) long with 0.5 in. (12.7mm) pins
- Additional Set of Interchangeable Long Pins 0.9 in. (23mm)
- Protective Fabric Carrying Case
- Battery
- User's manual

UPC	NO.
07020 8	MM70
70604 6	MP7021 External Pin-Type Probe 39 in. (1 meter) long
07070 3	MP7022 External Roller-Type Probe 39 in. (1 meter) long (optional)



CE
RoHS
MM70

PIN-TYPE LCD MOISTURE METER W/ REMOTE PIN-TYPE PROBE

Precision digital instrument for making accurate moisture measurements in wood and timber.

FEATURES

- 1% Accuracy
- Digital LCD display with luminescent back-light
- Protective cap for safe carrying and operation
- Hardened gloss treatment on display-window for an abrasion-proof long-term clean lens
- 5.5% to 99.9% measurement range with 0 to 1 VDC output
- Stores/recalls up to 99 readings + Min/Max
- Auto temperature compensation and internal calibration
- Auto power off
- Ergonomic design, comfortable and durable
- Audible and visual low battery warning
- Interchangeable extension probe
- Additional set of long pins 0.9 in. (23mm) included
- CE and RoHS approved

- ◆ Display: Digital dual LCD display, with multi-function indicator
- ◆ Sampling Rate: 0.3 seconds
- ◆ Wood Group Scales: Select from 8 wood species groups
- ◆ Data Memory: 99 readings
- ◆ Signal Output: 0 to 1 VDC (10mV/%WME)
- ◆ Calibration: Built-in calibration adjustment
- ◆ Battery Life: About 250 hours of continued use with backlight off
- ◆ Operating Temperature: -4° to 131°F (-20° to 55°C) @<80% RH
- ◆ Dimensions: 6.0 x 2.2 x 1.26 in. (153 x 56 x 32mm)
- ◆ Weight: 5.5 oz. (155g) including battery
- ◆ Power Source: 1 "9V" battery (included)

UPC	NO.
07010 9	MM70D
70604 6	MP7021 External Pin-Type Probe 39 in. (1 meter) long
07070 3	MP7022 External Roller-Type Probe 39 in. (1 meter) long (optional)



CE
RoHS
MM70D

Includes:

- 1 MM70D Meter with two 0.5 in. (12.7mm) pins
- 1 MP7021 External Pin-Type Probe 39 in. (1m) long with 0.5 in. (12.7mm) pins
- Additional Set of Interchangeable Long Pins 0.9 in. (23mm)
- Protective Fabric Carrying Case
- Battery • User's manual

SPECIFICATIONS

- ◆ Measuring Range: 5.5 ~ 99.9% H₂O % WME
- ◆ Resolution: 0.1%
- ◆ Accuracy (at 25°C): ±1% Wood scale



“Man is a tool using animal. Weak in himself and of small stature, he stands on a basis of some half-square-foot, and has to straddle out his legs lest the very winds supplant him. Nevertheless, he can use tools, can devise tools; with these the granite mountains melt into light dust before him; seas are his smooth highways, winds and fire his unwearying steeds, Nowhere do you find him without tools. Without tools he is nothing, but with tools he is all.”

Thomas Carlyle (1795–1881)

“It’s Your Job . . . General Tools Make It Easier”

GENERAL TOOLS & INSTRUMENTS • 80 White Street, New York, NY 10013-3567

PHONE (212) 431-6100 • FAX (212) 431-6499 • TOLL FREE (800) 697-8665

e-mail: gentools@generaltools.com

www.generaltools.com

Catalog No. WWJ11

©2011 GENERAL TOOLS & INSTRUMENTS

Not responsible for typographical errors.

Printed in USA 6/11 2.5M

