

Model No. HEL20-4K-BZ  
Mfr. SKU 103-04100003-1

**PROBRITE™**

**HELIOS LED  
CEILING/CANOPY**

**INSTALLATION,  
USAGE, & CARE GUIDE**



**Questions? / Missing Parts? / Need Accessories?**

Before returning to the store, call or email PROBRITE  
Customer Service 9am-5pm EST Monday to Friday.

**1-844-507-5651**

**support@PROBRITE.com**

**PROBRITE.COM**

---

*Visit us online anytime or call us to get information on our product range, download detailed spec & photometric files, find product and mounting accessories, view installation tutorials and videos, and learn about our DLC® rebate eligible products.*

## Table of Contents

<b>Table of Contents</b> .....	<b>2</b>	Package Contents.....	4
<b>Safety Information</b> .....	<b>2</b>	<b>Installation</b> .....	<b>5</b>
<b>Pre-Installation</b> .....	<b>3</b>	<b>Operation</b> .....	<b>9</b>
Planning Installation.....	3	<b>Care &amp; Cleaning</b> .....	<b>9</b>
Specifications.....	3	<b>Troubleshooting</b> .....	<b>10</b>
Tools Required.....	3	<b>Warranty</b> .....	<b>10</b>
Hardware Included.....	4		

## Safety Information

### IMPORTANT

THIS PRODUCT MUST BE INSTALLED IN ACCORDANCE WITH THE APPLICABLE NATIONAL ELECTRICAL CODE AND LOCAL BUILDING CODES BY A PERSON FAMILIAR WITH THE CONSTRUCTION AND OPERATION OF THE PRODUCT AND THE HAZARDS INVOLVED.

### PRECAUTIONS

- Please read and understand this entire manual before attempting to assemble, install, or operate this light fixture.
- This light fixture requires a 120-277Volt AC power source.
- Some codes require installation by a qualified electrician.
- This light fixture must be properly grounded.
- Make sure connections are secure using wire nuts, crimp-on lugs or other approved connecting devices
- This light fixture should be installed outdoors to the ceiling.
- This product may contain chemicals known to be hazardous. Thoroughly wash hands after installing, handling, cleaning or otherwise touching the product.

 **WARNING:** Turn the power off at the circuit breaker or fuse. Place tape over the circuit breaker switch and verify power is off at the light fixture.

 **WARNING:** Risk of fire. Keep the lamp heads at least 3 in. (76mm) from combustible materials.

 **CAUTION:** Burn hazard. Allow the light fixture to cool before touching.

 **NOTICE:** Best if not used with a dimming switch. Use a standard ON/OFF switch.

 **NOTICE:** FCC Regulations state that any unauthorized changes or modifications to this equipment not expressly approved by the manufacturer could void the user's authorization to operate this equipment.

 **INFORMATION:** The device is tested and found to comply with Part 15 of the FCC Rules. Operation is subject to two conditions: (1) This device may not cause harmful interference and, (2) this device must accept any interference received, including any interference that may cause undesired operation.

These limits are designed to provide reasonable protections against harmful interference when the equipment is operated in a commercial environment.

## Pre-Installation

### PLANNING INSTALLATION

Before installing the light fixture, ensure that all parts are present. Compare parts with the *Hardware Included* and *Package Contents* sections. If any part is missing or damaged, do not attempt to assemble, install, or operate this light fixture.

Estimated installation time: 20 minutes

### SPECIFICATIONS

MODEL	HELIOS 20W
<b>Lumens (Light Output)</b>	2200 Watts LED
<b>Watts (Power Consumption)</b>	20 Watts LED
<b>Replaces</b>	70 Watt Metal Halide
<b>Lumens/Watts (Efficacy)</b>	110 lumens per watt
<b>Power Requirments (Input Voltage)</b>	120-277VAC
<b>Light Color (CCT)</b>	4000 Kelvins (Bright White)
<b>Dimmable</b>	Non-Dimming

### TOOLS REQUIRED

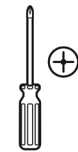

 Phillips Screwdriver



Wire strippers/cutters



Circuit tester



Silicone Sealant



Work gloves



Ladder



Safety goggles

## Pre-Installation (continued)

### HARDWARE KIT



**NOTE:** Hardware *not* shown to actual size.



Part	Description	Quantity
AA	#8-32 x 3/4" philips mounting bracket screw	2
BB	Wire nut	3
CC	Allen key	1

### PACKAGE CONTENTS

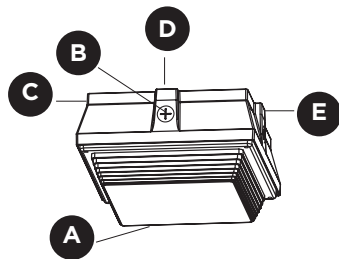

Part	Description	Quantity
A	Light fixture	1
B	Conduit entry plug	4
C	Mounting plate tightening bolt (pre-installed)	1
D	Mounting plate with gasket (pre-installed)	1
E	Hands-free install hook	1

## Installation

### 1 For best results

- The fixture can be mounted in the following two ways:
  - Junction Box Mount:** Use a junction box to mount the fixture.
  - Surface Conduit Mount:** The fixture can also be mounted directly on the wall surface using conduit entry.
- Install light 8-20 feet above the ground.
- When installing two fixtures on one switch, make sure the switch is rated for at least a 1A inductive load.
- Do NOT wire to dimming switch for 20W model.
- Use of 0-10V dimming switch or standard ON/OFF switch for 50W model

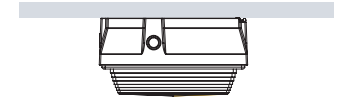

(fig 1). **Ceiling Mount**

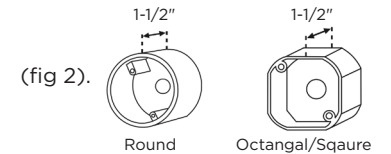

(fig 2).

Round

Octagonal/Square



**NOTE:** Mounting plate (D) mounts to recessed mounted standard junction boxes. Junction box must be at least 1-1/2 inch in depth for proper installation for recessed mount application (fig 2).

### 2 Shut electric power off

- At wall switch verify it is in the off position (fig 1).
- At the main electrical panel turn off the circuit breaker that supplies power to the outlet box you are working on (fig 2).
- For screw-in type fuses unscrew the fuse that supplies power to the outlet box you are working on (fig 3).



(fig 1).

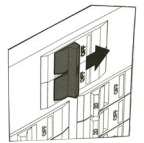

(fig 2).

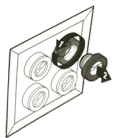

(fig 3).

## Installation (continued)

### 3 Remove the mounting plate

**NOTE:** The mounting plate (D) comes pre-assembled on the light fixture (A) for shipping.

**NOTE:** The mounting plate tightening bolt (C) comes pre-installed on the light fixture.

- Remove the mounting plate (D) from the back of the fixture by loosening the mounting plate tightening bolt (C) using the allen key (CC).

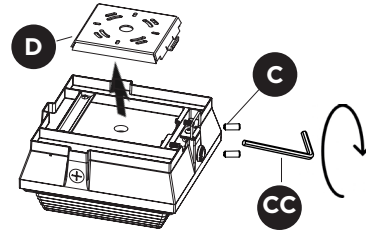

**TIP:** Only unscrew the tightening bolts (C) far enough to remove the mounting plate (D). Do not fully remove the tightening bolts (C).

### 4 Installing the mounting plate

#### Junction box Mount

- Route the junction box wires through the large center hole in the mounting plate (D).
- Align the holes on the mounting plate (D) with the holes on your junction box. Use two #8 screws (AA), depending on the size of the holes in your junction box, attach the mounting plate (D) to your junction box. (Fig. 2)

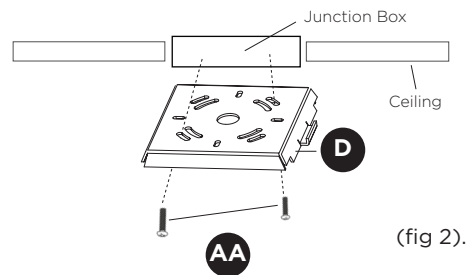

#### Surface Conduit Mount

- Mark and drill two holes on the ceiling surface as per the desired location for fixing the mounting plate (D).
- Use the two or more suitable screws (provided by others) applicable to the mounting surface and secure the mounting plate (D) on the surface. (Fig. 3)

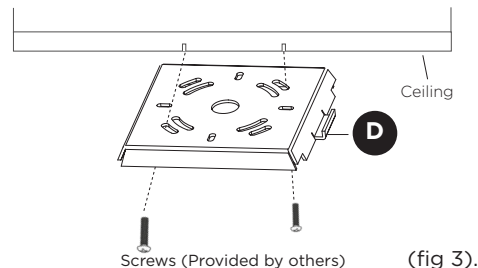

## Installation (continued)

### 5 Making the electrical connections

#### Junction box Mount

- For handsfree operation, use the hook attached to the fixture to hang it on the hinge of the mounting plate (D). (Fig. 1)
- Follow the wiring instructions given below to make the electrical connections. (Fig. 1)

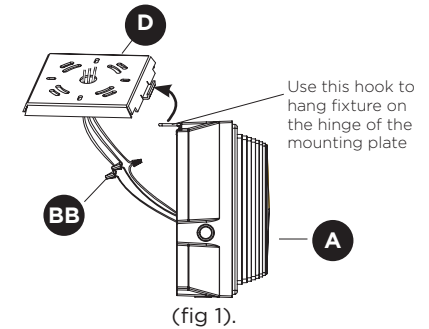

Junction box Mount

#### Surface Conduit Mount

- Open the fixture by loosening the four screws on the corners of the fixture and removing the refractor. (Fig. 2a)
- Remove the refractor from the mounting base by removing the two screws on top of the refractor. ( Fig. 2b)
- Remove one conduit plug from the side of the fixture from where the conduit will enter. (Fig. 3)
- Place the back plate of the fixture on the mounting plate and attach the conduit to the fixture (Fig 4.).
- Bring fixture's wires into the housing body to make wiring connection
- Make wiring connections inside the fixture as per the instructions given below.

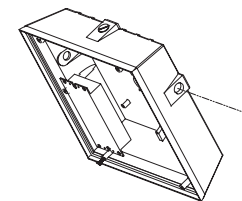
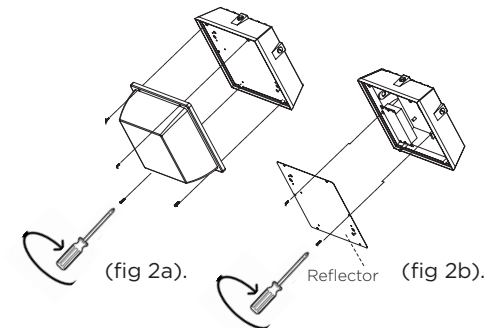

(fig 3).

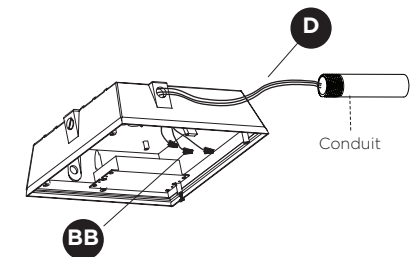

(fig 4).

Surface Conduit Mount

## Installation (continued)

### ON/OFF Wiring (Non Dimming) Method:

- Connect fixture black wire to house black wire, the (+) line, and fixture white wire to house white wire, the (-) common by twisting the exposed wires together and using the wire nuts (BB). Ensure no loose wires.
- Connect house ground wire to the green fixture ground wire, by twisting the exposed wires together and using the wire nuts (BB).

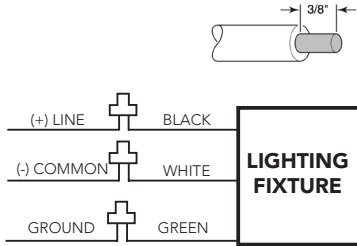

(Non-Dimming Wiring Diagram)



**TIP:** Hold stripped ends near each other and align any frayed strands (do not twist wires).

Push the wires into wire nut (BB) and use your fingers to twist the wire nut clockwise until tight. Check for tightness by pulling wires.

## 6 Mounting the light fixture

### Junction box Mount

- Once the fixture is wired, place the light fixture (A) onto the mounting plate (D) so the top sloped groove on the plate rests on the top sloped groove on the back of the fixture.
- Tighten the mounting plate tightening bolt (C) back through the hole on the bottom of the fixture (A) until the bolt firmly pushes against the mounting plate (D).(fig 1).

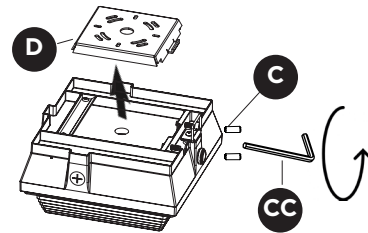

(fig 1).

Junction box Mount

### Surface Conduit Mount

- Replace the reflector on the mounting base by using the two small screws removed earlier. (fig 2a)
- Close the fixture by replacing the reflector and tightening the four screws on the corners of the fixture. (fig 2b).

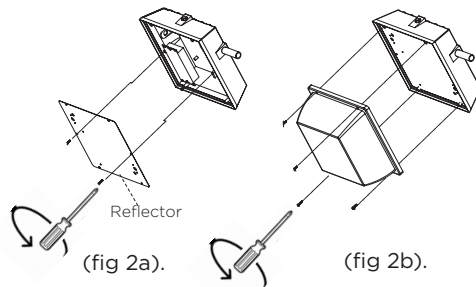

Surface Conduit Mount

## Installation (continued)

## 7 Caulking around the light fixture

- Caulk around the mounting plate (D) and surface with silicone sealant (not included).

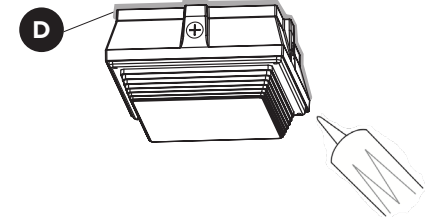

**NOTICE:** Failure to properly caulk around the surface and mounting plate (D) could lead to water damage and is not covered under warranty.



**NOTE:** When attaching this fixture (A) to an external, surface mount junction box, caulk the inside of the light fixture before attaching to the mounting plate (D).

## Operation

### SWITCH-CONTROLLED

Switch-controlled operation enables the light fixture to turn ON and OFF by flipping a standard light switch. To add automatic Dusk to Dawn control or motion sensing, external sensors like a photo-control, motion-sensor or timer is required (*sold separately*).

- Once the fixture is installed, turn power back on from the circuit breaker and switch.
- Flip switch ON and OFF to ensure light functions properly.



**NOTE:** Fixture is non-dimmable, best to not wire to a dimming switch.

### SWITCH



CONTROLLED

## Care and Cleaning

- Shut off main power supply before cleaning the product. To prolong the original appearance, clean the light fixture with clear water and a soft, damp cloth only.
- Do not use abrasive cleaners or cleaners that contain alcohol. Do not apply paints, solvents, or any other chemicals on this light fixture. They could cause a premature deterioration of the finish and may void the warranty.
- Do not spray the light fixture with a hose or power washer.

## Troubleshooting

---

If Light does not come on:

- Verify that the power is turned ON from the circuit breaker and wall switch.
- Verify the wiring for the fixture is done properly.
- Verify the line voltage is correct.

If Light flickers:

- Do not wire to a dimming switch, use a standard ON/OFF switch

## 5-Year Limited Warranty

---

This is a limited warranty offered by Probrite for a period of five years from the date of purchase to its customers. Probrite warrants to customers that the products will be free from defects in material and workmanship. The obligation of Probrite under this warranty is limited to the provision of replacement of products and is extended to the original purchaser of the product on presenting valid purchase receipt or other proof of date of original purchase acceptable to Probrite. The receipt is required for rendering the warranty performance. Any warranty claims without original proof of purchase would not be accepted.

It should be noted that the warranty does not apply to Probrite products that have been altered or repaired by unauthorized personnel, have been subjected to neglect, abuse, misuse or accident or damages caused during shipping. Any other products not manufactured by Probrite which have been supplied, installed and/or used in conjunction with Probrite products are not covered under this warranty. Any damages caused by replacements bulbs, LEDs or corrosion or discoloration of brass components are also not covered by this warranty.

### **Limitation of Liability:**

In no event Probrite shall be liable for indirect, consequential, incidental or special damages, or lost profits. Probrite is not liable for any claims or damage arising out of or connected with the manufacture, sale, delivery, use, maintenance and repair or modification of Probrite products, or supply of any replacement parts that, exceed the purchase price of Probrite products giving rise to a claim. Labor charges to remove or install the fixtures will not be accepted.

### **To Claim:**

Please contact PROBRITE customer service at 1-844-507-5651 or email support@PROBRITE.com and include your name, address and contact number, along with a copy of the purchase receipt and a brief description of the problem.

# **PROBRITE™**

## **Questions? / Missing Parts? / Need Accessories?**

Before returning to the store, call or email PROBRITE  
Customer Service 9am-5pm EST Monday to Friday.

**1-844-507-5651**

**support@PROBRITE.com**

**PROBRITE.COM**

**RETAIN THIS MANUAL FOR FUTURE USE**

**Para las translaciones en español,  
visit [www.probrite.com/install](http://www.probrite.com/install)**