

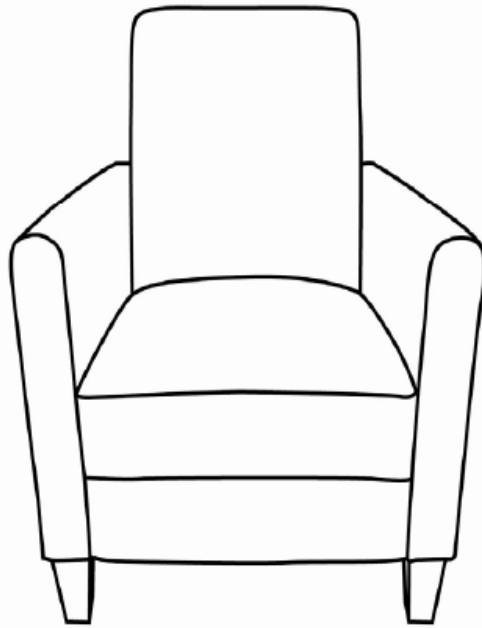

Assembly Instructions

Caution : You must read this before you proceed

Club Chair

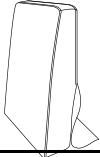

Parts List

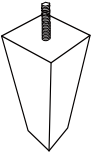
Label	Picture	Description	QTY
A		Chair Backrest	1
B		Chair Base Body	1
C		Wooden Leg	4

Hardware

Label	Picture	Description	QTY
①		Washer Rings	7

Assembly Preparation

Before Beginning Assembly:

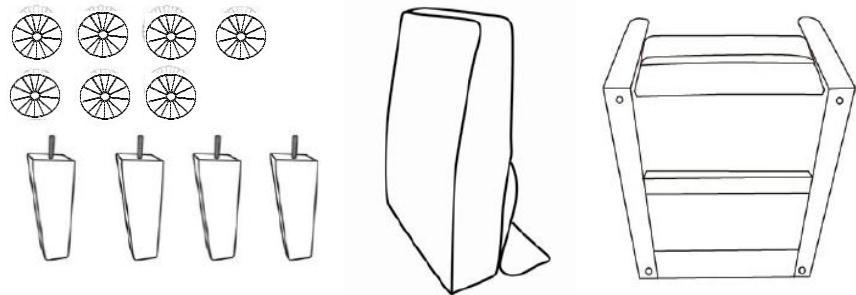

- Read instructions, cover to cover-



- Have 2 adults on hand for assembly-



- Do not assemble on flooring or carpet-



- Assemble on a clean non-marring surface (packing foam)-



- Save all packaging until finished-

Assembly Steps

OVERVIEW

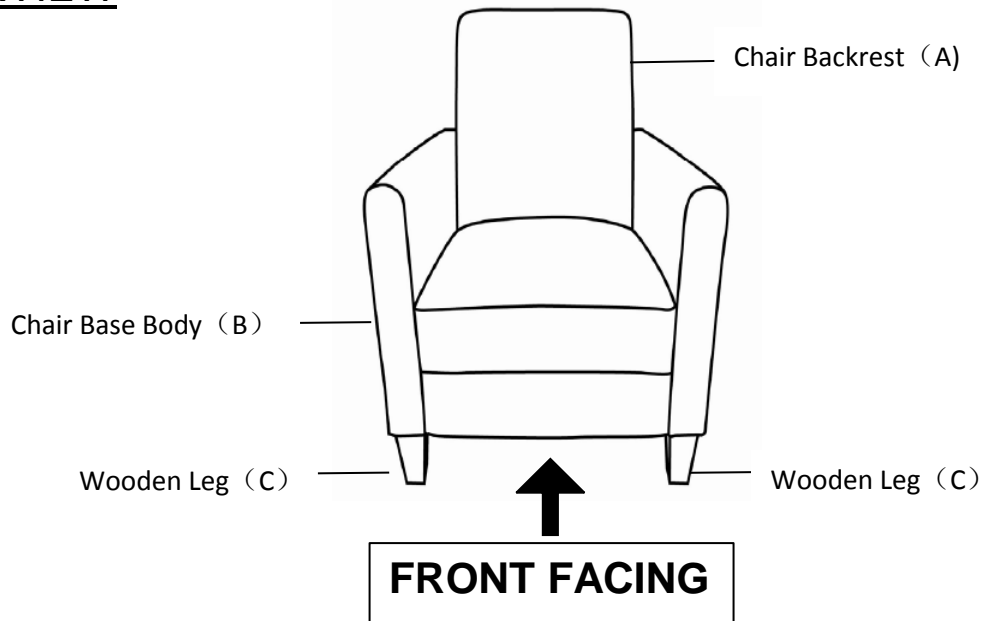

This Reclining Chair has multiple parts and may require up to some 30 minutes to assemble. To give you an overview of the Reclining Chair parts, the above picture is to help you put the various parts into perspective. Please read through the instructions here below to familiarise the parts and steps before assembly.

Step 1

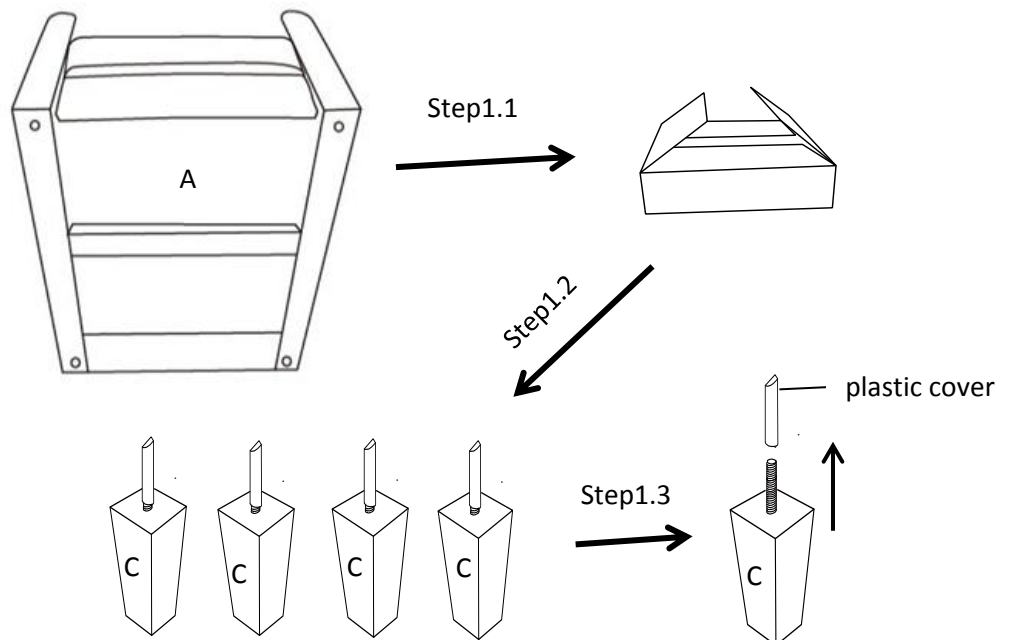

Position the Chair on its back, as shown.

(Perferrably on a surface that won't scratch the upholstery.)

Open the inner box and take out the 4 wooden legs provided, **then remove the plastic covers of Legs.**

Step 2

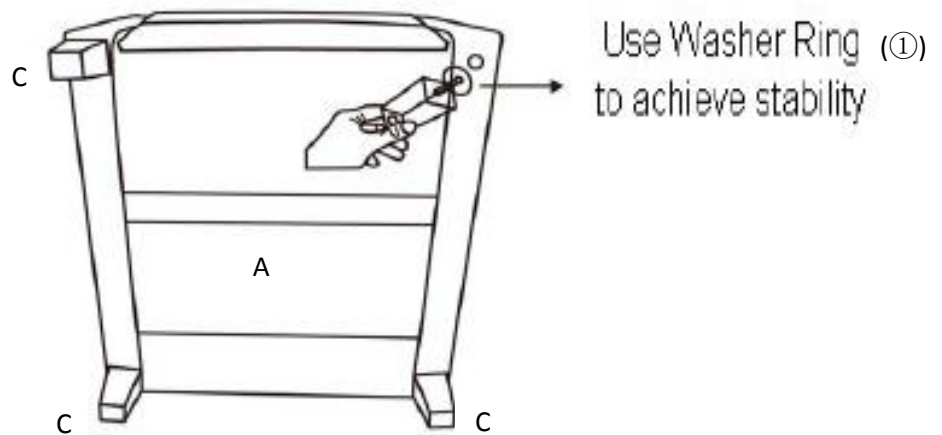

Keep the Chair Base(B) in the same position.

First, install the Front Leg(C) at the bottom of the Chair by placing Washer Ring (1) on the threaded stem.

Then insert threaded stem into the threaded mounting position at the corner of the Chair.

Tighten by turning the Leg clockwise, DO NOT OVER TIGHTEN.

Repeat the same step to install the remaining three Legs(C)

Note: The use of Washer Ring (1) are OPTIONAL and are especially useful to help alleviate slight wobbleness. Some Legs may need more than one Washer Ring (1) whilst some Legs may not need any.

Step 3

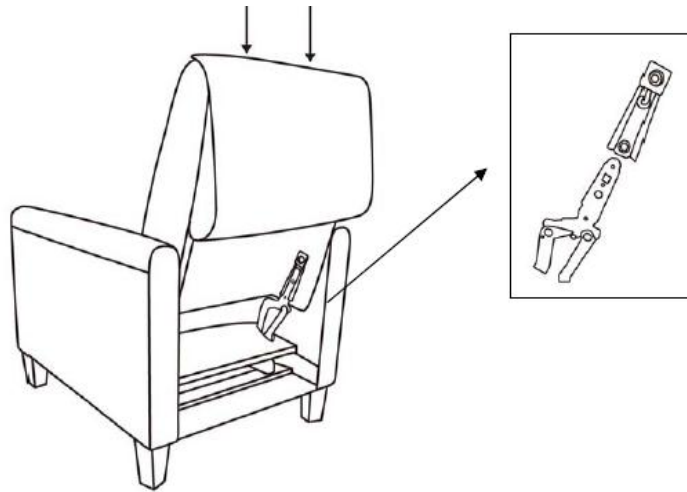

With assistance from your adult partner, hold up the fully assembled Backrest(A) , stand behind the Chair.
Insert the pre-attached Metal Bracket on the sides of the Chair Backrest(B) into the pre-attached slide lock gadget on the Chair Base(B) as shown above.
Firmly but gently, push the Chair Backrest(A) downwards until the **Backrest(A) is fully slotted and locked into position.**

Step 4

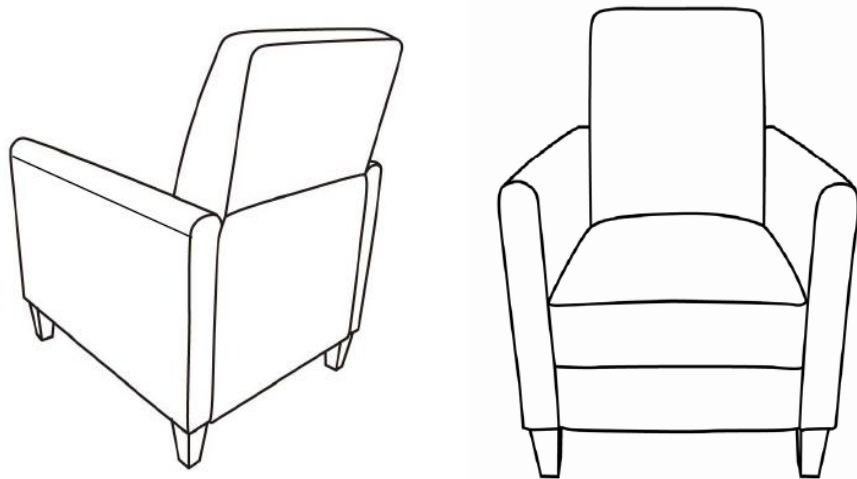

Smooth down the fabric flap on the Chair Backrest.
Run your hands down both sides of the flap, from top to bottom, allowing the velcro tape to adhere to the flap under the seat of the chair.
Your Recliner is ready for use.

Step 5

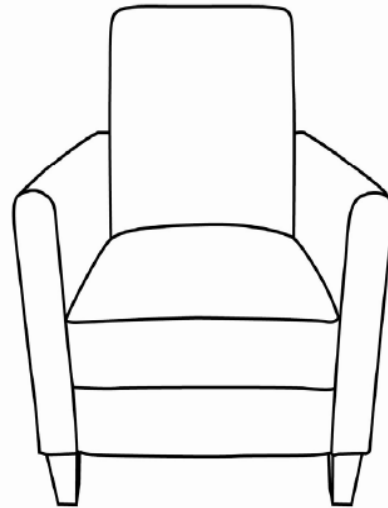

Your Recliner is ready for use.
This Recliner can only be used on a flat, level surface.

Disassembly

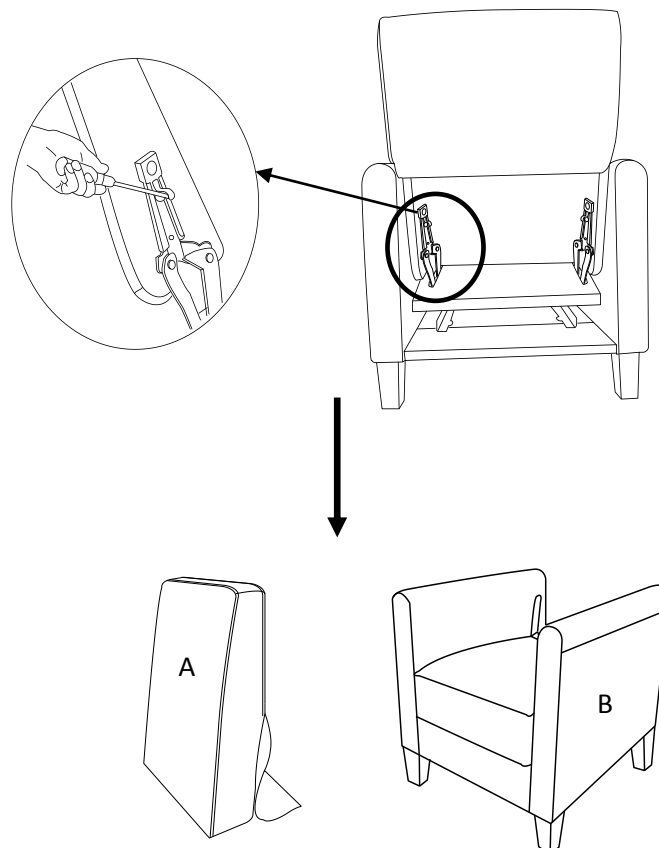

Disassembly Note: Open the flap on the Chair Backrest(A), use a screwdriver (Don't use fingers) pressing outward on the metal ear on the pre-attached Metal Bracket on one side of the Chair Backrest(B).

With assistance of you adult partner to keep the Chair Base(B) in place, pull out the Chair Backrest(A) upward at the same time, repeat the same step for another side.

Then the Chair Backrest(A) can be taken out.

User Instructions.

Recliner Chair

Please read the Instruction Manual below carefully before use.

This is a Recliner Chair. At anytime in a reclined seat position or in the upright position. You may enjoy the rocking motion by using your body weight in a back-front rocking motion.

Supervise children, when in use of this Recliner.

To get into a reclined posture - To Recline backrest

Sit into the seat.

Place your feet apart .

Place your left and right arm onto the armrest.

Synchronise a backward push with your arms.

Use your body weight and push backwards into the seat into a fully reclined position.

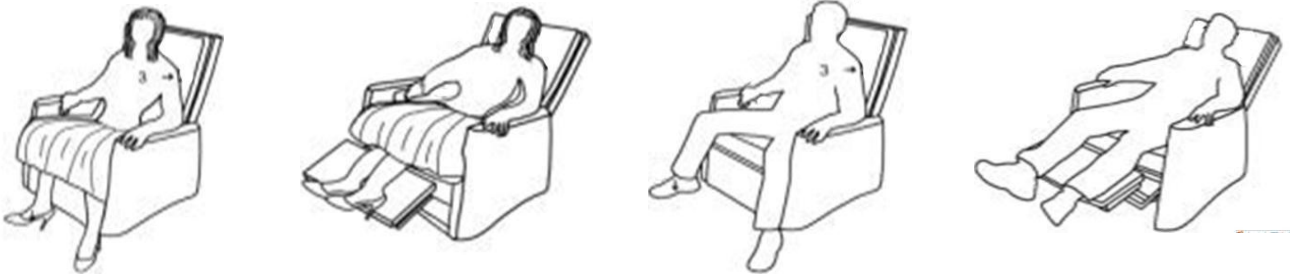

To get out of chair - move Seatback into Upright Position



















Tilt your body weight slightly forward and upwards.



The seat back will come up to an upright position.

Where necessary, use either your arms help lift- push yourself out of the seat.



Care & Maintenance

-   ● Do not put hot items directly on furniture surface
-   ● Do not clean furniture with harsh cleansers or polish.
-   ● Do not place furniture under direct sunlight.
-   ● Do not place furniture near heating or cooling vents.
-   ● Do not write on furniture without a padded barrier to protect the surface.
-   ● Do not place furniture outside . For indoor use only .
-   ● Not for commercial use. For residential use only .
-   ● Stains may be removed with mild soap solution and damp cloth.
-   ● Children should not climb or jump on the furniture.

-
-   ● Dust and pick-up spills using a clean, non-colored, lint-free cloth .

What is Proposition 65?

Proposition 65 is a California law that requires warning labels on products that may contain one of more than 800-plus chemicals or ingredients that the California Office of Environmental Health Hazard Assessment (OEHHA) has deemed to cause cancer or other reproductive toxicity. Chemicals and elements on this list include wood dust, brass, and other everyday substances, which can be found in very common household items, such as: lamps, tableware, jewelry, crystal glasses, electric cords, beauty products, automobiles, and furniture.

Why Did I Find a Proposition 65 Warning on My Home Goods Product?

We include Proposition 65 warnings on all of our products because there is always a chance that one of the 800-plus common chemicals and ingredients listed under this law could potentially be on our furniture or packing materials. We risk large fines under this law, if we don't include this warning.

Should I worry?

We realize you may be worried finding this warning on our products, but we want to reassure you that the hazardous exposure limits for any of these chemicals have never been found on furniture products that we've shipped to our customers. Additionally, this warning label is very common and can be found on almost every piece of furniture sold in the state of California.

Just How Common Are Proposition 65 Warnings?

Proposition 65 warnings have become so common in California that it is hard to take a trip to a local bank, grocery store, or restaurant without finding at least one warning. In fact, even the Disney Land Resort has a Proposition 65 warning:

