

CLIMBING EQUIPMENT



#1 IN LADDERS™



WERNER CLIMBING EQUIPMENT

CLIMBING SOLUTIONS.....	3
CHOOSING THE RIGHT LADDER FOR THE JOB.....	4-5

FIBERGLASS

STEPLADDERS.....	6-21
LEANSAFE.....	9
STEP STOOLS.....	13-14
PODIUM LADDER.....	18-19
MULTILADDERS.....	20-21
EXTENSION LADDERS.....	22-29

ALUMINUM

STEPLADDERS.....	30-35
UTILITY LADDER.....	35
STEP STOOLS.....	37
EXTENSION LADDERS.....	38-42
MULTILADDERS.....	44
WORK PLATFORMS.....	46-47
ATTIC LADDERS.....	48-49
ROLLING SCAFFOLDS.....	50
PLANKS.....	51
PUMP JACKS.....	52
SCAFFOLDING & STAGES.....	54-61

STEEL

PUMP JACKS.....	53
-----------------	----

ACCESSORIES

LOCK-IN SYSTEM.....	62-63
STEPLADDER.....	64
EXTENSION LADDER.....	65-69

LEADING THE WAY IN CLIMBING SOLUTIONS



Once your feet leave the ground, you're in our world. From ladders to fall protection, Werner offers you a full line of climbing equipment that's engineered to provide maximum stability, safety and comfort at every height. Our products are designed to be used anywhere from the home to the most demanding job sites.

We continually strive to improve manufacturing techniques through ongoing testing and facility investment. Recognized for their durability, quality and safety, Werner products are developed based on application, industry research, product testing and customer insight to ensure the highest quality standards that meet the needs of our end users.



LOCKTOP™

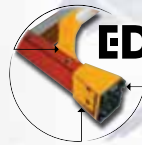

EDGE 360®

Werner remains the market leader today by continually enhancing and improving its product offering. Recently, the Werner 6200 Series Stepladders were redesigned for better performance and productivity, which included an upgraded ladder top and enhanced bracing for overall durability. Our number one professional grade ladder series was upgraded specifically for professional contractors and continues to be a dependable tool on jobsites everywhere.

PRODUCT CERTIFICATIONS

Werner ladders are manufactured and tested to the strictest quality standards. All Werner ladders meet or exceed American National Standards Institute (ANSI) and Occupational Safety and Health Administration (OSHA) requirements, where applicable.



OCCUPATIONAL SAFETY AND HEALTH ADMINISTRATION CODE

All Type II, I, IA and IAA fiberglass, aluminum and wood ladders, ladder jacks and extension planks meet or exceed code. OSHA CODE applies to ladders used in the workplace. Werner Co. recommends Type II or heavier duty rated ladders for these applications.



AMERICAN NATIONAL STANDARDS INSTITUTE

PRODUCT LINES MEET OR EXCEED ANSI CODE

Fiberglass Ladders A14.5 (2017)
Aluminum Ladders A14.2 (2017)
Ladder Jacks A10.8 (2019)
Extension Planks A10.8 (2019)
Scaffolding A10.8 (2019)
Stages A10.8 (2019)
Work Platforms A10.8 (2019)
Attic Ladders..... A14.9 (2019)
Ladder Accessories... A14.8 (2013)
Step Stools A14.11 (2018)

STEP 1 SELECT HEIGHT (SIZE)

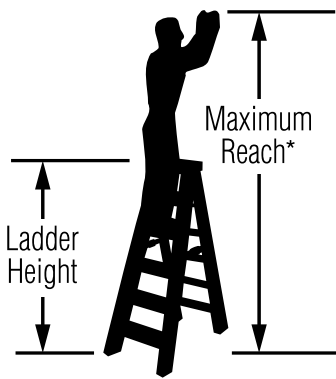

STEPLADDERS	
Ladder Height	Maximum Reach*
4'	8'
6'	10'
7'	11'
8'	12'
10'	14'
12'	16'
14'	18'
16'	20'

Average Heights

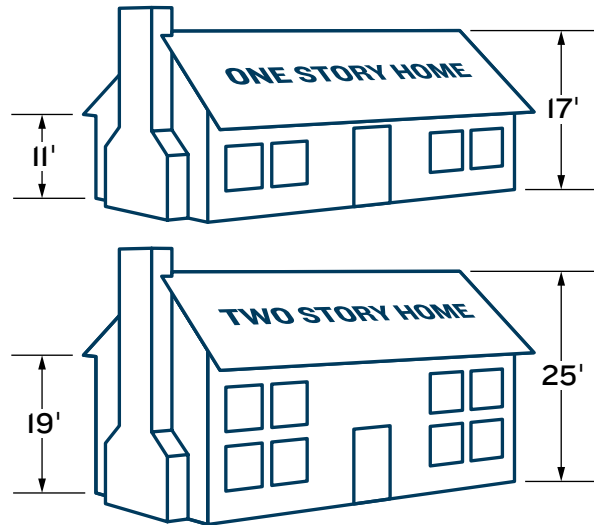

*Assumes a 5'6" person with a vertical 12" reach.

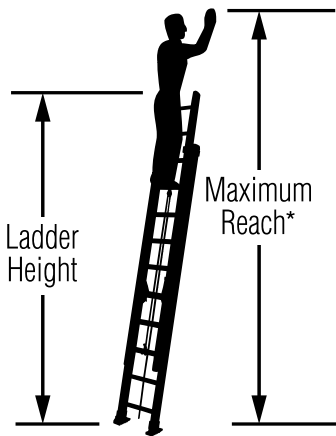

EXTENSION LADDERS		
Ladder Height	Maximum Reach*	Height To Gutter or Top Support Point††
16'	15'	9' max.
20'	19'	9' to 13'
24'	23'	13' to 17'
28'	27'	17' to 21'
32'	31'	21' to 25'
36'	34'	25' to 28'
40'	37'	28' to 31'

†† Support points for extension ladders reflect section overlap, ladder angle, or 3' extension above roof line.

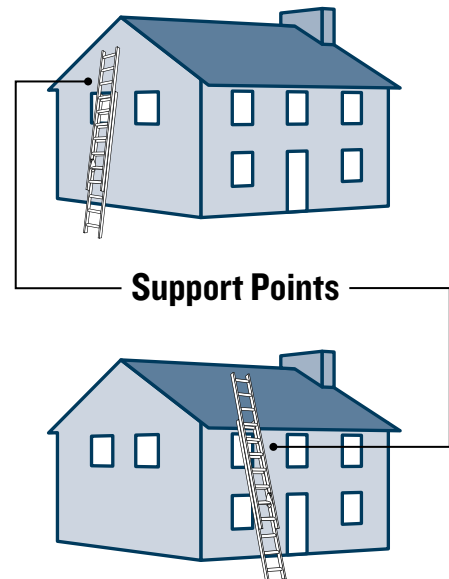

STEP **2** **SELECT PERFORMANCE (DUTY RATING)**

200-225lb
LOAD CAPACITY

LIGHT DUTY BASIC DESIGNS

250lb
LOAD CAPACITY

MEDIUM DUTY INNOVATIVE DESIGNS

300lb
LOAD CAPACITY

HEAVY DUTY RUGGED & DURABLE

375lb
LOAD CAPACITY

COMMERCIAL GRADE MOST DURABLE

STEP **3** **SELECT MATERIAL**



NON CONDUCTIVE FOR WORKING NEAR ELECTRICITY



DESIGNED AND TESTED FOR EXTREME TEMPERATURES



WON'T DENT, SHATTER, RUST OR CORRODE



HIGH VISIBILITY COLOR



NOT FOR USE NEAR ELECTRICITY



DESIGNED AND TESTED FOR EXTREME TEMPERATURES



WON'T DENT, SHATTER, RUST OR CORRODE



7400SERIES Platform Stepladder

375lbs. LOAD CAPACITY

TYPE IAA
DUTY RATING



* Energy Diffusing Geometry

- Every rivet backed up by metal plate or washer to protect rails

SPECIFICATIONS

Model No.	Size	Approx. Width	Approx. Spread	Approx. Cu. Ft. Per Unit	Approx. Shipping Wt. Lbs.
7403	3'	19-3/4"	24-3/8"	2.5	13.5
7404	4'	21-1/2"	30-1/2"	3.5	16.5
7405	5'	23-1/4"	36-3/4"	4.6	20.0
7406	6'	25"	42-7/8"	5.8	23.5
7407	7'	26-3/4"	49"	7.1	28.0
7408	8'	28-1/2"	55-1/4"	8.5	32.0
7410	10'	32"	67-1/2"	11.4	40.5
7412	12'	35-1/2"	79-7/8"	14.8	49.5

DIMENSIONS

Top:	7-1/4" x 14-7/8"	Steps:	3" wide
Front Rails:	3-1/8" wide	Rear Rails:	1-7/8" wide
Front Flange:	1-3/16" wide	Rear Flange:	1-3/16" wide

T7400SERIES

Multi-Use Twin Stepladder††

375lbs. LOAD CAPACITY PER SIDE

TYPE IAA
DUTY RATING



* Energy Diffusing Geometry

- Every rivet backed up by metal plate or washer to protect rails

SPECIFICATIONS

NOTE: Type IAA duty rating is for stepladders up to 12 ft.

Model No.	Size	Approx. Width	Approx. Spread	Approx. Cu. Ft. Per Unit	Approx. Shipping Wt. Lbs.
T7404	4'	21-1/2"	36-1/8"	4.5	21.5
T7405	5'	23-1/2"	43-1/8"	5.8	29.0
T7406	6'	25"	50-1/8"	7.3	30.0
T7408	8'	28-1/2"	64-1/8"	10.5	40.5
T7410	10'	32"	78-1/4"	14.2	51.5
T7412	12'	35-1/2"	92-1/4"	18.3	63.5

300lbs. LOAD CAPACITY

TYPE IA
DUTY RATING

T7414	14'	39"	106-1/4"	22.8	86.0
T7416	16'	42-1/2"	120-1/4"	27.7	103.5
T7418	18'	46"	136-1/8"	33.1	126.0
T7420	20'	49-1/2"	150-1/8"	38.8	149.0

†† Designed for one or two person jobs. Note: When used as a double stepladder, the maximum load per side, including person and materials, shall not exceed the duty rating of ladder.

DIMENSIONS

Top:	8-1/4" x 14-1/2"	Steps:	3" wide
Rails:	3-1/8" wide	Flange:	1-3/16" wide

P7400SERIES Platform Stepladder

375lbs. LOAD CAPACITY

TYPE IAA
DUTY RATING



- * Energy Diffusing Geometry
- Every rivet backed up by metal plate or washer to protect rails
- Internal aluminum spreaders on 8' and 10' models

SPECIFICATIONS NOTE: Type IAA duty rating is for platforms ranging in size from 3' to 8'

Model No.	Height (Size) to Platform	Rail Length	Approx. Width	Approx. Spread	Approx. Cu. Ft. Per Unit	Approx. Shipping Wt. Lbs.
P7403	3'	5'	25-1/4"	35-7/8"	5.1	22.0
P7404	4'	6'	27"	42"	6.4	26.0
P7406	6'	8'	30-1/2"	54-3/8"	9.1	34.0
P7408	8'	10'	34"	66-5/8"	12.2	44.5

300lbs. LOAD CAPACITY

TYPE IA
DUTY RATING

P7410	10'	12'	37-1/2"	79"	15.6	54.5
P7412	12'	14'	42"	91-1/4"	19.3	68.5

†† Designed for one or two person jobs. Note: When used as a double stepladder, the maximum load per side, including person and materials, shall not exceed the duty rating of ladder.

DIMENSIONS

Platform:	14-5/8" x 15"	Steps:	3" wide
Front Rails:	3-1/8" wide	Rear Rails:	1-7/8" wide
Front Flange:	1-3/16" wide	Rear Flange:	1-3/16" wide

PT7400/PT7400-4CSERIES Stockr's Ladder®††

300lbs. LOAD CAPACITY PER SIDE

TYPE IA
DUTY RATING

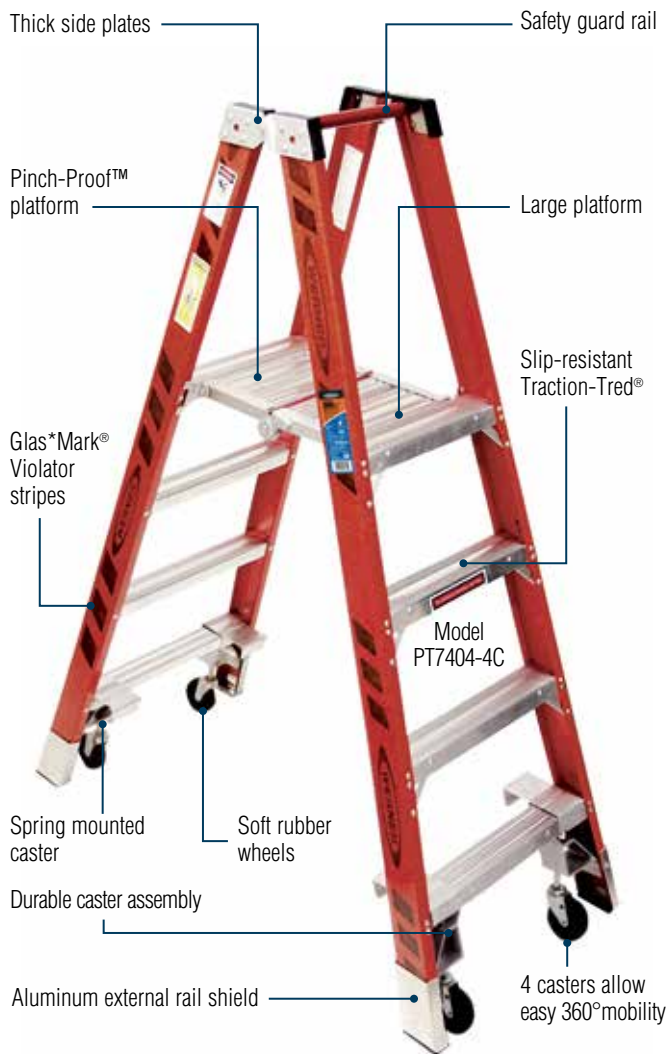

- Easy to handle and folds to a 12" width for storage
- Unique combination of one person, two person†† and platform ladder use
- Internal Pinch-Proof™ aluminum spreaders on 8' and 10' models
- Requires less floor space than heavy steel rolling ladders

SPECIFICATIONS

Model No.	Height (Size) to Platform	Rail Length	Approx. Width	Approx. Spread	Approx. Cu. Ft. Per Unit	Approx. Shipping Wt. Lbs.	Model No. with Casters	Approx. Shipping Wt. Lbs.
PT7404	4'	6'	25-1/4"	50"	8.4	31.0	PT7404-4C	37.0
PT7406	6'	8'	28-3/4"	64"	12.7	41.5	PT7406-4C	53.0
PT7408	8'	10'	32-1/4"	78-1/4"	17.8	54.5	PT7408-4C	60.5
PT7410	10'	12'	35-3/4"	92-1/4"	23.7	66.0	PT7410-4C	72.5

†† Designed for one or two person jobs. Note: When used as a double stepladder, the maximum load per side, including person and materials, shall not exceed the duty rating of ladder.

DIMENSIONS

Platform:	12-3/4" x 22"	Steps:	3" wide
Rails:	3-1/8" wide	Flange:	1-3/16" wide

E7400 SERIES Extension Trestle Ladder††

300lbs. LOAD CAPACITY PER SIDE

TYPE IA
DUTY RATING

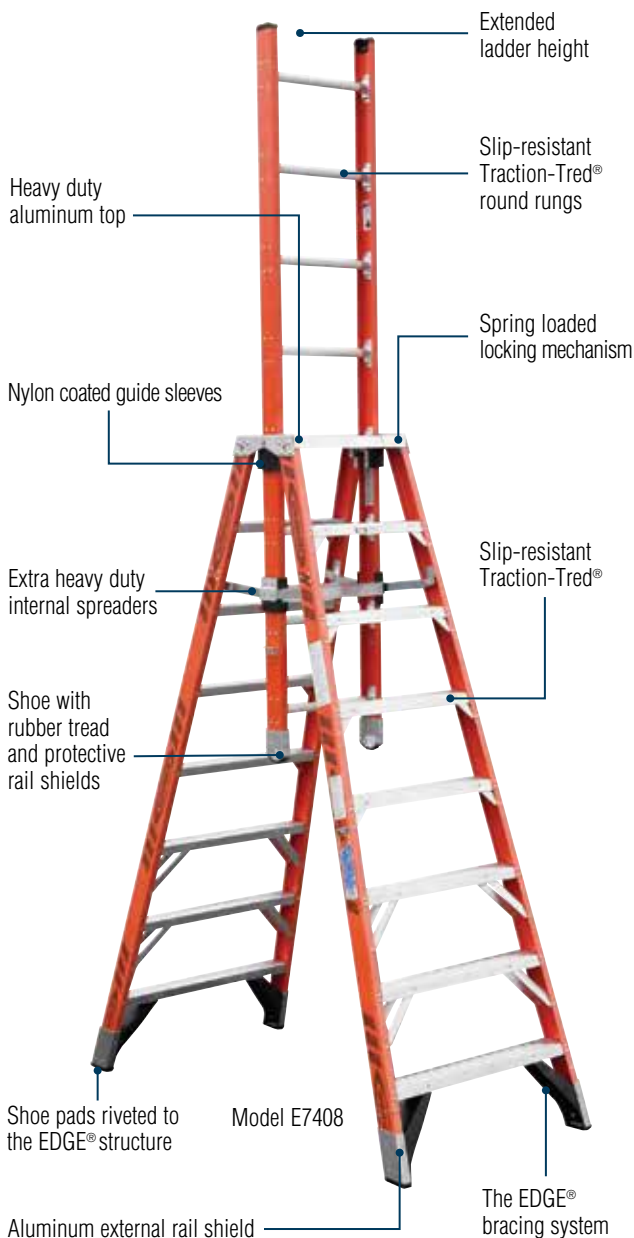

Model E7408

SPECIFICATIONS

Model No.	Stepladder Size	Base Section Bottom Width	Approx. Spread	Approx. Extended Ladder Height	Approx. Cu. Ft. Per Unit	Approx. Shipping Wt. Lbs.
E7408	8'	32-3/4"	67-3/4"	12'	16.6	74.0
E7410	10'	36-1/4"	81-7/8"	15'	22.2	95.5
E7412	12'	39-3/4"	95-7/8"	19'	28.3	113.5
E7414	14'	43-1/4"	109-3/4"	22'	35.1	135.5
E7416	16'	46-3/4"	123-3/4"	26'	42.4	158.0

†† Designed for one or two person jobs. Note: When used as a double stepladder, the maximum load per side, including person and materials, shall not exceed the duty rating of ladder.

DIMENSIONS

Extended Ladder		Stepladder	
Rails:	3-3/8" wide	Rails:	3-3/16" wide (8'-12') 3-5/16" wide (14'-16')
Rungs:	1-1/4"	Steps:	3" wide
Flange:	1-3/16" wide	Flange:	1-3/16" wide

7300 SERIES Stepladder

375lbs. LOAD CAPACITY

TYPE IAA
DUTY RATING



Model 7306

- EDGE360™ features Intergrated Rail Shields, Energy Diffusing Geometry, and Oversized Foot Pads
- Every rivet backed up by metal plate or washer to protect rails

SPECIFICATIONS

Model No.	Approx. Size	Approx. Width	Approx. Spread	Approx. Cu. Ft. Per Unit	Approx. Shipping Wt. Lbs.	Model No. with Pail Shelf	Approx. Shipping Wt. Lbs.
7303	3'	19-3/4"	23-1/2"	2.5	13.0	7303S	16.5
7304	4'	21-1/2"	29-3/4"	3.5	16.0	7304S	19.5
7305	5'	23-1/4"	35-7/8"	4.6	19.5	7305S	23.0
7306	6'	25"	42"	5.8	22.5	7306S	26.0
7308	8'	28-1/2"	54-3/4"	8.5	31.0	7308S	34.0
7310	10'	32"	66-5/8"	11.4	40.5	7310S	43.5
7312	12'	35-1/2"	79"	14.8	50.0	7312S	53.0

DIMENSIONS

Top:	7-1/4" x 14-7/8"	Steps:	3" wide
Front Rails:	3-1/8" wide	Rear Rails:	1-7/8" wide
Front Flange:	1-3/16" wide	Rear Flange:	1-3/16" wide

L7300SERIES Leansafe Ladder

375lbs. LOAD CAPACITY

TYPE IAA
DUTY RATING



- Designed to lean up against walls, corners and poles
- Non-marring rubber pad protects the wall in leaning mode
- LEANSAFE™ ladder top is designed to secure tools and increase productivity
- Front and rear rail are different color for added visual safety
- Rail latch locks legs together when in leaning mode
- Curved foot pads to maximize surface area when in stepladder and leaning mode

SPECIFICATIONS

Model No.	Size	Stepladder Mode		Leaning Mode	
		Max. Standing Height	Max. Reach Height	Max. Standing Height	Max. Reach Height
L7304	4'	1'-8"	8'-4"	10"	7'-3"
L7306	6'	3'-10"	10'	2'-10"	9'
L7308	8'	5'-9"	12'	4'-9"	11'
L7310	10'	7'-8"	14'	6'-8"	13'
L7312	12'	9'-7"	16'	8'-7"	15'

*assumes a 5'-6" person with a vertical 12" reach

L6200SERIES Leansafe Ladder

300lbs. LOAD CAPACITY

TYPE IA
DUTY RATING



- Designed to lean up against walls, corners and poles
- Non-marring rubber pad protects the wall in leaning mode
- LEANSAFE™ ladder top is designed to secure tools and increase productivity
- Front and rear rail are different color for added visual safety
- Rail latch locks legs together when in leaning mode
- Curved foot pads to maximize surface area when in stepladder and leaning mode

SPECIFICATIONS

Model No.	Size	Stepladder Mode		Leaning Mode	
		Max. Standing Height	Max. Reach Height	Max. Standing Height	Max. Reach Height
L6204	4'	1'-8"	8'-4"	10"	7'-3"
L6206	6'	3'-10"	10'	2'-10"	9'
L6208	8'	5'-9"	12'	4'-9"	11'
L6210	10'	7'-8"	14'	6'-8"	13'
L6212	12'	9'-7"	16'	8'-7"	15'

*assumes a 5'-6" person with a vertical 12" reach





THE BEST TOPS IN THE INDUSTRY



Next generation ladder top holds an arsenal of tools



Customize your ladder top with the Lock-In Accessory System



Sturdy paint can hanger decreases chances of spilling



Keeps tools within easy reach with the HolsterTop®



Convenient pail shelf provides additional work surface



6200SERIES Stepladder

300lbs. LOAD CAPACITY

TYPE IA
DUTY RATING



COMPATIBLE
SEE PAGES 59-60



4 rivets attach top to each front rail

Next generation ladder top holds an arsenal of tools

Back-up plates

Double riveted, slip-resistant Traction-Tred®

Full set of rear horizontals

Heavy duty internal spreaders

Model 6206

All steps and two rear horizontals are knee-braced

EDGE360™ bracing system

- EDGE360™ features Intergrated Rail Shields, Energy Diffusing Geometry, and Oversized Foot Pads
- Every rivet backed up by metal plate or washer to protect rails
- Optional yellow molded pail shelf kit, model no. 76-2

SPECIFICATIONS

Model No.	Size	Approx. Width	Approx. Spread	Approx. Cu. Ft. Per Unit	Approx. Shipping Wt. Lbs.
6203	3'	18-1/8"	23-1/8"	2.0	13.0
6204	4'	19-7/8"	29"	3.0	16.0
6205	5'	21-5/8"	35-1/8"	4.1	19.0
6206	6'	23-3/8"	41-1/4"	5.3	22.0
6207	7'	25-1/8"	47-1/2"	6.6	26.0
6208	8'	26-7/8"	53-5/8"	8.1	30.0
6210	10'	30-3/8"	65-7/8"	12.5	39.0
6212	12'	33-7/8"	78-1/4"	15.0	48.0

DIMENSIONS

Top:	5-3/4" x 13"	Steps:	3" wide
Front Rails:	3-1/8" wide	Rear Rails:	1-7/8" wide
Front Flange:	1-3/16" wide	Rear Flange:	1-3/16" wide

T6200SERIES Twin Stepladder††

300lbs. LOAD CAPACITY PER SIDE

TYPE IA
DUTY RATING

C6200SERIES Compact Stepladder

300lbs. LOAD CAPACITY

TYPE IA
DUTY RATING

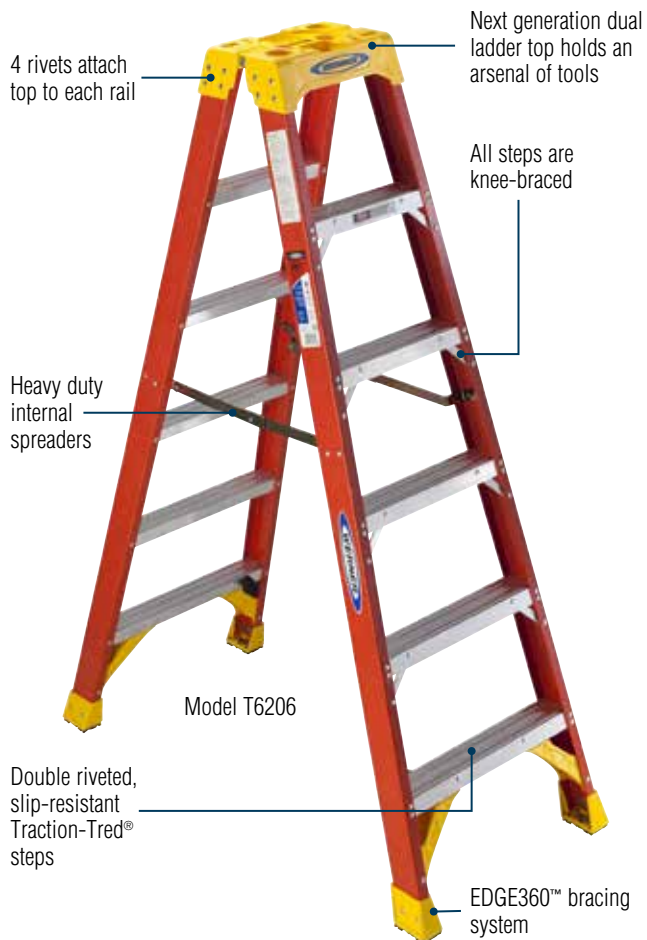

Model T6206



Model C6204

- EDGE360™ features Intergrated Rail Shields, Energy Diffusing Geometry, and Oversized Foot Pads
- Every rivet backed up by metal plate or washer to protect rails

- Lightweight and compact slim design makes it easy to maneuver around corners and tight spaces
- The lightweight fiberglass construction makes it easy to carry and store

* On 5ft and above models

SPECIFICATIONS

Model No.	Size	Approx. Width	Approx. Spread	Approx. Cu. Ft. Per Unit	Approx. Shipping Wt. Lbs.
T6203	3'	18-1/8"	29"	3.1	16.0
T6204	4'	19-7/8"	36-1/8"	4.6	19.0
T6205	5'	21-5/8"	43-1/8"	6.2	23.0
T6206	6'	23-3/8"	50-1/8"	8.0	27.0
T6208	8'	26-7/8"	64-1/8"	12.3	37.0
T6210	10'	30-3/8"	78-1/8"	17.3	54.5
T6212	12'	33-7/8"	92-1/8"	23.2	68.5

††Designed for one or two person jobs. Note: When used as a double stepladder, the maximum load per side, including person and materials, shall not exceed the duty rating of ladder.

DIMENSIONS

Top:	8-1/2" x 13"	Steps:	3" wide
Rails:	3-1/8" wide	Flange:	1-3/16" wide

SPECIFICATIONS

Model No.	Top Platform Height	Max. Reach	Compact Ladder Height	Comparable Stepladder Height	Approx. Shipping Wt. Lbs.
C6204	1' 11"	8'	3.5'	4'	11
C6205	2' 10"	9'	4.5'	5'	15
C6206	3' 9"	10'	5.5'	6'	18
C6207	4' 8"	11'	6.5'	7'	20
C6208	5' 8"	12'	7.5'	8'	22

DIMENSIONS

Platform:	10.5" x 13"	Steps:	3" wide
Front Rails:	17" wide	Rear Rails:	1-1/4" wide
Front Flange:	3/4" wide	Rear Flange:	1" wide



P6200SERIES Platform Ladder

300lbs. LOAD CAPACITY PER SIDE

TYPE IA
DUTY RATING



Model P6206

- EDGE360™ features Intergrated Rail Shields, Energy Diffusing Geometry, and Oversized Foot Pads
- Every rivet backed up by metal plate or washer to protect rails
- Internal aluminum spreaders on 8' and 10' models

SPECIFICATIONS

Model No.	Height (Size) to Platform	Rail Length	Approx. Width	Approx. Spread	Approx. Cu. Ft. Per Unit	Approx. Shipping Wt. Lbs.
P6202	2'	4'	23-3/8"	29-3/4"	4.2	17.0
P6204	4'	6'	26-7/8"	42"	7.2	24.0
P6206	6'	8'	30-3/8"	54-3/4"	10.9	32.0
P6208	8'	10'	33-7/8"	66-5/8"	15.2	44.5
P6210	10'	12'	37-3/8"	79"	20.1	55.0

DIMENSIONS

Platform:	14-5/8" x 15"	Steps:	3" wide
Front Rails:	3-1/8" wide	Rear Rails:	1-7/8" wide
Front Flange:	1-3/16" wide	Rear Flange:	1-3/16" wide

FTP6200SERIES Tripod Stepladder

300lbs. LOAD CAPACITY

TYPE IA
DUTY RATING

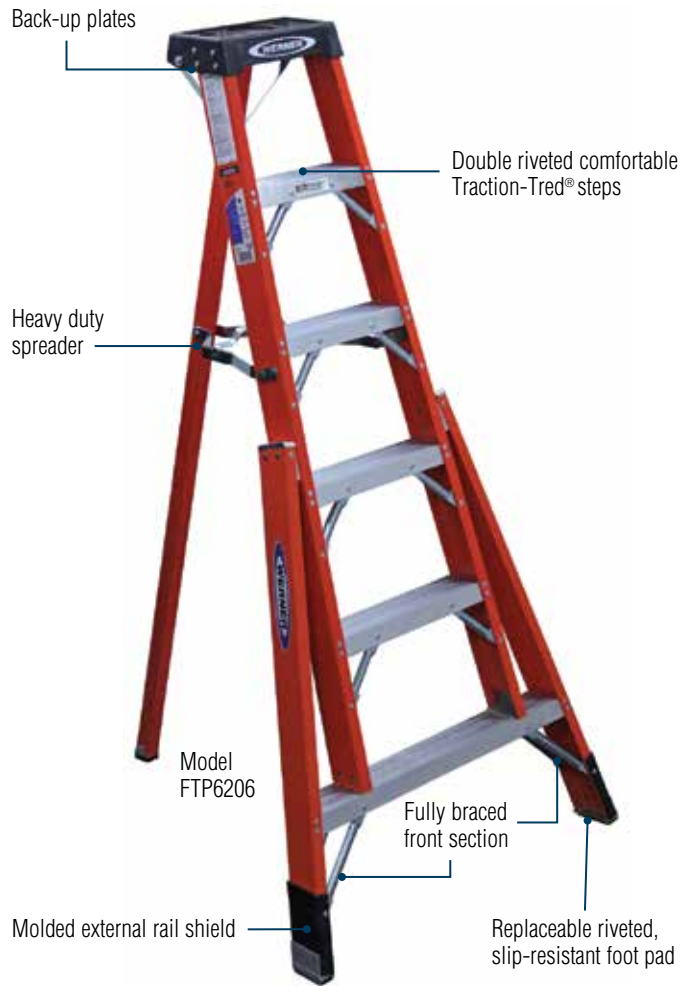

Model FTP6206



Single rear rail allows FTP Series to rest where other ladders can't

Convenient spreader handle design improves setup and transportability

Makes working in tight spaces easy

- Every rivet backed up by metal plate or washer to protect rails
- Internal aluminum spreaders on 8' and 10' models

SPECIFICATIONS

Model No.	Size	Approx. Width	Approx. Spread	Approx. Cu. Ft. Per Unit	Approx. Shipping Wt. Lbs.
FTP6204	4'	31"	30-1/2"	3.7	17.0
FTP6206	6'	36"	43-3/4"	6.8	23.0
FTP6208	8'	40"	57"	10.1	31.0
FTP6210	10'	51"	71"	17.6	42.0
FTP6212	12'	54"	77-3/4"	22.6	51.0

DIMENSIONS

Top:	5-3/4" x 13"	Steps:	3" wide
Front Rails:	3-1/8" wide	Rear Rail:	1-1/2" square (4' to 8'), 2" square (10' and 12')
Flange:	1-3/16" wide		



6202MODEL Step Stool

300lbs. LOAD CAPACITY

TYPE IA
DUTY RATING



SPECIFICATIONS

Model No.	Size	Approx. Width	Approx. Spread	Approx. Cu. Ft. Per Unit	Approx. Shipping Wt. Lbs.
6202	2'	17-1/4"	19-1/2"	1.4	9.0

DIMENSIONS

Top:	7" x 12-3/8"	Steps:	3" wide
Front Rails:	3-1/8" wide	Rear Rails:	1-3/4" wide
Front Flange:	1-3/16" wide	Rear Flange:	1-3/16" wide, 5/8" wide front

TW6200SERIES ††

300lbs. LOAD CAPACITY

TYPE IA
DUTY RATING

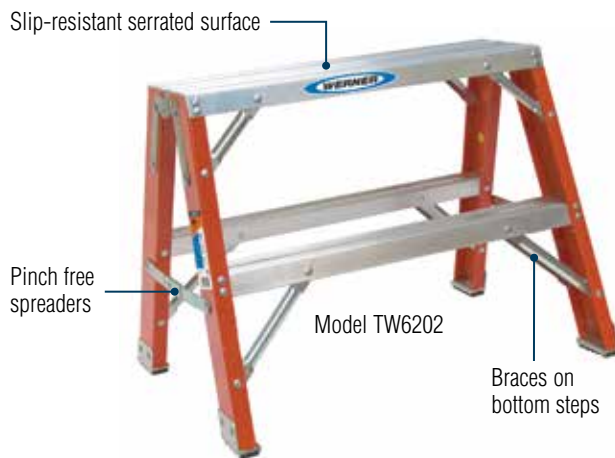

SPECIFICATIONS

Model No.	Size	Approx. Width	Approx. Spread	Approx. Cu. Ft. Per Unit	Approx. Shipping Wt. Lbs.
TW6202	2'	31-1/4"	22-1/4"	3.0	17.0
TW6203	3'	32-3/4"	29-3/4"	4.7	24.0

††Designed for one or two person jobs. Note: When used as a double stepladder, the maximum load per side, including person and materials, shall not exceed the duty rating of ladder.

DIMENSIONS

Top:	8" x 28"	Steps:	3" wide
Rails:	3-1/4" wide	Flange:	1-3/16" wide

T6202MODEL Twin Step Stool††

300lbs. LOAD CAPACITY PER SIDE

TYPE IA
DUTY RATING

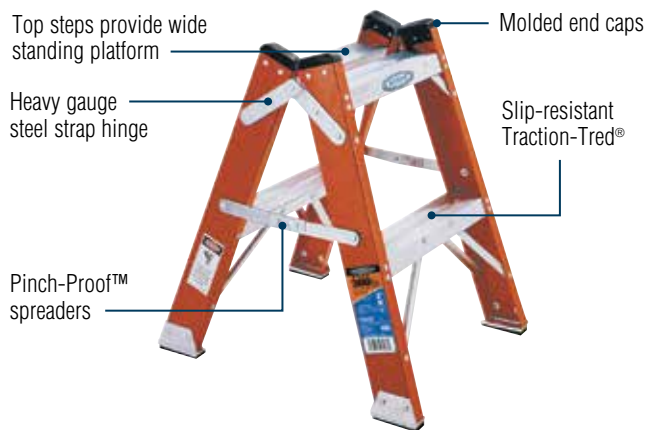

SPECIFICATIONS

Model No.	Size	Approx. Width	Approx. Spread	Approx. Cu. Ft. Per Unit	Approx. Shipping Wt. Lbs.
T6202	2'	21-1/8"	23"	2.1	11.5

††Designed for one or two person jobs. Note: When used as a double stepladder, the maximum load per side, including person and materials, shall not exceed the duty rating of ladder.

DIMENSIONS

Steps:	3" wide
Rails:	3-1/8" wide
Flange:	1-3/16" wide

Note: Planks or platforms shall be secured to the step stools. The ends of each plank or platform shall extend beyond the outside edge of each step stool by a minimum of 4 inches and a maximum of 10 inches.

SSFOOSERIES Step Stand

375lbs. LOAD CAPACITY

TYPE IAA
DUTY RATING

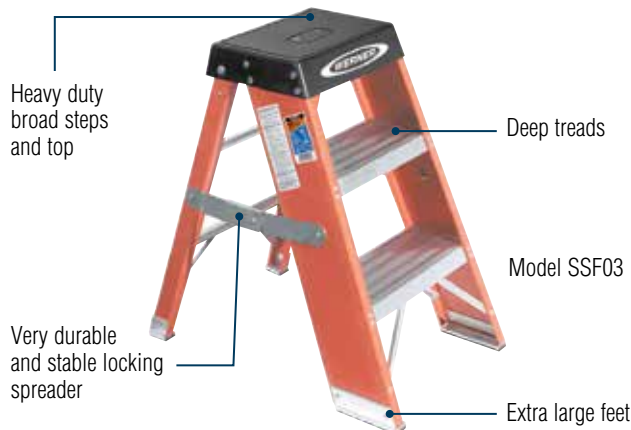

SPECIFICATIONS

Model No.	Size	Maximum Standing Height	Approx. Width	Approx. Spread	Approx. Cu. Ft. Per Unit	Approx. Shipping Wt. Lbs.
SSF02	2'	20"	17"	21"	2.6	15.0
SSF03	3'	30"	18-3/4"	27-1/2"	4.0	19.5

DIMENSIONS

Top:	9" x 14"	Steps:	6" wide
Front Rails:	6" wide	Rear Rails:	1-7/8" wide
Front Flange:	1-1/8" wide	Rear Flange:	1-3/16" wide

6100SERIES Stepladder

300lbs. LOAD CAPACITY

TYPE IA
DUTY RATING



COMPATIBLE
SEE PAGES 59-60

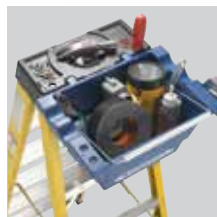
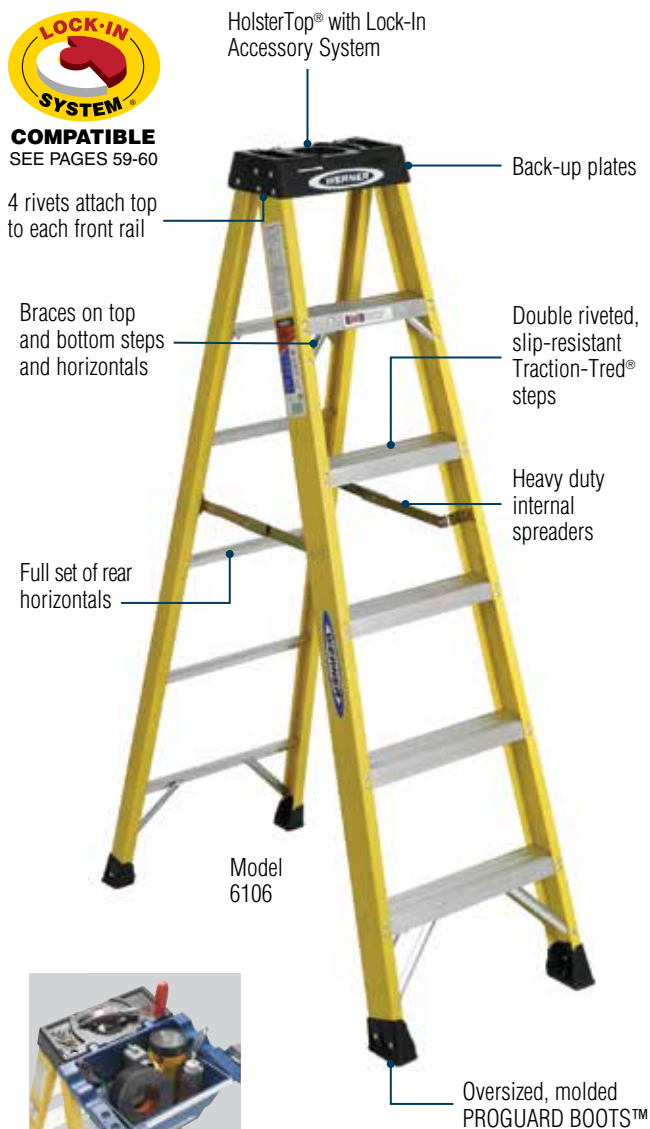

The Lock-In Accessory System lets you customize your ladder top and safely secure your tools.

SPECIFICATIONS

Model No.	Size	Approx. Width	Approx. Spread	Approx. Cu. Ft. Per Unit	Approx. Shipping Wt. Lbs.
6104	4'	19"	28-7/8"	2.6	15.0
6106	6'	22"	41-1/8"	4.5	21.0
6108	8'	25"	53-1/2"	6.8	30.0
6110	10'	28"	65-3/4"	13.0	35.5
6112	12'	31"	78-1/8"	17.3	44.0

DIMENSIONS

Top:	5-3/4" x 13"	Steps:	3" wide
Front Rails:	3-1/8" wide	Rear Rails:	1-7/8" wide
Flange:	1-3/16" wide		

6002MODEL Step Stool

250lbs. LOAD CAPACITY

TYPE I
DUTY RATING



©The blue and yellow ladder is an exclusive registered trademark of Werner Co.

SPECIFICATIONS

Model No.	Size	Approx. Width	Approx. Spread	Approx. Cu. Ft. Per Unit	Approx. Shipping Wt. Lbs.
6002	2'	17-1/4"	19-1/2"	1.4	8.5

DIMENSIONS

Top:	7" x 12-3/8"	Steps:	3" wide
Front Rails:	3-1/8" wide	Rear Rails:	1-3/4" wide
Front Flange:	1-1/8" wide	Rear Flange:	1-3/16" wide back 5/8" wide front

6000 & 6000S SERIES Stepladder

250lbs. LOAD CAPACITY

TYPE I
DUTY RATING



COMPATIBLE
SEE PAGES 59-60

HolsterTop® with Lock-In Accessory System now accommodates Impact Drivers

Sturdy paint can hanger on back side of top

Braces on top step, second step and top horizontal

External Pinch-Proof® spreaders

Slip-resistant Traction-Tred® steps

Model 6006

*Energy Diffusing Geometry
©The blue and yellow ladder is an exclusive registered trademark of Werner Co.

Foot pads riveted to the EDGE® structure



The Lock-In Accessory System lets you customize your ladder top and safely secure your tools.

EDGE® bracing provides enhanced strength and increased protection against damage

SPECIFICATIONS

Model No.	Size	Approx. Width	Approx. Spread	Approx. Cu. Ft. Per Unit	Approx. Shipping Wt. Lbs.	Model No. with Pail Shelf	Approx. Shipping Wt. Lbs.
6004	4'	19"	28-7/8"	2.6	13.0	6004S	15.0
6005	5'	20-1/2"	35"	3.5	16.0	6005S	18.0
6006	6'	22"	41-1/8"	4.5	18.0	6006S	20.0
6008	8'	25"	53-1/2"	6.8	25.5	6008S	27.5

DIMENSIONS

Top:	5-3/4" x 13"	Steps:	3" wide
Front Rails:	3-1/8" wide	Rear Rails:	1-3/4" wide
Front Flange:	1-1/8" wide	Rear Flange:	1-3/16" wide back 5/8" wide front

T6000 SERIES Multi-Use Twin Stepladder††

250lbs. LOAD CAPACITY PER SIDE

TYPE I
DUTY RATING

High performance dual HolsterTop®, paint and tool holder

Back-up aluminum plates

Braces on top steps and bottom three steps

Slip-resistant Traction-Tred® steps on front and rear sections

External Pinch-Proof® spreaders

Rubber step bumpers

EDGE®* molded brace and foot pad combination

Model T6008

* Energy Diffusing Geometry

- Every rivet backed up by metal plate or washer to protect rails
- © The blue and yellow ladder is an exclusive registered trademark of Werner Co.

SPECIFICATIONS

Model No.	Size	Approx. Width	Approx. Spread	Approx. Cu. Ft. Per Unit	Approx. Shipping Wt. Lbs.
T6004	4'	19"	36-1/8"	4.5	17.5
T6006	6'	22"	50-1/8"	7.9	24.5
T6008	8'	25"	64-1/8"	11.9	35.0

††Designed for one or two person jobs. Note: When used as a double stepladder, the maximum load per side, including person and materials, shall not exceed the duty rating of ladder.

DIMENSIONS

Top:	8-1/2" x 13"	Steps:	3" wide
Rails:	3-1/8" wide	Flange:	1-1/8" wide



PT6000/PT6000-4C SERIES Stocker's Ladder®††

250lbs. LOAD CAPACITY PER SIDE

TYPE I
DUTY RATING

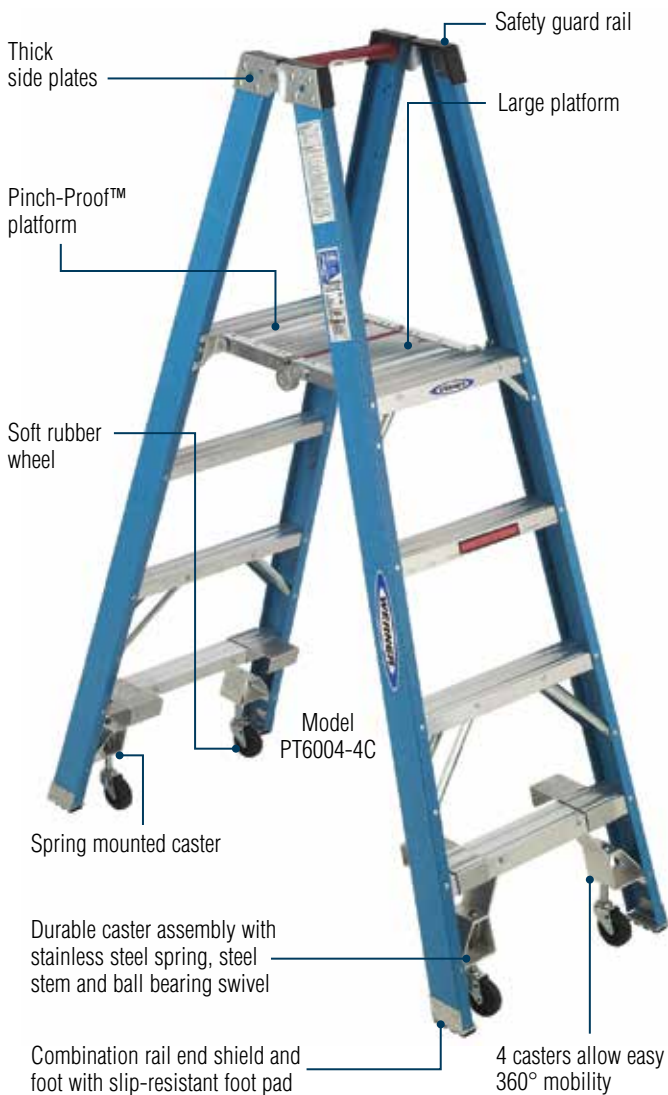

- Easy to handle and folds to a 12" width for storage
- Unique combination of one person, platform ladder or two person use††
- External Pinch-Proof™ spreaders on 8' model
- Requires less floor space than heavy steel rolling ladders

SPECIFICATIONS

Model No.	Height (Size) to Platform	Rail Length	Approx. Width	Approx. Spread	Approx. Cu. Ft. Per Unit	Approx. Shipping Wt. Lbs.	Model No. with Casters	Approx. Shipping Wt. Lbs.
PT6002	2'	4'	20"	36-1/2"	6.4	21.0	PT6002-4C	27.0
PT6003	3'	5'	22"	44"	8.5	24.5	PT6003-4C	31.0
PT6004	4'	6'	23"	51"	11.1	28.0	PT6004-4C	35.0
PT6006	6'	8'	26"	65-1/2"	16.7	39.0	PT6006-4C	47.0
PT6008	8'	10'	29"	80"	23.4	52.0	PT6008-4C	64.5

†† Designed for one or two person jobs. Note: When used as a double stepladder, the maximum load per side, including person and materials, shall not exceed the duty rating of ladder.

DIMENSIONS

Platform:	12-3/4" x 22"	Steps:	3" wide
Rails:	3-1/8" wide	Flange:	1-1/8" wide

5900 & 5900S SERIES Stepladder

225lbs. LOAD CAPACITY

TYPE II
DUTY RATING



- * Energy Diffusing Geometry
- Optional yellow molded pail shelf kit, model no. 76-9 or PK76-9 available for 5900 series

SPECIFICATIONS

Model No.	Size	Approx. Width	Approx. Spread	Approx. Cu. Ft. Per Unit	Approx. Shipping Wt. Lbs.	Model No. with Pail Shelf	Approx. Shipping Wt. Lbs.
5904	4'	19"	28-7/8"	2.6	11.5	N/A	N/A
5906	6'	22"	41-1/8"	4.5	16.0	5906S	16.5
5908	8'	25"	53-1/2"	6.8	22.5	5908S	23.0

DIMENSIONS

Top:	5-3/8" x 13"	Steps:	3" wide
Front Rails:	3-1/8" wide	Rear Rails:	1-3/4" wide
Front Flange:	1-1/8" wide	Rear Flange:	1-3/16" wide

FIBERGLASS STEPLADDER COMPARISON CHART



Features and Benefits	7400 SERIES	T7400 SERIES	P7400 SERIES	7300 SERIES	6200 SERIES	T6200 SERIES	P6200 SERIES	6100 SERIES	6000 SERIES	T6000 SERIES	5900 SERIES
	TYPE IAA	TYPE IAA/IA	TYPE IAA/IA	TYPE IAA	TYPE IA	TYPE IA	TYPE IA	TYPE IA	TYPE I	TYPE I	TYPE II
Slip-resistant Traction-Tred® steps	●	●	●	●	●	●	●	●	●	●	●
Slip-resistant foot pad	●	●	●	●	●	●	●	●	●	●	●
LOCKTOP™					●	●					
Aluminum drill HolsterTop®	●			●							
HolsterTop®								●	●	●	●
Aluminum top		●									
Lock-In Accessory System					●			●	●		●
Designed for one or two person jobs		●								●	
Slip-resistant Traction-Tred® steps all knee braced	●	●	●	●	●	●	●				
Molded braces	●	●	●	●	●	●	●		●	●	●
Rail shields	●	●	●	●	●	●	●				
Oversized Foot Pads				●	●	●	●				
Internal spreaders	●	●		●	●	●		●			
External spreaders									●	●	●
Full set of rear horizontals	●		●	●	●		●	●			
Platform for comfortable work area			●				●				
Shoulder bolt and nut on top hinge	●	●	●	●		●	●			●	
Back-up plates to reinforce top connectors	●	●	●	●	●	●	●	●	●	●	●
Every rivet backed up by metal plate or washer to protect fiberglass	●	●	●	●	●	●	●	●	●	●	●
4 rivets attach top to each front rail	●	●	●	●	●	●	●	●			



PODIUM & PODIUM GATE

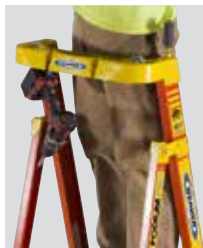

Extended guard rail securely wraps around work zone and holds an arsenal of tools



Extra-large standing platform for long standing comfort



Folds up for storage



Fully surrounds the user



Latch keeps the user inside the ladder footprint

Work facing any direction

- **4X WORK ZONE**

Allows you to work facing any direction so you can accomplish more without having to reposition your ladder.

- Ideal for working at fixed heights and easier to maneuver than scaffolds or lifts.
- Feel like you're standing on the ground with the extra-large platform, 36" high extended guard rail and LOCKTOP™ wrap around ladder top.
- Available in Type IAA (375lb capacity) and Type IA (300lb capacity) Duty Ratings
- Available with factory-installed casters for improved mobility
- For working around electricity. Non-conductive side rails.

Attaches to any Werner Podium

- Easily retrofitted; convenient and affordable
- Fully surrounds the user
- Helps keep the ladder user inside the ladder footprint
- Work facing any direction
- Neatly collapses for easy access and storage

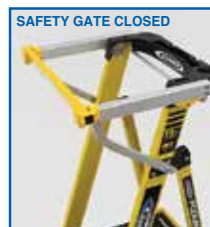

SPECIFICATIONS

Model No.	Fits On	Approx. Shipping Dimensions	Approx. Shipping Wt. Lbs
AC63	All Podium Ladders	4.8" x 28" x 4.2"	6

* Ladder sold separately

PD7300/PD7300-4CSERIES Podium Ladder

375lbs. LOAD CAPACITY

TYPE IAA
DUTY RATING

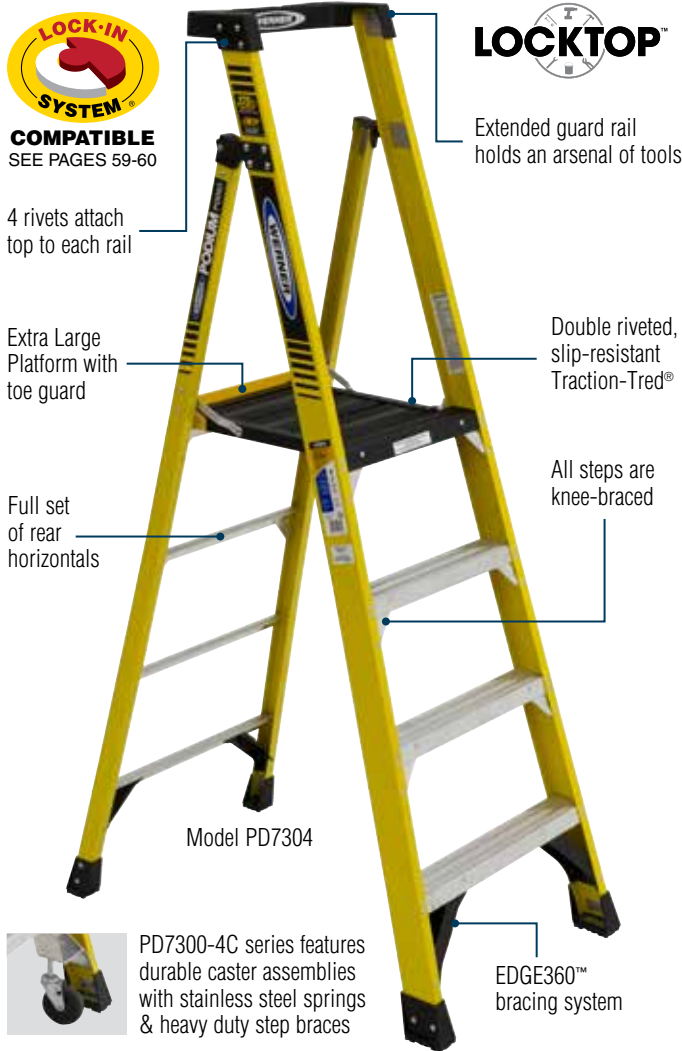

- Ideal for working at fixed heights, easier to maneuver than scaffolds or lifts
- Customize your ladder top with the Lock-In Accessory System
- EDGE360™ features Intergrated Rail Shields, Energy Diffusing Geometry, and Oversized Foot Pads
- Every rivet backed up by metal plate or washer to protect rails
- Internal aluminum spreaders on 6' and 8' models

SPECIFICATIONS

Model No.	Height (Size) to Platform	Max. Reach	Approx. Width	Approx. Spread	Approx. Cu. Ft. Per Unit	Approx. Shipping Wt. Lbs.	Model No. with Casters	Approx. Shipping Wt. Lbs.
PD7302	2'	8'	24"	31"	7.0	20.0	PD7302-4C	28.0
PD7303	3'	9'	26"	37"	9.2	21.0	PD7303-4C	28.3
PD7304	4'	10'	27-1/2"	43"	11.3	26.5	PD7304-4C	33.8
PD7305	5'	11'	29-1/4"	50"	13.8	32.5	PD7305-4C	41.0
PD7306	6'	12'	31"	56"	16.4	38.5	PD7306-4C	45.8
PD7307	7'	13'	33"	62"	19.4	38.0	PD7307-4C	47.0
PD7308	8'	14'	34-1/2"	68"	22.3	45.5	PD7308-4C	52.8
PD7312	12'	18'	41-1/2"	93"	36.8	66.5	PD7312-4C	74.5

DIMENSIONS

Platform:	16" x 19.5"	Steps:	3" wide
Front Rails:	3-1/8" wide	Rear Rails:	1-7/8" wide
Front Flange:	1-3/16" wide	Rear Flange:	1-3/16" wide

PD6200/PD6200-4CSERIES Podium Ladder

300lbs. LOAD CAPACITY

TYPE IA
DUTY RATING

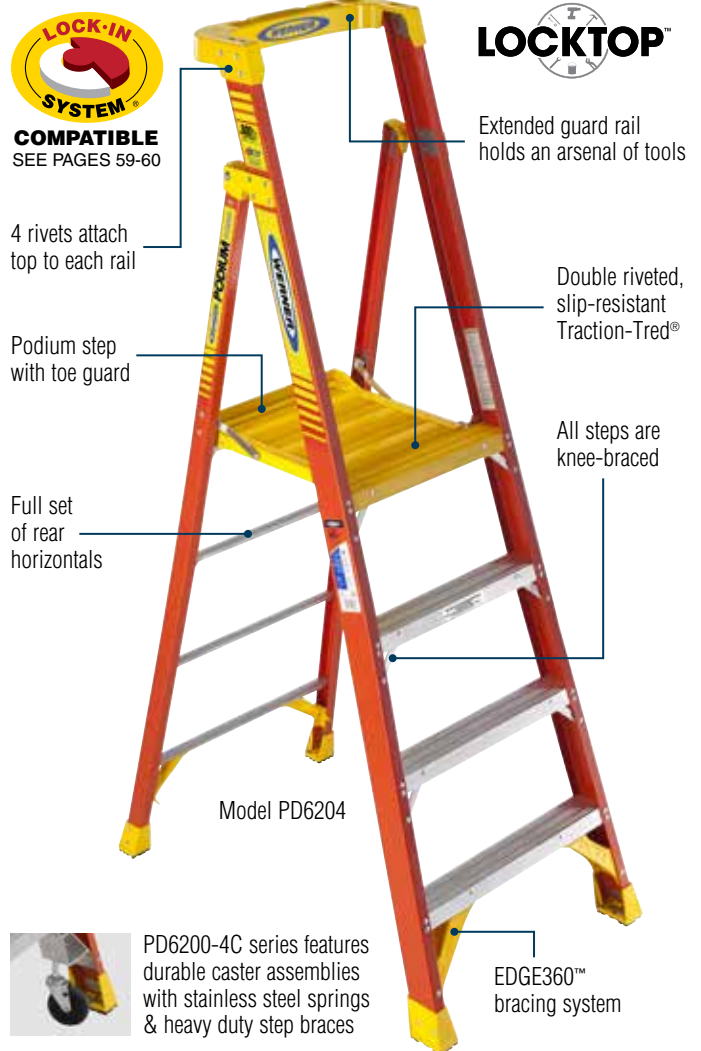

- Ideal for working at fixed heights, easier to maneuver than scaffolds or lifts
- Customize your ladder top with the Lock-In Accessory System
- EDGE360™ features Intergrated Rail Shields, Energy Diffusing Geometry, and Oversized Foot Pads
- Every rivet backed up by metal plate or washer to protect rails
- Internal aluminum spreaders on 8' and 10' models

SPECIFICATIONS

Model No.	Height (Size) to Platform	Max. Reach	Approx. Width	Approx. Spread	Approx. Cu. Ft. Per Unit	Approx. Shipping Wt. Lbs.	Model No. with Casters	Approx. Shipping Wt. Lbs.
PD6202	2'	8'	24"	31"	7.0	20.0	PD6202-4C	28.0
PD6203	3'	9'	26"	37"	9.2	21.0	PD6203-4C	28.3
PD6204	4'	10'	27-1/2"	43"	11.3	26.5	PD6204-4C	33.8
PD6205	5'	11'	29-1/4"	50"	13.8	32.5	PD6205-4C	41.0
PD6206	6'	12'	31"	56"	16.4	34.5	PD6206-4C	42.5
PD6207	7'	13'	33"	62"	19.4	38.0	PD6207-4C	47.0
PD6208	8'	14'	34-1/2"	68"	22.3	44.5	PD6208-4C	51.8
PD6210	10'	16'	38"	80"	29.1	55.5	PD6210-4C	62.8
PD6212	12'	18'	41-1/2"	93"	36.8	66.5	PD6212-4C	74.5

DIMENSIONS

Platform:	16" x 19.5"	Steps:	3" wide
Front Rails:	3-1/8" wide	Rear Rails:	1-7/8" wide
Front Flange:	1-3/16" wide	Rear Flange:	1-3/16" wide



Multi-Position Fiberglass Pro

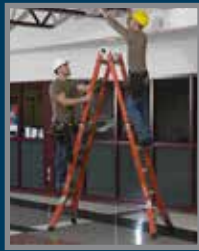

300lb load capacity per side



**Scaffolding bases require no additional hinges*
*plank and tie-downs not included**

FIVE LADDERS IN ONE

Extension ladder



Wall ladder



Twin stepladder



Stairway stepladder



2-scaffold bases*



FMTSERIES Multi-Position Ladder

300lbs. LOAD CAPACITY

TYPE IA
DUTY RATING

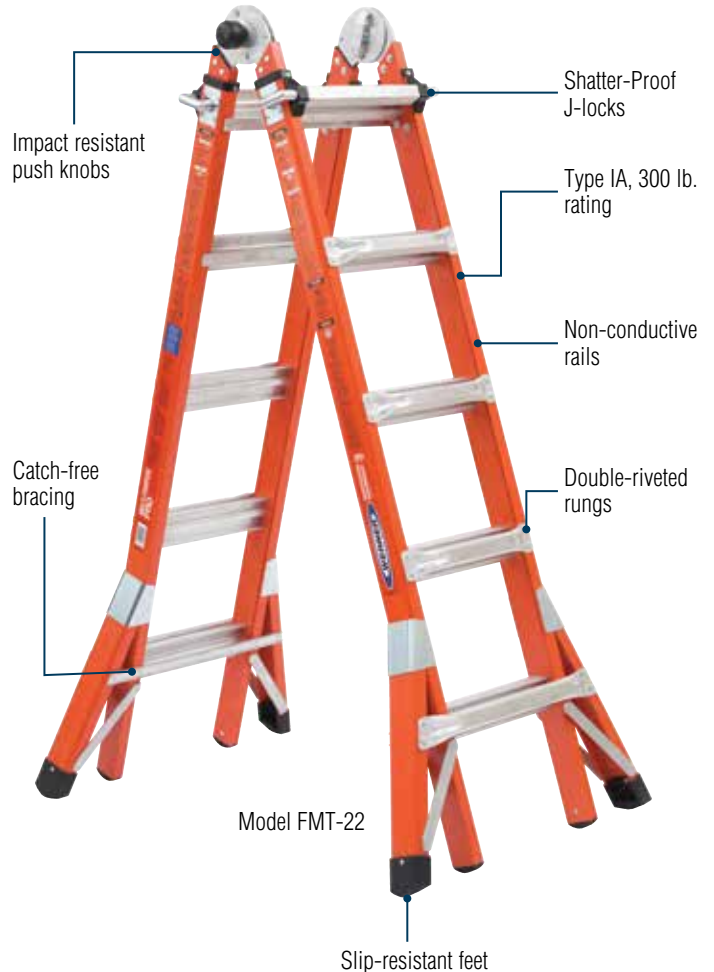

- Non-conductive side rails
- Impact resistant push knobs
- Shatter-Proof J-locks
- Type IA, 300 lb. rating
- Double riveted rungs
- Catch-free bracing
- Slip resistant feet

SPECIFICATIONS

Model No.	Stepladder Height (ft)	Stairway Height (ft)	Wall Height (ft)	Extension Height (ft)	Scaffold Height (ft)	Weight (lbs)
FMT-13	3 to 5	3 to 5	3 to 5	7 to 11	1 to 2	33.2
FMT-17	4 to 7	4 to 7	4 to 7	9 to 15	1 to 3	39.9
FMT-22	5 to 9	5 to 9	5 to 9	11 to 19	1 to 4	49.9

DIMENSIONS

Rails:	2-5/8"	Rung:	1-1/8"
Flange:	1"	Steps/Rung:	1"

Dual Purpose 2-IN-1 Ladder



Oversized PROGUARD BOOTS for added rail protection



Convenient to store and maneuver



Comfortable double width standing platform

DP6200 SERIES Dual-Purpose Ladder

300lbs. LOAD CAPACITY

TYPE IA
DUTY RATING

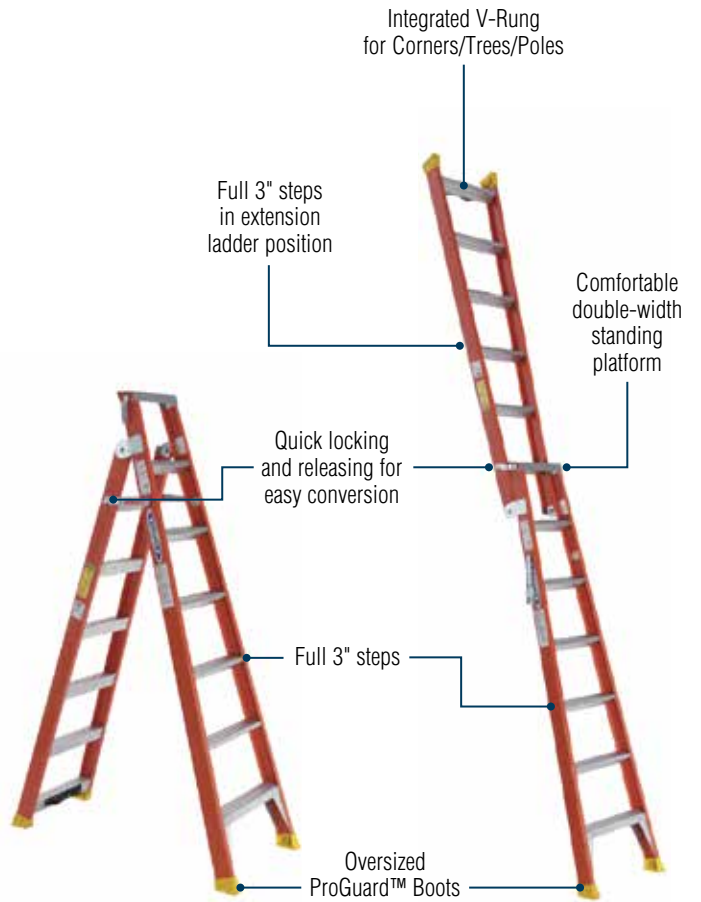

FLIP & CLICK

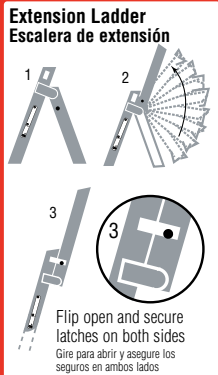

WERNER DUAL PURPOSE

- One ladder to carry on the job
- Easy to use: Flip & Click to extension ladder position
- Easy to transport on compact vehicles
- Stepladder standing comfort on an extension ladder (3 steps)
- V-Rung for use on poles, trees and corners

Ideal for electricians, HVAC and independent contractors

SPECIFICATIONS

Model No.	Stepladder Size	Stepladder Max. Reach Height	Extension Ladder Size	Extension Max. Reach Height	Approx. Weight
DP6206	6'	10'	10'	13'	25.4 lbs.
DP6207	7'	11'	12'	15'	29.4 lbs.
DP6208	8'	12'	14'	17'	33.8 lbs.

DIMENSIONS

Top:	5-3/4" x 13"	Platform:	16" x 6" (extension position)
Front Rails:	3-1/8" wide	Rear Rails:	3-1/8" wide
Front Flange:	1-3/16" wide	Rear Flange:	1-3/16" wide





D7100-2LV SERIES D-Rung Extension Ladder w/Integrated Leveling

375lbs. LOAD CAPACITY

TYPE IAA
DUTY RATING

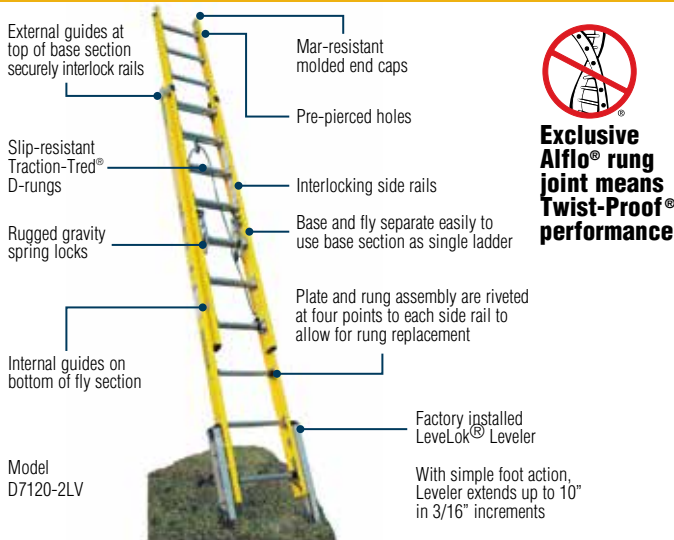

SPECIFICATIONS NOTE: Type IAA duty rating is for extension ladders up to 32 feet

Model No.	Total Length of Sections	Max. Working Length	Approx. Cu. Ft. Per Unit	Approx. Shipping Wt. Lbs.
D7120-2LV	20'	17'	8.6	58.0
D7124-2LV	24'	21'	10.3	66.5
D7128-2LV	28'	25'	12.0	75.0
D7132-2LV	32'	29'	13.7	90.5

300lbs. LOAD CAPACITY

TYPE IA
DUTY RATING

D7136-2LV	36'	32'	20.2	121.0
D7140-2LV	40'	35'	22.5	134.5

DIMENSIONS

Rails:	Flange:	Rungs:	Fly Width:	Base Width:
20' to 32'	3-5/16"	1-3/16"	1-5/8"	16-1/8" outside rails, 19" outside rails, 22-3/4" outside shoes
36' & 40'	4"	1-3/4"	1-3/4"	16-3/4" outside rails, 22" outside rails, 25-3/4" outside shoes

D7100-2SERIES D-Rung Extension Ladder

375lbs. LOAD CAPACITY

TYPE IAA
DUTY RATING

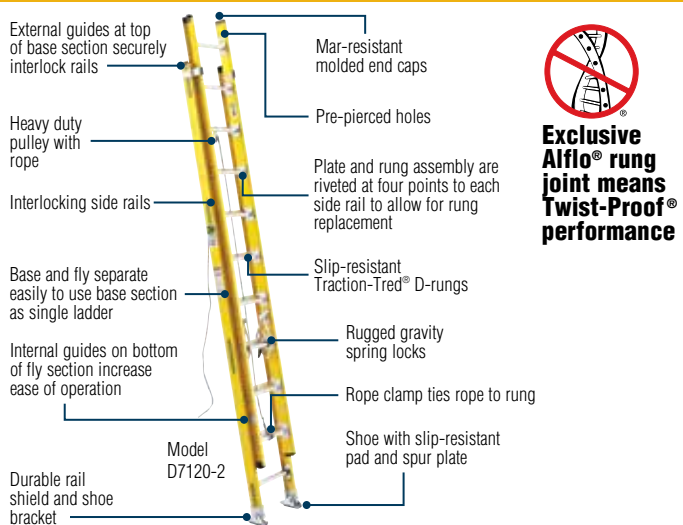

SPECIFICATIONS NOTE: Type IAA duty rating is for extension ladders up to 32 feet

Model No.	Total Length of Sections	Max. Working Length	Approx. Cu. Ft. Per Unit	Approx. Shipping Wt. Lbs.
D7116-2‡	16'	13'	7.0	41.0
D7120-2	20'	17'	8.7	50.0
D7124-2	24'	21'	10.3	58.5
D7128-2	28'	25'	12.0	67.0
D7132-2	32'	29'	13.7	82.5

300lbs. LOAD CAPACITY

TYPE IA
DUTY RATING

D7136-2	36'	32'	23.8	113.0
D7140-2	40'	35'	26.7	126.5

‡ Note: D7116-2 is not equipped with rope and pulley

DIMENSIONS

Rails:	Flange:	Rungs:	Fly Width:	Base Width:
16' to 32'	3-5/16"	1-3/16"	1-5/8"	16-1/8" outside rails, 19" outside shoes
36' and 40'	4"	1-3/4"	1-3/4"	16-3/4" outside rails, 22" outside shoes

D7100-2GHV SERIES Fiberglass High Visibility Extension Ladder

375lbs. LOAD CAPACITY

TYPE IAA
DUTY RATING

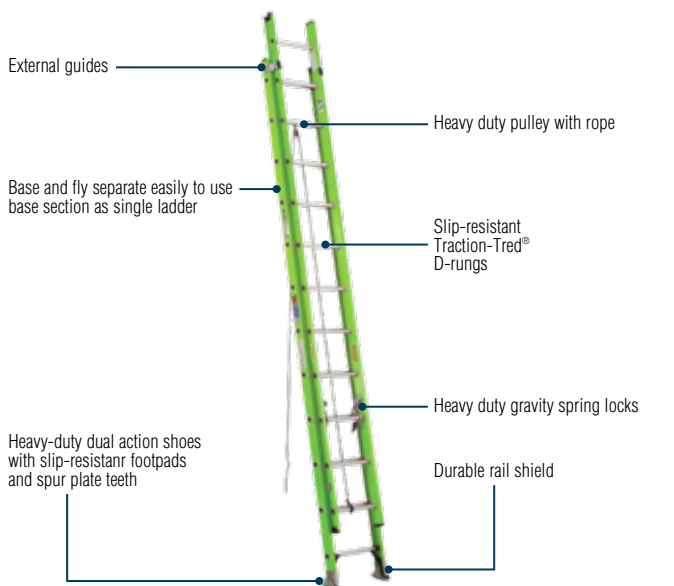

SPECIFICATIONS NOTE: Type IAA duty rating is for extension ladders up to 32 feet

Model No.	Total Length of Sections	Max. Working Length	Approx. Shipping Wt. Lbs.
D7116-2GHV	16'	13'	36.0
D7120-2GHV	20'	17'	44.0
D7124-2GHV	24'	21'	51.0
D7128-2GHV	28'	25'	58.0

DIMENSIONS

Rails:	Flange:	Rungs:	Fly Width:	Base Width:
16' to 28'	3-5/16"	1-3/16"	1-5/8"	16-1/8" outside rails, 19" outside rails, 22-3/4" outside shoes

7100-2/7100-1SERIES Round Rung Extension/Straight Ladder

375lbs. LOAD CAPACITY

TYPE IAA
DUTY RATING



Exclusive Alflo® rung joint means Twist-Proof® performance

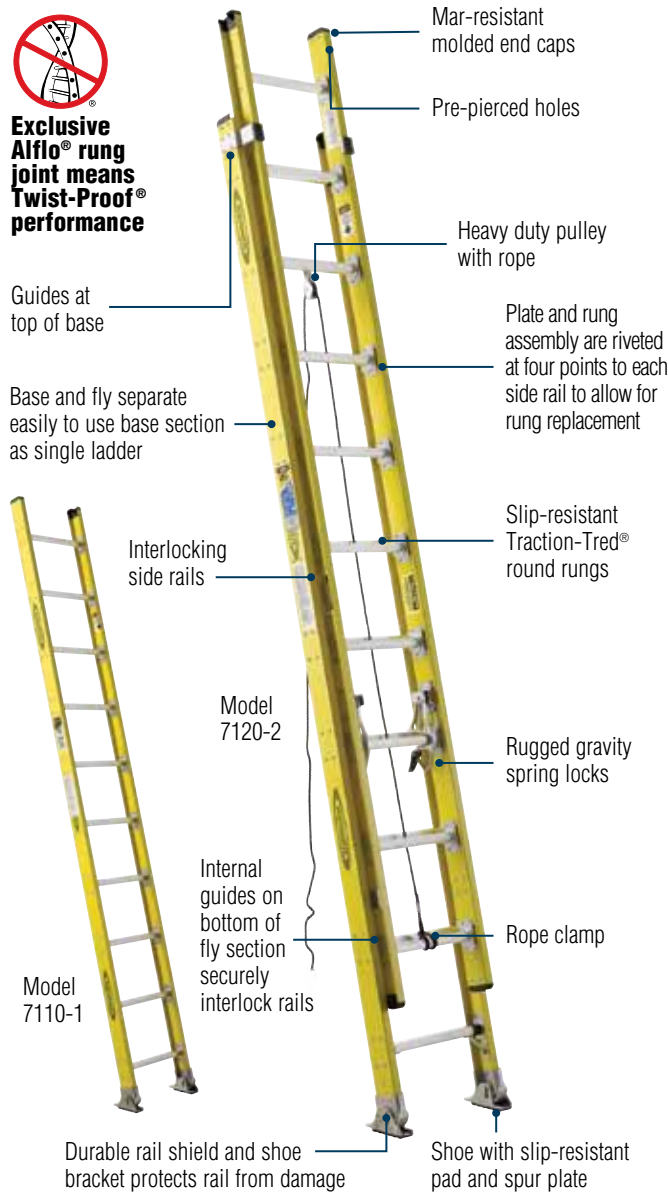

SPECIFICATIONS

Model No.	Total Length of Sections	Max. Working Length	Approx. Cu. Ft. Per Unit	Approx. Shipping Wt. Lbs.	Straight Ladder Model No.	Total Length	Approx. Cu. Ft. Per Unit	Approx. Shipping Wt. Lbs.
7116-2‡	16'	13'	7.0	38.5	7108-1	8'	4.5	20.0
7120-2	20'	17'	8.7	47.0	7110-1	10'	5.5	24.0
7124-2	24'	21'	10.3	55.0	7112-1	12'	6.5	28.0
7128-2	28'	25'	12.0	63.0	7114-1	14'	7.6	32.0
7132-2	32'	29'	13.7	78.0	7116-1	16'	8.6	40.0

300lbs. LOAD CAPACITY

TYPE IA
DUTY RATING

—	—	—	—	—	7118-1	18'	12.5	52.0
—	—	—	—	—	7120-1	20'	13.9	58.0

‡ Note: 7116-2 is not equipped with rope and pulley

DIMENSIONS

	Rails:	Flange:	Rungs:	Width (outside rails):	Width (outside shoes):
7100-2: ALL					
7100-1: 8' to 16'	3-5/16"	1-3/16"	1-1/4"	17-3/4" outside rails	19" outside shoes
7118-1, 7120-1	4"	1-3/4"	1-1/4"	16-13/16" outside rails	18-1/16" outside shoes

D8200-2EQSERIES Extension Ladder w/Integrated Leveling

300lbs. LOAD CAPACITY

TYPE IA
DUTY RATING



Exclusive Alflo® rung joint means Twist-Proof® performance

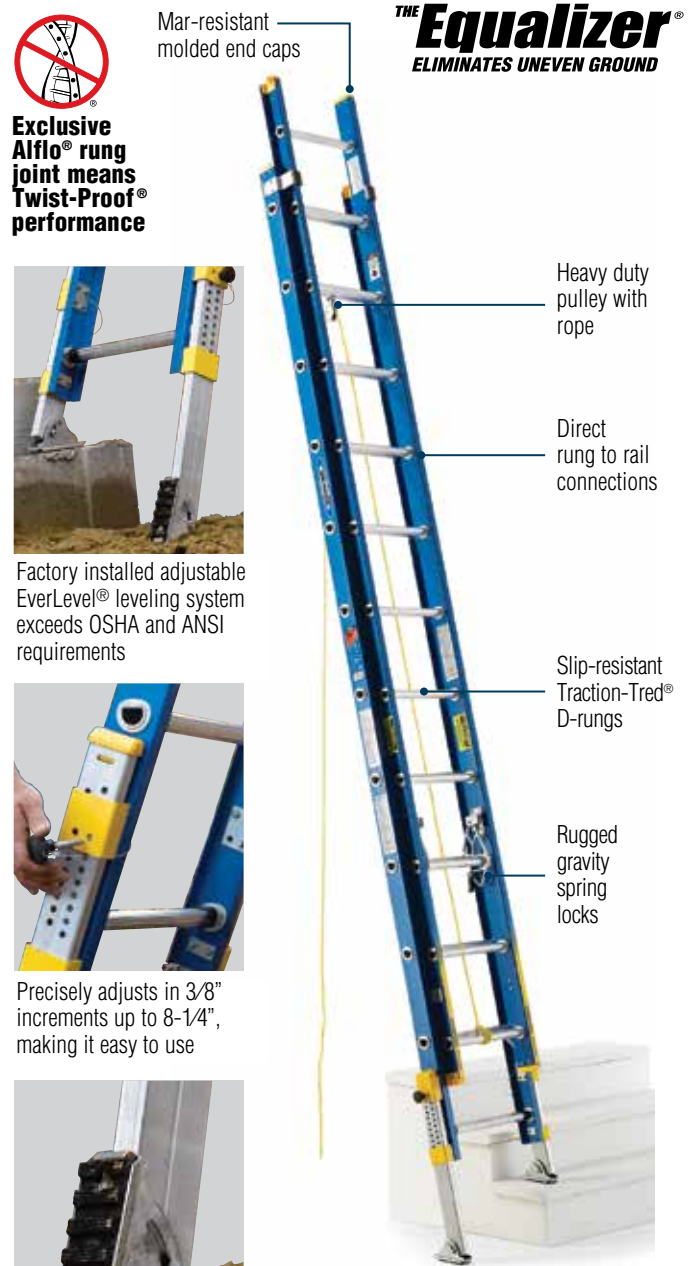

THE Equalizer®
ELIMINATES UNEVEN GROUND

Factory installed adjustable EverLevel® leveling system exceeds OSHA and ANSI requirements

Precisely adjusts in 3/8" increments up to 8-1/4", making it easy to use



Dual action feet for use on hard or penetrable surfaces

SPECIFICATIONS

Model No.	Total Length of Sections	Max. Working Length	Approx. Cu. Ft. Per Unit	Approx. Shipping Wt. Lbs.
D8220-2EQ	20'	17'	10.0	54.0
D8224-2EQ	24'	21'	11.9	62.0
D8228-2EQ	28'	25'	13.8	70.0

DIMENSIONS

Rails:	3-5/16" wide	Fly Width:	16" outside rails
Flange:	1-3/16" wide	Base Width:	17-3/4" outside rails, 21-7/16" outside of feet
Rungs:	1-5/8"		

®The blue and yellow ladder is an exclusive registered trademark of Werner Co.





D6200-2/D6200-ISERIES D-Rung Extension/Straight Ladder

300lbs. LOAD CAPACITY

TYPE IA
DUTY RATING

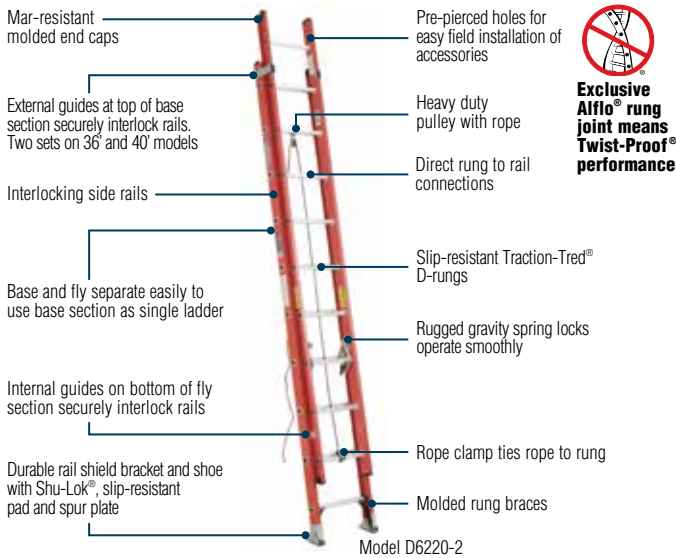

SPECIFICATIONS

Model No.	Total Length of Sections	Max. Working Length	Approx. Working Cu. Ft. Per Unit	Approx. Shipping Wt. Lbs.	Single Ladder Model No.	Total Length	Approx. Working Cu. Ft. Per Unit	Approx. Shipping Wt. Lbs.
D6216-2‡	16'	13'	7.0	36.5	D6208-1	8'	4.7	19.5
D6220-2	20'	17'	8.7	44.5	D6210-1	10'	5.8	23.0
D6224-2	24'	21'	10.3	52.0	D6212-1	12'	6.9	27.0
D6228-2	28'	25'	12.0	59.5	D6214-1	14'	8.0	31.0
D6232-2	32'	29'	13.7	71.5	D6216-1	16'	9.1	37.0
D6236-2	36'	32'	15.3	80.5	--	--	--	--
D6240-2	40'	35'	17.0	88.5	D6220-1	20'	11.5	45.5

‡ Note: D6216-2 is not equipped with rope and pulley

DIMENSIONS

Rails:	3-5/16" wide	Fly Width:	16" outside rails
Flange:	1-3/16" wide	Base Width:	19" outside shoes
Rungs:	1-5/8"		

D6200-3SERIES D-Rung Compact Extension Ladder

300lbs. LOAD CAPACITY

TYPE IA
DUTY RATING

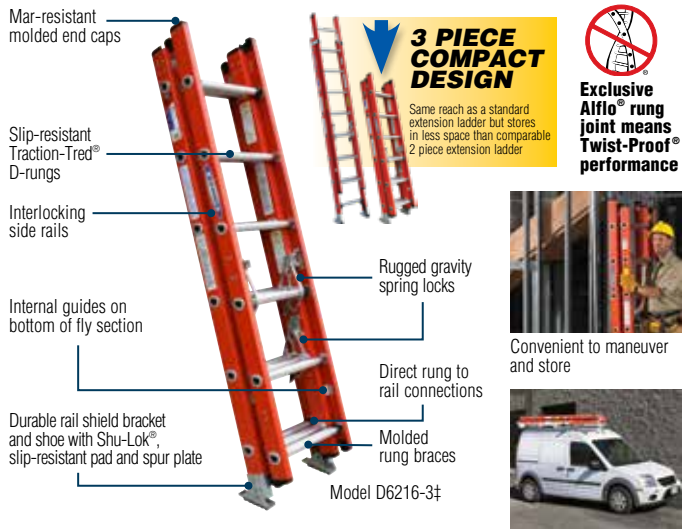

‡ Note: D6216-3 is not equipped with rope and pulley

SPECIFICATIONS

Model No.	Total Length of Sections	Total Length in Storage Position 2 vs. 3 piece*	Max. Working Length	Approx. Working Cu. Ft. Per Unit	Approx. Shipping Wt. Lbs.
D6216-3	18'	8' / 6'	13'	8.5	40.5
D6220-3	23'	10' / 8'	17'	11.1	54.0
D6224-3	27'	12' / 9'	21'	12.4	61.0
D6228-3	31'	14' / 11'	26'	15.0	74.5
D6232-3	35'	16' / 12'	29'	13.7	81.0

* Total Length of ladder in storage position, comparison of Standard 2 - piece vs. New 3 - piece extension ladder.

DIMENSIONS

Rails:	3-5/16" wide	Fly Width:	16" outside rails
Flange:	1-3/16" wide	Base Width:	19" outside shoes
Rungs:	1-5/8"		



D6200-2GHSV SERIES Fiberglass High Visibility Extension Ladder

300lbs. LOAD CAPACITY

TYPE IA
DUTY RATING

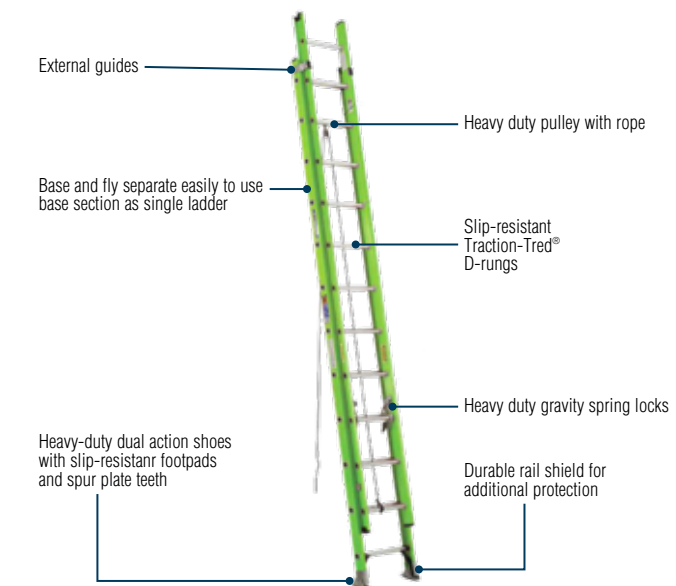

SPECIFICATIONS

Model No.	Total Length of Sections	Max. Working Length	Approx. Shipping Wt. Lbs.
D6216-2GHV	16'	13'	32.0
D6220-2GHV	20'	17'	40.0
D6224-2GHV	24'	21'	46.0
D6228-2GHV	28'	25'	53.0

DIMENSIONS

Rails:	Flange:	Rungs:	Fly Width:	Base Width:
16' to 28'	3-5/16"	1-3/16"	1-5/8"	16-1/8" outside rails, 19" outside rails, 22-3/4" outside shoes

D6000-2SERIES D-Rung Extension Ladder

250lbs. LOAD CAPACITY

TYPE I
DUTY RATING

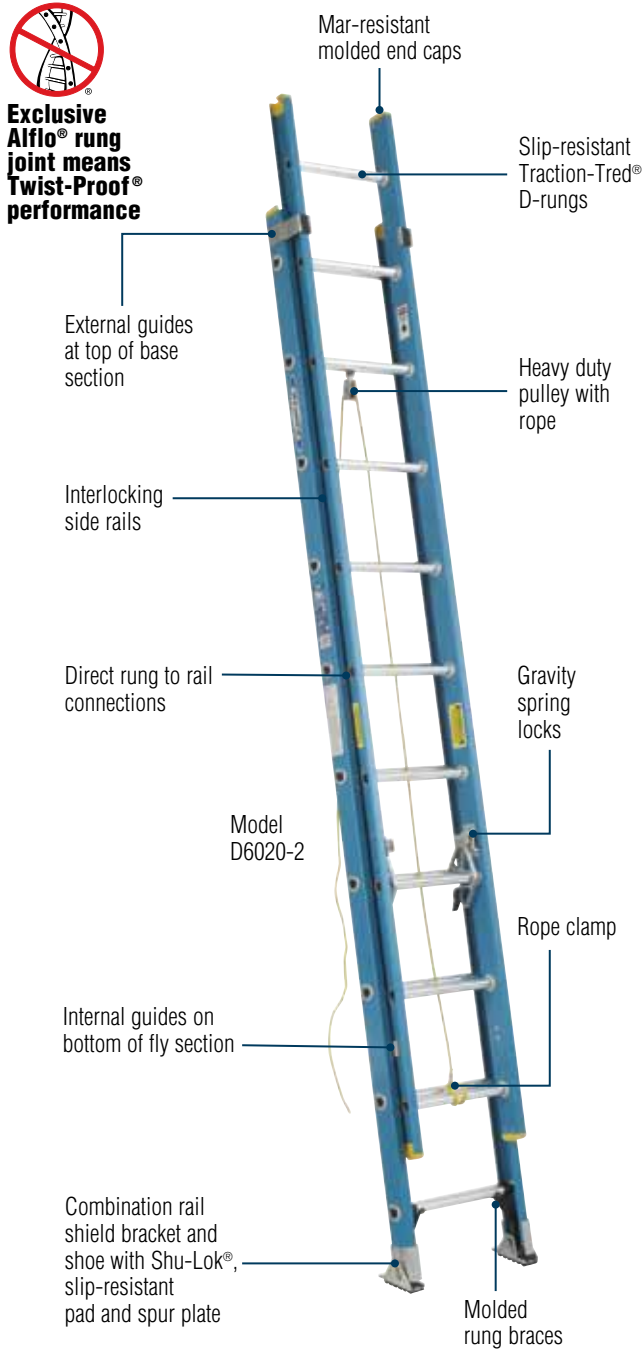

D5900-2SERIES D-Rung Extension Ladder

225lbs. LOAD CAPACITY

TYPE II
DUTY RATING

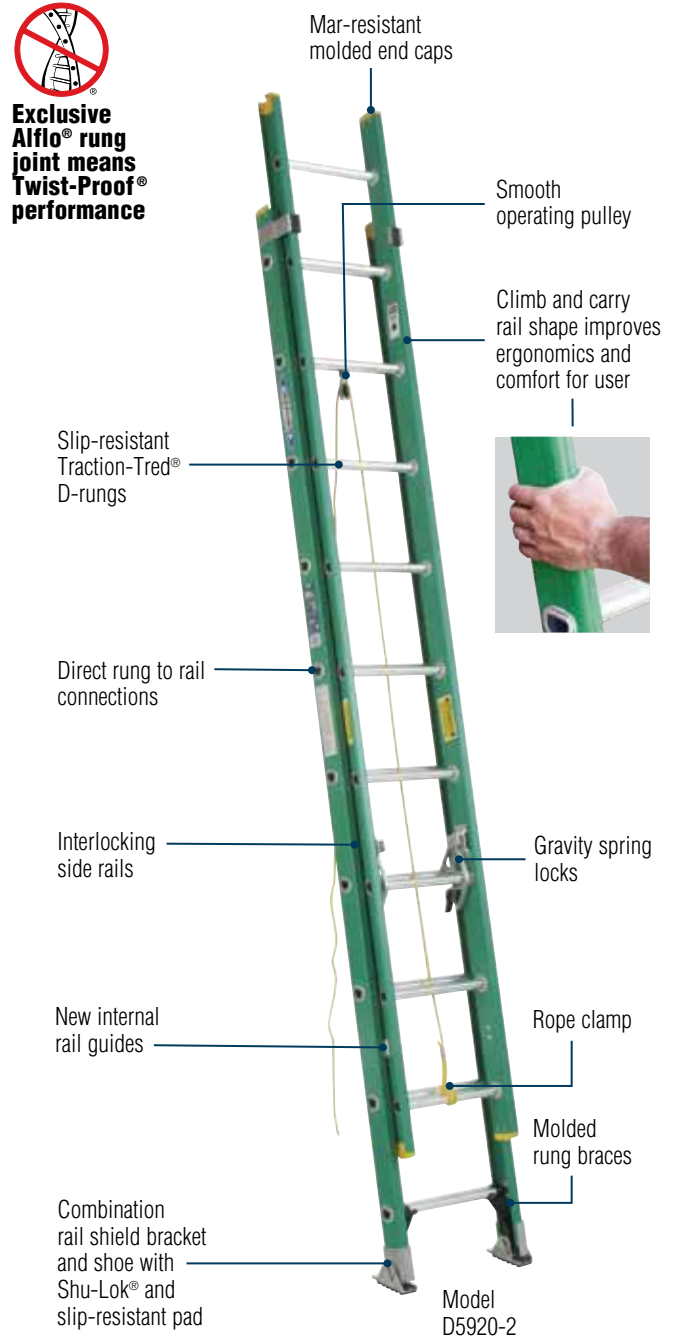

©The blue and yellow ladder is an exclusive registered trademark of Werner Co.

SPECIFICATIONS

Model No.	Total Length of Sections	Max. Working Length	Approx. Cu. Ft. Per Unit	Approx. Shipping Wt. Lbs.
D6016-2‡	16'	13'	7.0	32.5
D6020-2	20'	17'	8.7	39.0
D6024-2	24'	21'	10.3	46.0
D6028-2	28'	25'	12.0	55.5

‡ Note: D6016-2 is not equipped with rope and pulley

DIMENSIONS

Rails:	3-3/8" wide	Fly Width:	15-3/4" outside rails
Flange:	1-3/16" wide	Base Width:	18-1/8" outside shoes
Rungs:	1-1/2"		

SPECIFICATIONS

Model No.	Total Length of Sections	Max. Working Length	Approx. Cu. Ft. Per Unit	Approx. Shipping Wt. Lbs.
D5916-2‡	16'	13'	5.9	27.0
D5920-2	20'	17'	7.4	33.0
D5924-2	24'	21'	8.9	39.0

‡ Note: D5916-2 is not equipped with rope and pulley

















DIMENSIONS

Rails:	3-5/16" wide	Fly Width:	15-1/8" outside rails
Flange:	1-3/16" wide	Base Width:	17-3/4" outside shoes
Rungs:	1-1/2"		





FIBERGLASS EXTENSION LADDER COMPARISON CHART

Features and Benefits	D7200-2 SERIES	D7100-2LV SERIES	D7100-2 SERIES	7100 SERIES	D8200-2EQ SERIES	D6400-2 SERIES	D6200 SERIES	D6000-2 SERIES	D5900-2 SERIES
	TYPE IAA/IA	TYPE IAA/IA	TYPE IAA/IA	TYPE IAA	TYPE IA	TYPE IA	TYPE IA	TYPE I	TYPE II
 Guides at top of base section	●	●	●	●	●	●	●	●	
 Guides on bottom of fly section	●	●	●	●	●	●	●	●	●
 Pulley and rope systems	●	●	●	●	●	●	●	●	●
 Rail shield and shoe bracket protects rail	●	●	●	●	●	●	●	●	
 Shoe with slip-resistant pad and spur plate	●	●	●	●	●	●	●	●	●
 Rugged gravity spring locks	●	●	●	●	●	●	●	●	●
 Rope clamp ties rope to rung	●	●	●	●	●	●	●	●	●
 Alflo® rung joint for Twist-Proof® performance	●	●	●	●	●	●	●	●	●
Electrically non-conductive side rails	●	●	●	●	●	●	●	●	●
 Mar-resistant molded end caps	●	●	●	●	●	●	●	●	●
Base section may be used as a single ladder	●	●	●	●	●	●	●	●	●
 Pre-pierced holes for easy field installation of accessories	●	●	●	●	●	●	●		
 Plate and rung assembly to allow for rung replacement	●	●	●	●					
 Direct rung to rail connections					●	●	●	●	●
 Interlocking side rails	●	●	●	●	●	●	●	●	●
 Slip-resistant D-rungs	●	●	●		●	●	●	●	●
 Slip-resistant round rungs				●					
 Molded rung braces						●	●	●	●
 Integrated leveling		●			●				

7800SERIES Combination Step/Extension Ladder††

375lbs. LOAD CAPACITY

TYPE IAA
DUTY RATING



Exclusive Alflo® rung joint means Twist-Proof® performance

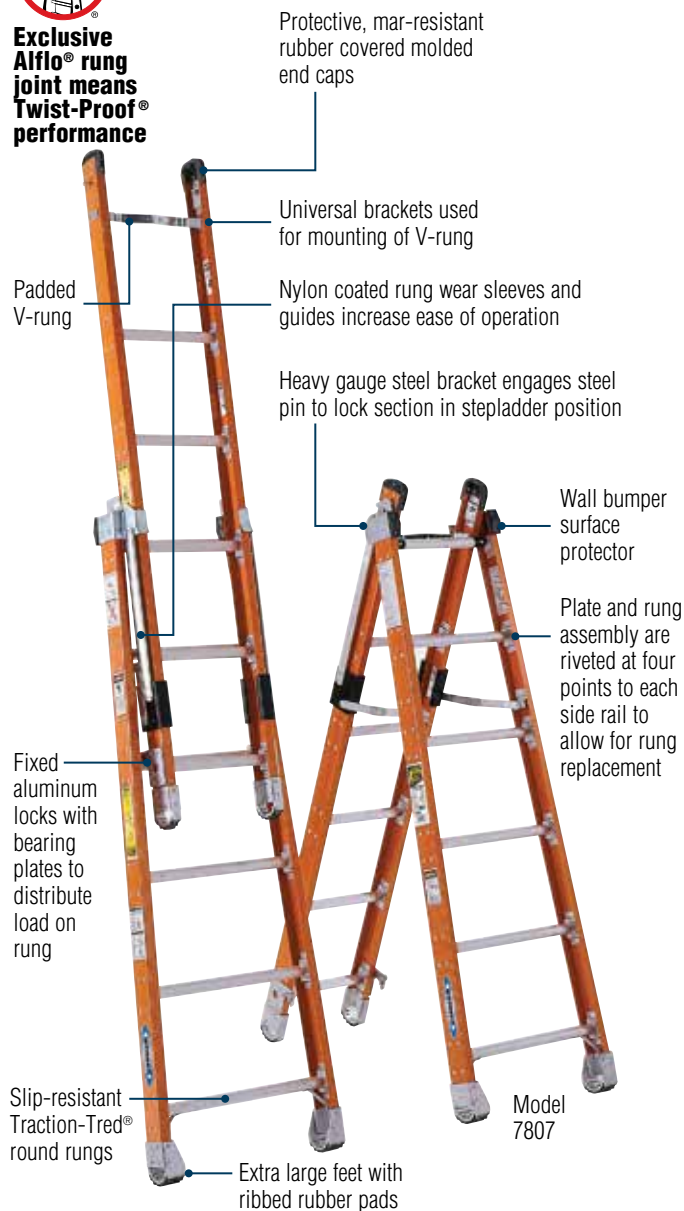

SPECIFICATIONS

Model No.	Stepladder Size	Width at Flared Base (outside rails)	Stepladder Spread to Outside of Shoes	Length of Ladder in Closed Position	Extended Ladder Working Length	Approx. Cu. Ft. Per Unit	Approx. Shipping Wt. Lbs.
7806	6'	23-1/4"	46-1/2"	72-3/4"	9-1/2'	8.6	33.5
7807	7'	24-1/4"	53-1/2"	84-3/4"	11-1/2'	10.3	37.0
7808	8'	25-1/4"	60-1/2"	96-3/4"	13-1/2'	12.1	40.5

††Designed for one or two person jobs. Note: When used as a double stepladder, the maximum load per side, including person and materials, shall not exceed the duty rating of ladder.

DIMENSIONS

	Parallel Section	Flared Section
Overlap	3'	—
Rails:	3-1/8" wide	3-1/8" wide
Flange:	1-3/16" wide	1-3/16" wide
Ladder Width:	14-1/2" outside rails	14-1/2" outside rails at top
Ladder in Closed Position:	—	7-7/8" deep

M7100-I SERIES Manhole Ladder

375lbs. LOAD CAPACITY PER SIDE

TYPE IAA
DUTY RATING



Exclusive Alflo® rung joint means Twist-Proof® performance

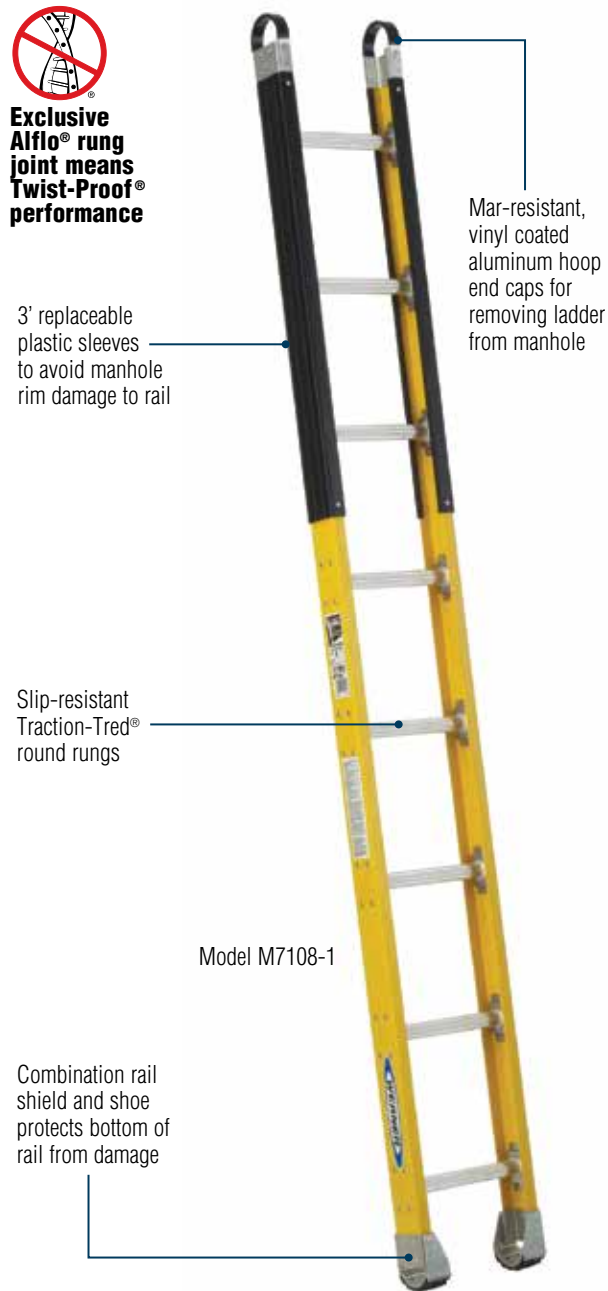

SPECIFICATIONS

Model No.	Total Length	Approx. Cu. Ft. Per Unit	Approx. Shipping Wt. Lbs.
M7108-1	8'	3.0	20.0
M7110-1	10'	3.7	24.0
M7112-1	12'	4.4	28.0
M7114-1	14'	5.2	32.0
M7116-1	16'	5.9	39.5

DIMENSIONS

Rails:	3-5/16" wide	Rungs:	1-1/4"
Flange:	1-3/16" wide	Ladder Width:	12-3/8" outside shoes



S7900SERIES Interchangeable Tapered Sectional Ladder

375lbs. LOAD CAPACITY **3 SECTIONS**

TYPE IAA
DUTY RATING

300lbs. LOAD CAPACITY **4 SECTIONS**

TYPE IA
DUTY RATING



Exclusive Alflo® rung joint means Twist-Proof® performance



Hand operated taper-lock

Slip-resistant Traction-Tred® round rungs



Optional molded end cap (Model S7901)

Durable rail shield and shoe bracket

Shoe with slip-resistant pad and spur plate

Mar-resistant end caps

- Maximum number of sections to be used – 4

Top Section Model S7906-3

Middle Section Model S7906-2

Rungs nest to top channel of sections when sections are joined

Base Section Model S7906-1

SPECIFICATIONS

Model No.	Description	Top of Section	Bottom of Section	Approx. Cu. Ft. Per Unit	Approx. Shipping Wt. Lbs.
S7906-1	6' tapered base with swivel shoes	15-3/4"	19-3/4"	2.3	17.0
S7906-2	6' intermediate	15-3/4"	18-3/4"	3.5	15.5
S7906-3	6' top with molded end cap	16-3/16"	18-3/4"	3.4	13.0
S7901 (Accessory)	End cap for middle or base sections	N/A	N/A	0.1	1.0 ea.

ASSEMBLY DESCRIPTION

Quantity of Sections	Model No.	Total Assembled Size
1	S7906-1 base	6' 2"
1	S7906-1 base	
1	S7906-2 middle	15' 11"
1	S7906-3 top	
1	S7906-1 base	
2	S7906-2 middle	20' 11"
1	S7906-3 top	

DIMENSIONS

Rails:	3-5/16" wide
Flange:	1-3/16" wide
Rungs:	1-1/4" diameter

9500-2/9500-1SERIES All-Fiberglass Extension/Straight Ladder

300lbs. LOAD CAPACITY

TYPE IA
DUTY RATING

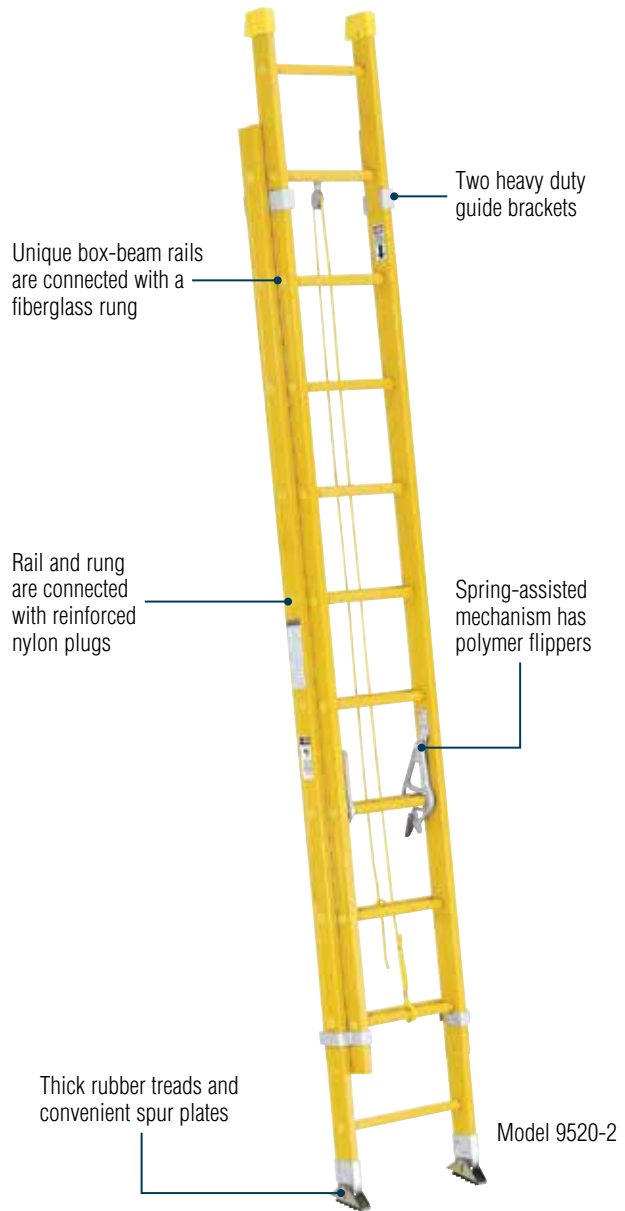

Unique box-beam rails are connected with a fiberglass rung

Two heavy duty guide brackets

Rail and rung are connected with reinforced nylon plugs

Spring-assisted mechanism has polymer flippers

Thick rubber treads and convenient spur plates

Model 9520-2

SPECIFICATIONS

Model No.	Total Length of Sections	Max. Working Length	Approx. Cu. Ft. Per Unit	Approx. Shipping Wt. Lbs.	Single Ladder Model No.	Approx. Total Length	Approx. Cu. Ft. Per Unit	Approx. Shipping Wt. Lbs.
9516-2	16'	13'	8.3	41.0	9508-1	8'	5.5	18.0
9520-2	20'	17'	10.2	49.0	9510-1	10'	6.8	22.0
9524-2	24'	21'	12.2	56.0	9512-1	12'	8.0	26.0
9528-2	28'	25'	14.1	64.0	9514-1	14'	9.4	30.0
9532-2	32'	29'	16.0	72.0	9516-1	16'	10.7	34.0
					9518-1	18'	11.2	38.0
					9520-1	20'	12.5	42.0

DIMENSIONS

Rails:	3-1/4" wide	Fly Width:	15-1/2" outside rails
Flange:	1-3/16" wide	Base Width:	19" outside shoes
Rungs:	1-1/4"		

SPFOO-I/TPFOO-ISERIES Posting Ladder

300lbs. LOAD CAPACITY

TYPE IA
DUTY RATING

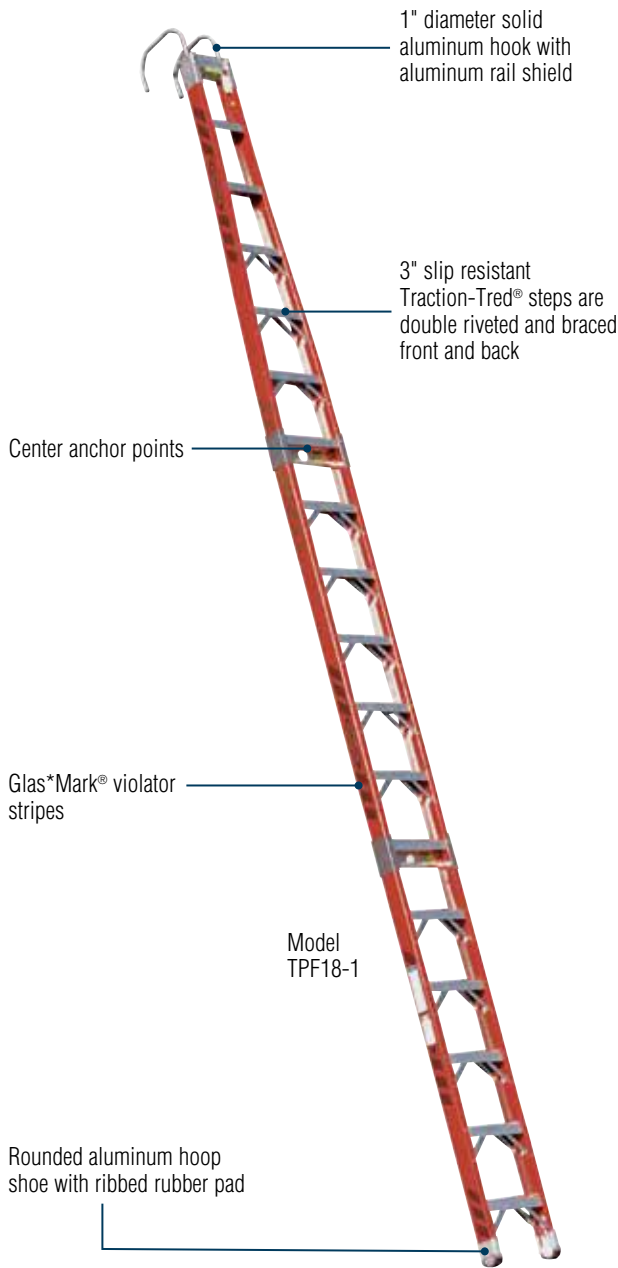

SPECIFICATIONS

Model No.	Total Length	Length for Shipping	Approx. Cu. Ft. Per Unit	Approx. Shipping Wt. Lbs.
Straight Posting Ladders (not shown above)				
SPF14-1	14'	15'	6.0	38.0
SPF16-1	16'	17'	6.8	43.0
SPF18-1	18'	19'	7.6	49.0
SPF20-1	20'	21'	8.4	58.0
Tapered Posting Ladders				
TPF14-1	14'	15'	6.0	37.0
TPF16-1	16'	17'	6.8	42.0
TPF18-1	18'	19'	7.6	48.0
TPF20-1	20'	21'	8.4	57.0

DIMENSIONS

Rails:	3-5/16" wide	Steps:	2-7/8" wide
Flange:	1-3/16" wide	Base Width:	14-5/8"

S7700SERIES Interchangeable Parallel Sectional Ladder

250lbs. LOAD CAPACITY

TYPE I
DUTY RATING

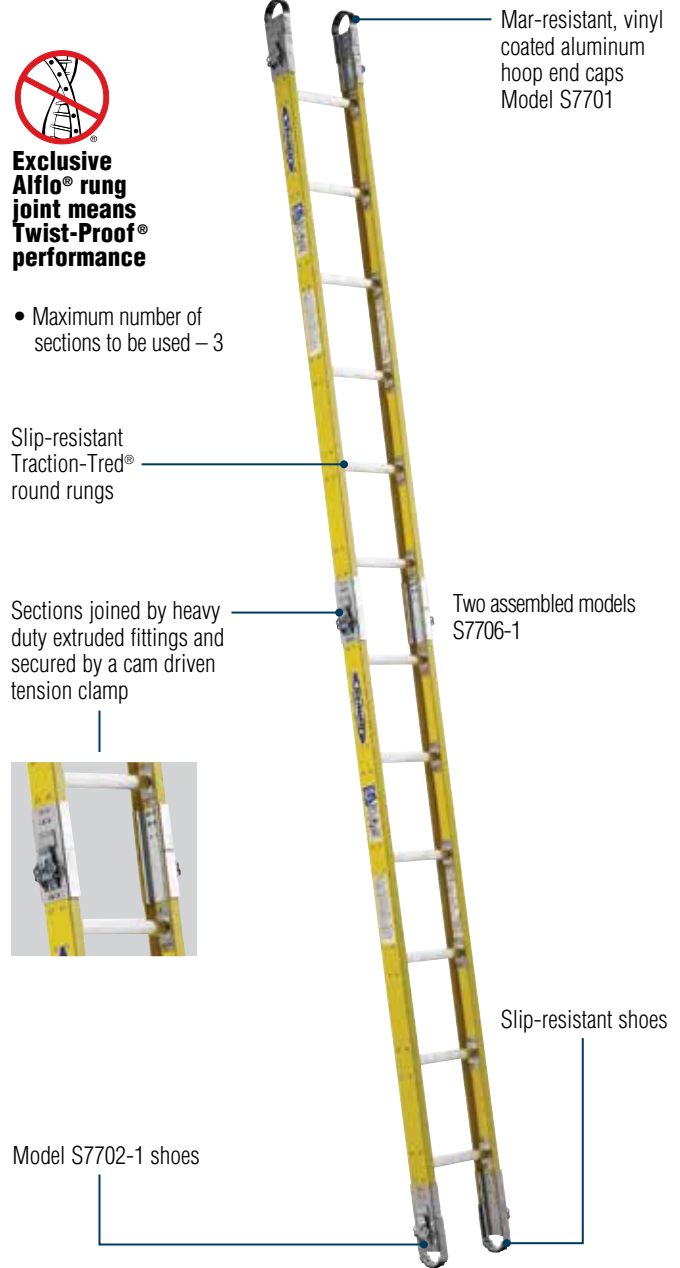

SPECIFICATIONS

Model No.	Description	Top of Section	Bottom of Section	Approx. Cu. Ft. Per Unit	Approx. Shipping Wt. Lbs.
S7706-1	For manhole use - 6' length	12" wide	12" wide	2.1	15.5
End Caps and Shoes					
S7701	End cap (2 required)	N/A	N/A	0.1	1.5 ea.
S7702-1	Shoe with black EPDM pad (2 required)	N/A	N/A	0.1	1.5 ea.
S7702-2	Shoe with gray EPDM pad (2 required) Buna N Pad - Oil resistant	N/A	N/A	0.1	1.5 ea.

ASSEMBLY DESCRIPTION

Max. No. of Sections	Approx. Max. Assembled Length
(3) assembled 6' sections with (1) pair of end caps and (1) pair of shoes	19'

DIMENSIONS

Rails:	3-5/16" wide
Flange:	1-3/16" wide
Rungs:	1-1/4" diameter



400SERIES Stepladder

375lbs. LOAD CAPACITY

TYPE IAA
DUTY RATING



Model 406

T400SERIES Multi-Use Twin Stepladder®††

375lbs. LOAD CAPACITY PER SIDE

TYPE IAA
DUTY RATING



Model T406

- Optional black molded pail shelf kit, model no. PK76-3

SPECIFICATIONS

NOTE: Type IAA duty rating is for stepladders up to 12 ft.

Model No.	Size	Approx. Width	Approx. Spread	Approx. Cu. Ft. Per Unit	Approx. Shipping Wt. Lbs.
404	4'	21-1/4"	30-1/8"	4.8	16.0
406	6'	24-3/4"	42-7/16"	8.1	24.0
408	8'	28-1/4"	54-3/4"	12.2	33.5
410	10'	31-3/4"	67"	17.0	43.5
412	12'	35-1/4"	79-3/8"	22.5	54.5

300lbs. LOAD CAPACITY

TYPE IA
DUTY RATING

414	14'	38-5/8"	91-11/16"	28.2	65.0
416	16'	42-1/8"	104"	34.7	77.5

DIMENSIONS

Top:	7" x 14"	Steps:	3" wide
Front Rails:	3-1/8" wide	Rear Rails:	1-3/4" wide
Front Flange:	1-1/8" wide	Rear Flange:	1" wide

SPECIFICATIONS

Model No.	Size	Approx. Width	Approx. Spread	Approx. Cu. Ft. Per Unit	Approx. Shipping Wt. Lbs.
T404	4'	21-1/4"	36-1/4"	5.0	21.5
T406	6'	24-3/4"	50-1/4"	8.8	31.0
T408	8'	28-1/4"	64-1/4"	13.3	42.0
T410	10'	31-3/4"	78-1/4"	18.7	55.0
T412	12'	35-1/4"	92-1/4"	25.0	69.0

††Designed for one or two person jobs. Note: When used as a double stepladder, the maximum load per side, including person and materials, shall not exceed the duty rating of ladder.

DIMENSIONS

Top:	8-1/4" x 14"	Steps:	3" wide
Rails:	3-1/8" wide	Flange:	1-1/8" wide

P400SERIES Platform Ladder

375lbs. LOAD CAPACITY

TYPE IAA
DUTY RATING

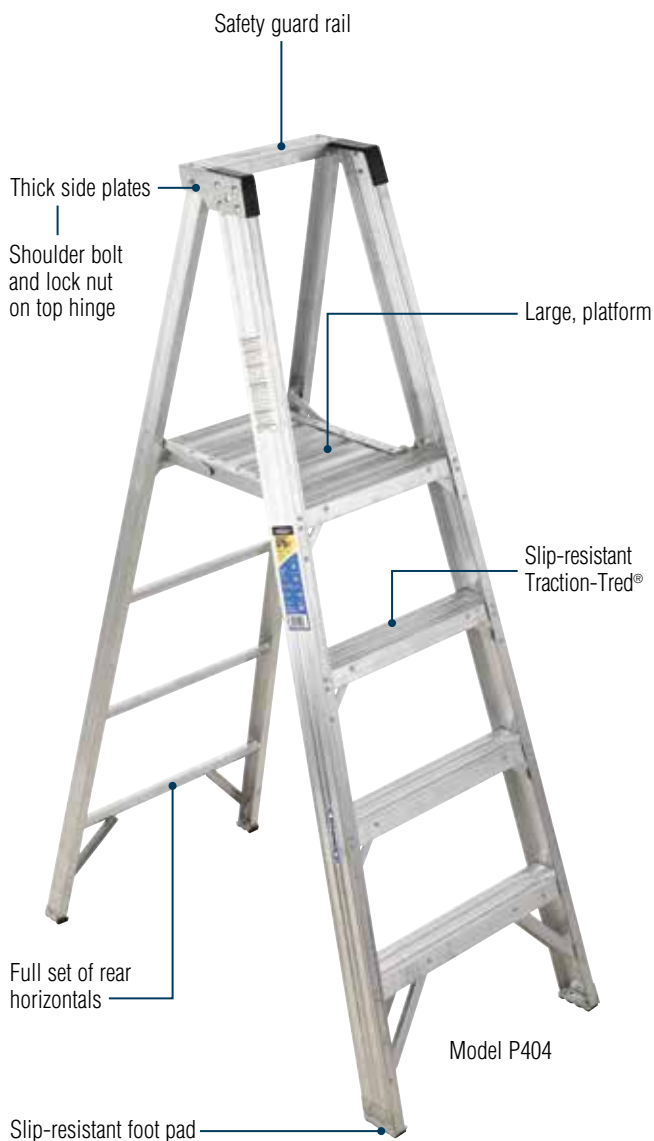

- Internal spreaders on 8' and above

SPECIFICATIONS NOTE: Type IAA duty rating is for platforms ranging in size from 4' to 8'

Model No.	Height (Size) to Platform	Rail Length	Approx. Width	Approx. Spread	Approx. Cu. Ft. Per Unit	Approx. Shipping Wt. Lbs.
P404	4'	6'	24-3/4"	42-1/16"	7.1	25.0
P406	6'	8'	28-1/4"	54-3/4"	10.1	33.5
P408	8'	10'	31-3/4"	79-1/2"	20.3	45.5

300lbs. LOAD CAPACITY

TYPE IA
DUTY RATING

P410	10'	12'	35-1/4"	79-3/8"	20.3	54.5
P412	12'	14'	38-3/4"	91-11/16"	25.2	66.0
P414	14'	16'	42-1/4"	104"	31.1	79.5

DIMENSIONS

Platform:	12-5/8" x 15"	Steps:	3" wide
Front Rails:	3-1/8" wide	Rear Rails:	1-3/4" wide
Front Flange:	1-1/8" wide	Rear Flange:	1" wide

370SERIES Stepladder

300lbs. LOAD CAPACITY

TYPE IA
DUTY RATING

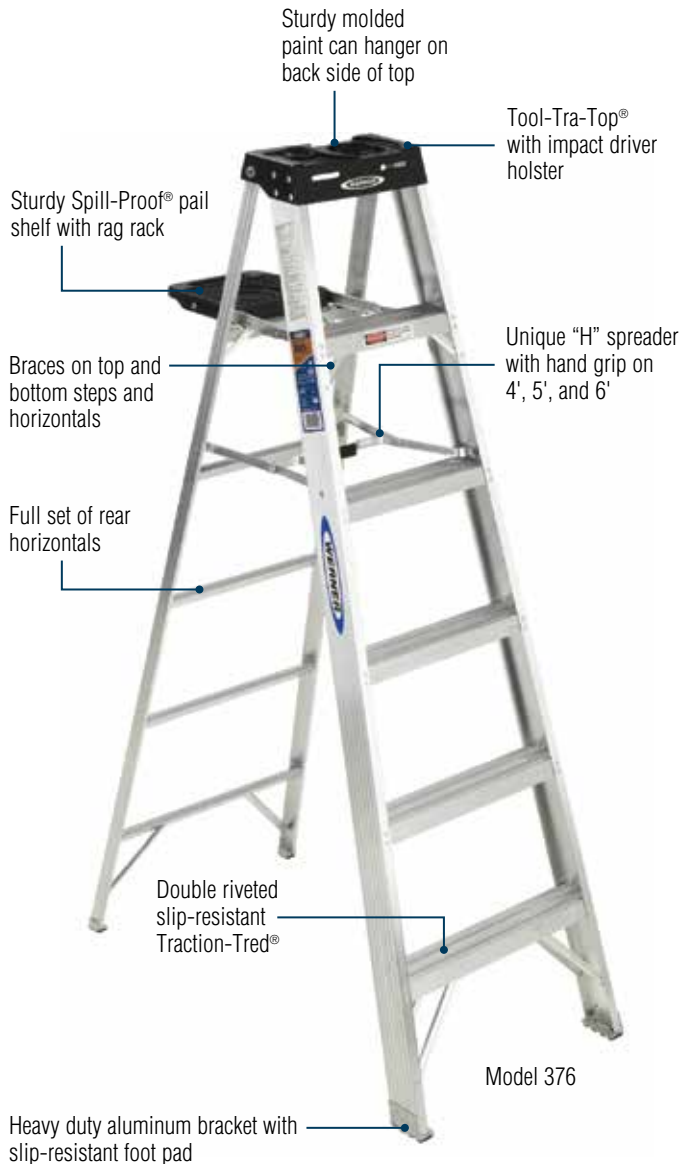

- External Pinch-Proof™ spreaders on 3', 7', 8' and 10' models

SPECIFICATIONS

Model No.	Size	Approx. Width	Approx. Spread	Approx. Cu. Ft. Per Unit	Approx. Shipping Wt. Lbs.
373	3'	17-3/4"	23-3/8"	1.5	9.0
374	4'	19-1/2"	29-1/2"	2.1	11.0
375	5'	21-1/4"	35-3/4"	2.8	13.5
376	6'	23"	41-7/8"	3.5	15.5
378	8'	26-1/2"	54-1/4"	5.1	22.5
310	10'	30"	66-1/2"	7.0	31.0

DIMENSIONS

Top:	5-1/8" x 12-1/8"	Steps:	3" wide
Front Rails:	3" wide	Rear Rails:	1-1/4" wide
Front Flange:	7/8" wide	Rear Flange:	1" wide



T370SERIES Multi-Use Twin Stepladder††

300lbs. LOAD CAPACITY PER SIDE

TYPE IA
DUTY RATING

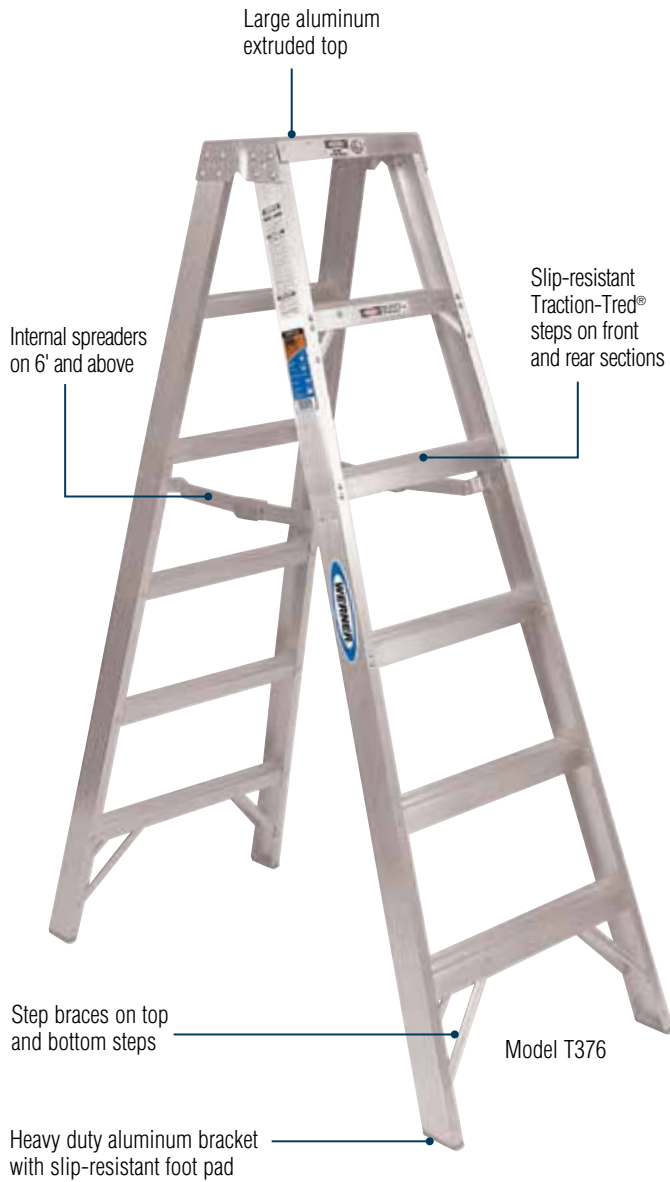

Model T376

- External Pinch-Proof™ spreaders on 4' model

SPECIFICATIONS

Model No.	Size	Approx. Width	Approx. Spread	Approx. Cu. Ft. Per Unit	Approx. Shipping Wt. Lbs.
T374	4'	21-1/4"	36"	3.5	14.5
T376	6'	24-3/4"	50"	5.7	21.5
T378	8'	28-1/4"	64"	8.2	31.0
T310	10'	31-3/4"	78"	11.1	43.0

††Designed for one or two person jobs. Note: When used as a double stepladder, the maximum load per side, including person and materials, shall not exceed the duty rating of ladder.

DIMENSIONS

Top:	8-1/4" x 14"	Steps:	3" wide
Rails:	3" wide	Flange:	7/8" wide

P370SERIES Platform Ladder

300lbs. LOAD CAPACITY

TYPE IA
DUTY RATING

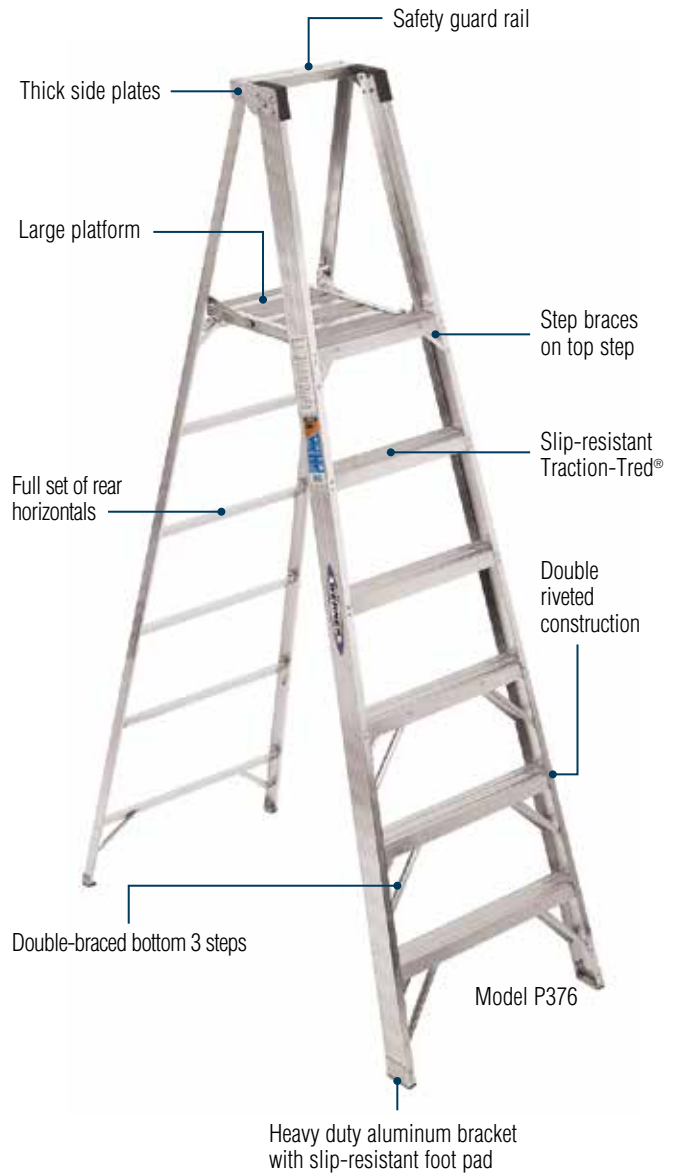

Model P376

- External Pinch-Proof™ spreaders on 8' model

SPECIFICATIONS

Model No.	Height (Size) to Platform	Rail Length	Approx. Width	Approx. Spread	Approx. Cu. Ft. Per Unit	Approx. Shipping Wt. Lbs.
P372	2'	4'	21-1/4"	30"	3.0	12.0
P373	3'	5'	23"	36-1/4"	3.9	14.5
P374	4'	6'	24-3/4"	42-3/4"	4.9	17.0
P376	6'	8'	28-1/4"	54-3/4"	7.1	23.0
P378	8'	10'	31-3/4"	67"	8.4	32.0

DIMENSIONS

Platform:	12-5/8" x 18"	Steps:	3" wide
Front Rails:	3" wide	Rear Rails:	1-1/4" wide
Front Flange:	7/8" wide	Rear Flange:	1" wide

PT370SERIES Stockr's Ladder®††

300lbs. LOAD CAPACITY PER SIDE

TYPE IA
DUTY RATING



Model PT374

- Available with 4 casters to allow for easy 360° mobility
- Easy to handle and folds to a 10" width for storage
- Unique combination of one person, two person†† and platform ladder use
- Internal Pinch-Proof™ aluminum spreaders on 8' and 10' models

SPECIFICATIONS

Model No.	Height (Size) to Platform	Rail Length	Approx. Width	Approx. Spread	Approx. Cu. Ft. Per Unit	Approx. Shipping Wt. Lbs.	Model No. with Casters	Approx. Shipping Wt. Lbs.
PT372	2'	4'	21-1/4"	36"	5.1	21.0	PT372-4C	27.5
PT374	4'	6'	24-3/4"	50-1/2"	8.9	27.0	PT374-4C	33.5
PT376	6'	8'	28-1/4"	65-1/4"	13.5	36.0	PT376-4C	42.5
PT378	8'	10'	31-3/4"	81-1/2"	19.0	46.5	PT378-4C	54.0
PT310	10'	12'	34-1/4"	96"	24.5	58.5	PT310-4C	66.5

†† Designed for one or two person jobs. Note: When used as a double stepladder, the maximum load per side, including person and materials, shall not exceed the duty rating of ladder.

DIMENSIONS

Platform:	12-3/4" x 22"	Steps:	3" wide
Rails:	3" wide	Flange:	3/4" wide

SH378MODEL Shelf Ladder

300lbs. LOAD CAPACITY

TYPE IA
DUTY RATING

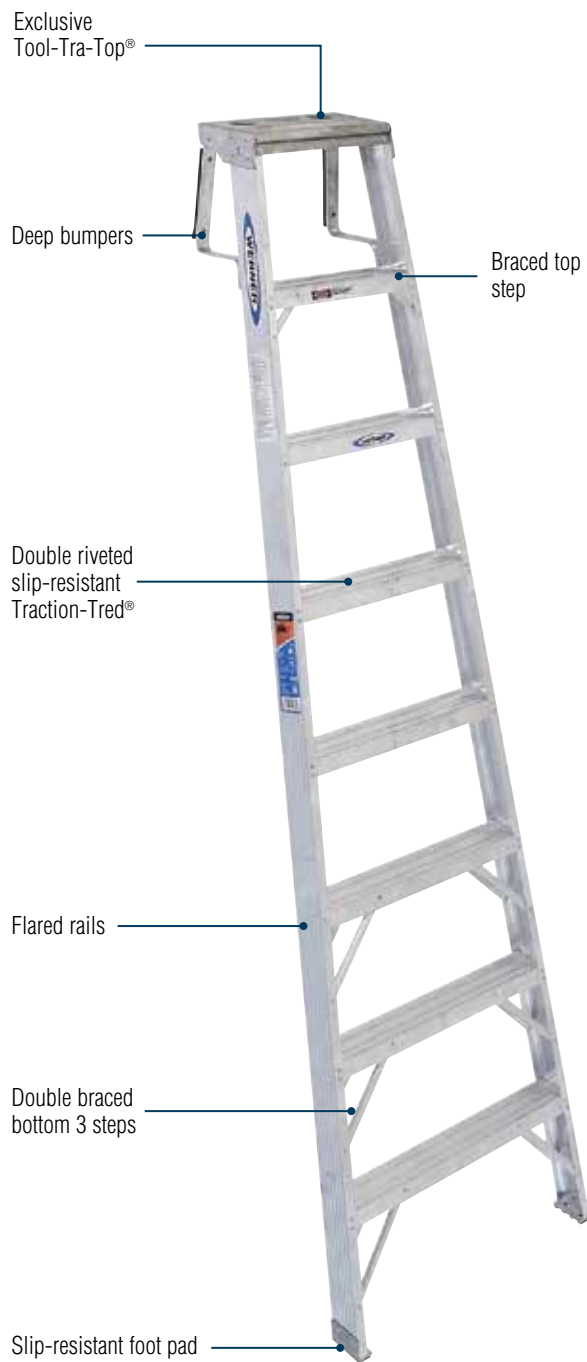

SPECIFICATIONS

Model No.	Size	Approx. Width	Approx. Cu. Ft. Per Unit	Approx. Shipping Wt. Lbs.
SH378	8'	28-1/4"	3.9	15.5

DIMENSIONS

Top:	7" x 14"	Steps:	3" wide
Rails:	3" wide	Flange:	7/8" wide



360SERIES Stepladder

250lbs. LOAD CAPACITY

TYPE I
DUTY RATING

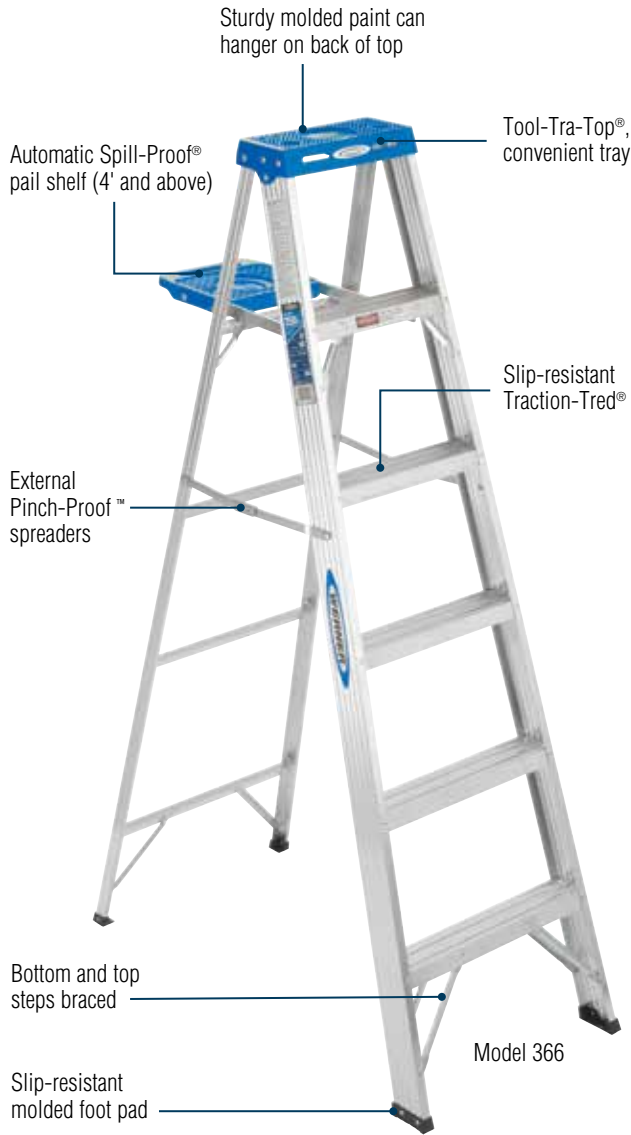

Model 366

350SERIES Stepladder

225lbs. LOAD CAPACITY

TYPE II
DUTY RATING



Model 356

SPECIFICATIONS

Model No.	Size	Approx. Width	Approx. Spread	Approx. Cu. Ft. Per Unit	Approx. Shipping Wt. Lbs.
363	3'	17"	23-1/4"	1.7	8.0
364	4'	18-1/2"	29-1/4"	2.4	10.5
365	5'	20"	35-1/2"	3.1	12.5
366	6'	21-1/2"	41-5/8"	3.9	14.5
368	8'	24-1/2"	54"	5.7	21.5

DIMENSIONS

Top:	5" x 12-3/8"	Steps:	3" wide
Front Rails:	3" wide	Rear Rails:	1-1/8" wide
Front Flange:	3/4" wide	Rear Flange:	1" wide

SPECIFICATIONS

Model No.	Size	Approx. Width	Approx. Spread	Approx. Cu. Ft. Per Unit	Approx. Shipping Wt. Lbs.
354	4'	18-1/2"	29-1/4"	2.4	10.0
355	5'	20"	35-1/2"	3.1	12.0
356	6'	21-1/2"	41-5/8"	3.9	13.5

DIMENSIONS

Top:	4-5/8" x 12-1/2"	Steps:	3" wide
Front Rails:	3" wide	Rear Rails:	1-1/8" wide
Front Flange:	3/4" wide	Rear Flange:	1" wide

260SERIES Platform Ladder

200lbs. LOAD CAPACITY

TYPE III
DUTY RATING

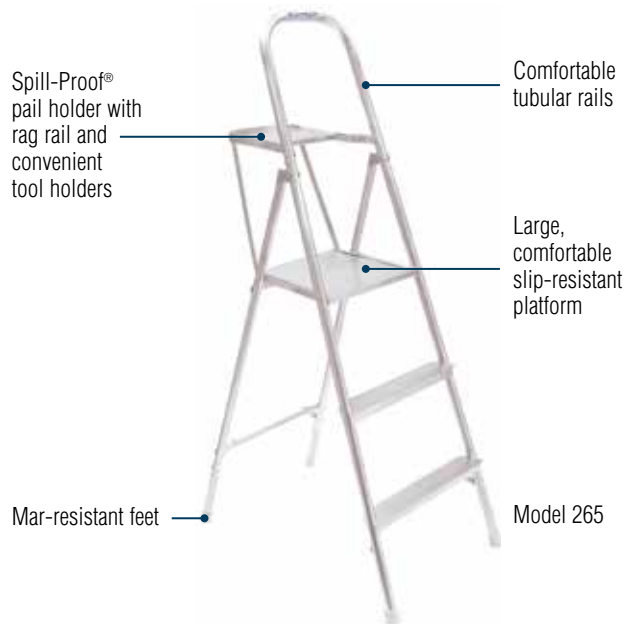

Model 265

- Compact for convenient storage – folds to 3-1/2"

SPECIFICATIONS

Model No.	Height (Size) to Platform	Rail Length	Approx. Width	Approx. Spread	Approx. Cu. Ft. Per Unit	Approx. Shipping Wt. Lbs.
264	22-1/2"	4-1/2"	20"	25-1/2"	2.0	11.5
265	33-1/2"	5-1/2"	21-1/2"	33-1/4"	2.6	15.0

DIMENSIONS

Platform:	14-1/2" x 12"	Steps:	3" wide
Front Tubular Rails:	1-1/8" diameter	Rear Tubular Rails:	1" diameter

244MODEL Utility Ladder

200lbs. LOAD CAPACITY

TYPE III
DUTY RATING



Model 244

- Lightweight – easy action open-close
- Compact for convenient storage – folds to 3"

SPECIFICATIONS

Model No.	Rail Length	Approx. Width	Approx. Spread	Approx. Cu. Ft. Per Unit	Approx. Shipping Wt. Lbs.
244	3-1/2"	18-1/2"	22-1/2"	1.4	9.0

DIMENSIONS

Front Tubular Rails:	1-1/8" diameter	Steps:	6" wide
Rear Tubular Rails:	1" diameter	Height to 2nd Step:	23"

DMERCHANDISING MODULAR LADDER DISPLAYS & FIXTURES

37 DISPLAY RACK













- Modular design for flexible retail footprint
- Easier access and organized ladder display
- Merchandises ladders and accessories
- Werner Performance System® signage included

SPECIFICATIONS

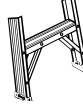
Model No.	No. of Ladders in Fixture	Overall dimensions	Method of Shipping	Approx. Shipping Wt. Lbs.
37 Display Rack	7	24-3/4" x 48" x 45-1/2"	UPS or Fed Ex	65.0

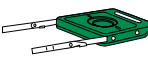

ALUMINUM STEPLADDER COMPARISON CHART

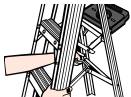
Features and Benefits	400 SERIES	T400 SERIES	P400 SERIES	370 SERIES	T370 SERIES	P370 SERIES	PT370 SERIES	360 SERIES	350 SERIES
	TYPE IAA/IA	TYPE IAA	TYPE IAA/IA	TYPE IA	TYPE IA	TYPE IA	TYPE IA	TYPE I	TYPE II
 Slip-resistant foot pad	●	●	●	●	●	●	●	●	●
 Slip-resistant Traction-Tred® steps	●	●	●	●	●	●	●	●	●
 Dual drill HolsterTop®	●								
 External spreaders	4', 5', 8' models	4', 6' models		3', 8', 10' models				●	●
Designed for one or two person jobs		●			●		●		
 Knee-braced top & bottom steps	●	●	●	●	●	●	●	●	●
 Aluminum top	●	●	●		●	●			
Full set of rear horizontals	●		●	●		●			
 Spill-Proof® pail shelf with rag rack				●				●	●
 Tool-Tra-Top®	●			●				●	●
 Safety guard rail			●			●	●		
 Platform for comfortable work area			●			●	●		
 Paint can hanger on top				●				●	●
 H-spreader for one-handed carry & close				●					



SSA00SERIES Step Stand

375lbs. LOAD CAPACITY

TYPE IAA
DUTY RATING



SPECIFICATIONS

Model No.	Size	Max. Standing Height	Approx. Width	Approx. Spread	Approx. Cu. Ft. Per Unit	Approx. Shipping Wt. Lbs.
SSA02	2'	20"	17"	21"	2.6	16.0
SSA03	3'	30"	18-3/4"	27-1/2"	4.0	21.0

DIMENSIONS

Top:	9" x 14"	Steps:	6" wide
Front Rails:	6" wide	Rear Rails:	1-7/8" wide
Front Flange:	1-1/8" wide	Rear Flange:	1-3/16" wide

150BMODEL Step Stool

300lbs. LOAD CAPACITY

TYPE IA
DUTY RATING

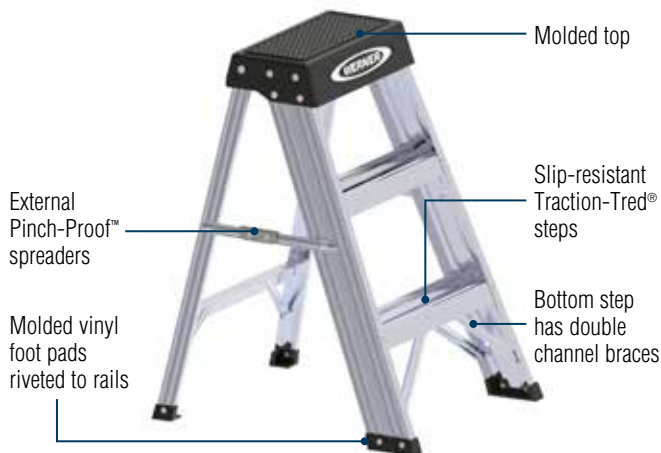

- Ideal for plant, office and home applications

SPECIFICATIONS

Model No.	Size	Approx. Width	Approx. Spread	Approx. Cu. Ft. Per Unit	Approx. Shipping Wt. Lbs.
150B	2'	17"	19"	1.9	5.5

DIMENSIONS

Top:	7" x 12-3/8"	Steps:	3" wide
Front Rails:	3" wide	Rear Rails:	1-1/8" wide
Front Flange:	3/4" wide	Rear Flange:	1" wide

TW370-30SERIES Portable Work Stand††

300lbs. LOAD CAPACITY PER SIDE

TYPE IA
DUTY RATING



- Extra wide for versatile use as work stand, stage or material support
- Lightweight and portable

SPECIFICATIONS

Model No.	Size	Approx. Width	Approx. Spread	Approx. Cu. Ft. Per Unit	Approx. Shipping Wt. Lbs.
TW372-30	2'	33"	22"	4.0	12.5
TW373-30	3'	34-3/4"	29"	5.6	17.5
TW374-30	4'	36-1/2"	36"	7.8	24.0

††Designed for one or two person jobs. Note: When used as a double stepladder, the maximum load per side, including person and materials, shall not exceed the duty rating of ladder.

DIMENSIONS

Top:	8" x 30"	Steps:	3" wide
Rails:	3" wide	Flange:	7/8" wide

T372MODEL Twin Step Stool††

300lbs. LOAD CAPACITY PER SIDE

TYPE IA
DUTY RATING

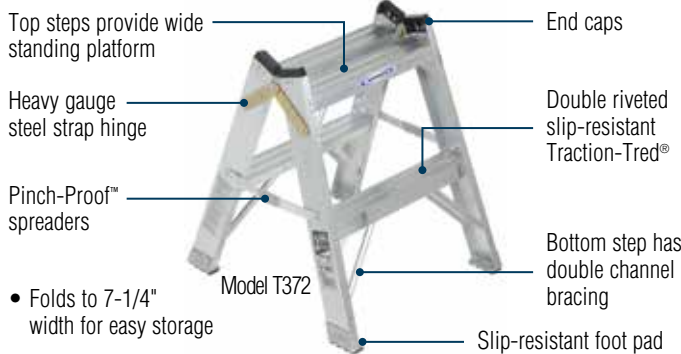

- Folds to 7-1/4" width for easy storage

Note: Planks or platforms shall be secured to the step stools. The ends of each plank or platform shall extend beyond the outside edge of each step stool by a minimum of 4 inches and a maximum of 10 inches.

SPECIFICATIONS

Model No.	Size	Approx. Width	Approx. Spread	Approx. Cu. Ft. Per Unit	Approx. Shipping Wt. Lbs.
T372	2'	21-1/4"	23-3/8"	2.3	9.0

††Designed for one or two person jobs. Note: When used as a double stepladder, the maximum load per side, including person and materials, shall not exceed the duty rating of ladder.

DIMENSIONS

Rails:	3" wide	Flange:	7/8" wide
Steps:	3" wide		



500-1SERIES Round Rung Straight Ladder

375lbs. LOAD CAPACITY

TYPE IAA
DUTY RATING



Exclusive Alflo® rung joint means Twist-Proof® performance

Extra heavy duty I-beam rails

Traction-Tred® deeply serrated aluminum round rungs



Model 508-1

SPECIFICATIONS

NOTE: Type IAA duty rating is for single ladders up to 16 ft.

Model No.	Total Length	Approx. Cu. Ft. Per Unit	Approx. Shipping Wt. Lbs.
508-1	8'	2.9	16.5
510-1	10'	3.6	20.0
512-1	12'	4.3	24.0
514-1	14'	5.0	27.5
516-1	16'	5.7	37.0

300lbs. LOAD CAPACITY

TYPE IA
DUTY RATING

518-1	18'	6.4	41.0
520-1	20'	7.1	45.5
524-1	24'	14.0	60.5

DIMENSIONS

	Rails:	Flange:	Round Rungs:	Base Width:
8' to 14'	3" wide	1-3/16"	1-1/4"	16-7/8"
16' to 20'	3" wide	1-1/4"	1-1/4"	16-7/8"
24'	4" wide	1-3/8"	1-1/4"	20-5/8"

D500-2SERIES D-Rung Extension Ladder

375lbs. LOAD CAPACITY PER SIDE

TYPE IAA
DUTY RATING



Exclusive Alflo® rung joint means Twist-Proof® performance

4-piece pulley with 3/8" rope. 36' to 48' models have heavy duty rope and double pulley system

Slip-resistant Traction-Tred® D-rungs

Base and fly separate easily for use as an extension or two single sections

Internal guides

Heavy duty, self-aligning, free-swinging shoe with slip-resistant tread and replaceable steel spur plate

Mar-resistant end caps notched for easy separation of sections

Extra heavy duty I-beam rails

Interlocking side rails

Rugged spring loaded locks

Molded slip-resistant shoes



Model D520-2

SPECIFICATIONS

NOTE: Type IAA duty rating is for extension ladders up to 32 ft.

Model No.	Total Length of Sections	Max. Working Length	Approx. Cu. Ft. Per Unit	Approx. Shipping Wt. Lbs.
D520-2	20'	17'	8.8	42.0
D524-2	24'	21'	10.4	49.0
D528-2	28'	25'	12.1	65.5
D532-2	32'	29'	13.8	74.0

300lbs. LOAD CAPACITY

TYPE IA
DUTY RATING

D536-2	36'	32'	15.4	90.0
D540-2	40'	35'	17.0	99.5
D544-2	44'	39'	21.4	131.0
D548-2	48'	43'	23.3	142.5

DIMENSIONS

Rails:	3-1/4" wide	Rungs:	1-3/4"
Flange:	1-3/16" wide (20' & 24') 1-1/4" wide (28' to 48')	Base Section Width:	19-1/8" outside shoes 20-1/8" (44' & 48')

D1500-2/D1500-ISERIES D-Rung Extension/Straight Ladder

300lbs. LOAD CAPACITY

TYPE IA
DUTY RATING



Exclusive Alflo® rung joint means Twist-Proof® performance

Thick guide bracket engages full fly rail

Smooth operating pulley design

Slip-resistant Traction-Tred® D-rungs

Guide brackets

Rugged shoe rests flat or is held in spur position with Shu-Lok® feature

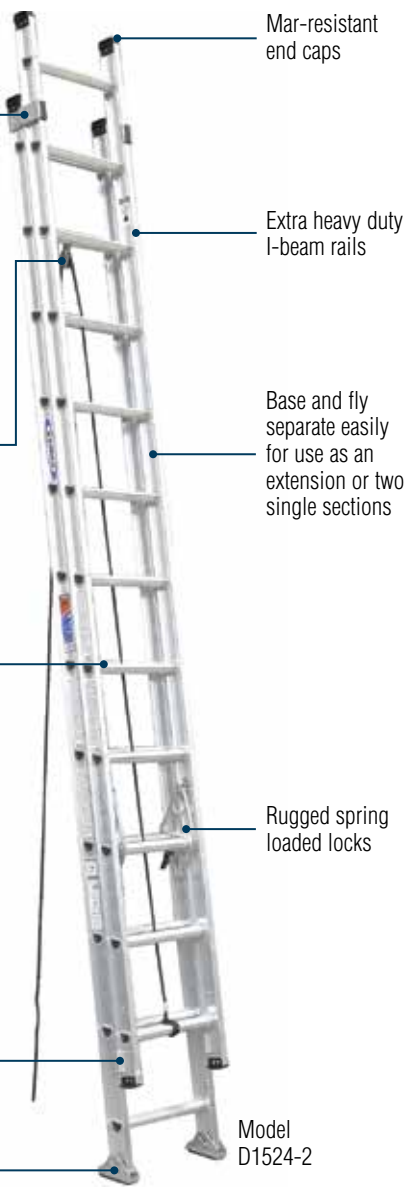

Model D1524-2

Mar-resistant end caps

Extra heavy duty I-beam rails

Base and fly separate easily for use as an extension or two single sections

Rugged spring loaded locks

560-3MODEL Round Rung Extension Ladder

250lbs. LOAD CAPACITY

TYPE I
DUTY RATING



Exclusive Alflo® rung joint means Twist-Proof® performance

Heavy duty rope and double pulley system lift fly and intermediate sections

Bottom base section with top fly section can be used as a 40' extension ladder

SPECIFICATIONS

Model No.	Total Length of Sections	Max. Working Length	Approx. Cu. Ft. Per Unit	Approx. Shipping Wt. Lbs.
560-3	60'	47'	26.8	179.0

DIMENSIONS

Rails:	4" wide	Rungs:	1-1/4"
Flange:	2" wide (base & intermediate sections) 1-3/8" wide (top fly section)	Base Width:	23-1/2"

SPECIFICATIONS

Model No.	Total Length of Sections	Max. Working Length	Approx. Cu. Ft. Per Unit	Approx. Shipping Wt. Lbs.	Single Ladder Model No.	Approx. Total Length	Approx. Cu. Ft. Per Unit	Approx. Shipping Wt. Lbs.
D1516-2‡	16'	13'	6.2	30.5	D1508-1	8'	3.6	14.5
D1520-2	20'	17'	7.7	37.0	D1510-1	10'	4.5	17.5
D1524-2	24'	21'	9.2	45.0	D1512-1	12'	5.4	21.5
D1528-2	28'	25'	10.7	56.0	D1514-1	14'	6.2	27.0
D1532-2	32'	29'	12.2	67.0	D1516-1	16'	7.1	32.5
D1536-2	36'	32'	13.7	80.0	D1518-1	18'	8.0	38.5
D1540-2	40'	35'	15.2	89.5	D1520-1	20'	8.9	43.5

‡ Note: D1516-2 is not equipped with rope and pulley

DIMENSIONS

Rails:	3" wide	Rungs:	1-3/4"
Flange:	1-1/8" wide	Base Width:	18-1/8" outside rails



D1800-2EQ/D1700-2SERIES Ext Ladder w/Integrated Leveling

250lbs. LOAD CAPACITY

TYPE I
DUTY RATING



Exclusive Alflo® rung joint means Twist-Proof® performance

THE Equalizer®
ELIMINATES UNEVEN GROUND



Factory installed adjustable EverLevel® leveling system exceeds OSHA and ANSI requirements

Easily adjustable in 3/8" increments up to 8-1/4"

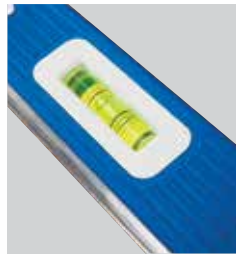

Convenient built-in bubble level



Dual action foot for use on hard or penetrable surfaces

Lightweight aluminum

Slip-resistant Traction-Tred® D-rungs

Heavy duty spring-loaded locks

Model D1820-2EQ

SPECIFICATIONS

Model No.	Total Length of Sections	Max. Working Length	Approx. Cu. Ft. Per Unit	Approx. Shipping Wt. Lbs.
D1816-2EQ‡	16'	13'	6.5	31.5
D1820-2EQ	20'	17'	8.1	37.5
D1824-2EQ	24'	21'	9.6	45.5
D1828-2EQ	28'	25'	11.2	56.0

225lbs. LOAD CAPACITY

TYPE II
DUTY RATING

Model No.	Total Length of Sections	Max. Working Length	Approx. Cu. Ft. Per Unit	Approx. Shipping Wt. Lbs.
D1716-2EQ‡	16'	13'	6.5	27.5
D1720-2EQ	20'	17'	8.1	32.5
D1724-2EQ	24'	21'	9.6	39.0
D1728-2EQ	28'	25'	11.2	48.5

‡ Note: D1816-2EQ and D1716EQ are not equipped with rope and pulley

DIMENSIONS

Rails:	3" wide	Fly Width:	14-1/4" outside rails
Flange:	1-1/16" wide	Base Width:	17-3/8" outside rails
Rungs:	1-3/4"		(20-3/4" to outside of feet)

D1300-2SERIES D-Rung Extension Ladder

250lbs. LOAD CAPACITY

TYPE I
DUTY RATING



Exclusive Alflo® rung joint means Twist-Proof® performance

Smooth operating pulley

Slip-resistant Traction-Tred® D-rungs

Durable shoe rests flat or is held in spur position with Shu-Lok® feature

Model D1320-2

Mar-resistant end caps

Interlocking side rails

Heavy duty modified I-beam side rails

Heavy duty spring loaded locks

SPECIFICATIONS

Model No.	Total Length of Sections	Max. Working Length	Approx. Cu. Ft. Per Unit	Approx. Shipping Wt. Lbs.
D1316-2‡	16'	13'	5.8	26.0
D1320-2	20'	17'	7.2	32.5
D1324-2	24'	21'	8.6	40.0
D1328-2	28'	25'	10.0	50.5
D1332-2	32'	29'	11.5	63.5
D1336-2	36'	32'	13.0	77.5
D1340-2	40'	35'	14.4	85.5

‡ Note: D1316-2 is not equipped with rope and pulley

DIMENSIONS

Rails:	3" wide	Rungs:	1-3/4"
Flange:	1-1/16" wide	Base Width:	17-3/8" outside rails

D1200-2SERIES D-Rung Extension Ladder

225lbs. LOAD CAPACITY

TYPE II
DUTY RATING



Exclusive Alflo® rung joint means Twist-Proof® performance

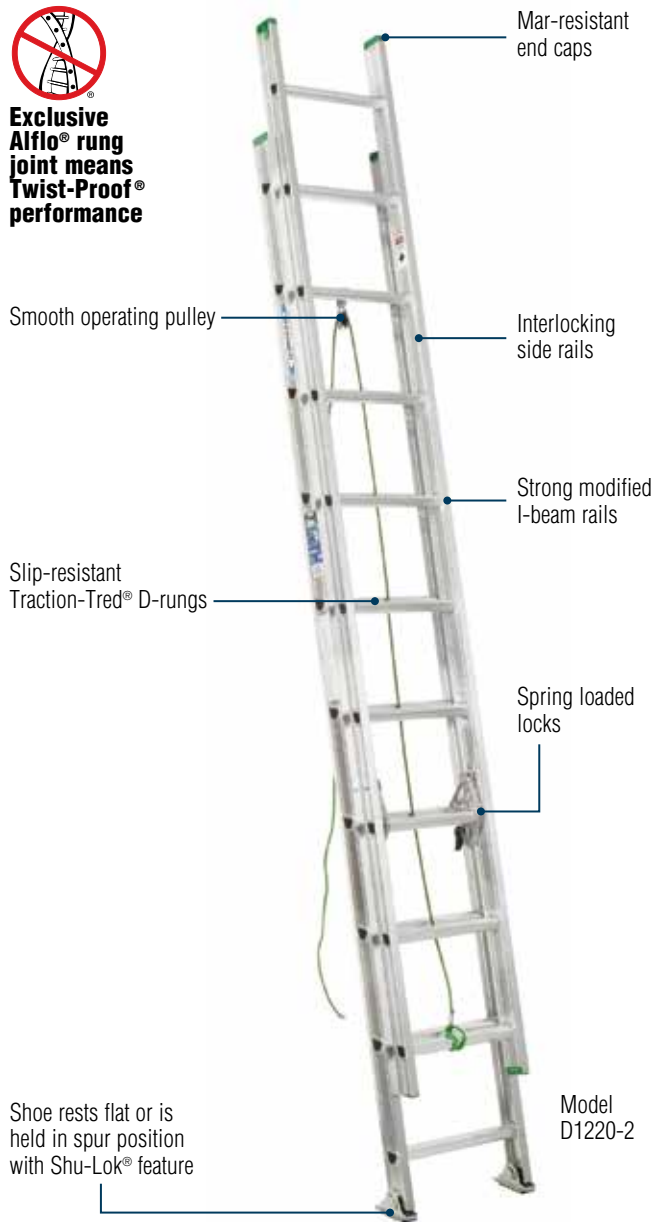

SPECIFICATIONS

Model No.	Total Length of Sections	Max. Working Length	Approx. Cu. Ft. Per Unit	Approx. Shipping Wt. Lbs.
D1216-2†	16'	13'	5.8	22.0
D1220-2	20'	17'	7.2	27.0
D1224-2	24'	21'	8.6	33.5
D1228-2	28'	25'	10.0	43.0
D1232-2	32'	29'	11.5	54.0
D1236-2	36'	32'	13.0	62.5
D1240-2	40'	35'	14.4	73.5

† Note: D1216-2 is not equipped with rope and pulley

DIMENSIONS

Rails:	3" wide	Rungs:	1-3/4"
Flange:	1" wide	Base Width:	17-3/8" outside rails

D1200-3SERIES D-Rung Compact Extension Ladder

225lbs. LOAD CAPACITY

TYPE II
DUTY RATING



Exclusive Alflo® rung joint means Twist-Proof® performance



SPECIFICATIONS

Model No.	Total Length of Sections	Total Length in Storage Position		Max. Working Length	Approx. Cu. Ft. Per Unit	Approx. Shipping Wt. Lbs.
		2 vs. 3 piece*	2 vs. 3 piece*			
D1216-3	18'	8' / 6"	13'	13'	5.9	26.5
D1224-3	27'	12' / 9"	21'	21'	8.7	38.5

* Total Length of ladder in storage position, comparison of Standard 2 - piece vs. New 3 - piece extension ladder.

DIMENSIONS

Rails:	3" wide	Fly Width:	14-1/4" outside rails
Flange:	1-1/16" wide	Base Width:	17-3/8" outside rails
Rungs:	1-3/4"		(20-3/4" to outside of feet)

D1100-2SERIES D-Rung Extension Ladder

200lbs. LOAD CAPACITY

TYPE III
DUTY RATING

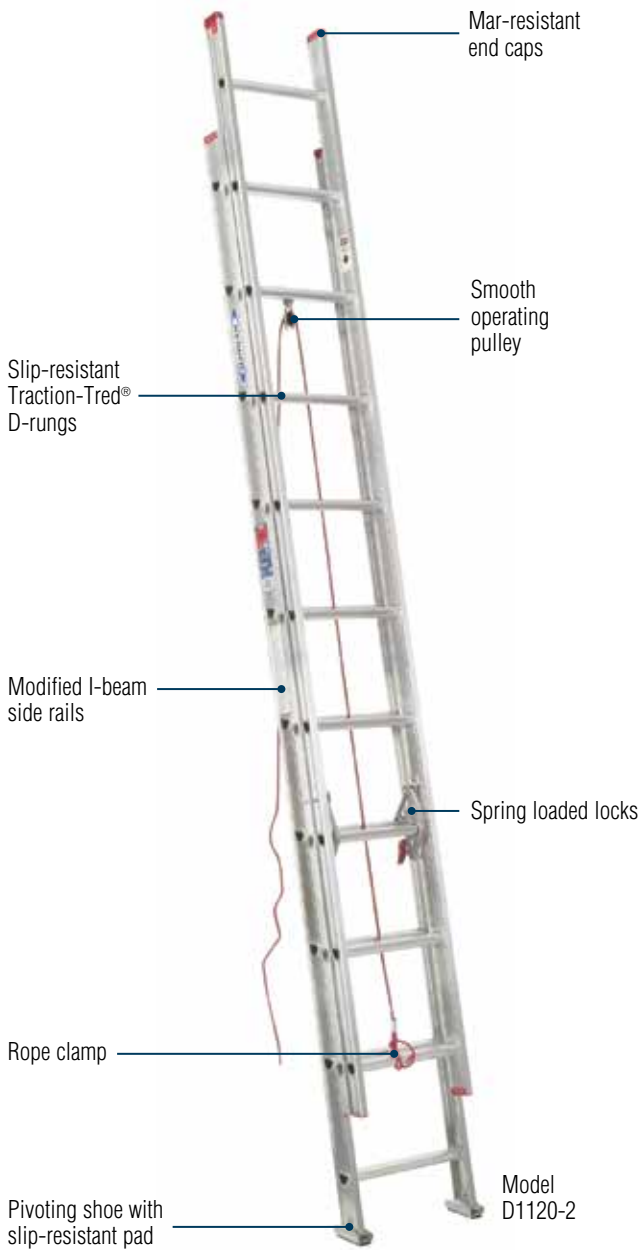

D716-2MODEL D-Rung Extension Ladder

200lbs. LOAD CAPACITY

TYPE III
DUTY RATING

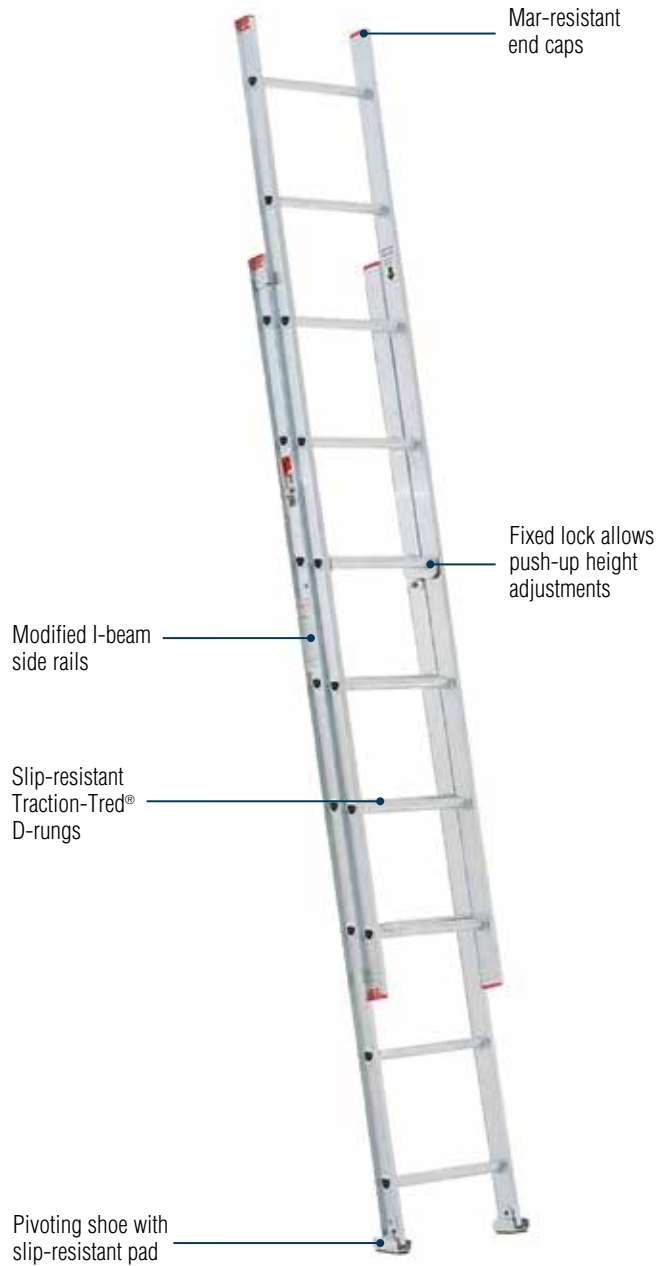

SPECIFICATIONS

Model No.	Total Length of Sections	Max. Working Length	Approx. Cu. Ft. Per Unit	Approx. Shipping Wt. Lbs.
D1116-2‡	16'	13'	4.9	18.5
D1120-2	20'	17'	6.2	23.0
D1124-2	24'	21'	7.4	30.0
D1128-2	28'	25'	9.0	38.5

‡ Note: D1116-2 is not equipped with rope and pulley

DIMENSIONS

Rails:	2-3/4" wide (16' & 20') 3" wide (24' & 28')	Rungs:	1-1/2"
Flange:	15/16" wide	Base Width:	16" outside rails









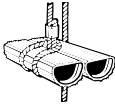

SPECIFICATIONS

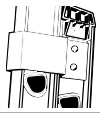
Model No.	Total Length of Sections	Max. Working Length	Approx. Cu. Ft. Per Unit	Approx. Shipping Wt. Lbs.
D716-2	16'	13'	4.6	17.5

DIMENSIONS

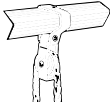
Rails:	2-1/2" wide	Rungs:	1-1/4"
Flange:	3/4" wide	Base Width:	15-3/4" outside rails

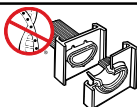
ALUMINUM EXTENSION LADDER COMPARISON CHART

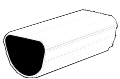
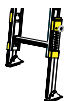
Features and Benefits	D500-2 SERIES	D1500 SERIES	D1800-2EQ SERIES	D1300-2 SERIES	D1700-2EQ SERIES	D1200-2 SERIES	D1100-2 SERIES	D716-2 MODEL
	TYPE IAA/IA	TYPE IA	TYPE I	TYPE I	TYPE II	TYPE II	TYPE III	TYPE III
 Rope clamp ties rope to rung	●	●	●	●	●	●	●	
 Heavy duty shoe with slip-resistant tread and spur plate	●							
Removable sections for use as a single ladder	●	●	●	●	●	●	●	
 External guide brackets		●						
 Pivoting shoe							●	●
 Slip-resistant shoe with Shu-lok® feature and spur plate		●	●	●	●	●		
 Interlocking side rails	●		●	●	●	●	●	
 Rope and pulley system	●	●	●	●	●	●	●	
 Spring loaded locks	●	●	●	●	●	●	●	
 Modified I-beam rails	●	●	●	●	●	●	●	●
 Alflo® rung joint for Twist-Proof® performance	●	●	●	●	●	●	●	●
 Mar-resistant end caps	●	●	●	●	●	●	●	●
 Slip-resistant Traction-Tred® D-rungs	●	●	●	●	●	●	●	●
 Integrated Leveling			●		●			



MTSERIES Telescoping MultiLadder††

300lbs. LOAD CAPACITY PER SIDE

TYPE IA
DUTY RATING

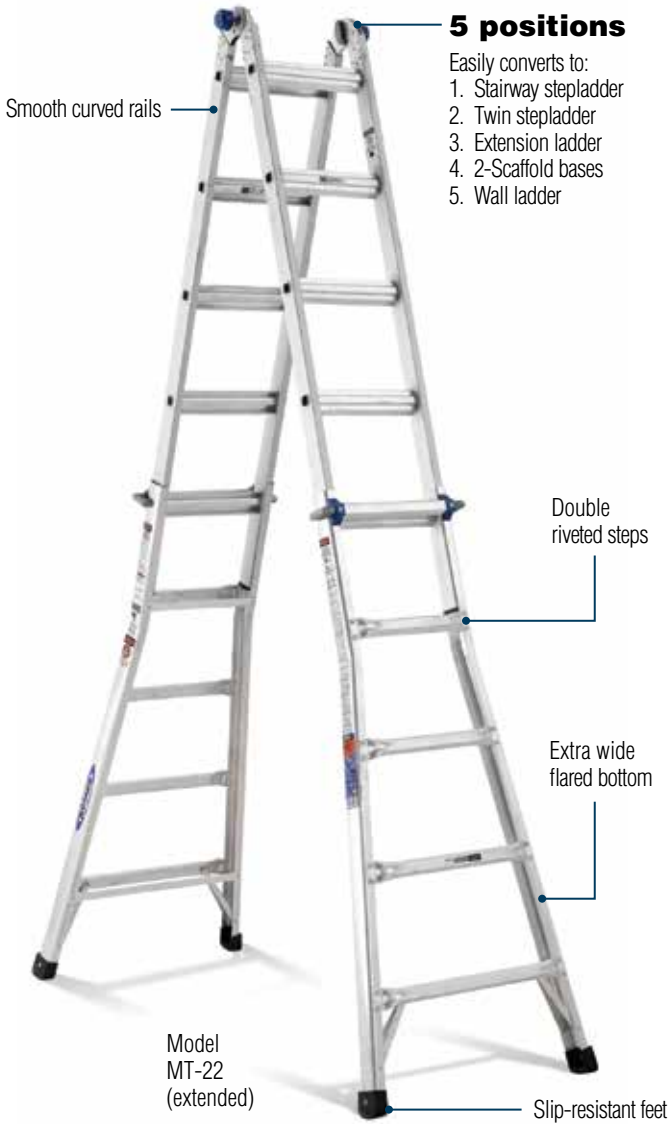

- Telescoping design for maximum versatility

SPECIFICATIONS

Model No.	Stepladder Height	Extension Height	Stair Height	Scaffold Height	Wall Height	Approx. Cu. Ft. Per Unit	Approx. Ship Wt. Lbs.
MT-13	3' to 5'	7' to 11'	3' to 5'	1'-1" to 2'	4' to 5'	5.9	31.5
MT-17	4' to 7'	9' to 15'	4' to 7'	1'-1" to 3'	5' to 7'	6.9	39.5
MT-22	5' to 9'	11' to 19'	5' to 9'	1'-1" to 3'	6' to 9'	10.8	47.0
MT-26	6' to 11'	13' to 23'	6' to 11'	1'-1" to 3'	7' to 11'	12.3	62.6

††Designed for one or two person jobs. Note: When used as a double stepladder, the maximum load per side, including person and materials, shall not exceed the duty rating of ladder.

DIMENSIONS

Rails:	2-5/8" wide	Rungs:	1" wide
Flange:	1" wide		

MIASERIES Folding Multi-Ladder††

300lbs. LOAD CAPACITY PER SIDE

TYPE IA
DUTY RATING



- Shippable by ground parcel services
- Set-up of some positions requires additional equipment, not included.

SPECIFICATIONS

Model No.	Closed Height	Scaffold Height	Stepladder Height	Straight Ladder Length	Approx. Cu. Ft. Per Unit	Approx. Ship Wt. Lbs.
M1A-6-12B	40-5/8"	3'	6'	12'	4.0	33.5
M1A-8-16B	52-5/8"	4'	8'	16'	5.2	39.5

††Designed for one or two person jobs. Note: When used as a double stepladder, the maximum load per side, including person and materials, shall not exceed the duty rating of ladder.

DIMENSIONS

Rails:	2-1/2" wide	Rungs:	1-1/4" multi-directional round type
Flange:	1" wide		

MT1AASERIES Telescoping MultiLadder††

375lbs. LOAD CAPACITY PER SIDE

TYPE IAA
DUTY RATING



- Telescoping design for maximum versatility

SPECIFICATIONS

Model No.	Stepladder Height	Extension Height	Stair Height	Scaffold Height	Approx. Cu. Ft. Per Unit	Approx. Ship Wt. Lbs.
MT1AA-13	3' to 5'	7' to 11'	3' to 5'	1'-1" to 2'	5.9	27.5
MT1AA-17	4' to 7'	9' to 15'	4' to 7'	1'-1" to 3'	6.9	35.1
MT1AA-22	5' to 9'	11' to 19'	5' to 9'	1'-1" to 3'	10.8	45.6

††Designed for one or two person jobs. Note: When used as a double stepladder, the maximum load per side, including person and materials, shall not exceed the duty rating of ladder.

DIMENSIONS

Rails:	2-5/8" wide	Rungs:	1" wide
Flange:	1" wide		

MT MULTI LADDER 5 LADDERS IN 1 MT1AA-22

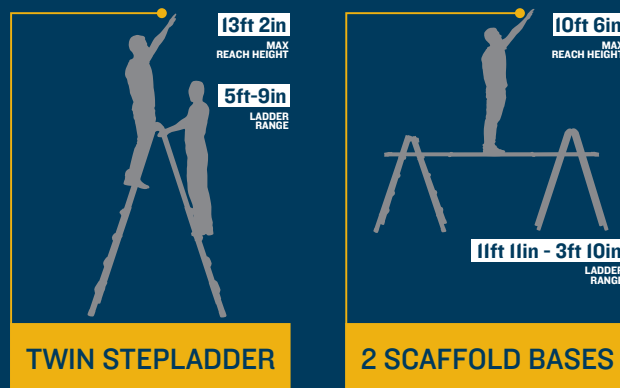

AP-20SERIES Work Platform

225lbs. LOAD CAPACITY

AP-30MODEL Work Platform

300lbs. LOAD CAPACITY



Work comfortably along walls and windows. Ideal for painting.



Multi-use platform

SPECIFICATIONS

Model No.	Height	Width	Depth	Approx. Cu. Ft.	Approx. Shipping Wt. Lbs.
AP-20*	20-9/16"	50-1/4"	15-5/8"	2.1	12.1
AP-20-MP6‡	41"	16-5/8"	35-3/4"	14.1	75.0

* Note: Dimensions of fully open individual unit ‡ Note: Dimensions for packaged unit of 6

DIMENSIONS

Top Deck:	39-1/2" x 12"	Highest Standing Level:	20-9/16"
-----------	---------------	-------------------------	----------

SPECIFICATIONS

Model No.	Height	Width	Depth	Approx. Cu. Ft.	Approx. Shipping Wt. Lbs.
AP-30*	20-9/16"	58-3/4"	19-5/8"	3.3	19.0
AP-30-MP6‡	49-1/2"	20-1/2"	33-7/8"	19.9	120

* Note: Dimensions of fully open individual unit ‡ Note: Dimensions for packaged unit of 6

DIMENSIONS

Top Deck:	48" x 16"	Highest Standing Level:	20-9/16"
-----------	-----------	-------------------------	----------

AP-25MODEL Work Platform

300lbs. LOAD CAPACITY

Large 45in x 12in Pro deck is 12% larger



Platform legs lock securely in place when in use and fold underneath platform for compact storage

Model AP-25

Non-marring feet

AP-35MODEL Work Platform

375lbs. LOAD CAPACITY

Extra-Large 48in x 16in Pro deck



Platform legs lock securely in place when in use and fold underneath platform for compact storage

Model AP-35

Non-marring feet



EASY-GRAB handles make it simple to carry your platform quickly and safely



Link up to four together for up to 16' of continuous work surface

SPECIFICATIONS

Model No.	Height	Width	Depth	Approx. Cu. Ft.	Approx. Shipping Wt. Lbs.
AP-25*	20-1/32"	52-13/32"	15-5/16"	1.5	14.8

* Note: Dimensions of fully open individual unit

DIMENSIONS

Top Deck:	45" x 12"	Highest Standing Level:	20"
-----------	-----------	-------------------------	-----

SPECIFICATIONS

Model No.	Height	Width	Depth	Approx. Cu. Ft.	Approx. Shipping Wt. Lbs.
AP-35*	20-17/32"	54-7/8"	19-15/32"	2.5	22

* Note: Dimensions of fully open individual unit

DIMENSIONS

Top Deck:	48" x 16"	Highest Standing Level:	20"
-----------	-----------	-------------------------	-----

AH SERIES Aluminum Folding Attic Ladder

375lbs. LOAD CAPACITY

STANDARD / EXTRA WIDE OPENINGS

AA MODEL Compact Aluminum Attic Ladder

250lbs. LOAD CAPACITY

BUILT FOR SMALL OPENINGS



Step-by-Step Installation Made Easy

Online Video

werneratticladders.com



Step-by-Step Installation Made Easy

Online Video

werneratticladders.com

- Lightweight – easy to open, close and install
- Attractive – will not splinter, decay or rust

SPECIFICATIONS

Model No.	Rough Opening Width x Length	Floor to Ceiling Height Range	Approx. Ladder Width	Approx. Cu. Ft. Per Unit	Approx. Shipping Wt. Lbs.
AH2210	22-1/2" x 54"	7'8" to 10'3"	14-1/8"	6.8	48.5
AH2510	25" x 54"	7'8" to 10'3"	17-1/8"	7.6	52.0
AH2512	25" x 66"	10'5" to 12'	17-1/8"	9.2	58.5

DIMENSIONS

Rails:	2-3/8" wide	Steps:	3" wide
Flange:	1-1/2" wide		



Hallways

Garages

Tight Spaces

SPECIFICATIONS

Model No.	Rough Opening Width x Length	Floor to Floor Height Range	Approx. Ladder Width	Approx. Cu. Ft. Per Unit	Approx. Shipping Wt. Lbs.
AA1510	18" x 24" Minimum	7' to 9'10"	12-1/8"	2.55	15.5

DIMENSIONS

Rails:	5/8" x 2-1/8" wide	Steps:	1-3/16" wide
--------	--------------------	--------	--------------

WHSERIES Wood Folding Heavy Duty Attic Ladder

350lbs. LOAD CAPACITY

STANDARD / EXTRA WIDE OPENINGS

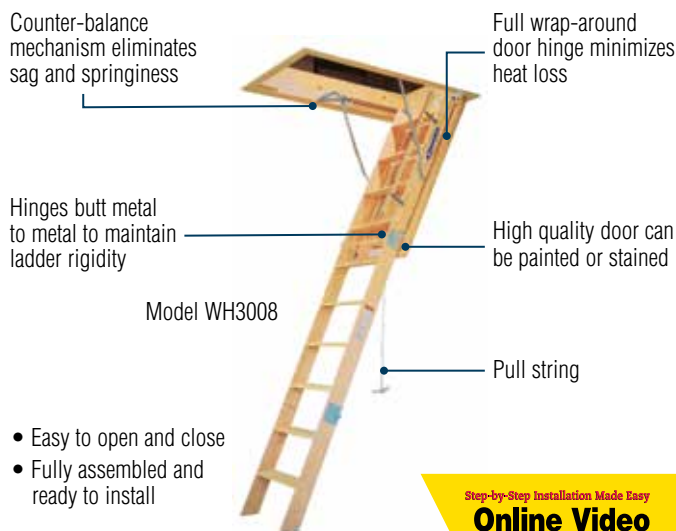

Step-by-Step Installation Made Easy

Online Video

werneratticladders.com

SPECIFICATIONS

Model No.	Rough Opening Width x Length	Floor to Ceiling Height Range	Approx. Ladder Width	Approx. Cu. Ft. Per Unit	Approx. Shipping Wt. Lbs.
WH2208	22-1/2" x 54"	7' to 8'9"	14-1/4"	10.55	59.5
WH2210	22-1/2" x 54"	8'9" to 10'3"	14-1/4"	10.55	64.5
WH2508	25" x 54"	7' to 8'9"	16-3/4"	11.96	62.5
WH2510	25" x 54"	8'9" to 10'3"	16-3/4"	11.96	67.5
WH3008	30-1/2" x 54"	7' to 8'9"	22 1/4"	14.30	73.5
WH3010	30-1/2" x 54"	8'9" to 10'3"	22 1/4"	14.30	76.5

NOMINAL DIMENSIONS

	Actual Lumber Size	Rough Lumber Size
Rails:	3/4" x 4-1/2"	1" x 5"
Grooved Steps:	3/4" x 4-1/2"	1" x 5"

WSERIES Wood Folding Attic Ladder

250lbs. LOAD CAPACITY

STANDARD / EXTRA WIDE OPENINGS



Step-by-Step Installation Made Easy

Online Video

werneratticladders.com

SPECIFICATIONS

Model No.	Rough Opening Width x Length	Floor to Ceiling Height Range	Approx. Ladder Width	Approx. Cu. Ft. Per Unit	Approx. Shipping Wt. Lbs.
W2208	22 1/2" x 54"	7' to 8'9"	14-1/4"	8.61	48.6
W2210	22 1/2" x 54"	8'9" to 10'4"	14-1/4"	8.61	51.3
W2508	25" x 54"	7' to 8'9"	16-3/4"	9.76	51.2
W2510	25" x 54"	8'9" to 10'4"	16-3/4"	9.76	53.9

NOMINAL DIMENSIONS

	Actual Lumber Size	Rough Lumber Size
Rails:	3/4" x 3-1/2"	1" x 4"
Grooved Steps:	3/4" x 3-1/2"	1" x 4"

ATTIC LADDER COMPARISON CHART

Product Advantages	AHSERIES	AA SERIES	WHSERIES	WSERIES
Material	Aluminum	Aluminum	Wood	Wood
Style	Folding	Sliding	Folding	Folding
Size	8 ft., 10 ft., 12 ft.	7' - 9' 10"	8 ft., 10 ft.	8 ft., 10 ft.
Load Capacity	375 lbs.	250 lbs.	350 lbs.	250 lbs.
Ceiling Height Range	7' to 12'	7' to 9'10" (floor to floor)	7' to 10' 3"	7' to 10' 4"
Locking Device	Gas Strut	N/A	Spring	Spring
Opening Device	Rope	Push/Pull Rod	Rope	Rope
Door Material	Plywood	Not Included (Door hardware included)	Plywood	Plywood
Frame Material	Pine	N/A	Pine	Pine
Full Width Door Hinge	Yes	N/A	Yes	Yes
Metal-to-Metal Rail Hinge	Yes	N/A	Yes	Yes
Requires Cutting Rail	Yes	No	Yes	Yes
Separate Foot Attachment	Yes	No	No	No
Number of People for Installation	Two	One	Two	Two
Step Depth	3"	1-3/16"	4-1/2"	3-1/2"
Finished Rails with Eased Edges	2-3/8" wide	2-1/8" wide	4-1/2" wide	3-1/2" wide
Approximate Shipping Weight	48-58 lbs.	15.5 lbs.	59-76 lbs.	48-54 lbs.

PS-48MODEL Portable Scaffold

500lbs. LOAD CAPACITY*

MULTIPLE WORKING HEIGHTS



Mar-resistant wheels
High grade wheels prevent marring by locking securely into place



Multi-use S-Hooks make transportation easy and are ToolLasso® ready



Extra wide 10" plank for secure standing and comfort

- Versatile; can be used as push cart, storage shelf or work bench
- *250 lbs. per plank (500 lbs. combined)

SPECIFICATIONS

Model No.	Height	Width	Depth	Approx. Cu. Ft Per Packaged Unit	Approx. Shipping Wt. Lbs.
PS-48	50-1/8"	46-1/8"	25-1/2"	3.4	60.0

PLANK DIMENSIONS

	Length	Width
Narrow Plank	46"	6"
Wide Plank	46"	10"

SRS-72MODEL 6' Steel Rolling Scaffold

1000lbs. LOAD CAPACITY*



Deck pins secure plywood to scaffold frame

Sections stack easily when casters are removed (2 high maximum)

Platform height adjustable in 2" increments for unique working heights and uneven surfaces

Protected locking pins prevent accidental release

Locking casters swivel for convenient 360° mobility



Deck with Trap Door SRS-72T Model

- Easy one-person assembly- No tools required for quick setup and tear down.
- *1000 lbs. load capacity distributed evenly

DIMENSIONS

Model No.	Approx. Width	Approx. Length	Approx. Height	Approx. Shipping Wt. Lbs.
SRS-72	29-1/2"	73-3/4"	74-7/8"	127
SRS-72T	29-1/2"	73-3/4"	74-7/8"	130

COMPONENT DIMENSIONS

Component	Quantity Included	Approx. Width	Approx. Length	Approx. Height
Frames	2	29"	68-3/4"	1-1/2"
Arm Braces	2	1-1/2"	73-7/8"	17-7/8"
Plywood Deck	1	28-1/2"	66-3/4"	1-1/2"
Locking Casters	4	5-1/8"	9-7/8"	—

ACCESSORIES (AVAILABLE SEPARATELY)

Model No.	Description	Approx. Width	Approx. Length	Approx. Height	Approx. Shipping Wt. Lbs.
SRO-72-4	Outriggers (4-pc master carton)	18"	20-3/4"	—	37.5
SRO24-72-4	Outriggers (4-pc master carton)	18"	24"	—	38
SRG-72	Guard Rail and Toeboard Kit	28-7/8"	69-5/8"	42"	70.5
SRC-72-4	Casters (4-pc master carton)	5-1/8"	1-1/8"	9-7/8"	20.0
SRD-72	Plywood Deck	28-1/2"	66-3/4"	2"	32.5
SRD-72T	Plywood Deck with Trap Door	28-1/2"	66-3/4"	2"	35.5

Note: Outriggers and Guard Rails are required when working height reaches 10'

PA200SERIES Aluminum Extension Plank

- 1 person, 250 lb. Load Capacity.
- For use on stepladders, telescoping multiladders, extension trestle ladders and extension and single ladders equipped with ladder jacks.

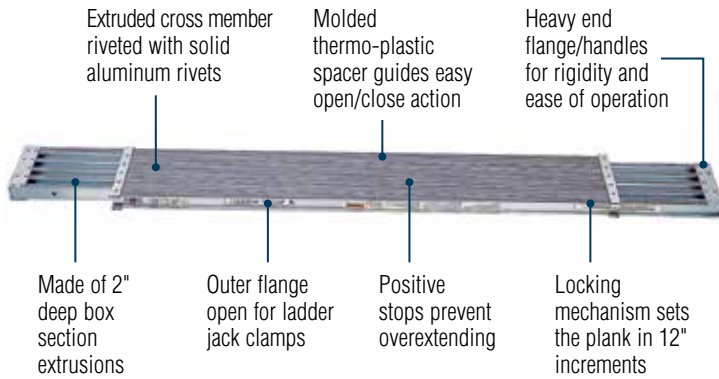

SPECIFICATIONS

Model No.	Closed Position	Open Position	Approx. Width	Inner Rails	Outer Flanged Rails	Approx. Cu. Ft. Per Unit	Approx. Shipping Wt. Lbs.
PA206	6'	9'	14"	1-1/8" x 2"	1-7/8" x 2"	1.5	31.0
PA208	8'	13'	14"	1-1/8" x 2"	1-7/8" x 2"	2.0	40.5
PA210	10'	17'	14"	1-1/8" x 2"	1-7/8" x 2"	2.5	56.5

Note: When assembled as scaffold or staging, these planks must be used in conjunction with suitable guard rail protection in compliance with applicable governmental codes, ordinances, regulations and safe practice.

5600SERIES 2-Piece Extruded Aluma-Board™



SPECIFICATIONS

Model No.	Duty Rating/Sq. Ft.	Width	Side Rail Length	Side Rail Depth	Approx. Shipping Wt. Lbs.
5607-19	75 lbs.	19-1/16"	7'	2"	30.0

FOR USE WITH STEEL SCAFFOLDS

5500SERIES Aluminum Decked Aluma-Plank®



SPECIFICATIONS

Model No.	Duty Rating/Sq. Ft.	Width	Side Rail Length	Side Rail Depth	Approx. Shipping Wt. Lbs.
5507-19	75 lbs.	19-1/16"	7'	3"	25.0
5508-19	75 lbs.	19-1/16"	8'	4"	34.0
5510-19	75 lbs.	19-1/16"	10'	4"	43.0

FOR USE WITH STEEL SCAFFOLDS

5300SERIES Plywood Decked Aluma-Plank®



SPECIFICATIONS

Model No.	Duty Rating/Sq. Ft.	Width	Side Rail Length	Side Rail Depth	Approx. Shipping Wt. Lbs.
5307-19	75 lbs.	19-1/16"	7'	3-1/2"	27.0
5308-19	75 lbs.	19-1/16"	8'	4-1/2"	38.0
5310-19	75 lbs.	19-1/16"	10'	4-1/2"	47.0
5307-24	75 lbs.	24"	7'	4"	32.0
5310-24	75 lbs.	24"	10'	4-1/2"	53.0

FOR USE WITH STEEL SCAFFOLDS

ALUMINUMPUMP JACK SYSTEM

- Versatile, dependable and easy to operate
- Field replaceable components
- Compatible and interchangeable with the leading competitor



Note: When working 10 ft. and above, OSHA requires fall protection. Refer to product labels.

- 1** Foldable Support
Brace (PJ-SBF)
- 2** Nestable Stage
(WNS 2512)
- 3** Safety Net
(PJ-SN)
- 4** Work Bench
(PJ-WB)
- 5** Pump Jack
(PJ-100)
- 6** End Rail Kit
(narrow) (PJ-ERN)
- 7** 24' Aluminum Pole
(PJ-24P)

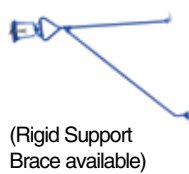

Also available:
6' (PJ-6P)
12' (PJ-12P)
18' (PJ-18P)

- Pump Jack
- Work Bench
- Poles and Brace
- End Rail Kits
- Safety Net



Nestable Stages



- Continuous work platform reduces trip hazard
- 2 Person – 500 lbs. Rated

PUMP JACK COMPONENTS

Model No.	Description	Approx. Shipping Wt. Lbs.
PJ-100	Pump jack	30.0
PJ-PF-4	Pole foot	3.0
PJ-6P	6' aluminum pole	14.0
PJ-12P	12' aluminum pole	28.0
PJ-18P	18' aluminum pole	42.0
PJ-24P	24' aluminum pole	56.0
PJ-PC	Pole connector	12.0
PJ-SBF	Foldable support brace	9.0
PJ-SBR	Rigid support brace	14.0
PJ-WB	Work bench	15.0
PJ-ERN	End rail kit (narrow)	15.0
PJ-ERW	End rail kit (wide)	17.0
PJ-SN	Safety net	14.0

NESTABLE STAGES

Model No.	Nestable Stage Description	Approx. Shipping Wt. Lbs.
WNS-2412	14" x 12'	46.0
WNS-2416	14" x 16'	63.0
WNS-2420	14" x 20'	86.0
WNS-2424	14" x 24'	115.0
WNS-2512	20" x 12'	54.0
WNS-2516	20" x 16'	75.0
WNS-2520	20" x 20'	103.0
WNS-2524	20" x 24'	122.0
WNS-2612	24" x 12'	62.0
WNS-2616	24" x 16'	81.0
WNS-2620	24" x 20'	116.0
WNS-2624	24" x 24'	139.0

STEELPUMP JACK SYSTEM

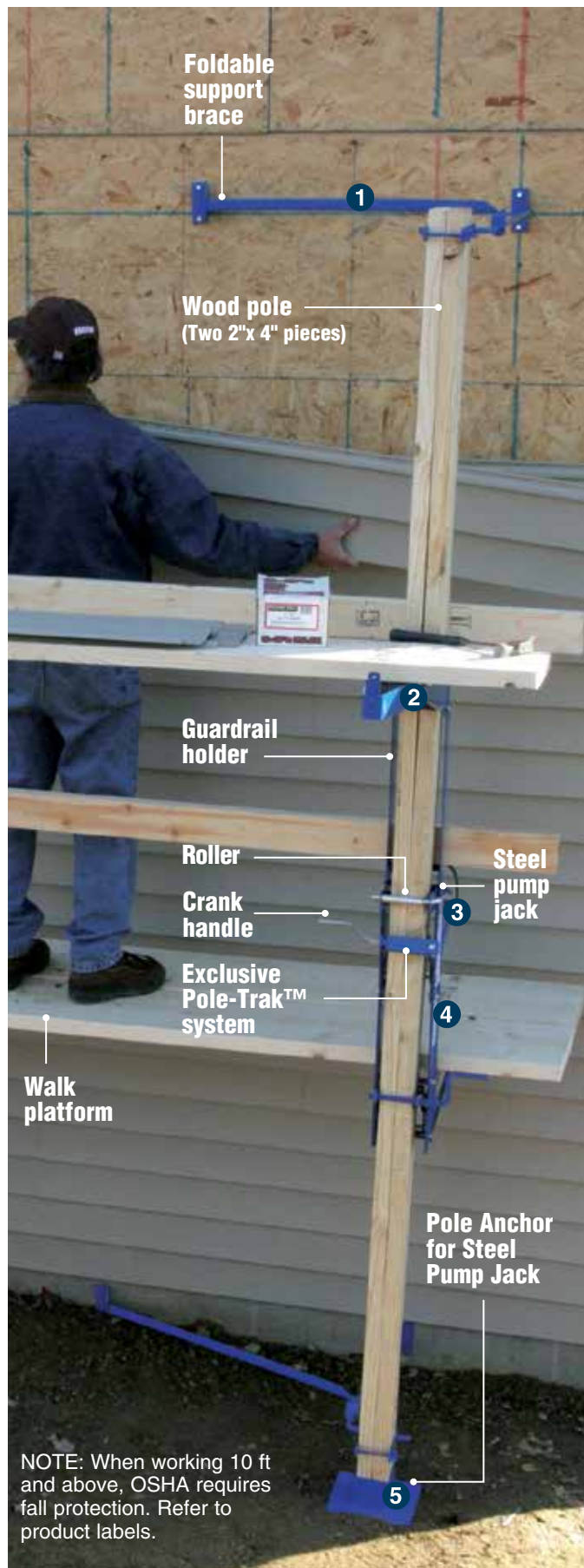

- Exclusive Pole-Trak™ system with rugged hand crank and safety brake
- Slip-resistant foot lever with oversized boot strap
- Accommodates up to a 24" wide plank
- Economical and easy to operate
- Meets ANSI and OSHA standards

- **Pump Jack**
- **Work Bench with Guard Rail Holder**
- **Pole Anchor**
- **Foldable Brace**

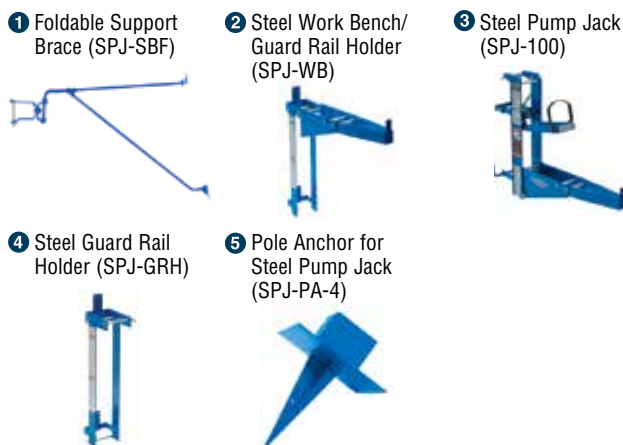

COMPONENTS SHOWN

Description	Model Number	Product Weight (lbs)
1 Foldable Support Brace	SPJ-SBF	7.0
2 Steel Work Bench/ Guard Rail Holder	SPJ-WB	11.0
3 Steel Pump Jack	SPJ-100	23.0
4 Steel Guard Rail Holder	SPJ-GRH	5.5
5 Pole Anchor for Steel Pump Jack (Shipped in 4-packs)	SPJ-PA-4	5.5 (4-pk weight: 23.0)

ALUMINUM TASK MASTER® STAGES

- **Twist-Proof® Stage Design**
- **Ideal for ladder jack applications, swing stages or catwalks**

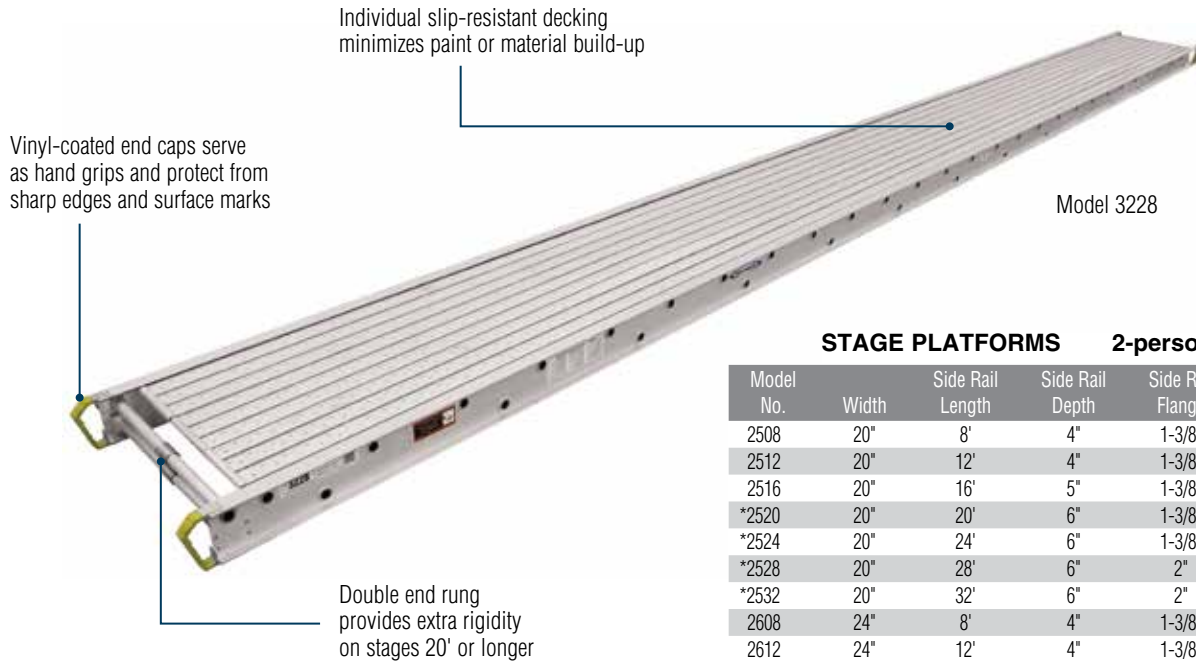

STAGE PLATFORMS 2-person - 500 lbs. rated

Model No.	Width	Side Rail Length	Side Rail Depth	Side Rail Flange	Approx. Shipping Wt. Lbs.
2508	20"	8'	4"	1-3/8"	33.0
2512	20"	12'	4"	1-3/8"	48.0
2516	20"	16'	5"	1-3/8"	70.0
*2520	20"	20'	6"	1-3/8"	102.0
*2524	20"	24'	6"	1-3/8"	121.0
*2528	20"	28'	6"	2"	157.0
*2532	20"	32'	6"	2"	179.0
2608	24"	8'	4"	1-3/8"	38.0
2612	24"	12'	4"	1-3/8"	56.0
2616	24"	16'	5"	1-3/8"	81.0
*2620	24"	20'	6"	1-3/8"	115.0
*2624	24"	24'	6"	1-3/8"	138.0
*2628	24"	28'	6"	2"	168.0
*2632	24"	32'	6"	2"	191.0
2708	28"	8'	4"	1-3/8"	41.0
2712	28"	12'	4"	1-3/8"	60.0
2716	28"	16'	5"	1-3/8"	87.0
*2720	28"	20'	6"	1-3/8"	124.0
*2724	28"	24'	6"	1-3/8"	147.0
*2728	28"	28'	6"	2"	187.0
*2732	28"	32'	6"	2"	213.0

DECORATOR PLANKS 1-person - 250 lbs. rated

Model No.	Width	Side Rail Length	Side Rail Depth	Side Rail Flange	Approx. Shipping Wt. Lbs.
2008	12"	8'	4"	1-3/8"	25.0
2012	12"	12'	4"	1-3/8"	36.0
2016	12"	16'	4"	1-3/8"	48.0
2020	12"	20'	5"	1-3/8"	65.0
2024	12"	24'	5"	1-3/8"	78.0

SCAFFOLD PLANKS 2-person - 500 lbs. rated

Model No.	Width	Side Rail Length	Side Rail Depth	Side Rail Flange	Approx. Shipping Wt. Lbs.
2316	12"	16'	4"	1-3/8"	48.0
2320	12"	20'	6"	1-3/8"	79.0
2324	12"	24'	6" Heavy Duty	1-3/8"	112.0
2328	12"	28'	6" Heavy Duty	1-3/8"	131.0
2330	12"	30'	6" Heavy Duty	1-3/8"	140.0
2332	12"	32'	6" Heavy Duty	1-3/8"	149.0
2408	14"	8'	4"	1-3/8"	27.0
2412	14"	12'	4"	1-3/8"	40.0
2416	14"	16'	5"	1-3/8"	58.0
2420	14"	20'	6"	1-3/8"	85.0
2424	14"	24'	6"	2"	109.0
2428	14"	28'	6"	2"	127.0
2432	14"	32'	6" Heavy Duty	2"	182.0

3-person - 750 lbs. rated

3112	24"	12'	4"	2"	64.0
3116	24"	16'	5"	2"	92.0
*3120	24"	20'	5"	2"	115.0
*3124	24"	24'	6"	2"	145.0
*3128	24"	28'	6" Heavy Duty	2"	204.0
*3132	24"	32'	6" Heavy Duty	2"	236.0
*3136	24"	36'	6" Heavy Duty	2"	323.0
*3139	24"	39'	6" Heavy Duty	2"	365.0
3208	28"	8'	4"	2"	48.0
3212	28"	12'	4"	2"	71.0
3216	28"	16'	5"	2"	103.0
*3220	28"	20'	5"	2"	128.0
*3224	28"	24'	6"	2"	161.0
*3228	28"	28'	6" Heavy Duty	2"	220.0
*3232	28"	32'	6" Heavy Duty	2"	251.0
*3236†	28"	36'	6" Heavy Duty	2"	344.0
*3239†	28"	39'	6" Heavy Duty	2"	388.0

*Includes set of double rungs at the end of stage. †Includes reinforcing channel

GUARD RAIL SYSTEMS

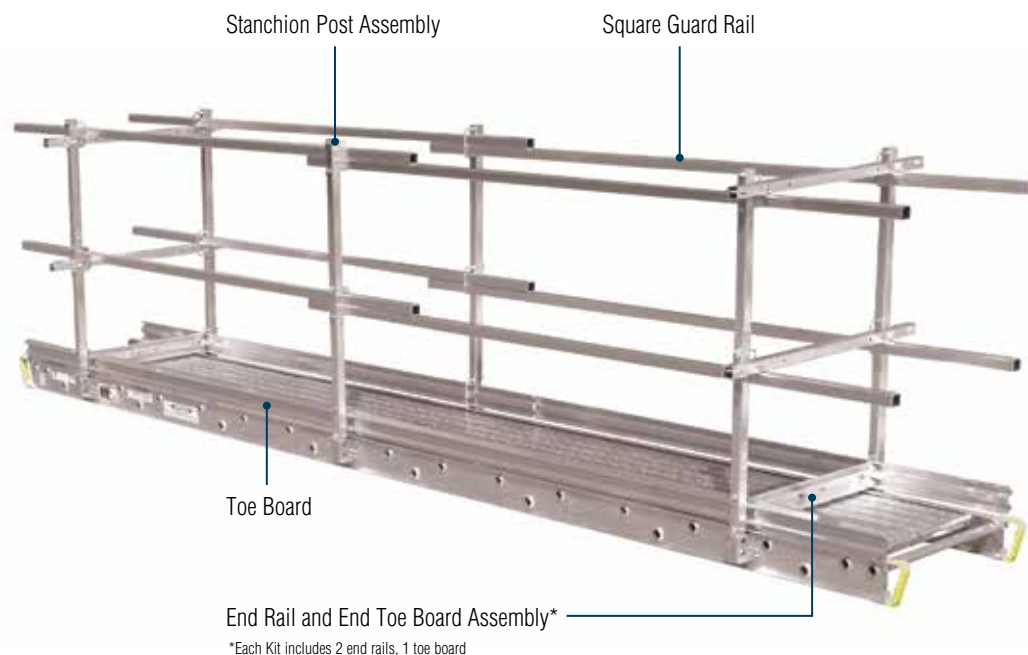

SQUARE MODULAR GUARD RAIL SYSTEM

System Sizing: How do I size a guard rail system?

The following steps show how to size a single-sided, three-sided, and four-sided guard rail system:

- Step 1: Determine the stage length and width.
- Step 2: Determine whether guardrail system is one-, two-, three-, or four -sided.
- Step 3: Read across the row to determine component requirements.
- Step 4: If ordering a three- or four-sided system, order two ERT-N for 12" and 14" wide stages, and two ERT-W for all stages 20" wide or greater.

Note: If ordering a two sided system, double the single sided component requirement.

Model No.	Description	Approx. Shipping Wt. Lbs.
ERT-N	End rail and end toe board assembly - narrow	4.5
ERT-W	End rail and end toe board assembly - wide	7.0
SSP-47	Stanchion post assembly	5.0
SGR-09	1-1/2" square guard rail cut length - 108"	6.0
SGR-13	1-1/2" square guard rail cut length - 156"	8.5
STB-09	3-1/2" toe board cut length - 108"	4.5
STB-13	3-1/2" toe board cut length - 156"	6.5

Stage Length	Single-sided					Three-sided					Four-sided						
	SSP-47	SGR-09	SGR-13	STB-09	STB-13	SSP-47	SGR-09	SGR-13	STB-09	STB-13	ERT-N/ ERT-W*	SSP-47	SGR-09	SGR-13	STB-09	STB-13	ERT-N/ ERT-W*
8'	2	2	0	1	0	4	2	0	1	0	2	4	4	0	2	0	2
12'	3	0	2	0	1	5	0	2	0	1	2	6	0	4	0	2	2
16'	3	4	0	2	0	5	4	0	2	0	2	6	8	0	4	0	2
20'	4	2	2	1	1	6	2	2	1	1	2	8	4	4	2	2	2
24'	5	4	2	2	1	7	4	2	2	1	2	10	8	4	4	2	2
28'	6	2	4	1	2	8	2	4	1	2	2	12	4	8	2	4	2
32'	6	2	4	1	2	8	2	4	1	2	2	12	4	8	2	4	2
36'	6	10	0	5	0	8	10	0	5	0	2	12	20	0	10	0	2
39'	7	4	4	2	2	9	4	4	2	2	2	14	8	8	4	4	2

*ERT-N is for 12" and 14" wide stages; ERT-W is for 20" wide and greater stages

ALUMINUM SCAFFOLDING

Werner aluminum scaffolding is best suited for construction and building maintenance applications, especially in high-traffic areas where mobility and appearance are important.

CONSTRUCTION:

- Drywall
- Insulation
- Drop ceilings
- Ductwork

BUILDING MAINTENANCE:

- Window and façade cleaning
- Changing light bulbs
- Painting
- Wallpapering

Aluminum scaffolding has benefits that steel scaffolding does not.

- More corrosion resistant
- Convenient - 30-50% lighter
- Easier and quicker to install
- Better on-site appearance

Werner offers scaffolding as towers, sections and individual components.

- Towers and sections for the one-time purchaser with limited scaffold knowledge
- Components for the regular purchaser with extensive knowledge on configuring a scaffold tower

Scaffolding can be used on inclines and stairs.

- For use on an incline, a scaffold tower must be secured to prevent movement.
- Scaffolding can be used on a stairway provided the horizontal braces from one end frame to the other are at the same level and adequate braces are used.

ALUMINUM SCAFFOLD TOWERS

- Easy and convenient to order
- Takes the guesswork out of what is required to meet Code
- Ideal for schools, hospitals and building maintenance

Includes guard rails, toeboards and planks with access door that allows end users to climb from inside. 23' towers include additional fixed board (no access door). Outriggers included on all models except 4201-12, 4202-12 and 4203-12. These models meet the ANSI code as noted on Page 50 - "Notice".

Narrow Span Towers

Platform Length	Total Width (W)	Total Length (L)
6'	9' 6"	9' 6"
8'	9' 6"	11' 6"
10'	9' 6"	13' 6"



12' Platform Height

Model No.	Platform Length	Platform Width	Platform Height	Total Tower Height	Approx. Shipping Wt. Lbs.
4101-12	6'	29"	12'	15' 5"	359.0
4102-12	8'	29"	12'	15' 5"	389.0
4103-12	10'	29"	12'	15' 5"	410.5

Wide Span Towers



12' Platform Height*

Model No.	Platform Length	Platform Width	Platform Height	Total Tower Height	Approx. Shipping Wt. Lbs.
4201-12	6'	4-1/2'	12'	15' 5"	299.5
4202-12	8'	4-1/2'	12'	15' 5"	338.0
4203-12	10'	4-1/2'	12'	15' 5"	366.0

*Outriggers not included with 12' high platform wide span towers (Per ANSI code, does not require outriggers).



18' Platform Height

Model No.	Platform Length	Platform Width	Platform Height	Total Tower Height	Approx. Shipping Wt. Lbs.
4101-18	6'	29"	17' 6"	20' 11"	405.0
4102-18	8'	29"	17' 6"	20' 11"	439.0
4103-18	10'	29"	17' 6"	20' 11"	462.5

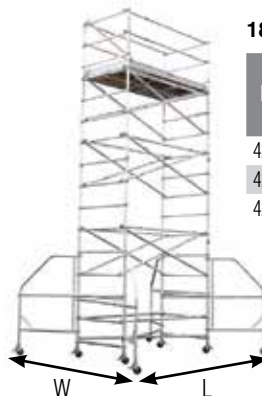

18' Platform Height

Model No.	Platform Length	Platform Width	Platform Height	Total Tower Height	Approx. Shipping Wt. Lbs.
4201-18	6'	4-1/2'	17' 6"	20' 11"	561.5
4202-18	8'	4-1/2'	17' 6"	20' 11"	610.0
4203-18	10'	4-1/2'	17' 6"	20' 11"	643.0

Platform Length	Total Width (W)	Total Length (L)
6'	10' 10"	10' 10"
8'	10' 10"	12' 10"
10'	10' 10"	14' 7"



23' Platform Height

Model No.	Platform Length	Platform Width	Platform Height	Total Tower Height	Approx. Shipping Wt. Lbs.
4101-23	6'	29"	23'	26' 4"	451.0
4102-23	8'	29"	23'	26' 4"	489.0
4103-23	10'	29"	23'	26' 4"	514.5

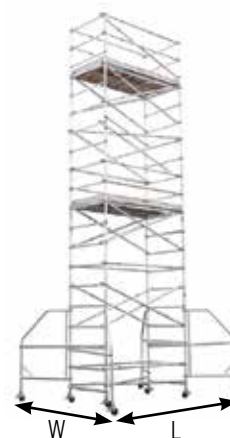

23' Platform Height

Model No.	Platform Length	Platform Width	Platform Height	Total Tower Height	Approx. Shipping Wt. Lbs.
4201-23	6'	4-1/2'	23'	26' 4"	695.0
4202-23	8'	4-1/2'	23'	26' 4"	778.0
4203-23	10'	4-1/2'	23'	26' 4"	862.0

Platform Length	Total Width (W)	Total Length (L)
6'	10' 10"	10' 10"
8'	10' 10"	12' 10"
10'	10' 10"	14' 7"

Load Capacity: 25 lbs. per sq. ft. or 500 lbs. maximum per deck & scaffold.

Load Capacity: 25 lbs. per sq. ft. or 500 lbs. per deck and 1,000 lbs. maximum per scaffold.

SCAFFOLD SECTIONS

- Easy and convenient to order
- Enables user to easily add to an existing scaffold tower
- Ideal for painting and remodeling contractors

NARROW SPAN SCAFFOLD SECTIONS

Load Capacity: 25 lbs. per sq. ft. or 500 lbs. maximum per deck and scaffold

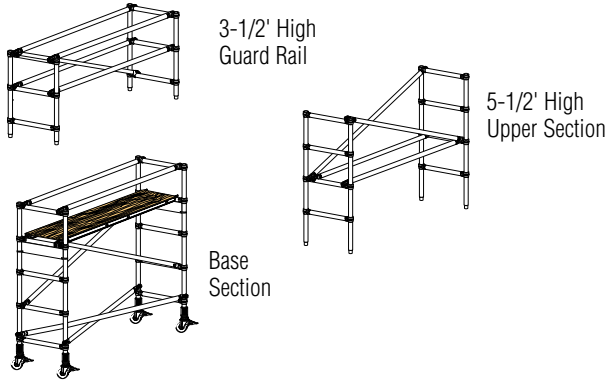

Model No.	Width	Length	Approx. Shipping Wt. Lbs.
6' 6" to 7' 6" High Adjustable Base Sections			
4101	29"	6'	121.0
4102	29"	8'	133.0
4103	29"	10'	145.0
6-3/4' High Upper Sections			
4127	29"	6'	60.0
4128	29"	8'	65.0
4129	29"	10'	68.0
5-1/2' High Upper Sections			
4104	29"	6'	53.0
4105	29"	8'	58.0
4106	29"	10'	62.0
4' High Upper Sections			
4107	29"	6'	47.0
4108	29"	8'	51.0
4109	29"	10'	55.0
3-1/2' High Guard Rails			
4110	29"	6'	44.0
4111	29"	8'	48.0
4112	29"	10'	52.0

SNAP-UP® NARROW SPAN FOLDING SCAFFOLDS

Load Capacity: 25 lbs. per sq. ft. or 500 lbs. maximum per deck and scaffold

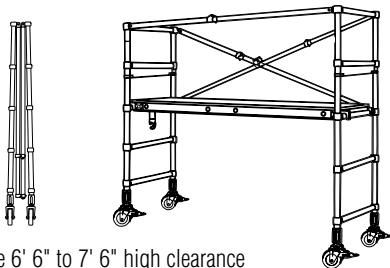

- Adjustable 6' 6" to 7' 6" high clearance

Model No.	Width	Length	Approx. Shipping Wt. Lbs.
SNB-6U	29"	6'	127.0
SNB-8U	29"	8'	139.0

WIDE SPAN SCAFFOLD SECTIONS

Load Capacity: 25 lbs. per sq. ft. or 500 lbs. maximum per deck and 1000 lbs. maximum per scaffold

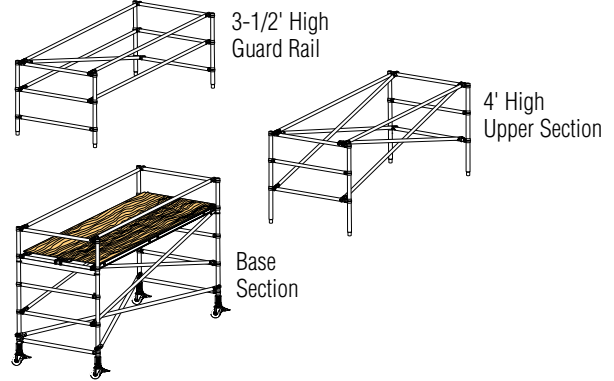

Model No.	Width	Length	Approx. Shipping Wt. Lbs.
6' 6" to 7' 6" High Base Sections			
4201	4-1/2'	6'	167.0
4202	4-1/2'	8'	188.0
4203	4-1/2'	10'	208.0
5-1/2' High Upper Sections			
4204	4-1/2'	6'	71.0
4205	4-1/2'	8'	76.0
4206	4-1/2'	10'	81.0
4' High Upper Sections			
4207	4-1/2'	6'	62.0
4208	4-1/2'	8'	68.0
4209	4-1/2'	10'	73.0
3-1/2' High Guard Rails			
4210	4-1/2'	6'	55.0
4211	4-1/2'	8'	60.0
4212	4-1/2'	10'	65.0

SNAP-UP® WIDE SPAN FOLDING SCAFFOLDS

Load Capacity: 25 lbs. per sq. ft. or 500 lbs. maximum per deck and 1000 lbs. maximum per scaffold

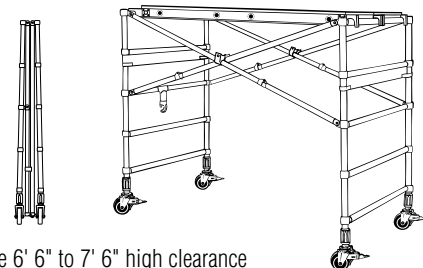

- Adjustable 6' 6" to 7' 6" high clearance

Model No.	Width	Length	Approx. Shipping Wt. Lbs.
SWB-6U	4-1/2'	6'	163.0
SWB-8U	4-1/2'	8'	181.0

SCAFFOLD COMPONENTS

- Provides most flexibility during installation
- Enables end user to easily convert to different length or height scaffold towers
- All components available separately
- Ideal for rental yards and theatrical and entertainment applications.

FRAMES

Model No.	Description	Approx. Shipping Wt. Lbs.
For Narrow Span, 29" Wide		
FNB-80	Base end frame	35.0
FNU-81	6-3/4' H upper end frame	19.0
FNU-65	5-1/2' H upper end frame	15.0
FNU-49	4' H upper end frame	12.0
FNG-42	Guard rail end frame	11.5
For Wide Span, 4-1/2' Wide		
FWB-80	Base end frame	39.5
FWU-81	6-3/4' H wide span upper end frame	22.0
FWU-65	5-1/2' H upper end frame	19.0
FWU-49	4' H upper end frame	14.5
FWG-42	Guard rail end frame	14.5

SCAFFOLD BOARDS

Model No.	Description	Approx. Shipping Wt. Lbs.
P22W-6	6' scaffold board	28.5
P22W-8	8' scaffold board	36.0
P22W-10	10' scaffold board	42.5
PD22W-6	22" wood deck with access door - 6' board	33.0
PD22W-8	22" wood deck with access door - 8' board	41.0
PD22W-10	22" wood deck with access door - 10' board	49.0

BRACES

Model No.	Description	Approx. Shipping Wt. Lbs.
BD-6	6' diagonal brace	4.0
BD-8	8' diagonal brace	5.0
BD-10	10' diagonal brace	5.5
BH-6	6' horizontal brace	4.0
BH-8	8' horizontal brace	5.0
BH-10	10' horizontal brace	5.5
BN-6	6' narrow span horizontal-diagonal brace	4.0
BN-8	8' narrow span horizontal-diagonal brace	5.0
BN-10	10' narrow span horizontal-diagonal brace	6.0
BW-6	6' wide span horizontal-diagonal brace	5.0
BW-8	8' wide span horizontal-diagonal brace	5.5
BW-10	10' wide span horizontal-diagonal brace	6.0

ACCESSORY KITS

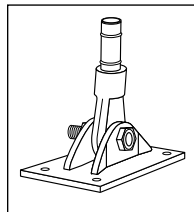

**Kit No. 41-1
ONE SWIVEL
BASE
PLATE**

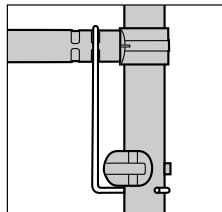

**Kit No. 43-1
GUARD RAIL HOLDER**

A Werner Exclusive

Includes four steel guard rails holders. With a set of guard rail holders, you can easily turn a horizontal brace into a guard rail.

NOTE: Guard Rail Holder fits Intermediate Scaffold Section Models: 4104-4109, 4127-4129, 4204-4209. They are not designed for Werner Co. Guard Rail Upper Section Models: 4110, 4111, 4112, 4210, 4211, 4212.

Kit No.	Description	Approx. Shipping Wt. Lbs.
41-1	One swivel base plate for stairway and span type scaffolds	8.0
43-1	Guard Rail Holder fits intermediate scaffold section models: 4104-4109, 4127-4129, 4204-4209.	1.2

OUTRIGGERS for Wide and Narrow Span Scaffolds

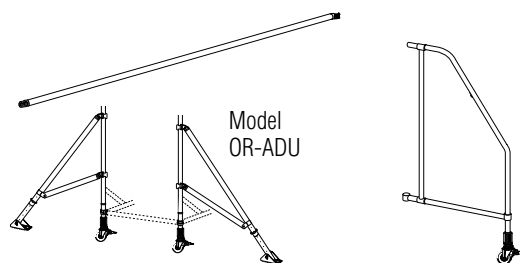

Note: Braces and Frames are ordered separately

Model No.	Description	Approx. Shipping Wt. Lbs.
BOR-N	Narrow span outrigger brace	4.0
BOR-W	Wide span outrigger brace	5.0
FRO	Rolling outrigger frame (with every frame, a brace is needed)	18.0
Knee-Type Outriggers		
OR-ADU	Adjustable 1' to 5' 6" wide for narrow or wide span scaffolds	11.0

TOE BOARD SYSTEMS

OSHA requires toe boards on scaffolds over 10' high

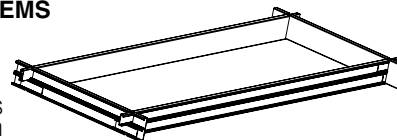

Model No.	Size	Approx. Shipping Wt. Lbs.
Aluminum Toe Board Assemblies for 4100 Series		
TN4A-6U	4" x 6'	18.0
TN4A-8U	4" x 8'	21.0
TN4A-10U	4" x 10'	25.0
Aluminum Toe Board Assemblies for 4200 Series		
TW4A-6U	4" x 6'	21.0
TW4A-8U	4" x 8'	25.0
TW4A-10U	4" x 10'	28.0

NOTICE – ALL SCAFFOLDS: Maximum scaffold platform height is equal to 4x the smaller base section dimension of the scaffold or installed outrigger in most states except California which requires 3x. Check state and local codes.

Scaffold Towers		Narrow Span (29' wide) Towers									Wide Span (4-1/2' wide) Towers									
Platform Length		6' Long			8' Long			10' Long			6' Long			8' Long			10' Long			
Component Model No.	Description	4101-12	4101-18	4101-23	4102-12	4102-18	4102-23	4103-12	4103-18	4103-23	4201-12	4201-18	4201-23	4202-12	4202-18	4202-23	4203-12	4203-18	4203-23	
FNB-80	Adjustable Base Section	2	2	2	2	2	2	2	2	2										
FNU-65	5-1/2' Upper Section	2	4	6	2	4	6	2	4	6										
FNG-42	Guard Rail	2	2	2	2	2	2	2	2	2										
FWB-80	Adjustable Base Section										2	2	2	2	2	2	2	2	2	2
FWU-65	5-1/2' Upper Section										2	4	6	2	4	6	2	4	6	6
FWG-42	Guard Rail										2	2	2	2	2	2	2	2	2	2
PD22W-6, -8, -10*	Access Door Plank	1	1	2	1	1	2	1	1	2	1	1	2	1	1	2	1	1	2	2
P22W-6, -8, -10*	Wood Deck										1	1	2	1	1	2	1	1	2	2
BH-6, -8, -10*	Horizontal Brace	8	10	12	8	10	12	8	10	12	8	10	12	8	10	12	8	10	12	12
BD-6, -8, -10*	Diagonal Brace	5	7	9	5	7	9	5	7	9	9	13	17	9	13	17	9	13	17	17
BN-6, -8, -10*	Horizontal-Diagonal	2	2	4	2	2	4	2	2	4										
BW-6, -8, -10*	Horizontal-Diagonal										2	2	4	2	2	4	2	2	4	4
FRO	Outrigger	4	4	4	4	4	4	4	4	4		4	4		4	4			4	4
BOR-N, -W	Outrigger Brace	4	4	4	4	4	4	4	4	4		4	4		4	4			4	4
TN4A-6U, -8U, -10U	Toe Board	1	1	2	1	1	2	1	1	2										
TW4A-6U, -8U, -10U	Toe Board										1	1	2	1	1	2	1	1	2	2

*-6, -8, -10 refers to platform length. Add suffix to model number for corresponding platform length.

Please follow these steps and refer to the chart below for purchasing a ladder accessory that is factory installed. Certain combinations of factory installed accessories to the same ladder are also available. Lead time for factory installed accessories may vary depending on availability. If you have a question or need assistance, please call customer service at 1-888-523-3371.

Step 1: Locate the ladder's model number and add an X on to the end of the model number.

Step 2: Use the chart provided and find the accessory you want attached. Add the 4 digit designator to the end of the ladder model number after the X.

Example: Ladder Model Number: D6220-2
 Add the X to signify factory installation: D6220-2X
 Accessory to install: APK80
 Locate accessory on chart and find that "0004" designates this accessory being added.

MODEL TO ORDER: D6220-2X0004

Attached Accessories	Description	4-Digit Designator
A6I	Combination Spur-Hoop Shoe	0038
A7I	Padded Fixed V-Rung	0005
A72	Adjustable Pole Strap	0008
A74	Cable Hooks	0003
A78	Fly Section Shoe	0058
A8I	Adjustable Pole Lashes	0089
A83	Rubber Padded Shoe	0049
A86	Spur Shoe	0007
A92	Cable Hook and V-Rung Assembly	0002
APK70	LevelLok® Ladder Leveler with 2 base units	0086
APK80	Level-Master Automatic Ladder Levelers	0004

See price list for added cost.

Werner's illustrations are representative and may not include all styles.

All accessories, attachments, and replacement parts are designed and tested for Werner Co. products only.



PaintCup & PaintCupLiner



JobBucket



UtilityBucket



JobCaddy



UtilityHook



ToolLasso®

CUSTOMIZE YOUR LADDER TOP



AC27-P	AC27-L	AC50-JB-3
Paint Cup	Paint Cup Liner	Job Bucket



Model No.	Fits on
AC27-P	OBEL00, OBPT00, OBCN00, 6200, 6100, 6000, AC24

Approx. Shipping Dimensions	Approx. Shipping Wt. Lbs.
9-1/8" x 13-3/4" x 10-7/8"	4.0

Shipping quantity (6) units per carton

- Great for trim painting and cut-in applications
- Built-in magnet to secure a paint brush
- Holds 1 quart of paint
- Can be used with disposable Paint Cup Liner AC27-L



Model No.	Fits on
AC27-L	AC27-P

Approx. Shipping Dimensions	Approx. Shipping Wt. Lbs.
5-1/8" x 13-3/8" x 10"	2.2

Shipping quantity (10) units per carton (40) liners per carton

- Disposable liner makes clean up easy
- Each AC-27L unit includes 4 liners



Model No.	Fits on
AC50-JB-3	OBEL00, OBPT00, OBCN00, 6200, 6100, 6000

Approx. Shipping Dimensions	Approx. Shipping Wt. Lbs.
15-1/4" x 11-7/8" x 16-1/4"	6.6

Shipping quantity (3) units per carton

- Increase ladder storage and maximize your work space
- Great for all trades: electrical, maintenance, plumbing, construction
- Integrated tape measure and screwdriver holders
- Top grooves hold round pipes in place
- 600 cubic inches of storage, 25 lbs. load capacity

TAKE LESS TRIPS UP THE LADDER



AC52-UB	AC54-JC	AC56-UH	AC58-TL
Utility Bucket	Job Caddy	Utility Hook	Tool Lasso®



Model No.	Fits on
AC52-UB	OBEL00, OBPT00, OBCN00, 6200, 6100, 6000

Model No.	Fits on
AC54-JC	OBEL00, OBPT00, OBCN00, 6200, 6100, 6000

Model No.	Fits on
AC56-UH	OBEL00, OBPT00, OBCN00, 6200, 6100, 6000

Model No.	Fits on
AC58-TL	OBEL00, OBPT00, OBCN00, 6200, 6100, 6000, AC24, PS-48

Approx. Shipping Dimensions	Approx. Shipping Wt. Lbs.
13-1/2" x 10-3/4" x 10-3/4"	4.5

Approx. Shipping Dimensions	Approx. Shipping Wt. Lbs.
15-1/2" x 8-3/8" x 10-3/8"	6.7

Approx. Shipping Dimensions	Approx. Shipping Wt. Lbs.
9-3/4" x 13-1/2" x 8"	2.8

Approx. Shipping Dimensions	Approx. Shipping Wt. Lbs.
10-7/8" x 12-1/4" x 9-3/4"	4.0

Shipping quantity (3) units per carton

Shipping quantity (3) units per carton

Shipping quantity (10) units per carton

Shipping quantity (12) units per carton

- Expand your work surface
- Great for jobsite or household use
- Integrated Lock-In Socket for adding Paint Cup, ToolLasso® or Utility Hook
- Ideal for wet or dry applications
- Holds up to one gallon of liquid, 25 lbs. capacity

- Holds large or odd shaped items like fluorescent bulbs or ceiling fan blades
- 4 storage compartments keep small parts separated
- Screwdriver, pliers, putty knife & towel holders
- End hook built in for increased convenience
- Integrated Lock-In Socket for adding Paint Cup, ToolLasso® or Utility Hook

- Keep cords from getting tangled in your ladder
- Organize cords and keep them within reach
- Holds extension cords, air hoses, garden hoses, strands of lights, paint sprayers and other tools or project materials

- Secures tools from falling
- Wraps around the grip of power tools, hand tools and caulk guns
- Locks into HolsterTop® to keep tools safe and ready to use
- Compatible with the ToolLasso® belt clip
- AC58-TL includes 1 belt clip and 2 ToolLassos

AC11

Stepladder Hanger



Kit No.	Approx. Shipping Weight
AC11	1.8 lbs. each

Hanger can be mounted on a wall to hold stepladders. Industrial strength coated steel wire construction.

User Installed Only

Shipping quantity (6) units per carton

PK76

Universal Auto-Closing Pail Shelf



Kit No.	Fits on	Approx. Shipping Wt.
PK76-3	Fiberglass Stepladders & Aluminum 400 Series Stepladders	2.5 lbs.

Spill-Proof®, rugged construction, easy to keep clean, automatically closes with stepladder, built-in rag rack. Pail shelf comes with mounting hardware and instructions.

User Installed Only

Shipping quantity (4) units per carton

76

Molded Plastic Pail Shelf



Kit No.	Fits on Fiberglass Series	Approx. Shipping Wt.
76-2	6000 6200	2.5 lbs.

Spill-Proof®, rugged construction, easy to keep clean, automatically closes with stepladder. Pail shelf comes with mounting hardware and instructions.

User Installed Only

Shipping quantity (2) units per carton

21

Grating Shoes



Kit No.	Fits on Series	Approx. Shipping Wt.
21-20	6200, P6200, 7300, 7400, P7400, OB Series	1.5 lbs.
21-22	T6200, T7400, PT7400	1.5 lbs.

User Installed Only

22

Fiberglass Rail Shields

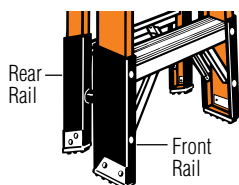

Kit No.	Fits on Front Rail of Fiberglass Series	Approx. Ship. Wt.
22-2F	6000, T6000, 6200, 7300, T6200, 7400 (MK 13 & up), T7400 (MK 11 & up), P7400 (MK 13 & up), PT7400 (MK 4 & up), E7400 (MK 7 & up)	1.5 lbs.

22-3F	7400 (up through MK 12), T7400 (up through MK 10), P7400 (up through MK 12), PT7400 (up through MK 3), E7400 (up through MK 6)	1.5 lbs.
-------	--	----------

Kit No.	Fits on Rear Rail of Fiberglass Series	Approx. Ship. Wt.
22-2R	6200, 7300, 7400, P7400	1.0 lb.

Designed to reinforce. Shields may also be used to repair ladder if rail cracks occur no higher than 3/4" below bottom rivet of bottom step or horizontal and all holes in the rail are intact. Rail shield(s) come with mounting hardware. (1 front and 1 rear kit per stepladder; 2 front kits needed for trestle ladder)

User Installed Only

PK76

Universal Pail Shelf



Kit No.	Fits on	Approx. Shipping Wt.
PK76-9	Fiberglass Stepladders & Aluminum 400 Series Stepladders	1.6 lbs.

Two piece, Spill-Proof®, rugged construction, aluminum arms, built-in rag rack. Pail shelf comes with mounting hardware and instructions.

User Installed Only

Shipping quantity (6) units per carton

AC24

Multipurpose Project Tray



Kit No.	Fits on	Approx. Shipping Wt.
AC24	MT Series M1 Series Type IA (300 lbs.) & Type IAA (375 lbs.) Stepladders	2.8 lbs.

Project Tray conveniently holds tools, paints and supplies. Made for Werner multiladders and stepladders. Attaches easily; works at multiple heights; includes ToolLasso®.

User Installed Only

40

Casters/Bracket Kits



Kit No.	Fits on Series	Approx. Shipping Wt.
40-2HD	PT370 PT6000 PT7400 (MK 4 & up)	5.0 lbs.
40-4HD	PT7400 (up through MK 3)	5.0 lbs.

Note: Fits only ladder originally equipped with casters.

Heavy duty aluminum bracket with 4" caster allows 360° mobility of ladder. Soft rubber wheels are easy on floors; designed to roll over door thresholds. Casters may be used on all 4 legs; order 2 kits for this purpose. Two (2) casters/brackets come with mounting hardware and instructions.

Order models below as a "-4C" for factory installation.

User Installed Only

LADDER JACKS

Recommended for use with 300 lbs. Type IA and 375 lbs. Type IAA extension ladders (OSHA and ANSI allow use with 250 lbs. Type I extension ladders also)

User Installed Only



2-Rung Model AC10-14-02
Short Body
Accepts Stages to 14" width



2-Rung Model AC10-20-02
Long Body
Accepts Stages to 20" width



3-Rung Model AC10-20-03
Long Body
Accepts Stages to 20" width

- Lightweight, sturdy, easy to use
- Designed for quick field adjustments
- Mounts on either side of extension ladder

Kit No.	Approx. Shipping Wt.
AC10-14-02	15.0 lbs.
AC10-20-02	18.0 lbs.
AC10-20-03	20.0 lbs.

Shipping quantity
2 per unit;
(1) unit per carton

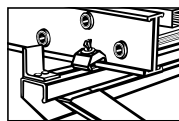

PLATFORM CLAMP SYSTEM
Clamp secures platform to ladder jacks and ties supporting ladders together to help secure entire ladder jack system

AC18MT

Platform



Kit No.	Fits on	Approx. Shipping Wt.
AC18MT	MT Series	4.5 lbs.

Slip-resistant surface. Aluminum construction. Kicks out of way for easy climbing. 300 lbs. load capacity.

User Installed Only

AC19

Extension Ladder Covers



Kit No.	Fits on	Approx. Shipping Wt.
AC19-2	ALL Single and Extension Fiberglass and Aluminum Ladders (except 500, D500, D7136-2, D7140-2)	1.2 lbs. each

Helps prevent damage to support surfaces. Designed to 'snap' over extension ladder rail end caps. Resists paints, stains, thinners and solvents.

User Installed Only

Shipping quantity 1 pair per unit;
(6) units per carton

AC22

Paint Can/Bucket Hanger



Kit No.	Fits on	Approx. Shipping Wt.
AC22	ALL Extension Ladders	0.5 lbs. each

Holds one gallon can. Easy on and off. Right or left hand use. Plated steel.

User Installed Only

Shipping quantity
(6) units per carton

FRB4510-10

Fixed Roof Bracket



Carton Dimensions	Approx. Shipping Wt.
9-3/8" x 18-1/4" x 9-1/4"	22.0 lbs.

Accommodates a 12/12, 45-degree roof pitch

Shipping quantity
(10) units per carton

AC20

Paint Can Hook



Kit No.	Fits on	Approx. Shipping Wt.
AC20	ALL Extension Ladders	0.4 lbs. each

Includes 2 steel hooks with can openers. Holds one gallon can. 3/16" diameter.

User Installed Only

Shipping quantity
2 per unit;
(12) units per carton

AC78

Quickclick™ Stabilizer



Kit No.	For use on Singles and Extensions with	Approx. Ship Wt.
AC78	1-1/4" round rungs 1-1/2" flat rungs 1-3/4" flat rungs 1-5/8" flat rungs	6.4 lbs.

Span: 44", Standoff :10"
Requires no tools. Spring-loaded locking latch makes it easier and quicker to install/remove than any other stabilizer on the market. Mar-resistant rubber end caps protect work surface. Stabilizer comes with instructions. Paint can hook included.

User Installed Only

Not for use on Werner MultiLadders, Type III Aluminum or Type II Fiberglass extension ladders

Shipping quantity
(1) unit per carton

ARBIO-10

Adjustable Roof Bracket

Carton Dimensions	Approx. Shipping Wt.
4-5/8" x 19-1/2" x 14-1/4"	25.0 lbs.

User Installed Only

Shipping quantity
(10) units per carton

AC96

Aluminum Stabilizer



Kit No.	Fits on	Ladder Size	Approx. Shipping Wt.
AC96	Aluminum Series Extension Ladders with rails up to 3" x 1-3/16"	ALL	4.5 lbs.
D716		16'	
D1100		ALL	
D1200		ALL	
D1300		ALL	
D1500		ALL	
D500		20' - 24'	
MT		ALL	
M1		ALL	

Span: 47", Standoff :10"
 For use on aluminum ladders of all duty ratings. Attaches in minutes. Mar-resistant rubber caps protect work surface. Paint can hook included. Comes with mounting hardware and instructions.

User Installed Only

Ideal for stabilizing M1 MultiLadder when in scaffold or stairway positions

Shipping quantity
 (6) units per carton

PK70-1/APK70

Leveler with Base Units



Kit No.	Fits on All	Approx. Shipping Wt.
PK70-1 and APK70	MT Series, D7100, D6200, 7100, D1300, D1500, 7800	8.5 lbs.

Levelok® Ladder Leveler with 2 base attachments. Base unit stays attached to the ladder while leveler can be easily removed when not in use. Swivel shoe with ice pick on both ends. Leveler can be used on either side of ladder. Provides 8-1/2" of travel.

Levelok® is a registered trademark of the Levelok Corporation.

User or Factory Installed

PK70-2

Leveler Base Units



Kit No.	Fits on All	Approx. Shipping Wt.
PK70-2	MT Series, D7100, D6200, 7100, D1300, D1500, 7800	3.2 lbs.

Levelok® Ladder Leveler 2 base attachments. Base units attach to the ladder to be used with Levelok® Leveler supplied with PK70-1.

Levelok® is a registered trademark of the Levelok Corporation.

User Installed Only

PK70-3

Leveler



Approximate Shipping Weight
 6.2 lbs.

Levelok® Ladder Leveler attaches to the base units supplied with PK70-1 and PK70-2.

Levelok® is a registered trademark of the Levelok Corporation.

PK80/APK80

Level-Master® Automatic Ladder Levelers



Kit No.	Fits on Fiberglass Series	Ladder Size
PK80-2 & APK80	D5900, D6000, D6200, 7100, D7100	ALL ALL ALL ALL

Kit No.	Fits on Aluminum Series	Ladder Size
PK80-2 & APK80	D1100, D1200, D1300, D1500, D500	ALL ALL ALL

Note: The original shoes of a D1500 series ladder may replace the steel shoes on a model PK80-2.

Approx. Shipping Weight

9.5 lbs.

Approx. Added Weight to Ladder for Factory Install

6.5 lbs.

Shipping quantity
 (1) unit per carton

Easily attaches to Werner fiberglass and aluminum extension ladders to level ladder on uneven surfaces.

Automatically adjusts up to 8-1/2". Easily levels and locks securely in place. The width of the ladder is increased by approximately 3-3/4". Note: The ladder's duty rating will remain the same after proper installation of leveler. Two (2) ladder levelers (one for each ladder rail) come with mounting hardware and instructions.

User or Factory Installed

A61

Combination Spur-Hoop Shoe



Factory Install No.	Fits on Fiberglass Series	Ladder Size
A61	D6200-2, 7100-2, D7100-2	16' - 32' ALL 16' - 32'

Approx. Added Weight to Ladder for Factory Install
 3.0 lbs.

Combination aluminum rail shield bracket and spur-hoop shoe assembly.

Factory Installed Only

A62

Flange Guards



Factory Install No.	Fits on Fiberglass Series	Ladder Size
A62	7100-2, 7200-2, D7100-2, D7200-2, D8100-2	16' - 32' ALL 16' - 32' ALL ALL

Approx. Added Weight to Ladder for Factory Install
 4.0 lbs.

Black plastic guards prevent damage to ladder rails.

Factory Installed Only

66-1/A66-1

Reflective Tape



Kit No.	Fits on	Approx. Shipping Wt.
66-1	All Ladders	0.04 lbs.

Factory Install No.	Fits on	Ladder Size
A66-1	All Ladders	ALL

Highly reflective tape to add visibility to ladders. User-installed kit includes two 12" strips.

User or Factory Installed

71/A71

Padded Fixed V-Rung



Kit No.	Fits on Fiberglass Series	Ladder Size
71-1	D6200-2 7100-2 D7100-2 7800	ALL ALL 16' - 32' ALL
71-4	D6200-1 7100-1	ALL Up to 16'

Factory Install No.	Fits on Fiberglass Series	Ladder Size
A71	D6200-1 D6200-2 7100-1 7100-2 D7100-2 7800	ALL ALL Up to 16' ALL 16' - 32' ALL

Approx. Shipping Weight

71-1: 1.5 lbs.
71-4: 2.0 lbs.

Approx. Added Weight to Ladder for Factory Install

1.4 lbs.

Slip-resistant rubber grip attached to steel v-rung for wood, metal or concrete poles. Pre-pierced holes in fiberglass top rails are provided to accept this accessory. V-rung assembly comes with mounting hardware and instructions.

72/A72

Adjustable Pole Strap



Kit No.	Fits on Fiberglass Series	Ladder Size	Approx. Ship. Wt.
72-2	D6200-2 7100-2 D7100-2	ALL Up to 16' 16' - 32'	1.3 lbs.
72-1	D6200-1 7100-1	ALL Up to 16'	1.3 lbs.

Factory Install No.	Fits on Fiberglass Series	Ladder Size
A72	D6200-2 7100-1 7100-2 D7100-2	ALL Up to 16' ALL 16' - 32'

Adjustable strap design for all diameter poles. Slip-resistant rubber grip stitched to strap. Strap assembly comes with mounting hardware and instructions.

User or Factory Installed

74/A74

Cable Hooks



Kit No.	Fits on Fiberglass Series	Ladder Size	Approx. Ship. Wt.
74-1	D6200-2 7100-1 7100-2 D7100-2	ALL Up to 16' ALL 16' - 32'	2.6 lbs.
74-2	D7100-2	36' - 40'	2.6 lbs.

Factory Install No.	Fits on Fiberglass Series	Ladder Size
A74	D7100-2	ALL

Easily folds within side rails for storage. Cable hooks can be mounted above or below top rung. Consult Werner if using in conjunction with other accessories. Cable hooks come with mounting hardware and instructions.

User or Factory Installed

A78

Fly Section Shoes w/ Quick Disconnect

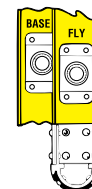

Factory Install No.	Fits on Fiberglass Series	Ladder Size
A78	D6200-2 7100-2 D7100-2	ALL ALL 16' - 32'

Approx. Added Weight to Ladder for Factory Install

1.5 lbs.

Combination aluminum rail shield bracket and hoop shoe with corrugated slip-resistant extruded rubber pad on fly section, allows use as a single or manhole ladder assembly.

Factory Installed Only

81/A81

Adjustable Pole Lashes



Kit No.	Fits on Fiberglass Series	Ladder Size	Approx. Shipping Wt.
81-3	D7100-2	36' - 40'	1.5 lbs.

Factory Install No.	Fits on Fiberglass Series	Ladder Size
A81	D6200-2	ALL
	7100-1	ALL
	7100-2	ALL
	D7100-2	ALL

For use with ladders having hoop style end caps only. Adjustable strap design for all diameter poles. Adjustable pole lash comes with mounting hardware and instructions.

User or Factory Installed

A83

Rubber Padded Shoe



Factory Install No.	Fits on Fiberglass Series	Ladder Size
A83	D6200-1	ALL
	D6200-2	16' - 32'
	7100-1	Up to 16'
	7100-2	ALL
	D7100-2	16' - 32'

Approx. Added Weight to Ladder for Factory Install
2.2 lbs.

Aluminum protective rail shield and rubber padded foot. Comes with two (2) padded shoes.

Factory Installed Only

89

Rail Wear Sleeves



Kit No.	Fits on Fiberglass Series	Ladder Size	Approx. Shipping Wt.
89-1	M7100-1	ALL	2.5 lbs.
	7100-1	Up to 16'	

3' long replaceable plastic sleeves help avoid manhole rim damage to ladder rails. Two (2) sleeves, mounting hardware and instructions included.

User Installed Only

92/A92

Cable Hook and V-Rung Assembly



Kit No.	Fits on Fiberglass Series	Ladder Size
92-88	D6200-2	16' - 40'
	D8200-2EQ	20' - 28'
92-89	7100-2, D7100-2	16' - 32'
	D7100-2LV	20' - 32'
92-91	7100-1	8' - 16'
92-92	D6200-3	16' - 32'

Factory Install No.	Fits on Fiberglass Series	Ladder Size
A92	D6200-2	ALL
	D6200-3	ALL
	7100-2	ALL
	7100-1	8' - 16'
	D8200-2EQ	ALL
	D7100-2	16' - 32'
	D7100-2LV	20' - 32'

Approx. Shipping Weight

4.0 lbs.

Approx. Added Weight to Ladder for Factory Install

3.0 lbs.

Functions as both cable hook and v-rung. For use in applications where the diameter of the pole at the point of support does not exceed 10". Steel v-rung has rubber pad for slip-resistant performance. One (1) cable hook and v-rung assembly, mounting hardware and instructions included.

User or Factory Installed

A82

Red Rungs



Factory Install No.	Fits on Fiberglass Series	Ladder Size
A82-1	D7100-2	16' - 32'
	D7200-2	16' - 32'
	D8100-2	ALL
A82-2	D7100-2	ALL
A82-3	D7100-2	36' - 40'

Set of 3 painted red rungs for fiberglass extension ladders. Available for rung-plate models only.

Factory Installed Only

86/A89

Spur Shoe



Kit No.	Fits on Fiberglass Series	Ladder Size
86-1	D6200-2	16' - 32'
	7100-2, D7100-2	16' - 32'
	7100-1	Up to 16'

Factory Install No.	Fits on Fiberglass Series	Ladder Size
A86	D6200-1	ALL
	D6200-2	16' - 32'
	7100-1	Up to 16'
	7100-2	ALL
	D7100-2	16' - 32'

Approx. Shipping Weight

2.5 lbs.

Approx. Added Weight to Ladder for Factory Install

2.0 lbs.

Plated steel spur for use on penetrable surfaces. Two (2) spur shoe assemblies, mounting hardware and instructions included.

User or Factory Installed

91

Adjustable Pole Lash Assembly w/Angle Brackets

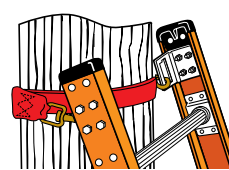

Kit No.	Fits on Fiberglass Series	Ladder Size	Approx. Shipping Wt.
91-2	D6200-2	ALL	2.0 lbs.
	7100-2	ALL	
	D7100-2	16' - 32'	

This assembly comes with brackets for independent use; wraps around pole. Strap design for all diameter poles. Adjustable pole lash assembly comes with two (2) angle brackets, mounting hardware and instructions.

User Installed Only

94

Ladder-Cinch™



Kit No.	Fits All	Ladder Size	Approx. Shipping Wt.
94-2	Fiberglass Series Extension Ladders	ALL	1.0 lbs.

Use as a quick tie down. Strap designed for all diameter poles. One (1) Ladder-Cinch™ assembly, storage bag and instructions.

User Installed Only

AC59

Attic Ladder Installation and Trim Kit



Kit No.	Fits on	Approx. Shipping Wt.
AC59	ALL Attic Ladders	8.25 lbs. each

This kit includes temporary support boards, shims and fasteners for installing your attic ladder. Once installed, this kit also included mitered trim boards to improve the attic ladder's appearance.

User Installed Only

97P

Adjustable True Grip® Stabilizer & Surface Protectors

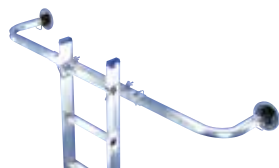

Kit No.	Fits on Aluminum Series	Ladder Size
97P	D716-2	16'
	D1100	ALL
	D1200	ALL
	D1300	ALL
	D1500	ALL
	D500-2	20' - 24'
	D1700-2EQ	ALL
	D1800-2EQ	ALL

Note: Not to be used on Multi-Ladders
Approx. Shipping Weight
9.5 lbs.

Span adjustment : 49", 57" or 65"
Stand-off distance: 12" or 29-1/2"
Rectangular stabilizer spans double windows. Quickly converts stand off distance for larger overhangs. Mounts quickly and easily. This comes with one (1) stabilizer, rubber pads, fleece bonnets, mounting hardware and instructions.

- Fits rail up to 3" x 1-3/16"

User Installed Only

36-82

Attic Ladder Assist Pole



Kit No.	Fits on	Approx. Shipping Wt.
36-82	ALL Attic Ladders	3.0 lbs. each

3' assist pole allow easy access and smooth opening of attic ladder door.

User Installed Only



SERIES/MODEL	STYLE	PAGE	SERIES/MODEL	STYLE	PAGE
150B	Aluminum Step Stool	37	86/A86	Spur Shoe	68
21	Grating Shoes	64	89	Rail Wear Sleeves	68
22	Fiberglass Rail Shields	64	91	Adjustable Pole Lash Assembly with Angle Brackets	68
244	Aluminum Utility Ladder	35	92/A92	Cable Hook and V-Rung Assembly	68
260	Aluminum Platform Ladder	35	94	Ladder-Cinch™	69
2000	1-Person Decorator Plank	54	97P	Adjustable True Grip® Stabilizer and Surface Protectors	69
2300	2-Person Scaffold Plank	54	9500	All-Fiberglass Extension Ladder/Single Ladder	28
2400	2-Person Scaffold Plank	54	A61	Combination Spur-Hoop Shoe	66
2500	2-Person Stage Platform	54	A62	Flange Guards	66
2600	2-Person Stage Platform	54	A78	Fly Section Shoes with Quick Disconnect	67
2700	2-Person Stage Platform	54	A82	Red Rungs	68
36-82	Attic Ladder Assist Pole	69	A83	Rubber Padded Shoe	68
37	Display Rack	35	AA	Aluminum Compact Attic Ladder	48
350	Aluminum Stepladder	34	AC10-14-02	2-Rung Short Body Ladder Jack	65
360	Aluminum Stepladder	34	AC10-20-02	2-Rung Long Body Ladder Jack	65
370	Aluminum Stepladder	31	AC10-20-03	3-Rung Long Body Ladder Jack	65
3100	3-Person Stage Platform	54	AC11	Stepladder Hanger	64
3200	3-Person Stage Platform	54	AC18MT	Platform	65
40	Casters/Bracket Kits	64	AC19	Extension Ladder Covers	65
41-1	Swivel Base Plate	59	AC20	Paint Can Hook	65
43-1	Guard Rail Holder	59	AC22	Paint Can/Bucket Hanger	65
400	Aluminum Stepladder	30	AC24	Multipurpose Project Tray	64
4100	Narrow Span Scaffold Sections	58	AC27-L	Lock-In Paint Cup Liner	62
4100-12	Narrow Span Scaffold Tower 12' Platform Height	57	AC27-P	Lock-In Paint Cup	62
4100-18	Narrow Span Scaffold Tower 18' Platform Height	57	AC50-JB-3	Lock-In Job Bucket	62
4100-23	Narrow Span Scaffold Tower 23' Platform Height	57	AC52-UB	Lock-In Utility Bucket	63
4200	Wide Span Scaffold Sections	58	AC54-JC	Lock-In Job Caddy	63
4200-12	Wide Span Scaffold Tower 12' Platform Height	57	AC56-UH	Lock-In Utility Hook	63
4200-18	Wide Span Scaffold Tower 18' Platform Height	57	AC58-TL	Lock-In ToolLasso®	63
4200-23	Wide Span Scaffold Tower 23' Platform Height	57	AC59	Attic Ladder Installation and Trim Kit	69
500-1	Aluminum Round Rung Straight Ladder	38	AC78	Quickclick™ Stabilizer	65
560-3	Aluminum Round Rung Extension Ladder	39	AC96	Aluminum Stabilizer	66
5300	Plywood Decked Aluma-Plank™	51	AH	Aluminum Universal Attic Ladder	48
5500	Aluminum Decked Aluma-Plank™	51	AP	Aluminum Work Platforms	46-47
5600	2-Piece Extruded Aluma-Board™	51	ARB10-10	Adjustable Roof Bracket	65
5900	Fiberglass Stepladder	16	BD	Scaffold Diagonal Brace	59
6000	Fiberglass Stepladder	15	BH	Scaffold Horizontal Brace	59
6002	Fiberglass Step Stool	14	BN	Scaffold Narrow Span Horizontal-Diagonal Brace	59
6100	Fiberglass Stepladder	14	BOR	Scaffold Outrigger Brace	59
6200	Fiberglass Stepladder	10	BW	Scaffold Wide Span Horizontal-Diagonal Brace	59
6202	Fiberglass Step Stool	13	C6200	Fiberglass Compact Stepladder	11
66-1/A66-1	Reflective Tape	67	D1100	Aluminum D-Rung Extension Ladder	42
71/A71	Padded Fixed V-Rung	67	D1200-2	Aluminum D-Rung Extension Ladder	41
72/A72	Adjustable Pole Strap	67	D1200-3	Aluminum D-Rung Compact Extension Ladder	41
74/A74	Cable Hooks	67	D1300	Aluminum D-Rung Extension Ladder	40
76	Molded Plastic Pail Shelf	64	D1500	Aluminum D-Rung Extension Ladder/Straight Ladder	39
7100	Fiberglass Round Rung Extension/Straight Ladder	23	D1700-2EQ	Aluminum Extension Ladder with Integrated Leveling	40
7300	Fiberglass Stepladder	8	D1800-2EQ	Aluminum Extension Ladder with Integrated Leveling	40
7400	Fiberglass Stepladder	6	D500-2	Aluminum Flat Rung Extension Ladder	38
7800	Fiberglass Combination Step/Extension Ladder	27	D5900	Fiberglass D-Rung Extension Ladder	25
81/A81	Adjustable Pole Lashes	68	D6000	Fiberglass D-Rung Extension Ladder	25

SERIES/MODEL	STYLE	PAGE	SERIES/MODEL	STYLE	PAGE
D6200-2/ D6200-1	Fiberglass D-Rung Extension Ladder/Straight Ladder	24	PJ-WB	Aluminum Pump Jack Work Bench	52
D6200-3	Fiberglass D-Rung Compact Extension Ladder	24	PK70-1/APK70	Ladder Leveler with Base Units	66
D6200-2GHV	Fiberglass D-Rung Extension Ladder/Straight Ladder	24	PK70-2	Ladder Leveler Base Units	66
D716-2	Aluminum D-Rung Extension Ladder	42	PK70-3	Ladder Leveler	66
D7100-2	Fiberglass D-Rung Extension Ladder	22	PK76	Universal Pail Shelf	64
D7100-2GHV	Fiberglass High Visibility Ext. Ladder	22	PK80/APK80	Level-Master® Automatic Ladder Levelers	66
D7100-2LV	Fiberglass D-Rung Ext. Ladder w/ Integrated Leveling	22	PS-48	Steel Portable Scaffold	50
D8200-2EQ	Fiberglass Extension Ladder with Integrated Leveling	23	PT370	Aluminum Stockr's Ladder®	33
DP6206	Fiberglass Dual-Purpose 2-IN-1 6' Ladder	21	PT6000	Fiberglass Stockr's Ladder®	16
DP6207	Fiberglass Dual-Purpose 2-IN-1 7' Ladder	21	PT7400	Fiberglass Stockr's Ladder®	7
DP6208	Fiberglass Dual-Purpose 2-IN-1 8' Ladder	21	S7700	Fiberglass Interchangeable Parallel Sectional Ladder	29
E7400	Fiberglass Extension Trestle Ladder	8	S7900	Fiberglass Interchangeable Tapered Sectional Ladder	28
ERT-N	End Rail and End Toe Board Assembly - Narrow	55	SGR-09	1-1/2" Square Guard Rail Cut Length - 108"	55
ERT-W	End Rail and End Toe Board Assembly - Wide	55	SGR-13	1-1/2" Square Guard Rail Cut Length - 156"	55
FMT	Fiberglass Multi-Position Ladder	20	SH378	Aluminum Shelf Ladder	33
FNB-80	Scaffold Base End Frame	59	SNB	Snap-Up® Narrow Span Folding Scaffolds	58
FNU	Scaffold Frames	59	SPF00	Fiberglass Posting Ladder	29
FRB4510-10	Fixed Roof Bracket	65	SPJ-100	Steel Pump Jack	53
FRO	Scaffold Rolling Outrigger Frame	59	SPJ-GRH	Steel Pump Jack Guard Rail Holder	53
FTP6200	Fiberglass Tripod Stepladder	12	SPJ-PA-4	Steel Pump Jack Pole Anchor	53
FWB-80	Scaffold Base End Frame	59	SPJ-SBF	Steel Pump Jack Foldable Support Brace	53
FWG-42	Scaffold Guard Rail End Frame	59	SPJ-WB	Steel Pump Jack Work Bench/Guard Rail Holder	53
FWU	Scaffold Frames	59	SRS-72 & Accessories	6' Steel Rolling Scaffold	50
L6200	LEANSAFE™ Ladder	9	SSA00	Aluminum Step Stand	37
L7300	LEANSAFE™ Ladder	9	SSF00	Fiberglass Step Stand	13
M1A	Aluminum Folding MultiLadder	44	SSP-47	Stanchion Post Assembly	55
M1AA	Aluminum Telescoping MultiLadder	45	STB-09	3-1/2" Toe Board Cut Length - 108"	55
M7100	Fiberglass Manhole Ladder	27	STB-13	3-1/2" Toe Board Cut Length - 156"	55
MT	Aluminum Telescoping MultiLadder	44	SWB	Snap-Up® Wide Span Folding Scaffolds	58
OR-ADU	Scaffold Knee-Type Outriggers	59	T370	Aluminum Multi-Use Twin Stepladder	32
P22W	Scaffold Board	59	T372	Aluminum Twin Step Stool	37
P370	Aluminum Platform Ladder	32	T400	Aluminum Multi-Use Twin Stepladder	30
P400	Aluminum Platform Ladder	31	T6000	Fiberglass Multi-Use Twin Stepladder	15
P6200	Fiberglass Platform Ladder	12	T6200	Fiberglass Twin Stepladder	11
P7400	Fiberglass Platform Ladder	7	T6202	Fiberglass Twin Step Stool	13
PA200	Aluminum Extension Plank	51	T7400	Fiberglass Multi-Use Twin Stepladder	6
PD22W	Scaffold Wood Deck with Access Door	59	TN4A	Aluminum Toe Board Assemblies for 4100 Series	59
PD6200	Podium Ladder	19	TPF00	Fiberglass Posting Ladder	29
PD7300	Podium Ladder	19	TW370-30	Aluminum Portable Work Stand	37
PJ-6P	Aluminum Pump Jack 6' Aluminum Pole	52	TW4A	Aluminum Toe Board Assemblies for 4200 Series	59
PJ-12P	Aluminum Pump Jack 12' Aluminum Pole	52	TW6200	Fiberglass Portable Work Stand	13
PJ-18P	Aluminum Pump Jack 18' Aluminum Pole	52	W	Wood Folding Attic Ladder	49
PJ-24P	Aluminum Pump Jack 24' Aluminum Pole	52	WH	Wood Folding Heavy Duty Attic Ladder	49
PJ-100	Aluminum Pump Jack	52	WNS	Nestable Stage	52
PJ-ERN	Aluminum Pump Jack End Rail Kit (narrow)	52			
PJ-ERW	Aluminum Pump Jack End Rail Kit (narrow)	52			
PJ-PC	Aluminum Pump Jack Pole Connector	52			
PJ-PF-4	Aluminum Pump Jack Pole Foot	52			
PJ-SBF	Aluminum Pump Jack Foldable Support Brace	52			
PJ-SBR	Aluminum Pump Jack Rigid Support Brace	52			
PJ-SN	Aluminum Pump Jack Safety Net	52			





U.S. HEADQUARTERS
Werner Co.
93 Werner Road
Greenville, PA 16125-9499

To contact us, please visit:
wernerco.com