

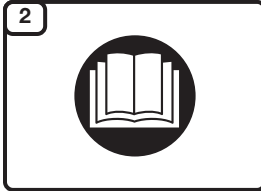

1
Read the operator's manual thoroughly before operating the unit. Follow all warnings and safety instructions. This fast guide is intended as a reference for users that have already read the operator's manual and are familiar with the necessary safety precautions.

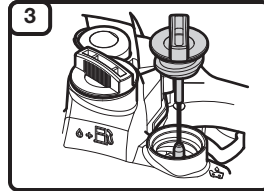

2
ASSEMBLY
This unit must be checked for proper chain tension prior to use. Refer to the operator's manual for complete instructions. Check the chain tension frequently.



3
Set the unit on a flat, level surface. Unscrew the chain oil cap. Carefully pour the bar and chain oil into the chain oil reservoir. **DO NOT** overfill.

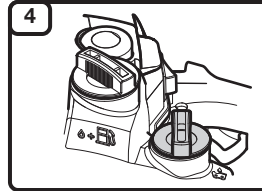

4
Reinstall the chain oil cap. Wipe up any oil that may have spilled.
NOTE: Oil will slowly flow from the reservoir onto the chain. Check the chain oil level frequently.

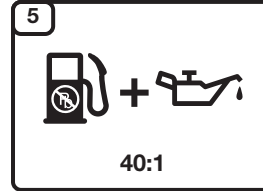

5
40:1
Mix thoroughly in a separate fuel can:
– 3.2 fl. oz. of 2-cycle engine oil
– 1 gallon of fresh unleaded gasoline (less than 30 days old)
NOTE: Do not mix directly in the unit fuel tank.

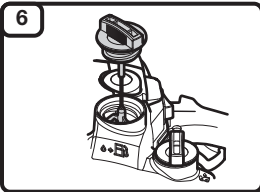
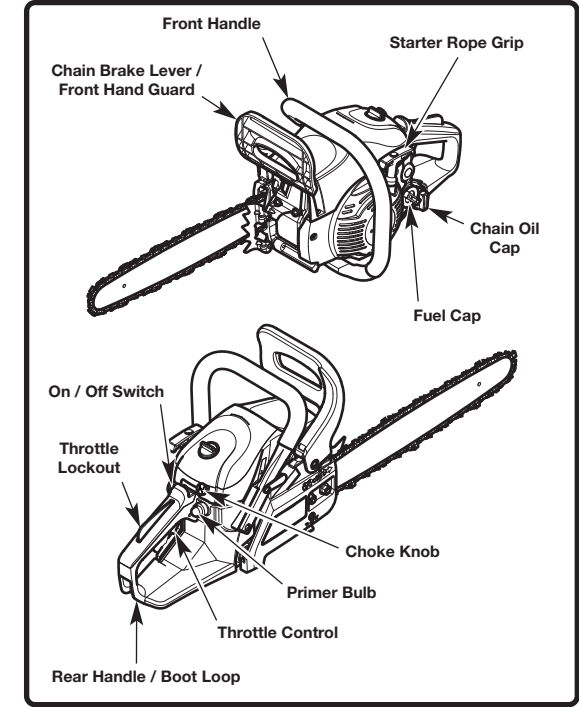

6
Position the unit with the fuel cap facing up. Slowly remove the fuel cap. Fill the fuel tank. Reinstall the fuel cap. Move the unit at least 30 ft. (9.1 m) from the fuel container and the fueling site before starting the engine.

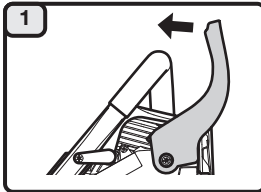

1
STARTING
Make sure the chain brake is disengaged. Pull the chain brake lever back toward the front handle.

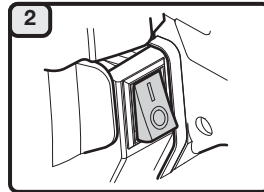

2
Move the On/Off switch to the On position.

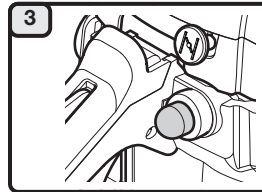

3
Slowly press and release the primer bulb **10 times**, or until fuel is visible.

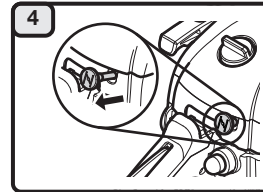

4
Pull the choke knob out to **Position 1**.
NOTE: DO NOT touch the throttle control until step 9.

ASSEMBLY TOOLS REQUIRED
• Multi-purpose tool (provided) - for chain tensioning

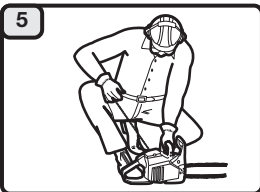

5
Set the unit on a flat, level surface. Crouch in the starting position. Hold the front handle with the left hand. Hold the starter rope grip with the right hand. Insert the right foot into the boot loop to help hold the unit firmly in place.

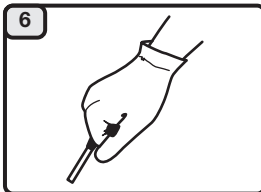

6
Pull the starter rope with a controlled and steady motion **5 times**.

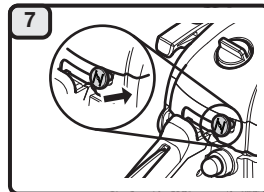

7
Push the choke knob in to **Position 2**.

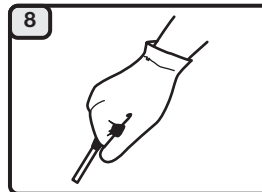

8
Pull the starter rope with a controlled and steady motion **3 to 5 times** to start the engine.
Allow the engine to warm up for 30 to 60 seconds.

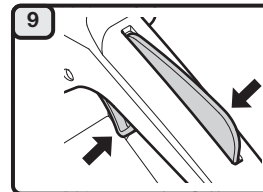

9
Press and hold the throttle lockout. Lightly squeeze and release the throttle control to idle the engine.

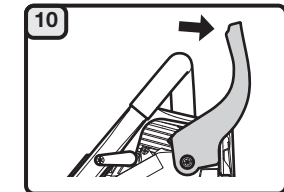

10
To reduce the chance of injury, engage the chain brake until you are ready to begin operation. When ready, disengage the chain brake.
Press the throttle lockout and squeeze the throttle control to accelerate the engine, as needed.

DIDN'T START?
Repeat the starting instructions.
If the unit still fails to start, refer to the operator's manual for additional starting and troubleshooting information.



IMPORTANT: READ THE OPERATOR'S MANUAL THOROUGHLY AND FOLLOW THE SAFE OPERATION PRACTICES WHILE OPERATING THE UNIT.

Lea la traducción en Español en el manual.