

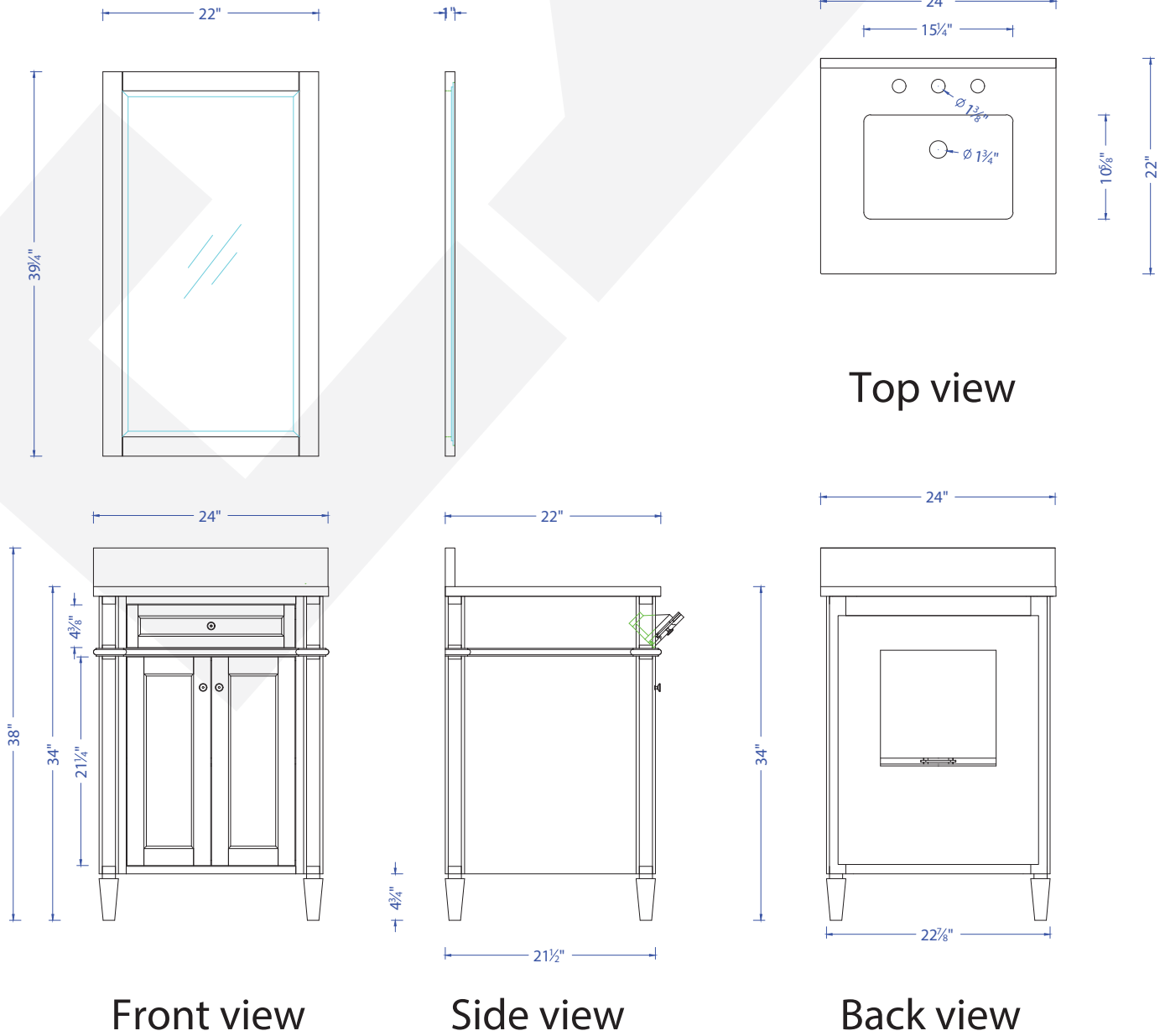

Birmingham Collection

HKGB-107-24-E-CWMT | HKGB-107-24-G-CWMT | HKGB-107-24-W-CWMT

Vanity



Birmingham Collection

Dimensions

NOTE:
All dimensions & specifications are approximate and subject to change without notice.

MIRROR INSTALLATION INSTRUCTION

TOOLS FOR ASSEMBLY



- 1 Measure the distance between the brackets on the back of the mirror

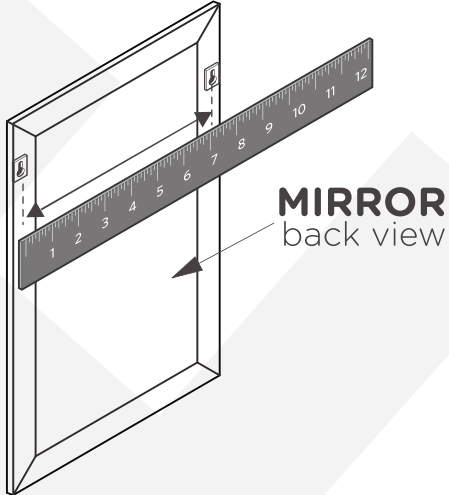

- 2 Mark the measured distance on the wall using a level

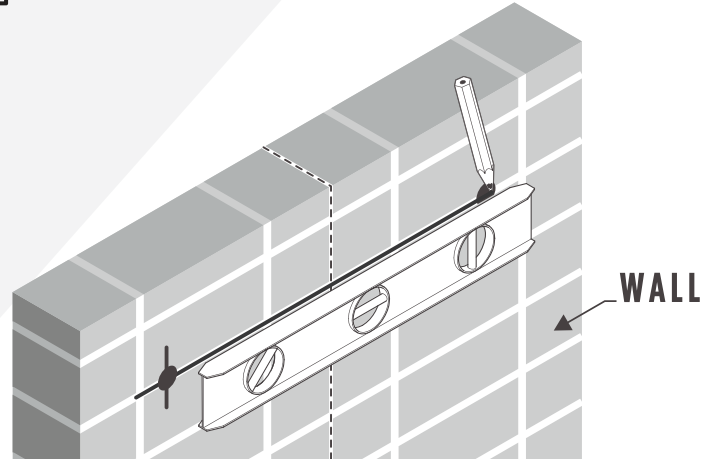

- 3 Once position is marked, drill 2 holes and insert anchors if stud is not available

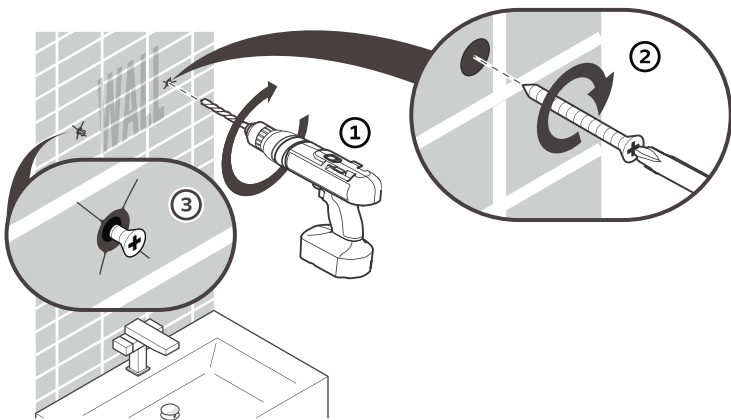

- 4 Hang mirror on the wall

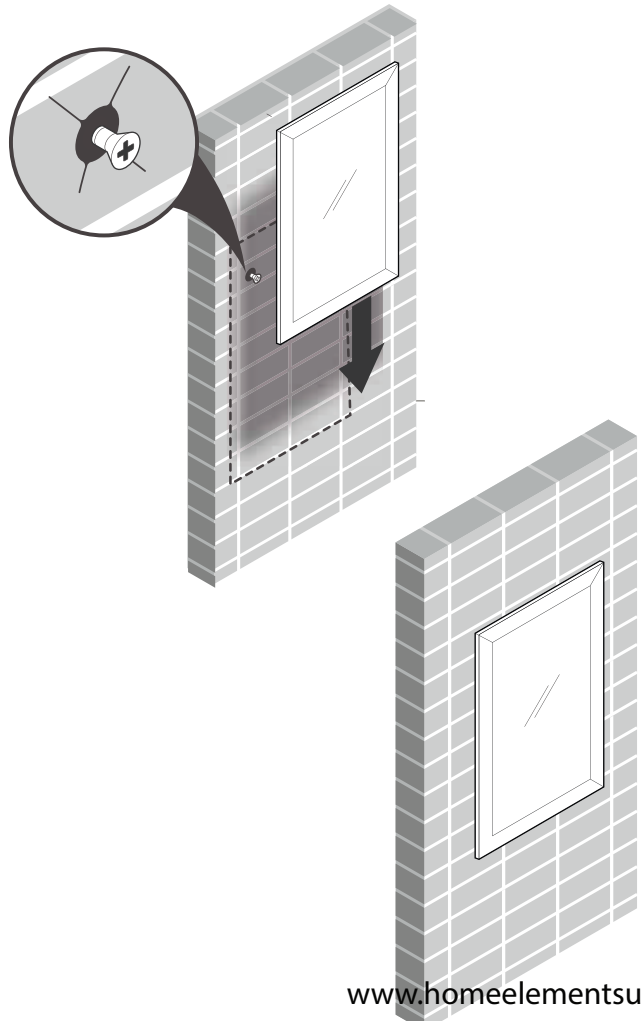

IMPORTANT:

CONSULT AN EXPERT FOR THE PROPER SCREWS/BOLTS TO USE WHEN ATTACHING TO VARIOUS WALL CONSTRUCTIONS. SCREWS PROVIDED **DO NOT ATTACH** TO ALL WALL CONSTRUCTION TYPES.

WARRANTY

Limited Warranty

Home Elements Distribution LLC products carry a one-year limited manufacturing warranty to the first and original purchaser (non-transferable) and is only applicable to products used in residential applications within the United States. The warranty period expires one year from the date of delivery of the item and limited to the repair or replacement of the defective unit or part and does not include labor for removal or replacement. This warranty does not cover any damage associated with installation or labor charges associated with the repair, removal, assembly, reinstallation or consequential damages. This warranty does not cover product failure caused by improper treatment, handling, or use other than for what the product was intended. This warranty is void if the product has been moved from its initial place of installation. Home Elements Distribution LLC reserves the right to make changes to the product line and specifications without notice. If a warranty is filed for an obsolete or a modified product, Home Elements LLC will replace the part(s) with similar style that we currently offer. This warranty does not apply to local building code compliance. The buyer should check with the local related building and plumbing codes before purchase and installation.

Bathroom vanities and kitchen cabinets are made of naturally variable raw materials. There is a +/- 3mm tolerance on the overall size of the units for both bathroom vanities and kitchen cabinets. Natural variance in grain character and color among wood and plant species and stones and minerals are naturally occurring variations and are not within the control of the manufacturer nor considered defects under this warranty. Potential cracking in and around joints may occur and are not considered to be manufacturing defects as they are considered natural characteristics of wood products in relation to their environment and are not able to be covered under this warranty. Color changes and/ or surface damage (such as splitting/ cracking) caused by exposure to extreme temperatures, direct sunlight, household cleaners, smoke, moisture/ humidity, or other environmental conditions are not covered by this warranty. Color variations in stone are a natural occurrence. Product (or replacements) may not match images, display samples and/or existing pieces. Natural stone characteristics including grain variations, color, mineral streaks and any other natural occurring features are not considered defective product.

As wood ages, it may darken and change in color over time due primarily to exposure to light. While this color change may appear over a period of time. We do not guarantee exact color match on replacements pieces

Claims

Claims for defective kitchen cabinets and bathroom vanities must be submitted to Home Elements Distribution LLC in writing with images and specific details as to the defect. After Home Elements Distribution investigated the claim, they will notify customer as to whether or not to replace or repair the defects to the cabinets, vanity and/ or accessories. All claims must be submitted to the following address: Home Elements Distribution Customer Service, 2396 Industrial Drive, Neenah WI 54956 USA.