

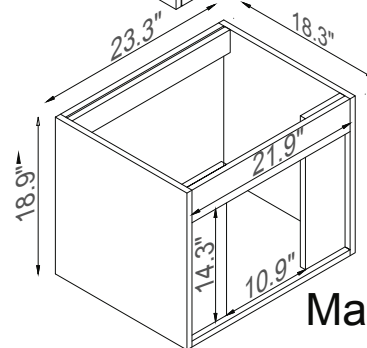

Streamline

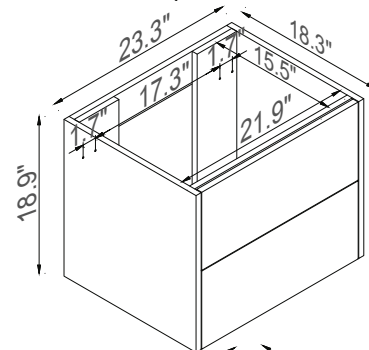
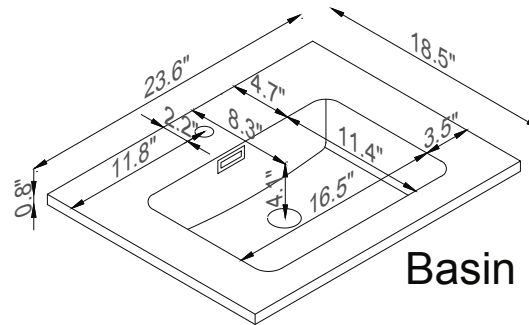

K1500-161-24-51