

Item #1000 952 272
 Item #1000 265 860
 Item #1000 952 286
 Item #1000 246 603
 Model #T24-11-B
 Model #T24-WH-B
 Model #T30-11-B
 Model #T30-WH-B

Use and Care Guide Tri-view Bath Storage Cabinet

TOOLS REQUIRED



Claw hammer



Safety goggles

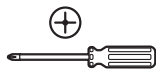

Phillips screwdriver

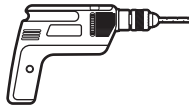

Power drill

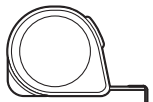

Measuring tape

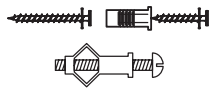

Wall hardware



Level

HARDWARE INCLUDED (depending on model)



AA - Shelf Clip
 x 8

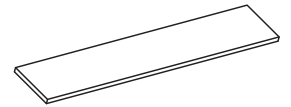

BB - Shelf
 x 2

Installation

1 DETERMINING THE MOUNTING LOCATION



NOTE: Before installing, make sure all parts are present. Compare parts with the Hardware Included list. If any part is missing or damaged, do not attempt to install the product.

- Determine the desired mounting location, and mark the wall where the unit will be installed.

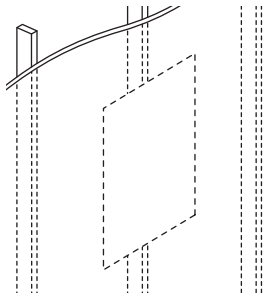

2 PRE-DRILLING THE BACK OF THE CABINET

- Drill 1/8 in. diameter holes through the back panel of the cabinet

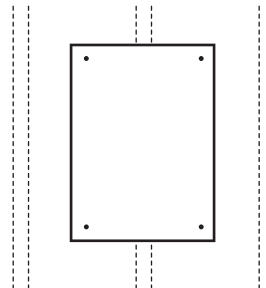

3 INSTALLING THE CABINET

- For wall stud installation, insert #12 x 3 in. screws with washers into the stud locations (not included).
- For drywall installation, drill holes at the appropriate locations and insert toggle bolts with washers (not included).
- For concrete wall installation, drill 1/4 in. holes at the appropriate locations and insert #12 wall anchors, followed by #12 x 3 in. screws (not included).

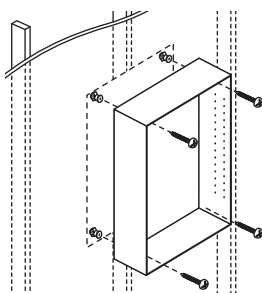
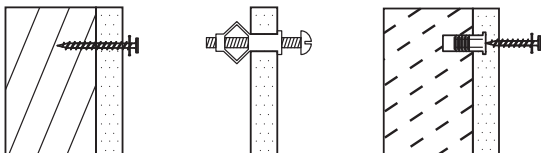

4 INSTALLING THE SHELVES

- Insert the provided shelf clips into the holes on the inside of the cabinet.
- Rest the shelf on the shelf clips.

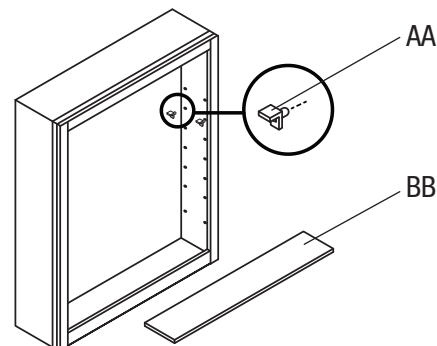

Safety Information

Please read and understand this entire manual before attempting to assemble, operate, or install the product.

Care and Cleaning

- Use a water-dampened cloth to clean the bath storage cabinet frame.
- For the mirrors, use ammonia-free cleaning products.

Warranty

LIMITED WARRANTY

WHAT IS COVERED

The manufacturer warrants its parts and products to be free of substantial defects in materials and workmanship from the original date of purchase under normal home use. This warranty is offered only to the original consumer purchaser and may not be transferred.

Coverage for the Medicine or Bath Storage Cabinet Body is for the lifetime of the product.

Coverage for Medicine Cabinet and Bath Storage parts (mirrors, doors, hinges and shelves) lasts for five years from the original date of purchase.

During the warranty period, the manufacturer, at its option, will repair or replace any part or product that proves to have substantial defects in materials or workmanship, or the manufacturer will provide an equivalent replacement product. In keeping with our policy of continuous product improvement, the manufacturer reserves the right to change specifications in design and materials without notice and with no obligation to retrofit products we previously manufactured.

This warranty gives you specific legal rights, and you may also have other rights that vary from state to state.

Because of the varying natural characteristics of wood and the effects of aging, product shown in displays and/or printed materials will not be an exact match to new cabinetry you will receive. Depending on the wood characteristics, the age of a sample and the environment of the showroom, samples will show some degree of variation from new product. In addition, you should not expect all doors, drawer fronts, trim or molding to match exactly in either finish or grain. Variation in wood is normal and unavoidable. In addition, it is not possible to exactly match our colors in printed materials. Therefore, you should view the actual samples when making your color selection.

WHAT IS NOT COVERED

This warranty does not cover any problems or damage which result from improper transportation, improper installation, mishandling, misuse, abuse, neglect, abnormal use, commercial use, improper maintenance, non-manufactured repairs, accidents, or acts of God, such as hurricanes, fire, earthquakes or floods. This warranty and any applicable implied warranties do not cover incidental or consequential damages arising from any defects in the product, such as labor charges for installation or removal of the product or any associated products. This warranty does not cover defects or damage caused by normal wear & tear, alterations, environmental conditions, humidity absorption, or mold. In addition, variations in wood grain, finish color, aging or other natural wood and stain characteristics are not considered defects and are not covered by this warranty. Some states do not allow the exclusion or limitation of incidental or consequential damages, so the above limitation or exclusion may not apply to you.

THE MANUFACTURER DISCLAIMS ANY IMPLIED WARRANTY INCLUDING, WITHOUT LIMITATION, ANY IMPLIED WARRANTY OF MERCHANTABILITY, AND THERE ARE NO WARRANTIES THAT EXTEND BEYOND THE DESCRIPTIONS ON THE FACE HEREOF. TO THE EXTENT THAT SUCH DISCLAIMER IS NOT VALID UNDER APPLICABLE LAW, ANY IMPLIED WARRANTY SHALL BE COEXTENSIVE IN DURATION WITH THIS WARRANTY.

Products should be examined for defects prior to installation. This warranty does not cover labor charges for installation or removal of the product or any associated products. If upon inspection you find our product has a damaged or missing part, it may not be necessary to return the unit to the store of purchase. Please contact customer service to obtain a replacement part.

If you need replacement parts or would like to make a warranty claim, please contact customer service at 1-888-774-8062. All warranty claims must include the model number of the product, copy of the original receipt and the nature of the problem. In addition, the manufacturer may at its discretion require inspection of the installation site or authorize the prepaid return of the claimed defective part. Merchandise not pre-approved for return will not be accepted and the associated claim not accepted.