

Single Pole Humidity Sensor and Fan Controller

Cat. No. IPHS5 - INDOOR USE ONLY
 120VAC, 60Hz - Single Pole Only
 Incandescent: 600W - MLV/Fluorescent: 400VA - LED/CFL: 150W - Fan: 1/6Hp
INSTALLATION INSTRUCTIONS

WARNINGS AND CAUTIONS:

- **TO AVOID FIRE, SHOCK, OR DEATH: TURN OFF POWER AT CIRCUIT BREAKER OR FUSE AND TEST THAT THE POWER IS OFF BEFORE WIRING!**
- **TO AVOID PERSONAL INJURY OR PROPERTY DAMAGE, DO NOT** install to control a receptacle, or a load in excess of the specified rating.
- To be installed and/or used in accordance with electrical codes and regulations.
- If you are not sure about any part of these instructions, consult an electrician.

WARNINGS AND CAUTIONS:

- Clean outer surface gently with damp cloth only. **DO NOT** use soaps or cleaning liquids.
- No user serviceable components. **DO NOT** attempt to service or repair.
- Use this device **WITH COPPER OR COPPER CLAD WIRE ONLY.**

A TOOLS NEEDED TO INSTALL YOUR DEVICE

- | | | |
|------------------------------|-----------------|--------|
| Slotted/Phillips Screwdriver | Electrical Tape | Pliers |
| Pencil | Cutters | Ruler |

B DESCRIPTION

The IPHS5 is a humidity sensor and switch for control of bath fans and combination bath fan/lights. The IPHS5 detects changes in humidity for control of condensation in bathroom application or house ventilation. It is compatible with bath fans rated at 1/6th HP and fan/light combinations with single switched load.

C FEATURES

- Compatible with Incandescent, LED, CFL and Fluorescent loads when used with combination fan & light fixtures.
- Sensitivity adjustment.
- Built in countdown timer feature for manual operation.
- Automatic ventilation/air circulate mode for continuous operation with hourly pre-set time outs.

D LOCATION / MOUNTING

For bathroom applications the device should be placed at a level to detect steam. Placing the detector directly above a heater or near drafts is not recommended.

NOTE: DO NOT use to control a fan/light combination where this is the only means of illumination.

E CHANGING THE COLOR OF YOUR DEVICE

Your device may include color options. To change color of the face proceed as follows:

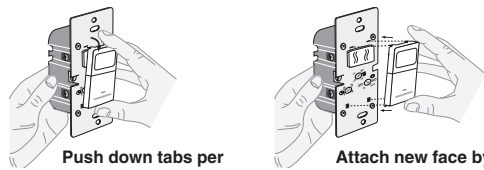

Push down tabs per diagram, one at a time and rotate forward to release

Attach new face by inserting bottom hinge tabs, then pivot and snap the color change kit to attach

INSTALLING YOUR DEVICE

NOTE: Use check boxes when Steps are completed.

Step 1 WARNING: TO AVOID FIRE, SHOCK, OR DEATH; TURN OFF POWER at circuit breaker or fuse and test that power is off before wiring!

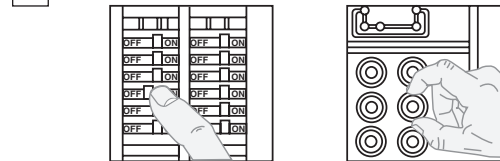

Step 2 Identifying your wiring application (most common):

NOTE: If the wiring in the wall box does not resemble this configuration, consult an electrician.

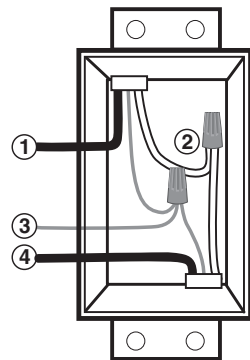

Single-Pole

1. Line (Hot)
2. Neutral
3. Ground
4. Load

Step 3 Preparing and connecting wires:

This device can be wired using side wire terminal screws or back wire openings. Choose appropriate wire stripping specifications accordingly.

TO SIDE WIRE:

Side wire terminals accept #14-12 AWG solid and stranded copper wire.

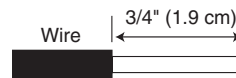

TO BACK WIRE:

Back wire openings use #14-12 AWG solid copper wire only.

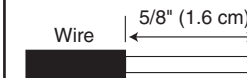

- Make sure that the ends of the wires from the wall box are **straight (cut if necessary)**.
- Strip conductors 3/4" (1.9 cm) for side wire applications or 5/8" (1.6 cm) for back wire applications.
- **Go to Step 4 for wiring instructions.**

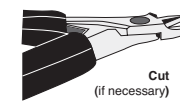

Step 4 Installation:

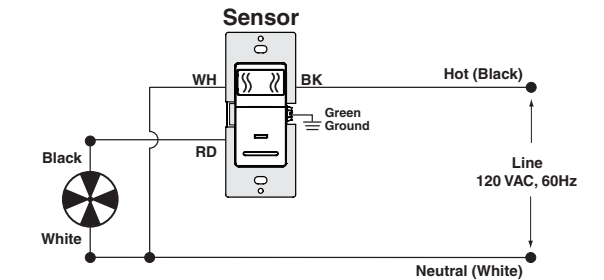
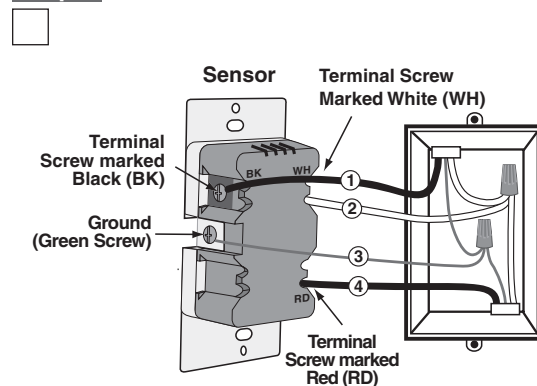

WIRING SENSOR:

Connect wires per WIRING DIAGRAM as follows:

- Green or bare copper wire in wall box to Green terminal screw.
- Line Hot wall box wire to terminal screw marked "BK".
- Load/fan wall box wire to terminal screw marked "RD".
- Neutral wall box wire to terminal screw marked "WH".
- **Proceed to Step 5.**

Step 5 Testing your Device prior to Mounting in Wall Box:

NOTE: Dress wires with a bend as shown in diagram in order to relieve stress when mounting device.

- Position all wires to provide room in outlet wall box for device.
- Ensure the word "TOP" is facing up on the device strap.
- Partially screw in mounting screws in the wall box mounting holes.
- Restore power at the circuit breaker or fuse.
- The Locator LED in the center of the push pad should be illuminated and not blinking. Refer to **Locator Light Status Chart** to confirm operational state of device.
- Press and release push pad – This will turn ON the load/fan and activate the internal countdown timer. The load/fan will turn OFF after the set time out expires.
- Press and release the push pad again to manually turn OFF the load/fan.

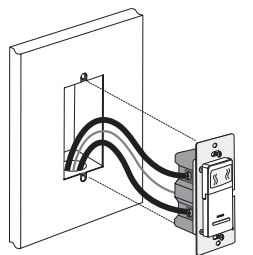

LIMITED 5 YEAR WARRANTY AND EXCLUSIONS

Leviton warrants to the original consumer purchaser and not for the benefit of anyone else that this product at the time of its sale by Leviton is free of defects in materials and workmanship under normal and proper use for five years from the purchase date. Leviton's only obligation is to correct such defects by repair or replacement, at its option. **For details visit www.leviton.com or call 1-800-824-3005.** This warranty excludes and there is disclaimed liability for labor for removal of this product or reinstallation. This warranty is void if this product is installed improperly or in an improper environment, overloaded, misused, opened, abused, or altered in any manner, or is not used under normal operating conditions or not in accordance with any labels or instructions. **There are no other or implied warranties of any kind, including merchantability and fitness for a particular purpose, but if any implied warranty is required by the applicable jurisdiction, the duration of any such implied warranty, including merchantability and fitness for a particular purpose, is limited to five years. Leviton is not liable for incidental, indirect, special, or consequential damages, including without limitation, damage to, or loss of use of, any equipment, lost sales or profits or delay or failure to perform this warranty obligation.** The remedies provided herein are the exclusive remedies under this warranty, whether based on contract, tort or otherwise.

DIAL SETTINGS

With the power restored and the wallplate removed, remove the face of the device to expose the setting controls (see **Color Change Kit removal on page 1**). Use a small screwdriver to make adjustments to the device as required for the application.

Time - factory default is 10 minutes (1)

- Adjust the time selector to set the time out duration, which is the minimum desired length of time the load/fan will remain ON after being turned on in any mode of operation.
- Refer to Sensors Dials chart for available time period options.
- For use with all three Automatic Modes of Operation.

Sensitivity - To reduce false activation, reduce sensitivity.

- Hi** - Default Setting.
- Medium**
- Low**
- OFF** - used in Air Cycle mode.

Humidistat – factory default is OFF (off)

- OFF - device ignores the humidity set point and controls load/fan based on detection of excess humidity.
- Minimum relative humidity set point may be set between 20% and 80% - sets the ambient humidity threshold below which the load/fan must be operated manually and/or above which the load/fan will be operated according to one of the automatic modes of operation.
- Cycle - Only used in Air Cycle Mode.

SENSOR DIALS

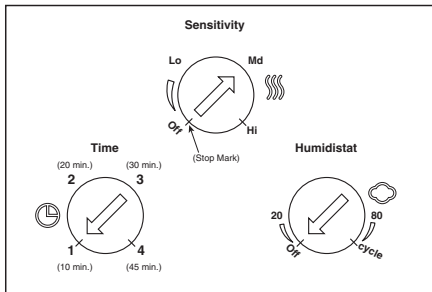

NOTE: DO NOT rotate the adjustment dials past the stop marks shown in the figure above.

LOCATOR LIGHT STATUS

| Locator Light Status Chart | |
|-----------------------------------|--------------------------|
| LED | Status |
| ON | Fan (load) OFF |
| OFF | Fan (load) ON |
| Blinking 2 sec. ON, 2 sec. OFF | Air Cycle Mode is active |
| Blinking 2 sec. ON, 1/10 sec. OFF | Manual override |

MODES OF OPERATION

1. Automatic ON/Automatic OFF (Factory Default Mode)

The device is pre-set at the factory to turn ON the load/fan when excess humidity is detected. The load/fan will turn OFF after the humidity level declines to an acceptable level and the time out has expired. To set the device back to this factory default mode:

- Remove the face of the device to access the adjustment dials. Refer to Section E on the front page of these instructions.
- Rotate the Humidistat dial counter clockwise to OFF.
- Rotate the Sensitivity dial to Hi (default setting). Set to Hi in large rooms or to increase the sensitivity of the device. Set to Lo in small rooms or to minimize false activation.
- Rotate the Time dial to the number 1 for the default time out of 10 minutes or to the number corresponding to the minimum desired length of time you wish the load/fan to stay ON once it is turned on in any mode of operation. Refer to Sensors Dials chart for available time out options.
- Re-attach the face of the device. Refer to Section E on the front page of these instructions.

2. Automatic ON/Automatic OFF Mode with humidity set points

The device will automatically turn ON the load/fan only upon detection of excess humidity above the minimum relative humidity set point:

- Remove the face of the device to access the adjustment dials. Refer to Section E on the front page of these instructions.
- Rotate the Humidistat dial between 20% and 80% to set the minimum relative humidity set point.
- Rotate the Sensitivity dial to Hi, Md, or Lo. Set to Hi in large rooms or to increase the sensitivity of the device. Set to Md in mid sized rooms. Set to Lo in small rooms or to minimize false activation.
- Rotate the Time dial to the number 1 for the default time out of 10 minutes or to the number corresponding to the minimum desired length of time you wish the load/fan to stay ON once it is turned on in any mode of operation. Refer to Sensors Dials chart for available time out options.
- Re-attach the face of the device. Refer to Section E on the front page of these instructions.

3. Air Cycle Mode

Provides pre-set ventilation ON time for meeting ventilation codes. After the initial ON time is set by manually turning ON the load/fan with the push pad the device will provide continuous ON/OFF time every hour. The length of time that the device will remain ON is determined by the Time dial setting. To set the device to operate in this mode:

- Manually turn the device OFF with the push pad if it is ON or wait for the device to time out automatically.
- Remove the face of the device to access the adjustment dials. Refer to Section E on the front page of these instructions.
- Rotate the Humidistat dial clockwise to the Cycle setting.
- Rotate the Sensitivity dial to the OFF position.
- Rotate the Time dial to the number 1 for the default time out of 10 minutes or to the number corresponding to the minimum desired length of time you wish the load/fan to stay ON each time it cycles.
- Re-attach the face of the device. Refer to Section E on the front page of these instructions.
- Press the push pad to manually turn the load/fan ON and set the initial ON time. The device will cycle ON every hour after the initial ON time is set and remain ON for the length of time set with the Time dial.

NOTE: pressing the push pad while the load/fan is ON in this mode will manually turn OFF the load/fan and deactivate the Air Cycle mode. To re-activate Air Cycle mode manually turn ON the load/fan with the push pad which sets a new initial ON time.

| | Modes of Operation | Dials | | |
|---|---|-------------------|------------------|------|
| | | Humidistat | Sensitivity | Time |
| 1 | Auto ON/Auto OFF | OFF | Low, Med or High | Any |
| 2 | Auto ON/Auto OFF W/ Humidity Set Points | Between 20 and 80 | Low, Med or High | Any |
| 3 | Air Cycle | Cycle | OFF | Any |

MANUAL OPERATION

At any time the device can be manually controlled with the push pad on the front of the device just below the Locator Light.

1. Manual Operation in Auto ON/Auto OFF

Manual ON - When manually turned ON with the push pad in this mode, and unless the device enters automatic operation by detecting excess humidity thereafter, the device will time out and turn OFF based on the time out setting. If the device has been manually turned on and excess humidity is detected before the time out period has lapsed, the device will override manual operation and assume control in automatic mode, turning the load/fan OFF after the humidity level declines to an acceptable level.

Manual OFF - At any time the push pad can be pressed to manually turn the load/fan OFF.

2. Manual Operation in Auto ON/Auto OFF with humidity set points

Manual ON - When manually turned ON with the push pad in this mode, and unless the device enters automatic operation by detecting excess humidity above the humidity set point thereafter, the device will time out and turn OFF based on the time out setting. If the device has been manually turned on and excess humidity is detected above the humidity set point before the time out period has lapsed, the device will override manual operation and assume control in automatic mode, turning the load/fan OFF after the humidity level declines to an acceptable level.

Manual OFF - At any time the push pad can be pressed to manually turn the load/fan OFF.

3. Manual Operation in Air Cycle Mode

Manual ON - When manually turned ON with the push pad in this mode, setting the initial ON time, the device will time out and turn OFF based on the time out setting and continue to cycle ON every hour until it is shut OFF.

Manual OFF - Pressing the push pad when the load/fan is ON will disable the Air Cycle Mode until the load/fan is manually turned back ON.

Step 6



Device Mounting:
TURN OFF POWER AT CIRCUIT BREAKER OR FUSE.

Installation may now be completed by tightening mounting screws into wall box. Attach wallplate.

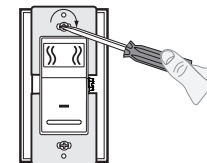

Step 7



Restore Power: Restore power at circuit breaker or fuse.

Installation is complete.

TROUBLESHOOTING

Load/fan does not turn ON in the presence of humidity (e.g. after a shower):

- If the sensor is installed in a high humidity area it may be necessary to adjust the humidistat settings.

Load/fan turns ON throughout the day:

- Change sensor's mode of operation to desired setting.

Load/fan turns ON and OFF during a shower:

- This is normal operation for rooms with good ventilation.

NOTE: DO NOT use to control a fan/light combination where this is the only means of illumination.

NOTE: The Leviton humidity sensor and fan control will not eliminate condensation and must be used with a properly sized ventilation fan in an enclosed space.

For additional information, contact Leviton's Techline at 1-800-824-3005 or visit Leviton's website at www.leviton.com

FCC COMPLIANCE STATEMENT

This device complies with Part 15 of the FCC Rules. Operation is subject to following two conditions: (1) this device may not cause harmful interference, and (2) this device must accept any interference received, including interference that may cause undesired operation of the device.

This equipment has been tested and found to comply with the limits for a Class B Digital Device, pursuant to Part 15 of the FCC Rules. These limits are designed to provide reasonable protection against harmful interference in a residential installation. This equipment generates, uses, and can radiate radio frequency energy and, if not installed and used in accordance with the instructions, may cause harmful interference to radio communications. However, there is no guarantee that interference will not occur in a particular installation. If this equipment does cause harmful interference to radio or television reception, which can be determined by turning the equipment OFF and ON, the user is encouraged to try to correct the interference by one or more of the following measures:

- Reorient or relocate the receiving Antenna.
- Increase the separation between the equipment and the receiver.
- Connect the equipment into an outlet on a circuit different from that to which the receiver is connected.
- Consult the dealer or an experienced radio/tv technician for help.

FCC CAUTION

Any changes or modifications not expressly approved by Leviton Manufacturing Co., Inc., could void the user's authority to operate the equipment.

FOR CANADA ONLY

For warranty information and/or product returns, residents of Canada should contact Leviton in writing at **Leviton Manufacturing of Canada Ltd to the attention of the Quality Assurance Department, 165 Hymus Blvd, Pointe-Claire (Quebec), Canada H9R 1E9** or by telephone at **1 800 405-5320**.