



# ALUMINUM DOCK

## QPF-495

(# 21519)

This manual will guide you through the steps to complete this project. Please read the instructions carefully to ensure that the assembly is carried out correctly and safely. To do so, please respect the following:

- > Make sure all bolts and nuts are bolted in properly.
- > Do not modify this dock system beyond the recommendations described in this guide as any alteration or repair will void the warranty.
- > Wear safety glasses, gloves and work boots when assembling the dock.
- > Keep children and pets away while assembling your dock.
- > The load capacity of this structure is limited to 4 people or 800 lbs (363 kg).

Should you encounter any difficulties with this product, please contact our Customer Service **1-800-585-1237** or email us at [info@multinautic.com](mailto:info@multinautic.com)

Assembly and  
Installation  
Guide





# REQUIRED MATERIAL

Box Content (product # 21519, 5 ft x 10 ft QPF-495 Dock Section)

## PARTS TO ASSEMBLE



## BOLT KITS



## Multinautic® Products to complete a Stationary, Rolling or Floating Dock Layout



## Required Tools for Frame Assembly and Accessories

Multi-bit screwdriver  
Wrench and ratchet with 7/16", 9/16" and 3/4" sockets  
Cordless drill with 3/16", 1/4", 5/16", 9/16" drill bits and square bit #2

## Required Tools to build the Decking

Tape Measure  
Pen  
Wood saw  
Cordless drill with 7/16", 1/4", 11/64"

## LAYOUT TYPES

The QPF-495 model is an aluminum dock that combines the most popular features. It is sturdy, modular, easy to assemble and light to handle. It is suitable for installation on piles, wheels or floats, and you can choose the freeboard (height of the dock in relation to the water) by installing 8" or 16" thick floats. Its configuration can evolve according to your needs and it can easily be expanded or modified over the years. If you haven't yet decided on the type of installation that will best suit your shoreline and your activities, here are a few suggestions to help you choose.

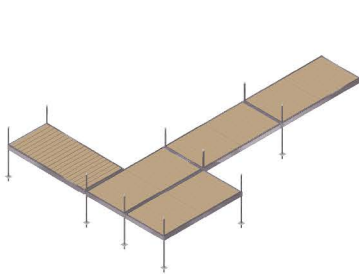

### STATIONARY DOCK

- 1 This is the ideal option for shallow water. You can install a stationary dock in a maximum of about 4 feet of water otherwise installation will be difficult.
- 2 A stationary dock is recommended if bad weather causes waves of up to 3 feet. If this is the case, you will have to moor the boat away from the dock or use a boat lift.
- 3 A post (or stationary) dock is not recommended in a body of water that often fluctuates more than 2 feet in a short period of time. A floating dock would be more appropriate in this case, otherwise you may have to adjust the height of the dock several times during the season.
- 4 The stationary dock is usually installed without anchoring and you should not rely on it to keep your boat afloat during a storm, or to protect it from large waves created by other boats.

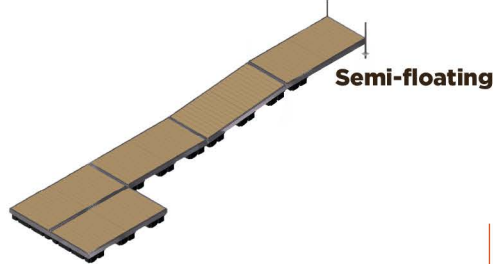

### SEMI-FLOATING DOCK

- 1 A semi-floating dock is required in a floating dock configuration. It has floats at one end only to allow for a smooth transition from land (or a fixed dock) to the floating dock.
- 2 If the bottom of the lake or river goes down quickly, start your configuration with a semi-floating dock. This will adjust with the water level.
- 3 If the lake or river bottom does not drop quickly, use fixed docks near the shore and then transition to the floating dock in deeper water. You will need a semi-floating dock section to make the transition between them.

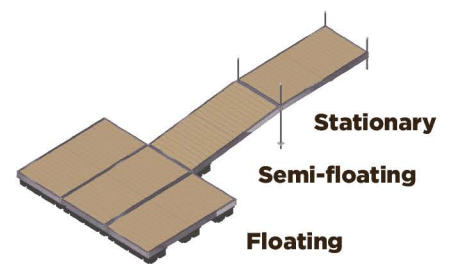

### FLOATING DOCK

- 1 A floating dock is recommended in bodies of water deeper than 4 feet.
- 2 A floating dock is ideal for lakes and rivers where the water level fluctuates periodically. Because the dock floats, it will always be at the same level above the water.
- 3 A floating dock is not recommended in a body of water that produces waves of more than 3 feet because it could be damaged or break and, at the same time, damage the boat moored to it.



A good way to help you make the right choice of installation is to look at your neighbours' docks. If they have been installed for a few years and are still in good condition, a similar choice could be good for you.

# CONFIGURATION

Now that you have determined your type of installation, you need to determine the location of your Dock Hinges before you start its assembly since they will likely be combined with other structural parts.

## DOCK HINGES

Plan the installation of your Dock Hinges by considering the diagrams shown beside.

The possible combinations are multiple. Whether end-to-end (**A**), parallel (**B**) or "L" shaped (**C**), Dock Hinges may be installed in combination with Corner Leg Holders and/or Fusion Plates.

To make the combination D, you will need 1/4" x 5/8" bolt sets and drill the aluminum with a 5/16" drill bit.

Whether your layout is on posts or floating, the first section will be placed on the ground with 2 posts.

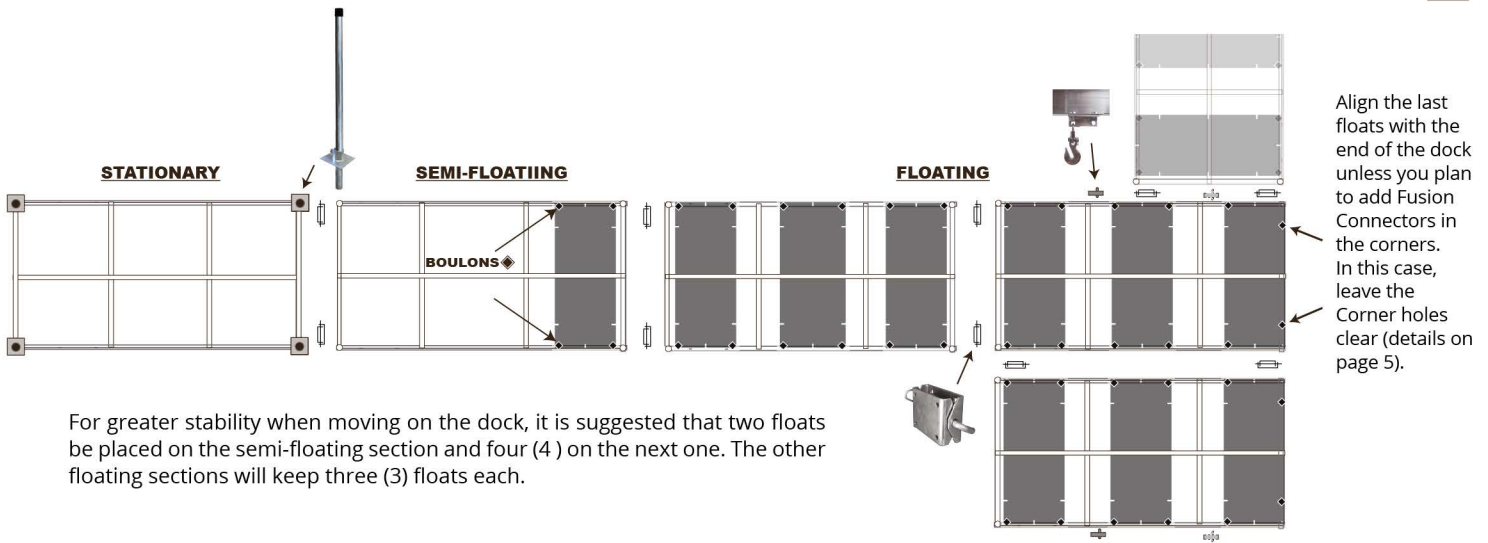
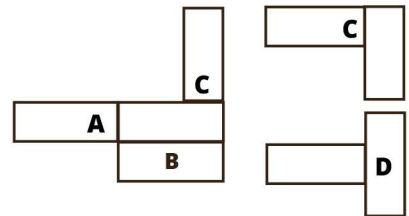

# STATIONARY DOCK

## POSTS AND BASE PLATES

- > To facilitate installation, the piles can be inserted into the Corner Leg Holders beforehand; once in the water, you will adjust them to the right height.
- > During installation, install the base plates on the posts, leaving about 6" (15 cm) underneath them (a little more if the lake bottom is muddy or a little less if it is a very hard bottom).
- > Drive the piles to the base plates by pressing with your foot on the base plate or by hitting the pile with a club.
- > Adjust the height of the dock and tighten the Leg Holder Set Screws securely.
- > Connect the second section to the first and so on.
- > Multinautic® 1 11/16" posts can be cut. Allow at least 16" (40 cm) to protrude above the dock for possible adjustments during the season.
- > Then install the protective caps.

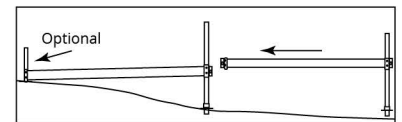

## DOCK WHEEL KIT

You can add one or more sets of wheels (product #22000) to facilitate removals and installations or to move the dock forward or backward according to changes in water level. We recommend anchoring a wheeled dock with blocks and chain since the piles will not be driven into the ground (see pair of Anchor Chain Hooks, product #22063, on page 5).



Position the parts to be assembled on the ground to visualize the steps to be followed. If you have decided to make a floating dock, assembly will be easier if the structure is mounted upside down, with the cleat track at the bottom. You will flip it up once the floats are bolted to proceed to DECKING assembly.

Combine the aluminum parts as shown below. Screw the nuts in by hand to begin and tighten when completed. If it is difficult to insert a bolt into a hole, you can enlarge it using a metal drill bit.

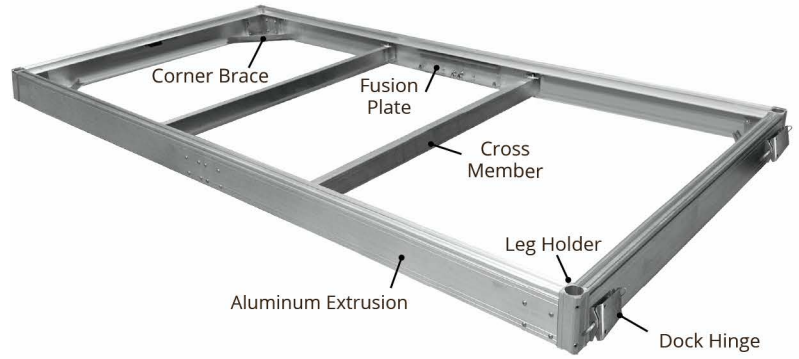

## 1 DOCK SIDES

Assemble the Aluminum Extrusions by inserting the Fusion Plates into the opening (A). Depending on the configuration you have planned, you will possibly combine Dock Hinges in this step.

Hexagonal  
3/8" x 1"  
x 8



Round head  
1/4" x 3/4"  
x 16

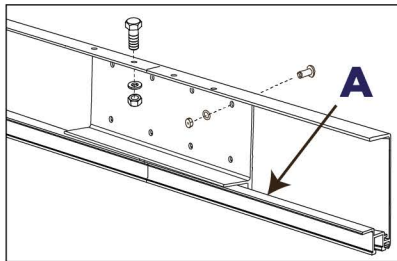

## 2 LEG HOLDERS

Insert the Leg Holders into the Side Extrusions and secure with the 1/4" x 2" Round Head Bolts. Install the Dock Hinges at the same time according to your configuration plan.

Round head  
1/4" x 2"  
x 32

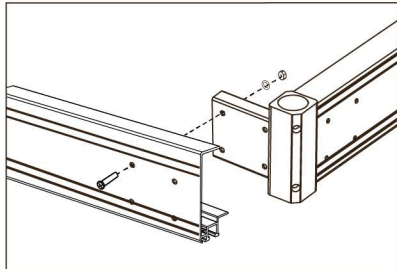

## 3 BRACES

Install the Diagonal Braces in the 4 corners and the Set Screws in the Leg Holders that will be used to retain posts if required.

Hexagonal  
3/8" x 1"  
x 8



Set Screws

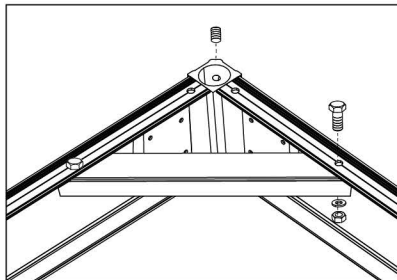

## 4 CROSS MEMBERS

Insert Connector Keys aligned with the holes for the cross Members and bolt on with 4 1/2" Hexagonal Bolts.

Connector  
Keys  
x 4



Hexagonal  
3/8" x 4-1/2"  
x 4

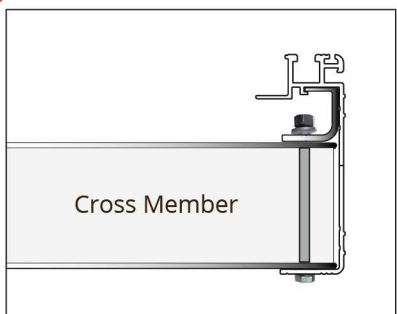





# FLOATING DOCK

## FLOATS

> This model of dock is sometimes sold as a pre-configured package, including a whole range of accessories, or by the unit, leaving the customer the possibility of installing it on piles, wheels or floats. We leave it up to each customer to drill the holes to bolt the floats if necessary. Rest assured, it is as easy to drill holes in aluminum as it is in hardwood. A metal drill bit matching the bolts used will do the job easily.

> We recommend 2 models of Multinautic® floats; the 24" x 60" x 8", for a dock close to the water (+/- 10" freeboard) and the 24" x 60" x 16", for a higher dock (+/- 18" above the water surface).

> The use of 3/8" x 3-1/2" galvanized steel hexagonal bolts for float installation is a wise choice. It is important to add large flat washers to protect the floats. Multinautic® offers a set of 12 bolts with washers (product #22203). A 7/16" drill bit is required.

Hexagonal Bolt	3/8" x 3 1/2"
Flat Washer	3/8"
Large Flat Washer	1 3/4" Dia.
Lock Washer	3/8"
Nut	3/8"

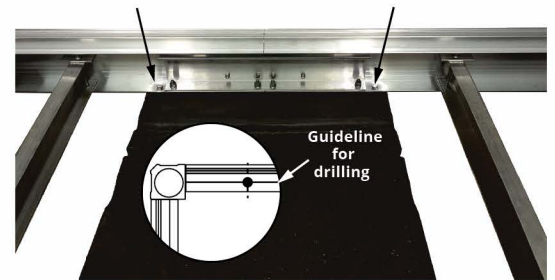
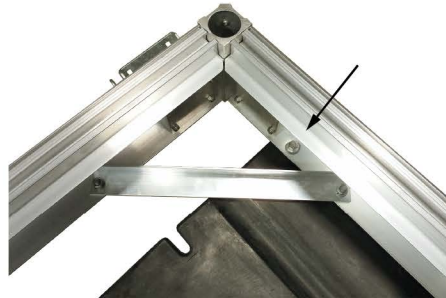

## ANCHOR CHAIN HOOKS

As indicated on the "Anchoring Suggestions" page, a floating dock requires concrete blocks that must be installed with chains, which must be attached to the dock with hooks.

Product #22063 includes 2 angle plates with hooks for attaching and easily adjusting anchor chains. Drill the required holes in the aluminum beam with a 9/16" drill bit for the 1/2" bolts included, in accordance with the anchoring recommendations on page 7.

## FUSION CONNECTORS

Fusion Connectors (product #21585) are designed to prevent the dock from opening and closing at the junction of 2 floating sections (under the action of waves or people) by immobilizing the dock hinges to create a more stable platform.

- > These stabilizers must not be installed on a semi-floating section.
- > They must be installed in combination with the dock hinges
- > This assembly is required to make a safe swimming raft.

After installation, be sure to tighten the Set Screws already placed in the Leg Holders. Check the bolts periodically.

**PLEASE VISIT OUR WEBSITE [MULTINAUTIC.COM](http://MULTINAUTIC.COM) TO LEARN HOW TO PREPARE YOUR DOCK FOR WINTERTIME.**

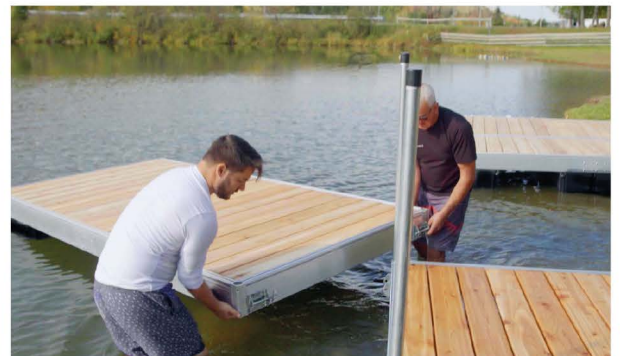





# DECKING

## REQUIRED MATERIAL for a 5' x 10' section

	Description	Quantity	
<b>a</b>	Girts	2" x 4" x 29"	2
<b>b</b>	Central Support	2" x 4" x 111"	1
<b>c</b>	Decking Supports	2" x 4" x 55"	6
<b>d</b>	Decking Planks	5/4" (1") x 6" x 56 3/4"	20
	Stainless Steel Screws	#12 x 3"	4
	Treated Wood Screws	#10 x 3"	10
	Treated Wood Screws	#8 (or #10) x 2"	150
	Stainless Steel Screws	#10 x 1 3/4"	12

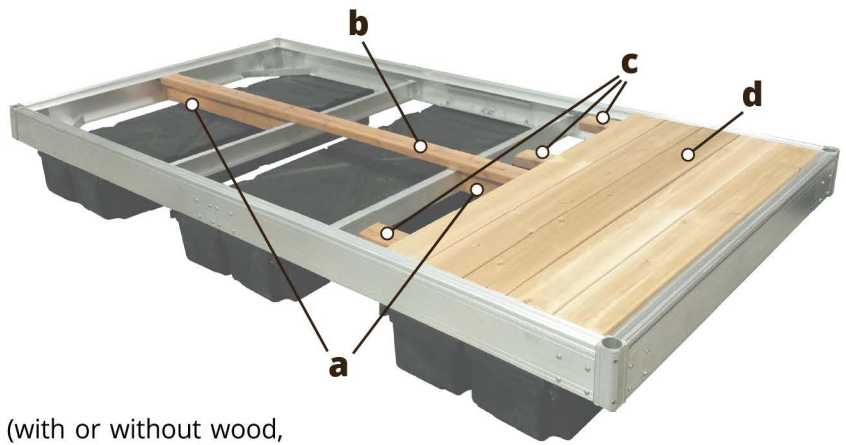

This dock model is offered in different types of packages (with or without wood, with or without floats, etc.) If decking is not included, this page shows you the sizes of materials required and the steps to follow. The cut-to-size red cedar decking kit has its own assembly guide.

**1** Girts (**a**) are installed in the center of the end extrusions with a Connector Keys. To do this, drill a hole, at 15/16" from one end, on each girt with a 7/16" drill bit. Be sure to drill very straight; make the hole in 2 steps: half from above and half from below. This way the holes will be straight in and out.

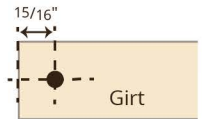

Install the Connector Key and insert the Girt in place. Since wood is a natural material, the 2" x 4" may be a little too tight, so to ease insertion, use a hammer to lightly crush the end. If, on the contrary, the end is not tight enough, add a washer between the wood and the Connector Key. Use the 4 1/2" bolts and tighten until the whole is well supported and not crushed.



**2** At the other end, attach the Girt (**a**) to the Aluminum Cross Member with #12 x 3" screws. Pre-drill the aluminum with a 1/4" drill bit, avoiding drilling through the wood. Repeat Step 1 and 2 with the other Girt.

**3** Place Central Support (**b**) on top and screw it onto the Girts with three wood screws of 3" per Girt, all properly aligned.

**4** You will assemble the 2 decking panels upside down and then turn them over. This way, you will not see the screw heads on the finished product. Place the Decking Planks (**d**) on the aluminum frame, their nice side down, all leaning on the same side.



**5** Place 4 Decking Supports (**c**) 2.5" from the sides and two more next to the Central Support (**b**), so as not to conflict with the Central Support. Before screwing into these decking supports (six 2" wood screws per plank), make sure that the spaces between the planks are equal and that the decking supports are positioned parallel to each other.

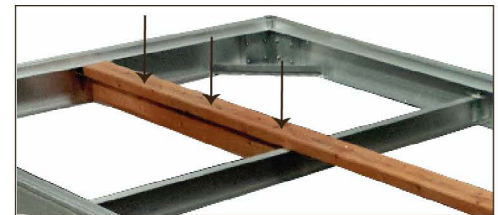

**6** Once assembled, turn the decking panels over. Drill a 11/64" hole in the corner of a panel, through the wood and the aluminum support lip and insert a #10 x 1 3/4" stainless steel screw. Do the same at the other end of the board and repeat the operation in the other 2 corners and in the center of the panel. Repeat the operation with the other decking panel.

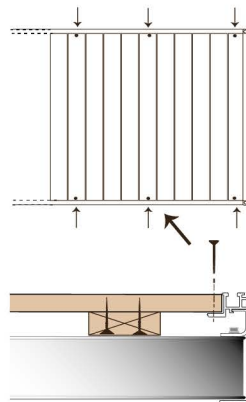
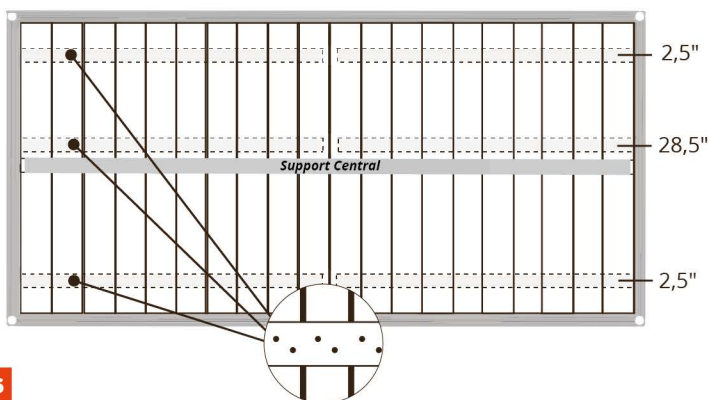





# ANCHORING SUGGESTIONS

These drawings, plans and/or technical specifications are only general information and can in no way replace, in whole or in part, certified engineering drawings. Please refer to the "Important information and disclaimer" section of our website.

## STATIONARY DOCK

Normally, it is not necessary to anchor a fixed dock except in areas where high waves may hit the dock. Posts driven into the ground will ensure its stability.

You should, however, moor your boat in such a way that it cannot rub or bump on the docks, thus protecting the structure and the boat.

> Since your dock is in shallow water, it will be easy for you to install blocks to allow for detached mooring from the dock (A).

> For more demanding conditions, you can add diagonal braces #22035 (B).

> Some will prefer the installation of a boat lift.

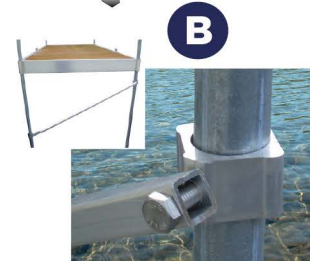
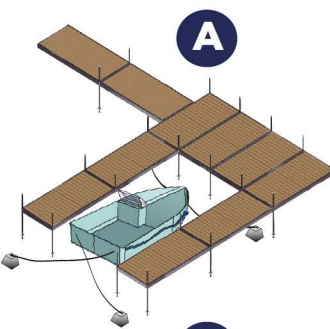

## FLOATING DOCK

A floating dock system is required to have anchor blocks at the end of the dock, or approximately every 30 feet. When the dock is subjected to lateral pressures created by water, wind or boats, the blocks hold the dock in place. You should evaluate their positioning to avoid interfering with docking or swimming. Chain hooks must be installed at each anchorage point.

> To launch them into the water, concrete blocks will be deposited and bundled on the floating dock section. To protect the dock surface, place a cardboard or piece of wood on the dock before placing the blocks.

> The chain will then be attached to the blocks (C). Calculate the width of the dock plus the depth for each chain to create the necessary "X", but do not cut it right away.

> Once your floating dock section is over the first location you have determined, you will tilt the group of blocks into the water (D). Beware of chain movements that will quickly follow the blocks as they fall!

> Then hook this chain to the attachment in the opposite corner without tension.

> Cut the chain, keeping an extra 2 ft. to allow for adjustments.

> Repeat the steps on the opposite side and this time tighten the chain as much as possible.



## ANCHORING MATERIAL

Your local concrete products dealer will probably have heavy enough weights to serve as anchors or they can make them for you from unused concrete. Be sure to comply with municipal by-laws regarding the use of concrete at the bottom of the water. You may have to choose a different material. Your hardware dealer will provide you with the necessary chain.

> Different types of soil, such as clay, can affect the stability of your anchors, so be careful. Muddy soil will provide a good grip for anchoring.

> The chain used to connect the blocks to the dock should be made of galvanized steel, size 5/16" and grade 30 (regular). Choose galvanized shackles for underwater fastening. Avoid zinc-plated quick links for this use.

> Blocks should weigh about 125 lbs. each and be rather square (+/- 1' x 1' x 1') to avoid movement on the bottom of the water (filling a bucket with cement is not a good idea since it will roll on the bottom of the water). If you make your own blocks, make an attachment point by placing a piece of chain with a bolt or a knot at its end for a better grip in the concrete.

> Note that the concrete will lose about one third of its weight once underwater. This is why we recommend as much (below).



## MINIMUM ANCHORAGE EXAMPLES IN CALM WATER AREAS

It's advisable to anchor the dock at the 4 corners of the section where the boats will be moored (E). If you plan to accommodate other boats during the season, estimate your needs accordingly.

- > Small boats under 15' such as canoes, kayaks, rowboats or personal watercraft, (maximum of 2 boats) at least 250 lbs. per chain, on each side;
- > Pleasure craft less than 19' or approximately 2500 lbs, (maximum of 1 boat) at least 375 lbs. per chain, on each side;
- > Pleasure boat less than +/- 23' or +/- 4000 lbs. for water skiing or wakeboarding, (maximum of 1 boat) at least 500 lbs. per chain, on each side;
- > Pontoon with a canvas roof, (which can catch in the wind), at least 650 lbs. per chain, on each side.

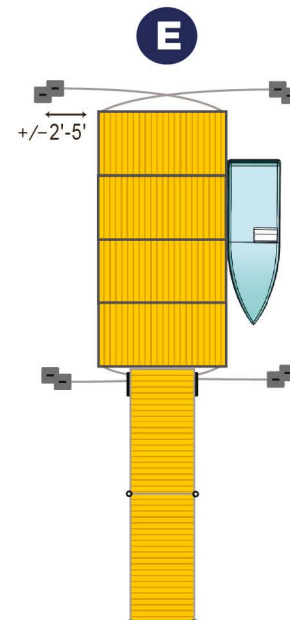

**WARNING**

These examples are intended to guide you as best as possible in planning your project. But some areas may require more anchors or a different method; we cannot list them all here. We cannot be held responsible for any incidents or damage that may occur as a result of using the techniques suggested in this document or on our website.





### Aluminum Dock Ladder 4 steps

- > 17 ¼ wide steps
- > 1 ½ in. tubular uprights
- > Resistance: can withstand a load of 400 lb (180 kg)
- > Stainless steel hardware included
- > Compatible with the extra step 15528 and the flip-up system 15529



15513 or 15524

### Quick Release Aluminum Ladder with «J» hook system, straight or angled, 3, 4 or 5 steps

- > 5.5 in. deep step
- > 1" square uprights perfect for children's little hands
- > Resistance: can withstand 250 lbs. (114 kg)
- > Stainless steel hardware included
- > Removes easily from the water thanks to its hook and loop system



### Large Selection of Mooring Accessories

- > Mooring cleats made of aluminum, nylon, galvanised or stainless steel
- > 100% nylon mooring ropes
- > PVC Bumpers for dockside, for corners, for posts...
- > Fenders and buoys...



### 30 in. Vertical Bumpers (2x)

- > Aluminum Mounting covered with White or black Big D PVC Bumper
- > Height-adjustable brackets
- > Perfect for post docks in the case of water level fluctuations
- > Add a pair of these bumpers in order to protect your boat and lower PWC



### LIMITED WARRANTY

Multinautic® hereby warrants to the original consumer purchaser only that this product will be free, in normal use, of any defects in materials and workmanship for a period of one (1) year from the consumer's original date of purchase directly from Multinautic® or from a Multinautic® authorized reseller (see Multinautic web site for specific warranty on floats). At its sole option, Multinautic® will repair or replace the defective product and promptly return it to you. In order for this warranty to be valid, the consumer must, at the time the product is returned, provide proof of purchase in the form of the original purchase receipt directly from Multinautic® or from a Multinautic®-authorized reseller. If Multinautic® elects to replace the defective product, then Multinautic® reserves the right to replace the defective product with another product of the same model or a model of at least comparable quality and features in Multinautic®'s sole determination. A reimbursement cannot exceed the amount paid by customer and is limited to the replacement of the defective product.

If you believe this product is defective within the warranty period, call Multinautic® for a Return Authorisation Number (RAN), carefully repack the unit, insure it and return it with proof of purchase, postage prepaid, to Multinautic® at 2330, Jean-Adam, St-Sauveur, QC, Canada, J0R 1R2. Write the RAN on the shipping label. Any product sent without RAN will be refused and returned freight collect to sender.

This warranty is not transferable. This warranty does not apply in cases of abuse or misuse of the product, use contrary to Multinautic®'s instructions, an act of God, negligent use, purchase from a party other than a Multinautic® authorized reseller, unauthorized repair, or modification of the product. ALL IMPLIED WARRANTIES OF MERCHANTABILITY OR FITNESS FOR A PARTICULAR PURPOSE ARE HEREBY DISCLAIMED TO THE EXTENT PERMITTED UNDER APPLICABLE LAWS AND, TO THE EXTENT NOT PERMITTED, ARE HEREBY LIMITED TO THE DURATION AND TERMS OF THIS WARRANTY. MULTINAUTIC® ALSO HEREBY DISCLAIMS ALL LIABILITY FOR INCIDENTAL, SPECIAL, OR CONSEQUENTIAL DAMAGES.

Some states or provinces do not allow limitations on how long an implied warranty lasts, or the exclusion or limitation of incidental or consequential damages, so the above limitation may not apply to you. This warranty gives you specific legal rights, and you may have other rights which vary from state to state or province to province. This warranty does not restrict the rights of the consumer mandated under applicable laws.

**SHOULD YOU ENCOUNTER ANY DIFFICULTIES WITH THIS PRODUCT, DO NOT RETURN IT TO THE STORE. PLEASE CONTACT OUR CUSTOMER SERVICE AT 1-800-585-1237 TOLL-FREE**