

# RHYTHM

A Weenote with wood-like sounding bars providing rhythmic sounds of Africa without the maintenance challenges of wood. Also a space saving design with movement-inspiring sound.

*C MAJOR DIATONIC*

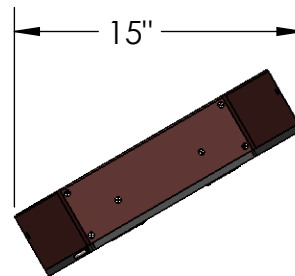
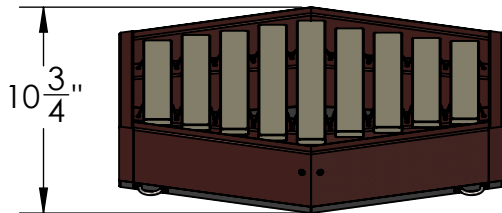
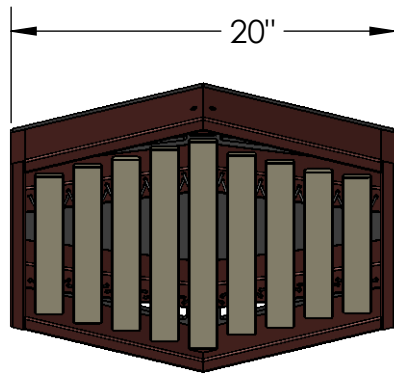
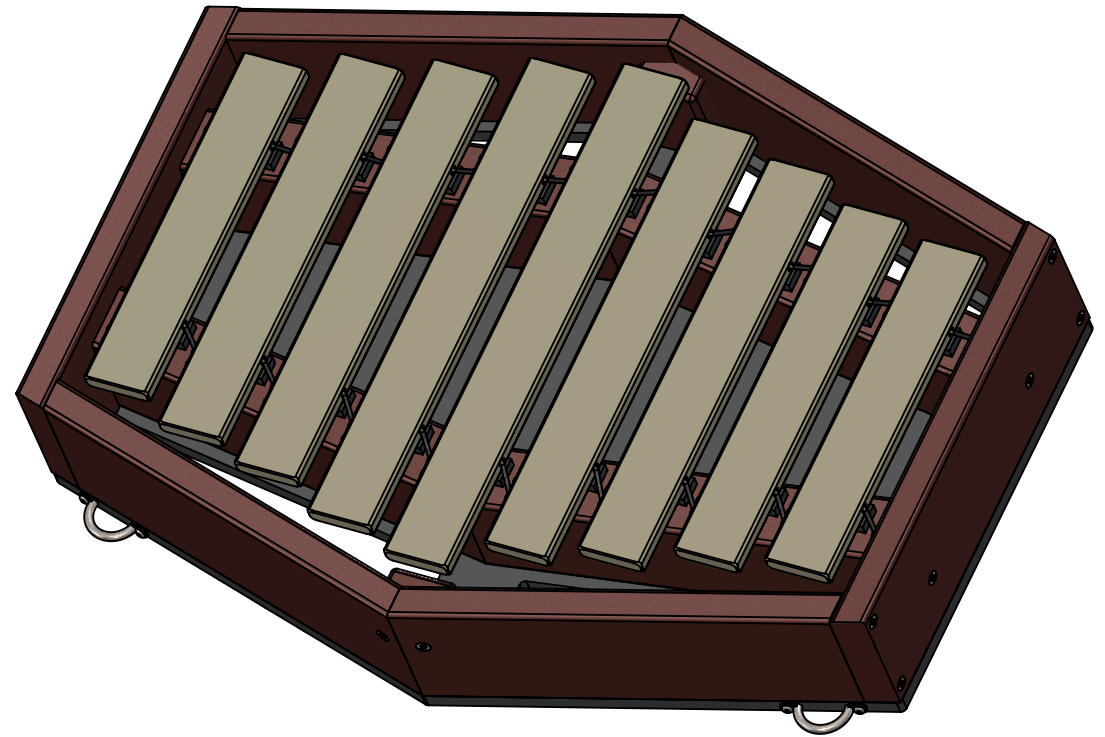

## MOUNTING OPTION IDENTIFICATION:

This instrument is offered with various mounting options. Identify your option below and follow installation instructions on the following sheets.

### Recycled Post In-Ground Sheet 3 of 5

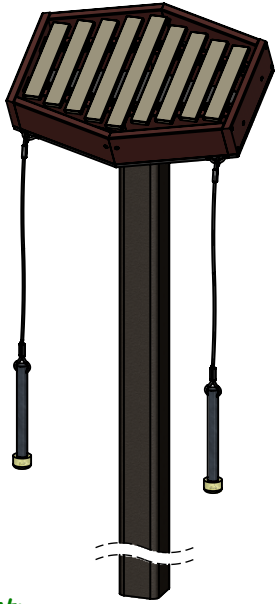

#### Parts List:

- Rhythm Instrument Assembly (1)
- In-Ground Post (1)
- 1 1/4" Tamper-Resistant Screw (5)
- Security Driver (1)
- Dual Drive #2 Screw (4)
- Holster

#### Weights:

Boxed Instrument Weight, 20 lbs.  
Boxed Post Weight, 36 lbs.

### Steel Post In-Ground Sheet 3 of 5

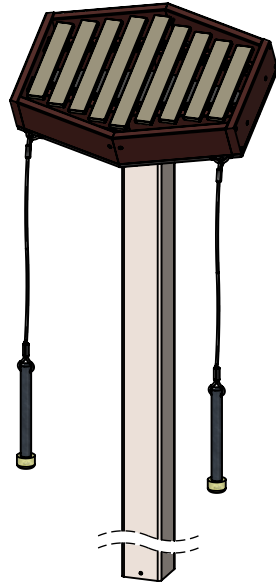

#### Parts List:

- Rhythm Instrument Assembly (1)
- In-Ground Post (1)
- 1" Tamper-Resistant Screw (5)
- 10-24 Tap (1)
- 11/64" Drill Bit (1)
- Security Driver (1)
- Dual Drive #2 Screw (4)
- Holster

#### Weights:

Boxed Instrument Weight, 20 lbs.  
Boxed Post Weight, 28 lbs.

### Recycled Post Surface Mount Sheet 4 of 5

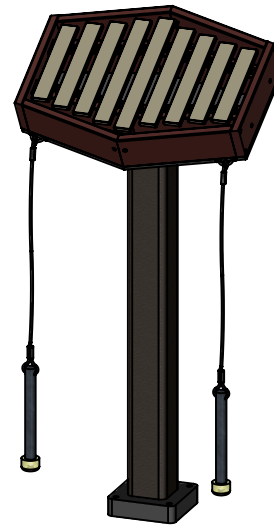

#### Parts List:

- Rhythm Instrument Assembly (1)
- Surface Mount Post (1)
- 1 1/4" Tamper-Resistant Screw (5)
- Security Driver (1)
- Ø 3/8" x 5" Anchor Bolt (4)
- Plastic Anchor Cap (4)
- Dual Drive #2 Screw (4)
- Holster

#### Weights:

Boxed Instrument Weight, 20 lbs.  
Boxed Post Weight, 35 lbs.

### Steel Post Surface Mount Sheet 4 of 5

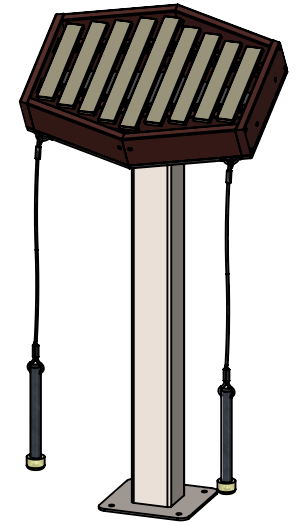

#### Parts List:

- Rhythm Instrument Assembly (1)
- Surface Mount Post (1)
- 1" Tamper-Resistant Screw (5)
- 10-24 Tap (1)
- 11/64" Drill Bit (1)
- Security Driver (1)
- Ø 3/8" x 3 3/4" Anchor Bolt (4)
- Plastic Anchor Cap (4)
- Dual Drive #2 Screw (4)
- Holster

#### Weights:

Boxed Instrument Weight, 20 lbs.  
Boxed Post Weight, 20 lbs.

## RECYCLED AND STEEL POST IN-GROUND INSTALLATION PROCEDURES

**Step 1:** Excavate one 10" diameter hole, 36" deep at the installation location. Contractor can modify post to desired height.

**Post Length = Frost Depth (36" Recommended) + Finished Height (Refer to Height Guideline)**

**Step 2:** Lower the post into the excavated hole.

**Step 3:** Refer to sheet 5 for installation of instrument to post.

**Step 4:** Verify the correct placement, levelness, plumbness, and finished height of the instrument. Also check for sufficient clearance around the instrument. A 36" radius is recommended around the instrument for wheelchair accessibility, however this is not required for instrument function. Instrument may be installed next to a wall or in a variety of different configurations.

**Step 5:** Last pour concrete around the post. It is recommended to brace the instrument to hold it rigid while the concrete cures. Leave to set according to the concrete manufacturers guidelines. Approximately (2) 80lb. bags will be needed.

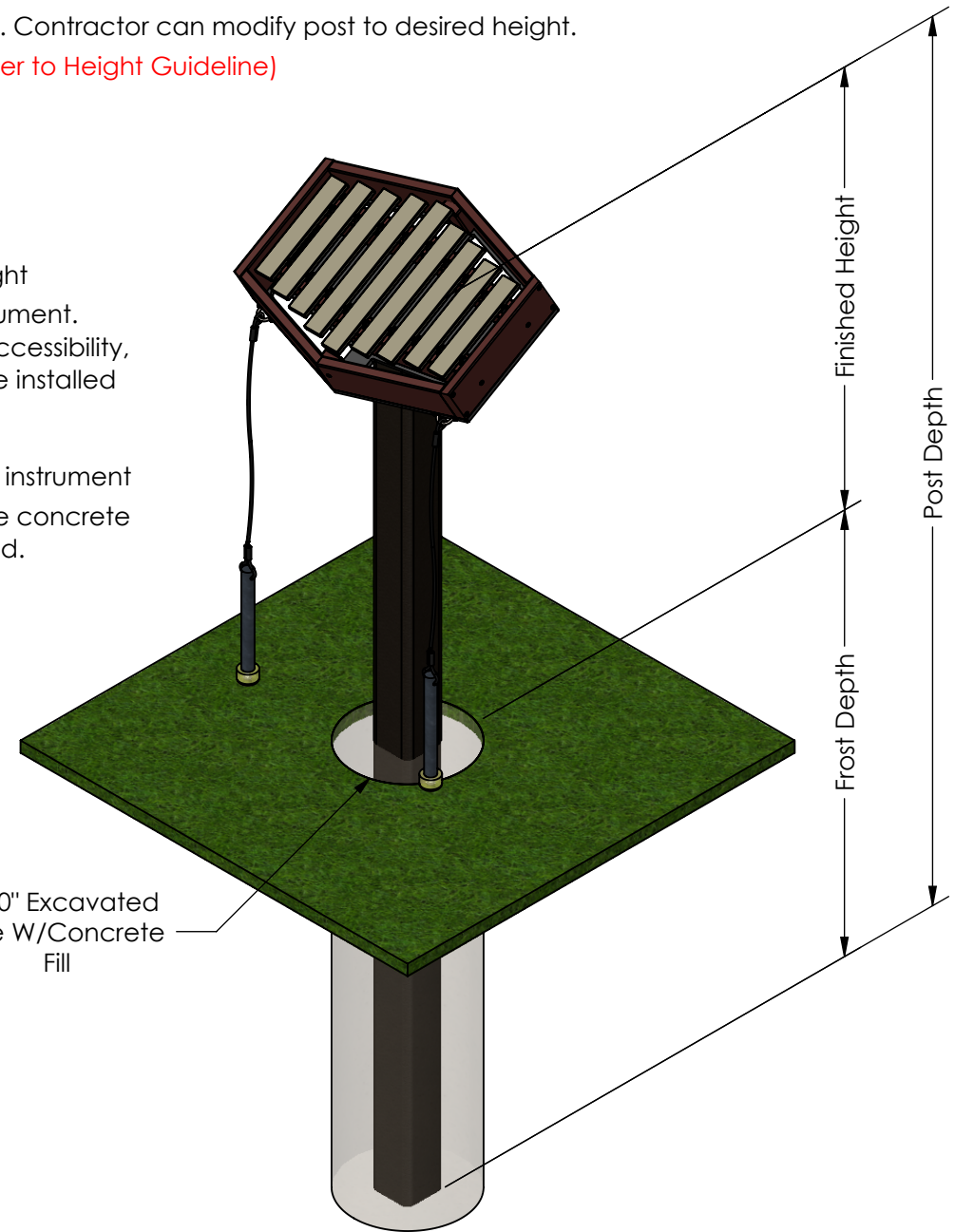

### FINISHED HEIGHT GUIDELINE

Ages 3-5, 22"  
Ages 5-7, 27"  
Ages 7-11, 32"  
Adult, 36"

Ø 10" Excavated  
Hole W/Concrete  
Fill

# RECYCLED AND STEEL POST SURFACE MOUNT INSTALLATION PROCEDURES

- Step 1:** Determine installation location. Verify concrete footing is a minimum of 6" thick. If the concrete pad is at an angle, steel washers are required to act as shims. (Shims not provided)
- Step 2:** Stand the surface mount post upright onto the concrete pad. Mark the center of the holes on the surface mount plate. After you have made your marks, set aside the post in order to drill for anchor holes. With a hammer or rotary drill, drill through concrete at marked locations. Drill to a minimum depth of 4". (A 3/8" masonry drill bit will be needed)
- Step 3:** Place the surface mounted post back over the drilled out holes. Insert provided anchor bolts into aligned holes. Position anchor nut so that it is flush with the top of the bolt. Pound anchor bolts into the hole until the anchor washer is flush with the post base. Tighten anchor bolts until they are snug. Cover remaining bolt sections with provided plastic caps.
- Step 4:** Refer to sheet 5 for installation of instrument to post.
- Step 5:** Verify the correct placement, levelness, plumbness, and finished height of the instrument. Also check for sufficient clearance around the instrument. A 36" radius is recommended around the instrument for wheelchair accessibility, however this is not required for instrument function. Instrument may be installed next to a wall or in a variety of different configurations.

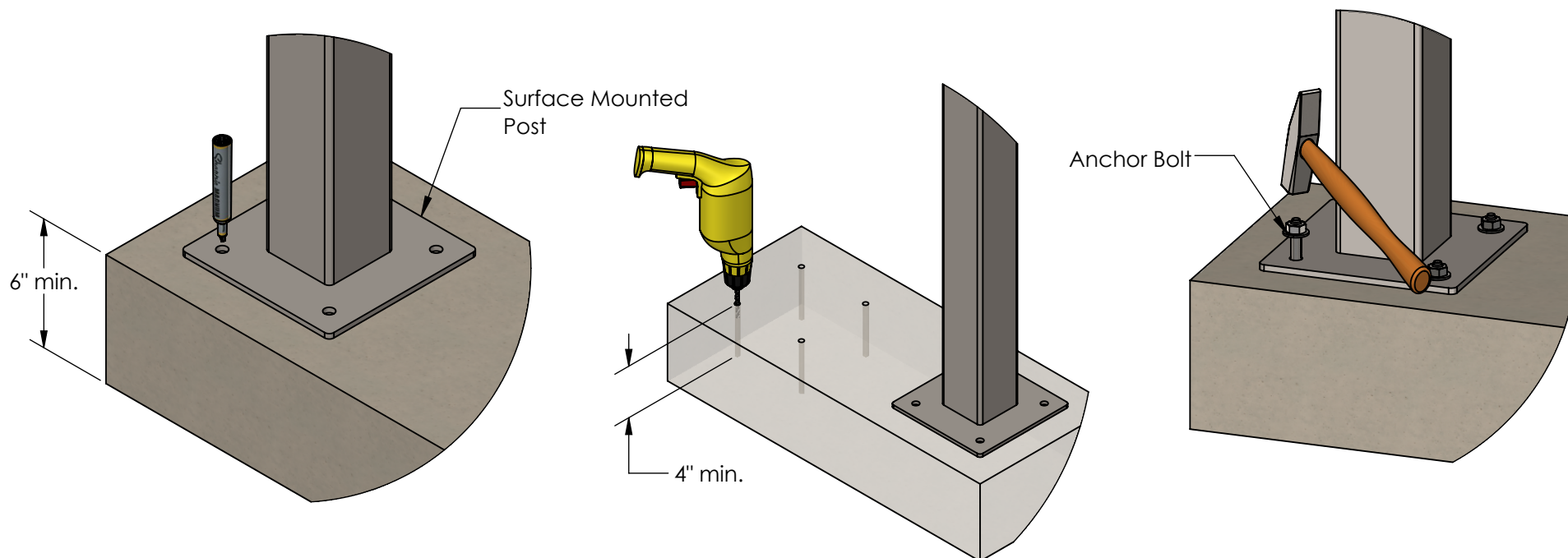

## HOLSTER AND INSTRUMENT TO POST INSTALLATION PROCEDURES

**Step 1:** Align Holster with instrument back with the corresponding arrows. Fasten Holster to back with the provided dual drive screws. Backs are predrilled. Screw heads should be flush with the Holster surface when properly installed. Holster must also be flush along the back. An extended square drive or Phillips will be needed. Drive screws in slowly to prevent stripping.

**Step 2: (Recycled Post Only)** With two people, situate the instrument onto the posts. Predrill 1/8" pilot holes into the posts through the existing holes on the instrument holster. Fasten the instrument to the posts with the provided 1 1/4" tamper-resistant screws and security driver.

**(Steel Post Only)** With two people, situate the instrument onto the posts. Predrill 1 1/64" pilot holes into the posts through the existing holes on the instrument holster. Next tap the holes with the provided 10-24 Tap, the Tap may be used with a cordless drill. Last fasten the instrument to the posts with the provided 1" tamper-resistant screws and security driver.

