

Bariatric 30.5" Seat Soaking Walk In Bathtub



355501L Left Hand Door and Drain



355501R Right Hand Door and Drain

Actual Size: 35" W x 55" L x 41" H
 Shipping Size: 36" W x 56" L x 44" H
 Shipping Weight: 330 lbs.
 Net Weight: 280 lbs.
 Water Capacity: 170 gal. US (unoccupied)
 90-150 gal. US (occupied)

Options:

- White or Biscuit Shell
- Left or Right Hand Door/Drain
- Air Massage
- Hydro Massage
- Dual Massage

Included Features:

1. Tub Shell - gel coat fiberglass
 - High quality fiberglass material
 - Excellent color uniformity
 - Durable gel coat surface
 - Easy-to-clean high gloss finish
2. Ergonomic door-sill with silicone rubber seal
3. Stainless Steel Frame
4. Built-in safety grab bar
5. Wall extension kit to fit in standard 60" opening
6. Removable access panels
7. Anti-slip floor
8. 5" Threshold
9. 17" Seat Height
10. 30.5" Seat Width
11. Five (5) Piece Huntington Brass Roman Faucet in Chrome
 - Jewel Arched Solid Brass Spout
 - 3/4" Valve, 3/4" Ports
 - Ceramic Disc Cartridges
 - Quick Connect Spout Installation
 - NPS Connections
 - 18 GPM (Average) @ 60 PSI

Plumbing:

- Two (2) 30" Supply Lines with 3/4" FIP connections
- +/- 5 minute 1 1/2" Quick Drain with overflow
- Drain opener with extension handle

Warranty:

- 25 Year warranty on tub body
- Lifetime warranty on door seal
- 5 Year on faucet*

*For more information please visit www.ellasbubbles.com.

Disclaimer:
 The walk-in bathtub comes without pre-drilled faucet holes. The faucet is installed by customer (contractor). The standard PVC pipe for drain overflow is measured, cut at the job site and supplied by customer (contractor).

Bariatric 30.5" Seat Soaking
Walk In Bathtub
355501L / 355501R
*Left hand door and drain shown

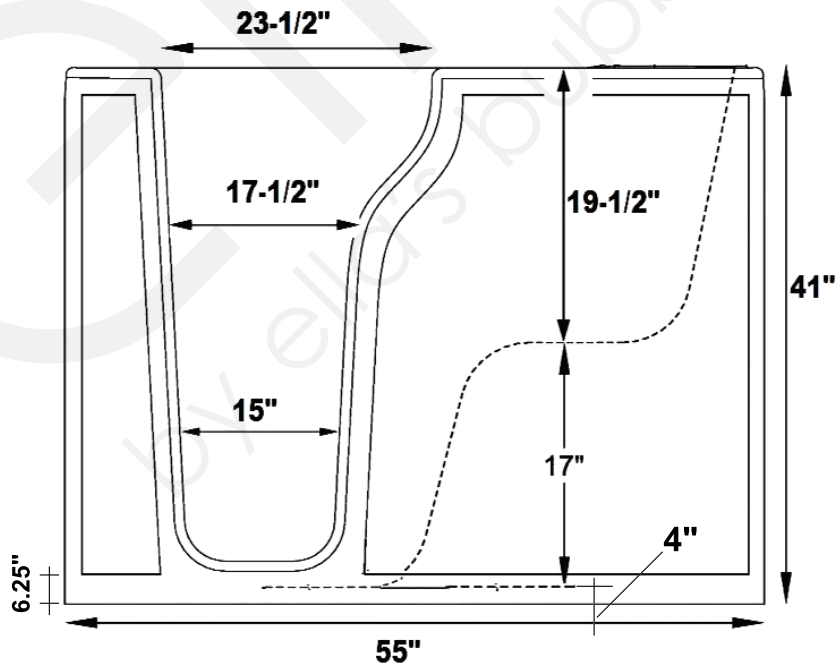
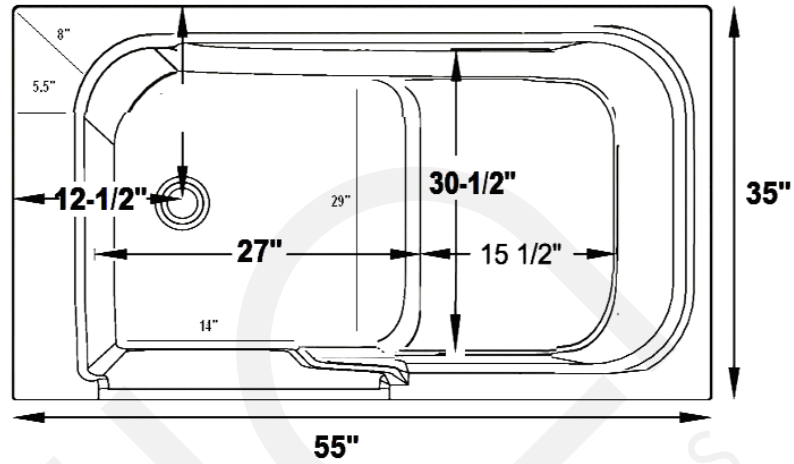

Disclaimer:
In an effort to continually improve our product, specifications and configurations are subject to change without notice. Before ordering or installing, consider future access to essential equipment.