

# FRIGIDAIRE

All about the

# Use & Care

of your

# Portable Air Conditioner

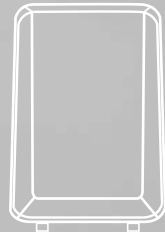

## TABLE OF CONTENTS

Important Safety Instructions .....	2-3	Air Conditioner Features .....	8
Product Registration .....	4	Operating Instructions .....	9-11
Normal Sounds .....	4	Care and Cleaning .....	11
Unit Description .....	5	Before You Call .....	12
Accessories Included .....	5	Major Appliance Limited Warranty .....	13
Installation Instructions .....	6-7		

# Important Safety Instructions

## NOTE:

This USE & CARE MANUAL provides specific operating instructions for your model. Use the Portable air conditioner only as instructed in this USE & CARE MANUAL. These instructions are not meant to cover every possible condition and situation that may occur. Common sense and caution must be practiced when installing, operating, and maintaining any appliance.

## NOTE:

The power supply cord with this air conditioner contains a current detection device designed to reduce the risk of fire.

Please refer to the section 'Operation of Current Device' for details. In the event that the power supply cord is damaged, it cannot be repaired. It must be replaced with a cord from the product manufacturer.

## WARNING

Avoid fire hazard or electric shock. Do not use an extension cord or an adaptor plug. Do not remove any prong from the power cord.

### Grounding type wall receptacle

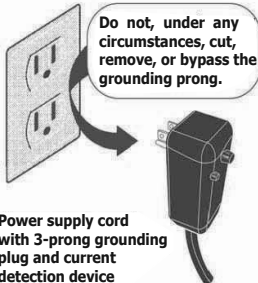

## WARNING

### For Your Safety

Do not store or use gasoline or other flammable vapors and liquids in the vicinity of this or any other appliance. Read product labels for flammability and other warnings.

## WARNING

### Prevent Accidents

To reduce the risk of fire, electrical shock, or injury to persons when using your air conditioner, follow basic precautions, including the following:

- Be sure the electrical service is adequate for the model you have chosen. This information can be found on the serial plate, which is located on the side of the cabinet.
- If the air conditioner is to be installed in a window, you will probably want to clean both sides of the glass first.
- Be sure the air conditioner has been securely and correctly installed according to the installation instructions in this manual. Save this manual for possible future use in removing or reinstalling this unit.

## WARNING

### Electrical Information

The complete electrical rating of your new portable air conditioner is stated on the serial plate. Refer to the rating when checking the electrical requirements.

- Be sure the air conditioner is properly grounded. To minimize shock and fire hazards, proper grounding is important. The power cord is equipped with a three-prong grounding plug for protection against shock hazards.
- Your air conditioner must be used in a properly grounded wall receptacle. If the wall receptacle you intend to use is not adequately grounded or protected by a time delay fuse or circuit breaker, have a qualified electrician install the proper receptacle.
- Do not run air conditioner without outside protective cover in place. This could result in mechanical damage within the air conditioner.
- **Do not use an extension cord or an adapter plug.**

## SAFETY PRECAUTIONS

### DANGER! Avoid Serious Injury or Death

- This air conditioner contains no user-serviceable parts. Always call an authorized Electrolux servicer for repairs.
- Do not insert or place fingers or objects into the air discharge area on top of the unit.
- Do not start or stop the air conditioner by unplugging the power cord or turning off the power at the electrical box.
- Do not cut or damage the power cord.
- If the power cord is damaged, it should only be replaced by an authorized Electrolux servicer.
- In the event of a malfunction (sparks, burning smell, etc.), immediately stop the operation, disconnect the power cord, and call an authorized Electrolux servicer.
- Do not operate the air conditioner with wet hands.
- Do not pull on the power cord.
- Do not drink any water that is drained from the air conditioner.

# Important Safety Instructions

## SAFETY PRECAUTIONS

### CAUTION! Avoid Injury or damage to the unit or other property

- Provide occasional ventilation during use. Do not direct airflow at fireplaces or other heat related sources as this could cause flare ups or make units run excessively.
- Do not climb on or place objects on the unit.
- Do not hang objects off the unit.
- Do not place containers with liquids on the unit.
- Turn off the air conditioner at the power source when it will not be used for an extended period of time.
- Periodically check the condition of the unit's installation accessories for any damage.
- Do not apply heavy pressure to the radiator fins of the unit.
- Operate the unit with air filter in place.
- Do not block or cover the intake grille, discharge area and outlet ports.
- Ensure that any electrical/electronic equipment is one yard away from the unit.
- Do not use or store flammable gases near the unit.

**READ THIS SECTION BEFORE ATTEMPTING TO OPERATE AIR CONDITIONER.**  
Unit must be upright for one hour prior to operating.

## Operation of Current Device

Plug in &  
press RESET

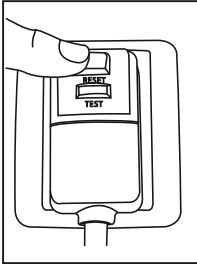

The power supply cord contains a current device that senses damage to the power cord. To test your power supply cord do the following:

1. Plug in the Air Conditioner.
2. The power supply cord will have TWO buttons on the plug head. Press the TEST button. You will notice a click as the RESET button pops out.
3. Press the RESET button. Again you will notice a click as the button engages.
4. The power supply cord is now supplying electricity to the unit. (On some model, this is also indicated by a light on the plug head)

### NOTE:

- Do not use this device to turn the unit on or off.
- Always make sure the RESET button is pushed in for correct operation.
- The power supply cord must be replaced if it fails to reset when either the TEST button is pushed, or it cannot be reset. A new one can be obtained from the product manufacturer.
- If power supply cord is damaged, it CANNOT be repaired. It MUST be replaced by one obtained from the product manufacturer.

# Product Registration & Normal Sounds

## Product Registration **Record Your Model and Serial Numbers**

Record in the space provided below the model and serial numbers. On all models, the serial plate is located on the side of the cabinet.

**Model No.** \_\_\_\_\_

**Serial No.** \_\_\_\_\_

### Register Your Product

The self-addressed PRODUCT REGISTRATION CARD should be filled in completely, signed and returned to the Frigidaire Company.

## Normal Sounds

### Sound of Rushing Air

At the front of the unit, you may hear the sound of rushing air being moved by the fan.

### Gurgles/Hiss

"Gurgling or hissing" noise may be heard due to refrigerant passing through evaporator during normal operation.

### High pitched Chatter

Today's high efficiency compressors may have a high pitched chatter during the cooling cycle.

### Vibration

Unit may vibrate and make noise because of uneven floor.

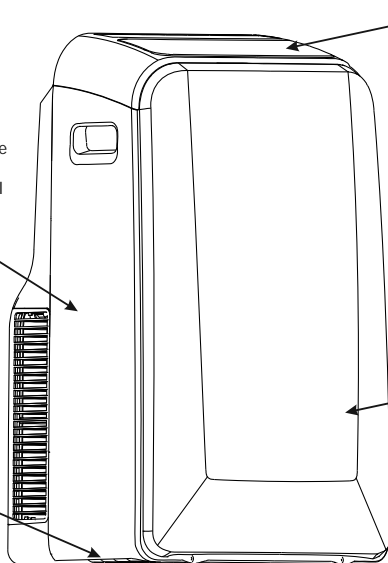

# Unit Description & Accessories Included

## Unit Description

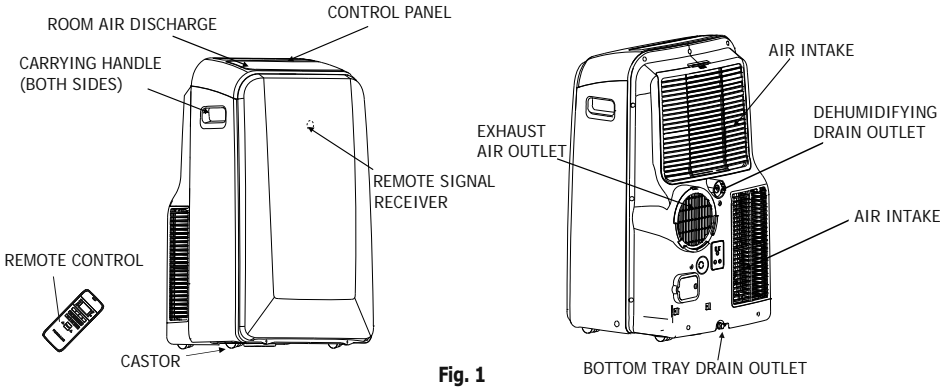

Fig. 1

## Accessories Included









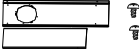

PARTS:	PARTS NAME:	QUANTITY:
	Exhaust hose	1 pc
	Unit/ Exhaust Adaptor A	1 pc
	Window/ Exhaust Adaptor B	1 pc
	Window Sliding Kit	1 set
	Foam Seal	3 pcs
	Remote Control	1 pc
	Battery (For remote control)	2 pcs
	1/2" Screw	4 pcs
	3/4" Screw	2 pcs
	1/2" Hex Head Cap Screw	2 pcs
	Safety Lock	1 pc

Fig. 2

- Check all the accessories are included in the package and please refer to the installation instructions for their usage.

# Installation Instructions

## Installation Instructions

### EXHAUSTING HOT AIR

In the COOLING Mode the appliance must be placed close to a window or opening so that the warm exhaust air can be ducted outside.

First position unit on a flat floor and make sure there's a minimum of 12" clearance around the unit, and is within the vicinity of a single circuit outlet power source.

1. Extend either side of the hose (Fig. 3) and screw the hose to adaptor A (Fig. 4).
2. Extend the other side of the hose and screw it to adaptor B (Fig. 5).
3. Slide the assembly onto unit (Fig. 6).
4. Affix the adaptor B into the window slider kit and seal. (Fig. 7&8)

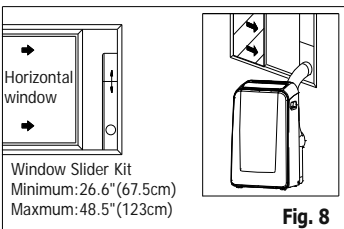
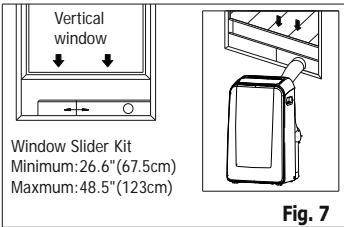
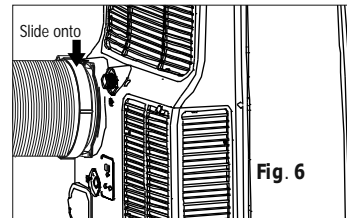
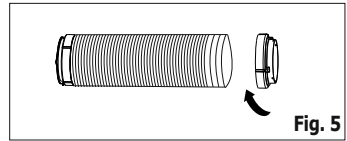
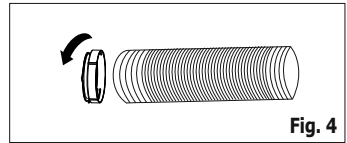
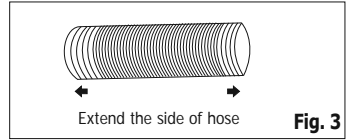

The hose can be extended from its original length of 15" up to 59", but it is the best to keep the length to minimum required. Also make sure that the hose does not have any sharp bends or sags. (Fig. 9)

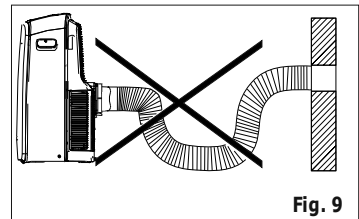

## Installation Instructions (continued)

### Installation in a double-hung sash window

1. Cut the foam seals(adhesive type) to the proper lengths and attach them to the window and stool. (Fig. 10)
2. Open the window sash and place the window slider kit on the window stool (Fig. 11). Attach the window slider kit to the window stool. Adjust the length of the window slider kit according to the width of window. Screw down the two screws on the window slider kit. See Fig.11. Cut the adjustable window slider kit if the width of window is less than 26.6 inches (Fig. 12).
3. Close the window sash securely against the window slider kit. (Fig. 13)
4. Drive two 1/2" screws to secure the window slider kit to the window sash. (FIG. 13)
5. Secure the window slider kit to the window stool (FIG. 13):  
A: For wooden windows: Use 3/4" screws for securing.  
B: For Vinyl-Clad windows: Use 1/2" hex head cap screws for securing.
6. To secure lower sash in place, attach right angle sash lock with 1/2" (12.7mm) screw as shown (FIG. 14).

NOTE: It is difficult to lock the windows with the sash lock for Vinyl-Clad windows, so you can use lock by window itself.

7. Cut the foam seal to an appropriate length and seal the open gap between the top window sash and outer window sash, as shown in Fig.15.

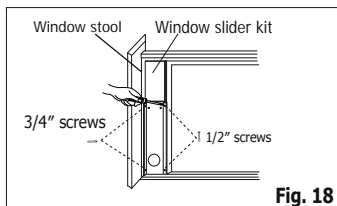
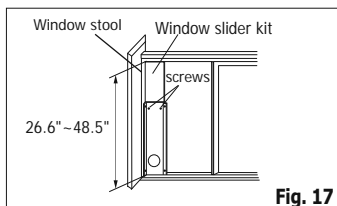
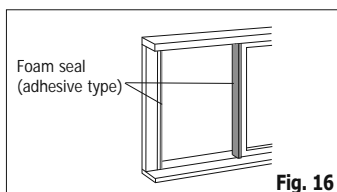
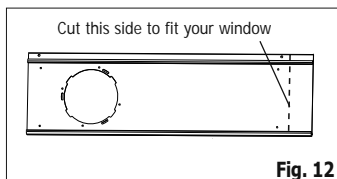
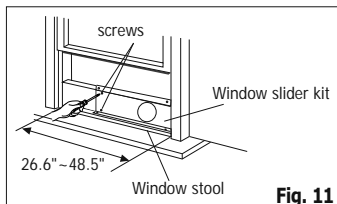
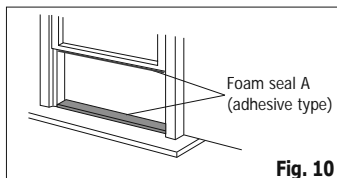
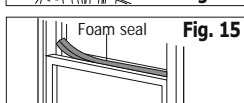
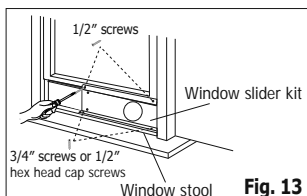

### Installation in a sliding sash window

1. Cut the foam seals(adhesive type) to the proper lengths and attach them to the window frame. See Fig.16.
2. Open the window sash and place the window slider kit on the window stool. See Fig.17. Attach the window slider kit to the window stool. Adjust the length of the window slider kit according to the height of window. Screw down the two screws on the window slider kit. See Fig.17. Cut the adjustable window slider kit if the height of window is less than 26.6 inches (Fig. 12).
3. Close the sliding sash securely against the window slider kit. (Fig. 18)
4. Drive two 1/2" screws to secure the window slider kit to the window sash. (Fig. 18)
5. Drive two 3/4" screws to secure the window slider kit to the window stool. (Fig. 18)
6. Cut the foam seal to an appropriate length and seal the open gap between the sliding sash and outer window sash, as shown in Fig.19.
7. To secure the sliding sash in place, attach right angle sash lock with 1/2" (12.7mm) screw as shown.(Fig.20)

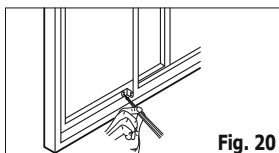
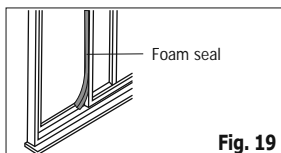

# Air Conditioner Features

## Air Conditioner Features

### CONTROL PANEL

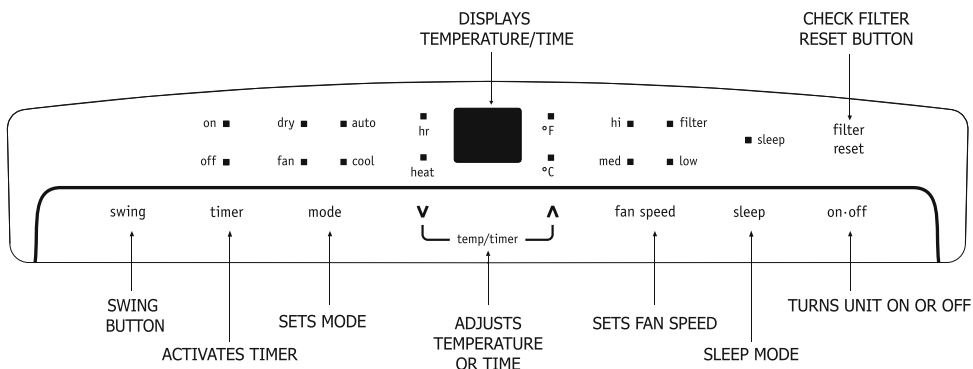

Fig. 21

### REMOTE CONTROL

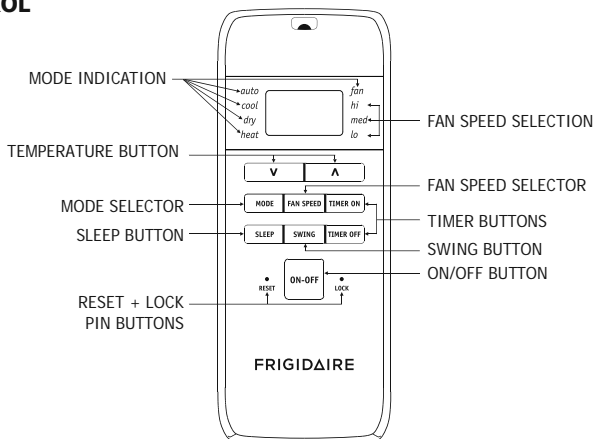

Fig. 22

#### Battery Size: AAA

**Warning:** 1. Do not mix old and new batteries. Do not mix alkaline, standard (carbon-zinc), or rechargeable (nickel-cadmium) batteries.

2. This device complies with Part 15 of the FCC Rules. Operation is subject to the following two conditions: (1) This device may not cause harmful interference, and (2) this device must accept any interference received, including interference that may cause undesired operation.

#### NOTE

- The RESET button is depressed when you want to return to the initial factory settings. The LOCK button is depressed to lock the keypad so the settings cannot be changed. The key symbol will appear in the display of the remote control, depress the LOCK button again to release. Use a small pin to depress these buttons.
- Heating function is for heating and cooling model only.



## Operating Instructions

### NOTE

The following instructions represent the Control Panel, the same instructions can be used for the Remote Control. (except timer function)

<b>COOLING MODE:</b>	<p><b>In this mode the exhaust adaptor hose MUST be used.</b></p> <ol style="list-style-type: none"><li>1. Press the MODE button until the "Cool" indicator lights.</li><li>2. Press the " <b>▼ ▲</b> " Temp buttons for desired setting.</li><li>3. Press the FAN button for desired fan speed.</li></ol>
<b>HEATING MODE: (on some models)</b>	<p><b>In this mode you do not need to use the exhaust adaptor hose.</b></p> <ol style="list-style-type: none"><li>1. Press the MODE button until the "Heat" indicator lights.</li><li>2. Press the " <b>▼ ▲</b> " Temp buttons for the desired heat setting. Under Heating mode, you can not select the fan speed.</li></ol>
<b>DRY MODE:</b>	<p><b>In this mode you do not need to use the exhaust adaptor hose, BUT the water collected must be discharged. See Drainage Section.</b></p> <ol style="list-style-type: none"><li>1. Press the MODE button until the "Dry" indicator lights.</li><li>2. The fan will run at low speed and the display will show the room temperature.</li><li>3. Keep doors &amp; windows closed for best effect.</li></ol>
<b>AUTO MODE:</b>	<p><b>Always have the exhaust hose attached in this mode.</b></p> <p>When you set the air conditioner in AUTO mode, it will automatically select cooling, heating(not applicable for cooling only models), or fan only operation depending on what temperature you have selected and the room temperature. The air conditioner will control room temperature automatically round the temperature point set by you. Under AUTO mode, you can not select the fan speed.</p>
<b>FAN MODE:</b>	<p><b>In this mode there is no need to use the exhaust hose or drainage hose. However, if you require stale or smokey air to be removed from the room, hook up the duct accessories as described in the "EXHAUSTING HOT AIR" section.</b></p> <ol style="list-style-type: none"><li>1. Press the MODE button until the "Fan" indicator lights.</li><li>2. Press the FAN button to choose the desired fan speed.</li><li>3. The fan will run at the selected speed and the display will show the room temperature.</li></ol>
<b>TIMER OPERATION:</b>	<p>You can set both delay stop and delay start while unit is in ON position or OFF position. When unit is in ON position, first press TIMER button to go to delay stop setting, then "timer off" light will illuminate, tap or hold the UP arrow (<b>▲</b>) or the DOWN arrow (<b>▼</b>) to change delay stop timer at 0.5 hour increments up to 10 hours, then at 1 hour increments up to 24 hours. Then press the TIMER button to confirm the setting (the control will confirm the setting automatically after 5 seconds) and go to delay start setting. Use the same way as above to set the delay start timing. If you don't need to set delay start, press the TIMER button again to exit. After 5 seconds, the control will automatically change the display back to previous temperature display. If you want to check remain timing, press the TIMER button. The delay start operation automatically selects mode, temperature and fan speed the same as last operation you set.</p> <p>When unit is in OFF position, press TIMER button will first go to delay start setting, then "timer on" light will illuminate, set the delay start and delay stop timing the same way as above.</p> <p>To cancel the timer setting, simply tap (<b>▲</b>) or (<b>▼</b>) button to change the timing to 0.0.</p> <p>You can set both delay stop and delay start by using the remote control, while unit is in ON position or OFF position. To set the delay stop timing, first press TIMER OFF button on the remote control to go to delay stop setting, then tap or hold the TIMER OFF button to change delay stop timer at 0.5 hour increments up to 10 hours, then at 1 hour increments up to 24 hours. After the desired setting is reached stop pressing the TIMER OFF button, the control will confirm the setting automatically after 5 seconds and change the display back to previous</p>

# Operating Instructions

## Operating Instructions

(continued)

temperature display. Use the same way as above to set the delay start timing by pressing TIMER ON button. To cancel the timer setting, simply tap TIMER ON or TIMER OFF button to change the timing to 0.0.

### SLEEP OPERATION:

In this mode the selected temperature will increase by 2 °F 30 minutes after the mode is selected. The temperature will then increase by another 2 °F after an additional 30 minutes. This new temperature will be maintained for 7 hours before it returns to the originally selected temperature. This ends the "Sleep" mode and the unit will continue to operate as originally programmed. The "Sleep" mode program can be cancelled at any time during operation by again pressing the "Sleep" button.

**Note:** This feature is unavailable under FAN or DRY modes.

### SWING OPERATION:

When you turn on the unit, the louver will swing and stop at a certain angle. You can press the SWING button to let the louver swing automatically. Press the SWING button again while you want the louver stop at desired angle.

### CHECK FILTER FEATURE:

This feature is a reminder to clean the Air Filter (See Care and Cleaning) for more efficient operation. The filter indicator will illuminate after 250 hours of operation. To reset after cleaning the filter, press the "Filter" button and the light will go off.

### SELECTING FAN SPEED:

You can select the desired fan speed, by pressing the FAN SPEED button. The fan speed will change in the sequence as the drawing on the left.



**NOTE:** After choosing the fan speed as "LOW", "MED" or "HIGH", the corresponding fan speed indicator light will illuminate. After the AUTO fan speed is selected, no fan speed indicator light will illuminate. Under AUTO, Heat, Dry mode, you can not select the fan speed.

### FAULT CODE:



If the display reads "EA", the room temperature sensor has failed. Contact your Authorized Frigidaire Service Center.



If the display reads "ES", the evaporator temperature sensor has failed. Contact your Authorized Frigidaire Service Center.



If the display reads "E4", the display panel communication has failed. Contact your Authorized Frigidaire Service Center.



If the display reads "P1", bottom tray is full. Carefully move the unit to a drain location, remove the bottom drain plug and let the water drain away. Restart the machine until the "P1" symbol disappears. If error repeats, call for service.

### DRAINAGE:

During the dehumidifying mode, you will need a garden hose (sold separately) to drain the condensate from the unit.

Remove the rubber stopper from the hose connector, then screw on a garden hose to the connector as shown on fig 23.

The hose may then:

- Discharge into a drain that is lower than the unit.
- Be connected to a condensate pump (sold separately).
- During cooling mode, please replace the rubber stopper to the hose connector to reach the maximum performance.

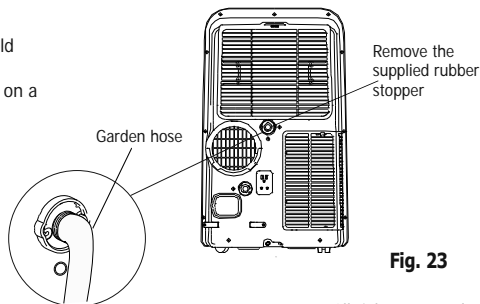

Fig. 23

# Operating Instructions, CARE & CLEANING

## Operating Instructions (continued)

### ADDITIONAL THINGS YOU SHOULD KNOW

Now that you have mastered the operating procedure, here are more features in your control that you should become familiar with.

- The "Cool" circuit has an automatic 3 minute time delayed start if the unit is turned off and on quickly. This prevents overheating of the compressor and possible circuit breaker tripping. The fan will continue to run during this time.
- Temperature can be set between 62 °F and 86 °F (17 °C and 30 °C).
- The control is capable of displaying temperature in degrees Fahrenheit or degrees Celsius. To convert from one to the other and back, press and hold the "TEMP" Up (▲) and Down (▼) buttons together for 3 seconds.
- There is a 2-Second delay for the compressor shutting down when selecting FAN ONLY/HEAT. This is to cover the possibility of having to roll through to select another mode.
- After a power outage, the unit will memorize the last setting and return the unit to the same setting once power is restored.
- Indoor operating temperature range for this product is 62 °F to 95 °F (17 °C to 35 °C).

## CARE & CLEANING

Clean your air conditioner occasionally to keep it looking new. **Be sure to unplug the unit before cleaning to prevent shock or fire hazards.**

### Air Filter Cleaning

- This unit has two filters, they are filter A and B. Grasp the upper panel tab and take off the filter A which is behind the grill of the back panel (Fig.24). Remove the lower filter B by loosening the screws. Take down the air inlet grille, then remove the air filter as shown in Fig.25 & 26.
- Wash the filter using liquid dishwashing detergent and warm water. Rinse filter thoroughly. Gently shake excess water from the filter. Be sure filter is thoroughly dry before replacing.
- Or, instead of washing you may vacuum the filter clean.
- Replace the filter after the filter is dry.

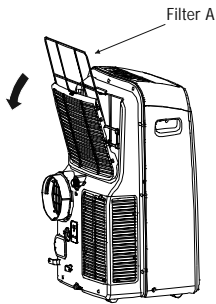

### Cabinet Cleaning

- Be sure to unplug the air conditioner to prevent shock or fire hazard. The cabinet and front may be dusted with an oil-free cloth or washed with a cloth dampened in a solution of warm water and mild liquid dishwashing detergent. Rinse thoroughly and wipe dry.
- Never use harsh cleaners, wax or polish on the cabinet front.
- Be sure to wring excess water from the cloth before wiping around the controls. Excess water in or around the controls may cause damage to the air conditioner.

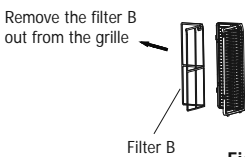
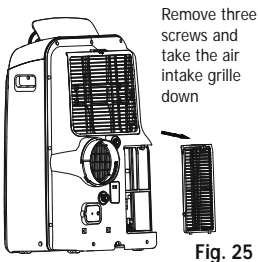

### Winter Storage

If you plan to store the appliance during the winter, cover it with plastic or return it to its carton.

# Before You Call

Before calling for service, review this list. It may save you time and expense. This list includes common occurrences that are not the result of defective workmanship or materials in this appliance.

<b>OCCURRENCE</b>	<b>SOLUTION</b>
<b>Air conditioner will not operate.</b>	Wall plug disconnected. Push plug firmly into wall outlet.
	Plug Current Device Tripped. Press the RESET button.
	House fuse blown or circuit breaker tripped. Replace fuse with time delay type or reset circuit breaker.
	Control is OFF. Turn Control ON and set to desired setting.
	P1 appears in the display window. Drain water as described in Drainage Section.
	Shut off in Heat mode. When the air outlet exceeds 158 °F (70 °C), the automatic heat protection engages. Remove any blockages and let appliance cool down.
Room Temperature lower than the set temperature (Cool Mode). Reset the temperature.	
Room Temperature higher than the set temperature (Heat Mode). Reset the temperature.	
<b>Air from unit does not feel cold enough.</b>	Room temperature below 60°F (16°C). Cooling may not occur until room temperature rises above 60°F (16°C).
	Reset to a lower temperature.
	Compressor shut-off by changing modes. Wait approximately 3 minutes and listen for compressor to restart when set in the COOL mode.
<b>Air conditioner cooling, but room is too warm - ice forming on cooling coil behind decorative front</b>	Outdoor temperature below 60 °F (16 °C). To defrost the coil, set FAN ONLY mode.
	Air filter may be dirty. Clean filter. Refer to Care and Cleaning section. To defrost, set to FAN ONLY mode.
	Temperature is set too low for night-time cooling. To defrost the coil, set to FAN ONLY mode. Then, set temperature to a higher setting.
	Exhaust duct not connected or blocked. See EXHAUSTING HOT AIR Section.
<b>Air conditioner cooling, but room is too warm - NO ice forming on cooling coil behind decorative front.</b>	Dirty air filter - air restricted. Clean air filter. Refer to Care and Cleaning section.
	Temperature is set too high. Set temperature to a lower setting.
	Air directional louvers positioned improperly. Position louvers for better air distribution.
	Front of unit is blocked by drapes, blinds, furniture, etc. - restricts air distribution. Clear blockage in front of unit.
	Doors, windows, registers, etc. open - cool air escapes. Close doors, windows, registers, etc.
	Unit recently turned on in hot room. Allow additional time to remove "stored heat" from walls, ceiling, floor and furniture.
<b>Air conditioner turns on and off rapidly.</b>	Dirty air filter - air restricted. Clean air filter.
	Outside temperature extremely hot. Set FAN speed to a faster setting to bring air through cooling coils more frequently.
<b>Noise when unit is cooling.</b>	Air movement sound. This is normal. If too loud, set to lower FAN setting.
	Vibration from uneven floor. Move or support appliance correctly on even surface.
<b>Room too cold.</b>	Set temperature too low. Increase set temperature.
<b>Room Too Hot.</b>	Set temperature too high. Lower setting.

**If These Solutions Fail, Call 1-800-944-9044(US)/1-800-265-8352(Canada) For Frigidaire Service.**

# Major Appliance Limited Warranty

Your appliance is covered by a limited one-year warranty and a limited 2-5 year warranty on the sealed system (the compressor, condenser, evaporator and tubing). For one year from your original date of purchase, Electrolux will pay all costs for repairing or replacing any parts of this appliance that prove to be defective in materials or workmanship when such appliance is installed, used and maintained in accordance with the provided instructions. From the second to the fifth year from your original purchase date, Electrolux will repair or replace any parts in the Sealed Refrigeration System (compressor, condenser, evaporator and tubing) that prove to be defective in materials or workmanship. In years 2-5, the consumer will be responsible for diagnostic, labor and parts costs as well as any removal, transportation and reinstallation expenses which are incurred during service on components other than those covered under the Sealed Refrigeration System 5-year warranty.

## **Exclusions This warranty does not cover the following:**

1. Products with original serial numbers that have been removed, altered or cannot be readily determined.
2. Product that has been transferred from its original owner to another party or removed outside the USA or Canada.
3. Rust on the interior or exterior of the unit.
4. Products purchased "as-is" are not covered by this warranty.
5. Food loss due to any refrigerator or freezer failures.
6. Products used in a commercial setting.
7. Service calls which do not involve malfunction or defects in materials or workmanship, or for appliances not in ordinary household use or used other than in accordance with the provided instructions.
8. Service calls to correct the installation of your appliance or to instruct you how to use your appliance.
9. Expenses for making the appliance accessible for servicing, such as removal of trim, cupboards, shelves, etc., which are not a part of the appliance when it is shipped from the factory.
10. Service calls to repair or replace appliance light bulbs, air filters, water filters, other consumables, or knobs, handles, or other cosmetic parts.
11. Surcharges including, but not limited to, any after hour, weekend, or holiday service calls, tolls, ferry trip charges, or mileage expense for service calls to remote areas, including the state of Alaska.
12. Damages to the finish of appliance or home incurred during installation, including but not limited to floors, cabinets, walls, etc.
13. Damages caused by: services performed by unauthorized service companies; use of parts other than genuine Electrolux parts or parts obtained from persons other than authorized service companies; or external causes such as abuse, misuse, inadequate power supply, accidents, fires, or acts of God.

## **DISCLAIMER OF IMPLIED WARRANTIES; LIMITATION OF REMEDIES**

CUSTOMER'S SOLE AND EXCLUSIVE REMEDY UNDER THIS LIMITED WARRANTY SHALL BE PRODUCT REPAIR OR REPLACEMENT AS PROVIDED HEREIN. CLAIMS BASED ON IMPLIED WARRANTIES, INCLUDING WARRANTIES OF MERCHANTABILITY OR FITNESS FOR A PARTICULAR PURPOSE, ARE LIMITED TO ONE YEAR OR THE SHORTEST PERIOD ALLOWED BY LAW, BUT NOT LESS THAN ONE YEAR. ELECTROLUX SHALL NOT BE LIABLE FOR CONSEQUENTIAL OR INCIDENTAL DAMAGES SUCH AS PROPERTY DAMAGE AND INCIDENTAL EXPENSES RESULTING FROM ANY BREACH OF THIS WRITTEN LIMITED WARRANTY OR ANY IMPLIED WARRANTY. SOME STATES AND PROVINCES DO NOT ALLOW THE EXCLUSION OR LIMITATION OF INCIDENTAL OR CONSEQUENTIAL DAMAGES, OR LIMITATIONS ON THE DURATION OF IMPLIED WARRANTIES, SO THESE LIMITATIONS OR EXCLUSIONS MAY NOT APPLY TO YOU. THIS WRITTEN WARRANTY GIVES YOU SPECIFIC LEGAL RIGHTS. YOU MAY ALSO HAVE OTHER RIGHTS THAT VARY FROM STATE TO STATE.

**If You Need Service** Keep your receipt, delivery slip, or some other appropriate payment record to establish the warranty period should service be required. If service is performed, it is in your best interest to obtain and keep all receipts. Service under this warranty must be obtained by contacting Electrolux at the addresses or phone numbers below.

This limited warranty only applies in the USA and Canada. In the USA, your appliance is warranted by Electrolux Major Appliances North America, a division of Electrolux Home Products, Inc. In Canada, your appliance is warranted by Electrolux Canada Corp. Electrolux authorizes no person to change or add to any obligations under this warranty. Obligations for service and parts under this warranty must be performed by Electrolux or an authorized service company. Product features or specifications as described or illustrated are subject to change without notice.

**USA**  
**1.800.944.9044**  
Electrolux Major Appliances  
10200 David Taylor Drive  
Charlotte, NC 28262



**Electrolux**

**Canada**  
**1.800.265.8352**  
Electrolux Canada Corp.  
5855 Terry Fox Way  
Mississauga, Ontario, Canada  
L5V 3E4