

Civik / technical data sheet

Civik staircase is powder-coated for interior installation, with a universal landing allowing installation into a mezzanine, round or square opening.

Civik height is adjustable from 99 3/16" to 120 1/16" (from 252 to 305 cm).

STEEL COLORS

GREY,
WHITE OR BLACK



Table 1

		ADDITIONAL ARTICLES			
	STAIRCASE HEIGHT	RISERS	TREADS	POLES	HANDRAILS
INCREASE ▲	132 5/16" ÷ 148 1/16" 336 ÷ 376 cm	16	+ 3	+ 1	+ 1
	124" ÷ 138 9/16" 315 ÷ 352 cm	15	+ 2	+ 2*	+ 1
	115 3/4" ÷ 129 1/2" 294 ÷ 329 cm	14	+ 1	-	-
STANDARD	107 1/2" ÷ 120 1/16" 273 ÷ 305 cm	13	12 TREADS + 1 UNIVERSAL LANDING + RAILING WITH VERTICAL BALUSTERS		
DECREASE ▼	99 3/16" ÷ 111" 252 ÷ 282 cm	12	-	-	-
	90 15/16" ÷ 101 9/16" 231 ÷ 258 cm	11	-	+ 1*	-
	82 11/16" ÷ 92 1/2" 210 ÷ 235 cm	10	-	+ 1*	-



ADJUSTABLE RISE FROM 8 9/32" TO 9 1/4" (FROM 21 TO 23,5 CM)

* REPLACES THE EXISTING 49 3/16" (125 CM) POLE IN THE CIVIK STAIRCASE.

D 47 1/4" (Ø 120 cm)

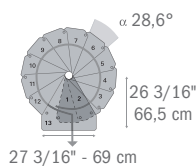

D 55 1/8" (Ø 140 cm)

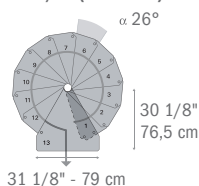

D 63" (Ø 160 cm)

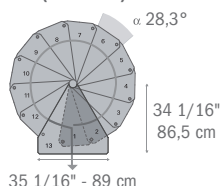



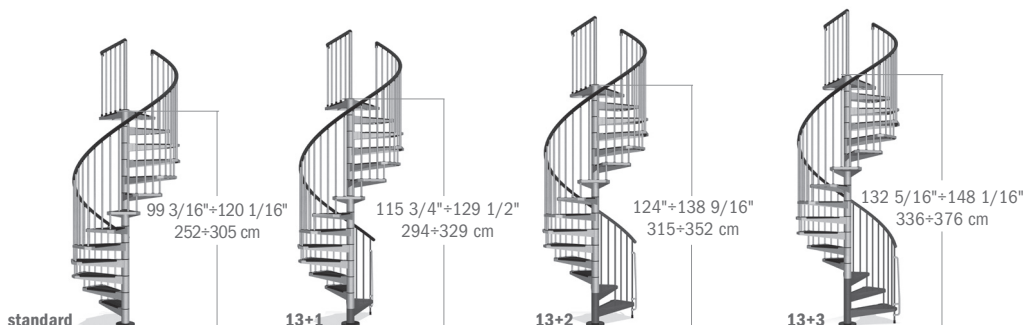

DIAMETERS

The diameters of the staircase are 47 1/4", 55 1/8" e 63" (120, 140 e 160 cm). The recommended opening in the floor is at least 2" (5 cm) larger than the diameter of the staircase. Example: D staircase 47 1/4" (Ø 120 cm) = D ceiling opening 49 1/4" (Ø 125 cm).



ADDITIONAL ARTICLES OVERVIEW

				
TREAD	RISER BAR	POLE 32 5/16" (82 CM)	HANDRAIL 47 1/4" (120 CM)	BALCONY RAIL KIT 47 1/4" (120 CM)

ADDITIONAL TREADS / POLES / HANDRAILS

To reach a staircase height of 148 1/16" (376 cm), you must purchase additional treads comprising the structure, tread and balusters.

Additional pole and handrail modules (Table 1) must be purchased for certain configurations.

RISER BAR

Allows to reduce the space between treads for safety.



WINDING DIRECTION

The clockwise or counterclockwise winding direction may be decided during the assembly.



clockwise



counterclockwise

BALCONY RAIL KIT

The additional balcony rail kit is necessary to protect the upper floor opening (fig. 1, 2, 3). It comes in 47 1/4" (120 cm) modules comprising 10 balusters, handrail and hardware. This kit can be used for a square as well as a circular opening (fig. 2).

The D 63" (Ø 160 cm) Civic complies to the: **INTERNATIONAL RESIDENTIAL CODE 2012 - STAIR BUILDING CODE**

Rise from 8 9/32" to 9 1/4" (21 to 23,5 cm)

Minimum run at 12" (30,5 cm) from the narrow edge: 7 1/2" (19 cm)

Clear width: 26 15/16" (68,5 cm)

Distance between railing balusters:

4" (10,2 cm)

TYPES OF OPENINGS AND RAILINGS

mezzanine

fig. 1

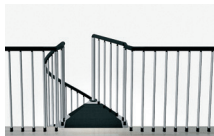

round opening

fig. 2



square opening

fig. 3

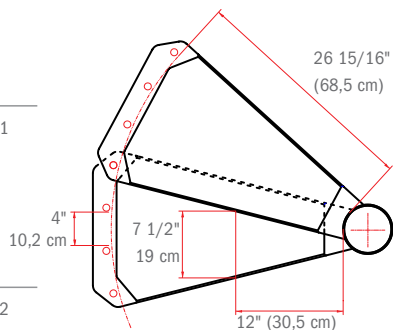

EXAMPLE

If you wish to purchase CIVIK comprising 13 + 3 = 16 risers, the following articles are needed:

- 1 CIVIK STAIRCASE (standard)
- 3 ADDITIONAL TREADS
- 1 ADDITIONAL POLE (32 5/16" / 82 cm)
- 1 ADDITIONAL HANDRAIL



FOR FURTHER INFORMATION
VISIT THE WEBSITE
www.arkestairs.com

fontanot
arke