

HOME DECORATORS COLLECTION

Instant Pendant Light/Recessed Light Conversion Kit

Assembly Instructions

HDC#: 8188200280 MFG#: PKN-8062-8011

Please read over the instructions, it will be a time-saver in the long run.

PACKAGE CONTENTS

Part	Description	Quantity
A	Socket adapter	1
B	Spindle bracket	1
C	Canopy *	1
D	Compression nut	1
E	Socket ring	1
F	Shade *	1
G	Lamp cup *	1
H	Decorative ring *	1

* Style and finish will vary by item.

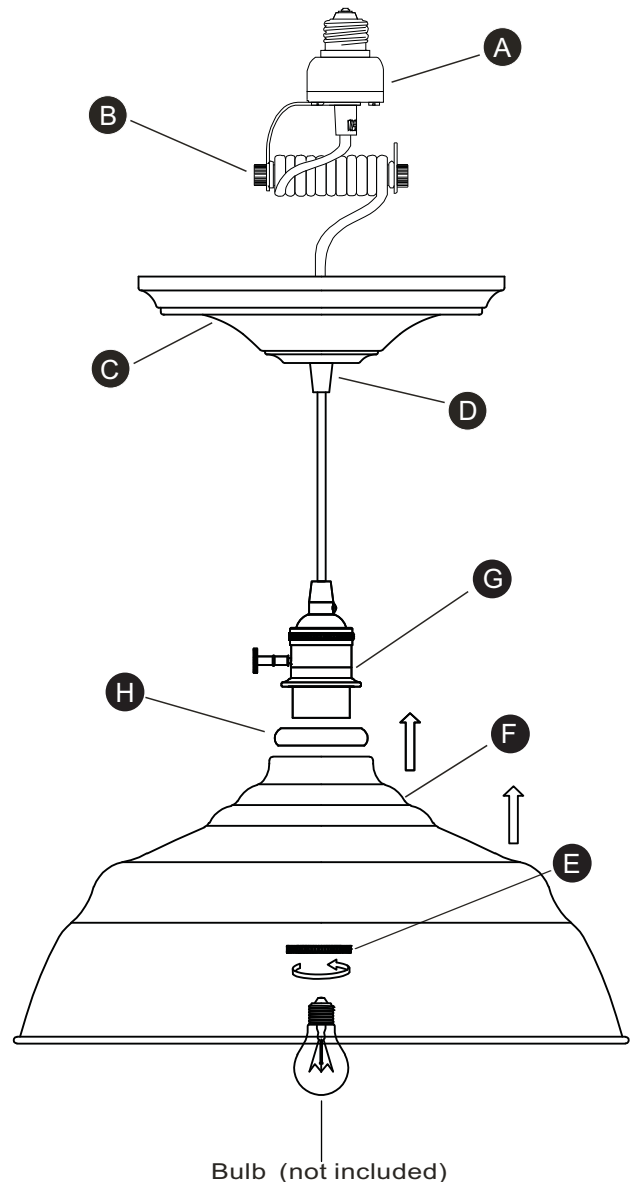

Questions, problems, missing parts? Before returning to your retailer, call our customer service department at 1-866-384-9400, 9 a.m.-5 p.m., EST, Monday-Friday. Include e-mail address if applicable.



PREPARATION

Before beginning assembly of product, make sure all parts are present. Compare parts with package contents list and diagram above. If any part is missing or damaged. Do not attempt to assemble the product. Contact customer service for replacement parts.

Estimated Assembly Time: 10-15 minutes
Helpful Tools:

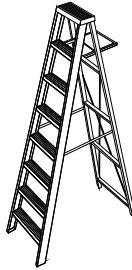

ASSEMBLY INSTRUCTIONS

1. Adjust excess cord by wrapping it around spindle bracket (B) just below the socket adapter (A). Position the last wrap so the cord will hang in the center of your recessed light fixture.

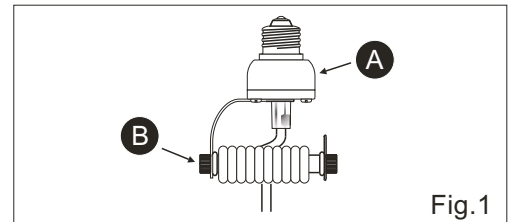

2. Screw the adapter (A) into the light bulb socket in your recessed light fixture.

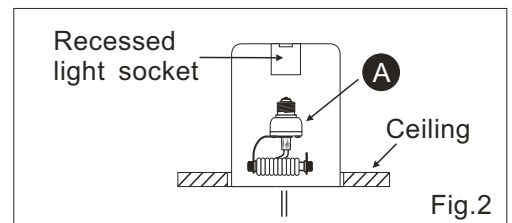

3. After finger loosening the compression nut (D) by turning it counter-clockwise, slide the canopy (C) up the cord and against the ceiling.

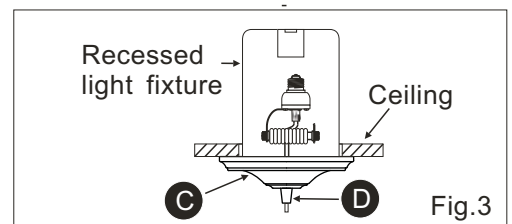

4. To hold the canopy in place against the ceiling, finger tighten the compression nut (D) by turning it clockwise.

⚠ CAUTION: Do not over-tighten the compression nut (D).

HELPFUL HINT: If the canopy does not sit tight against the ceiling, loosen the compression nut (D). GENTLY pull down on the cord to flex the spring arm (B), then slide the canopy (C), back up and re-tighten.

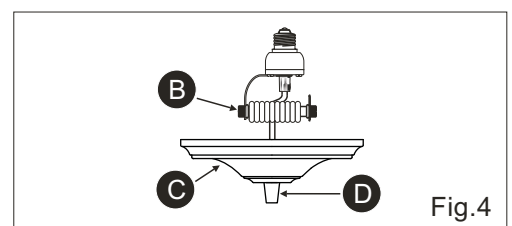

5. Attach shade (F) to Lamp cup (G) through decorative ring (H) and then screw on the Socket ring (E) clockwise until tight.

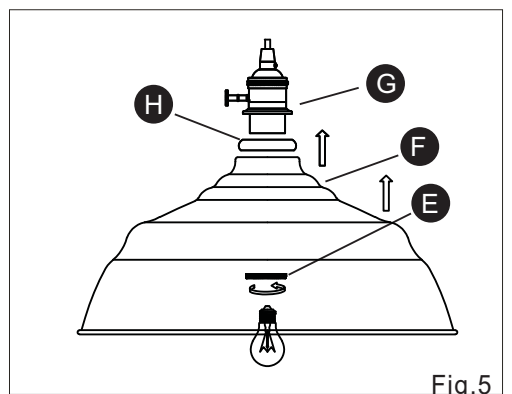

CARE AND MAINTENANCE

Shut off light and let bulb and glass shade cool if necessary. Wipe glass shade with soft cloth or household glass cleaner. Do not use abrasive cleaners. For replacement bulbs, use 75 watt maximum, Type A or suitable medium base bulb (not included) including CFL bulbs.

WARNINGS AND CAUTIONS

WARNING

- Risk of fire or electrical shock. Do not alter, relocate, or remove wiring, lampholders, ballasts, or any other electrical component.
- Risk of fire or electrical shock. Install this kit only in the luminaries that have the construction features and dimensions shown in the photographs and/or drawings.

CAUTION

- Do not make or alter any open holes in an enclosure of wiring or electrical components during kit installation.

TROUBLESHOOTING

Problem	Possible Cause	Corrective Action
Canopy does not fit tight against the ceiling	Cord has stretched out	Loosen the compression nut (D) and GENTLY pull down on the cord to flex the spring arm (B), then slide the canopy (C) back up and re-tighten
Bulb will not light	Bulb is burned out Power is off Bad switch	Replace light bulb (not included) Make sure power supply is on Test or replace switch

WARRANTY

The manufacturer warrants against defects in materials and workmanship for one (1) year from the date of purchase to the original purchaser. If within this period the product is found to be defective, take a copy of the bill of sale as a proof of purchase and the product in its original packaging to the place of purchase. This warranty does not cover products becoming damaged or defective caused by abuse, misuse, accidents, faulty installation, improper handling and/or maintenance, or repairs not carried out by the manufacturer. Items which are not covered by warranty are those considered as parts which are prone to failure due to general wear and tear (for example, lamps, fuses, glass materials). There will be no obligations or liability on the part of the manufacturer for consequential damages arising from the use of the product or any indirect damages with respect to loss of property, revenue, or costs for removal. Installation or the use of the product or any indirect damages with respect to loss of property, revenue, or costs for removal, re-installation. As some states do not allow exclusions of limitations on an implied warranty, the above exclusion and limitation may not apply. This warranty gives you specific rights and you may also have other rights which may vary from state to state.